



# **LevelOne**

## **FSW-1609TFX**

## **FSW-2409TFX**

**16/24-Port Fast Ethernet Switch  
w/ fiber module slot**

# **User Manual**

**Version 1.1-0609**



## FCC Warning

This equipment has been tested and found to comply with the regulations for a Class B digital device, pursuant to Part 15 of the FCC Rules. These limits are designed to provide reasonable protection against harmful interference when the equipment is operated in a commercial environment. This equipment generates, uses, and can radiate radio frequency energy and, if not installed and used in accordance with this user's guide, may cause harmful interference to radio communications. Operation of this equipment in a residential area is likely to cause harmful interference, in which case the user will be required to correct the interference at his own expense.

## CE Mark Warning

This is a Class B product. In a domestic environment, this product may cause radio interference, in which case the user may be required to take adequate measures.



# TABLE OF CONTENTS

---

<b>ABOUT THIS GUIDE</b> .....	<b>1</b>
PURPOSE .....	1
TERMS/USAGE .....	1
OVERVIEW OF THIS USER'S GUIDE .....	2
<b>INTRODUCTION</b> .....	<b>3</b>
FAST ETHERNET TECHNOLOGY .....	3
SWITCHING TECHNOLOGY .....	4
FEATURES .....	5
<b>UNPACKING AND INSTALLATION</b> .....	<b>8</b>
UNPACKING .....	8
INSTALLATION .....	9
100BASE-FX MODULE INSTALLATION .....	10
RACK MOUNTING .....	11
FRONT PANEL .....	13
REAR PANEL .....	14
LED INDICATORS .....	15
<b>CONNECTING THE SWITCH</b> .....	<b>16</b>
PC TO SWITCH .....	16
HUB TO SWITCH.....	17
A. 10BASE-T Hub.....	17
B. 100BASE-TX Hub .....	17
SWITCH TO SWITCH (OTHER DEVICES) .....	18
A. Using straight cable.....	18
B. Using crossover cable .....	18
PORT SPEED & DUPLEX MODE .....	19
<b>TECHNICAL SPECIFICATIONS</b> .....	<b>20</b>
<b>RJ-45 PIN SPECIFICATION</b> .....	<b>22</b>

---

## ***ABOUT THIS GUIDE***

---

Congratulations on your purchase of the LevelOne FSW-1609/2409TFX 16/24-Port 10/100Mbps Fast Ethernet Switch. This device integrates 100Mbps Fast Ethernet and 10Mbps Ethernet network capabilities in a highly flexible package.

---

### **Purpose**

---

This guide discusses how to install your LevelOne 16/24Port 10/100Mbps Fast Ethernet Switch.

---

### **Terms/Usage**

---

In this guide, the term “**Switch**” (first letter upper case) refers to your LevelOne 16/24-Port 10/100Mbps Fast Ethernet Switch, and “**switch**” (first letter lower case) refers to other Ethernet switches.

This guide provides the information you need to install and configure the following models of the Switch:

- LevelOne FSW-1609TFX 16-Port 10/100Mbps Fast Ethernet Switch
- LevelOne FSW-2409TFX 24-Port 10/100Mbps Fast Ethernet Switch

The functionality of three units is identical, except for the number of ports. Where appropriate, differences between the two units are noted.

---

## Overview of this User's Guide

---

Chapter 1, *Introduction*. Describes the Switch and its features.

Chapter 2, *Unpacking and Installation*. Helps you get started with the basic installation of the Switch.

Chapter 3, *Identifying External Components*. Describes the front panel, rear panel and LED indicators of the Switch.

Chapter 4, *Connecting the Switch*. Tells how you can connect the Switch to your Ethernet network.

Appendix A, *Technical Specifications*. Lists the technical (general, physical and environmental, and performance) specifications of the Switch.

Appendix B, *RJ-45 Pin Specification*. Describes the RJ-45 receptacle/connector and the straight and crossover cable connector.

# ***INTRODUCTION***

---

This chapter describes the features of the Switch and some background information about Ethernet/Fast Ethernet switching technology.

---

## **Fast Ethernet Technology**

---

The growing importance of LANs and the increasing complexity of desktop computing applications are fueling the need for high performance networks. A number of high-speed LAN technologies have been proposed to provide greater bandwidth and improve client/server response times. Among them, 100BASE-T (Fast Ethernet) provides a non-disruptive, smooth evolution from the current 10BASE-T technology. The non-disruptive and smooth evolution nature, and the dominating potential market base, virtually guarantee cost effective and high performance Fast Ethernet solutions in the years to come.

100Mbps Fast Ethernet is a new standard specified by the IEEE 802.3 LAN committee. It is an extension of the 10Mbps Ethernet standard with the ability to transmit and receive data at 100Mbps, while maintaining the CSMA/CD Ethernet protocol. Since the 100Mbps Fast Ethernet is compatible with all other 10Mbps Ethernet environments, it provides a straightforward upgrade and takes advantage of the existing investment in hardware, software, and personnel training.

---

## Switching Technology

---

Another approach to pushing beyond the limits of Ethernet technology is the development of switching technology. A switch bridges Ethernet packets at the MAC address level of the Ethernet protocol transmitting among connected Ethernet or Fast Ethernet LAN segments.

Switching is a cost-effective way of increasing the total network capacity available to users on a local area network. A switch increases capacity and decreases network loading by dividing a local area network into different *segments*, which don't compete with each other for network transmission capacity.

The switch acts as a high-speed selective bridge between the individual segments. The switch, without interfering with any other segments, automatically forwards traffic that needs to go from one segment to another. By doing this the total network capacity is multiplied, while still maintaining the same network cabling and adapter cards.

For Fast Ethernet networks, a switch is an effective way of eliminating problems of chaining hubs beyond the "two-repeater limit." A switch can be used to split parts of the network into different collision domains, making it possible to expand your Fast Ethernet network beyond the 205-meter network diameter limit for 100BASE-TX networks. Switches supporting both traditional 10Mbps Ethernet and 100Mbps Fast Ethernet are also ideal for bridging between the existing 10Mbps networks and the new 100Mbps networks.



Switching LAN technology is a marked improvement over the previous generation of network bridges, which were characterized by higher latencies. Routers have also been used to segment local area networks, but the cost of a router, the setup and maintenance required make routers relatively impractical. Today switches are an ideal solution to most kinds of local area network congestion problems.

---

## Features

---

The Switches were designed for easy installation and high performance in an environment where traffic on the network and the number of user increase continuously.

The Switches with its rack size is specifically designed for middle to large workgroups. These Switches provide immediate access to a rapidly growing network through a wide range of user-reliable functions.

The Switches are ideal for deployment with multiple high-speed servers for shared bandwidth 10Mbps or 100Mbps workgroups. With the highest bandwidth 200Mbps (100Mbps full-duplex mode), any port can provide workstations with a congestion-free data pipe for simultaneous access to the server.

The Switches are expandable by cascading two or more switches together. As all ports support 200Mbps, the Switches can be cascaded from any port and to any number of switches.

The Switches are a perfect choice for site planning to

---

upgrade to Fast Ethernet in the future. Ethernet workgroups can connect to the Switches now, and change adapters and hubs anytime later without needing to change the Switches or reconfigure the network.

The Switches combine dynamic memory allocation with store-and-forward switching to ensure that the buffer is effectively allocated for each port, while controlling the data flow between the transmit and receive nodes to guarantee against all possible packet loss.

The Switches are an unmanaged 10/100 Fast Ethernet Switch offering solutions in accelerating small Ethernet workgroup bandwidth. Other key features are:

Auto-MDI function supports automatic MDI/MDIX crossover detection function gives true 'plug and play' capability without the need of confusing crossover cables or crossover ports.

Store and forward switching scheme capability. As the result of complete frame checking and error frame filtering, this scheme prevents error packages from transmitting among segments.

NWay Auto-negotiation for any port. This allows for auto-sensing of speed (10/100Mbps) thereby providing you with automatic and flexible solutions in your network connections.

Flow control for any port. This minimizes dropped packets by sending out collision signals when the port's receiving buffer is full. Note that flow control

is only available in half duplex mode.

Data forwarding rate per port is at wire-speed for 100Mbps speed.

Data forwarding rate per port is at wire-speed for 10Mbps speed.

Data filtering rate eliminates all error packets, runts, etc., per port at wire-speed for 100Mbps speed.

Data filtering rate eliminates all error packets, runts, etc., per port at wire-speed for 10Mbps speed.

Up to 8K active MAC address entry table with self-learning and table-aging for 16-port model, up to 8K active MAC address entry table with self-learning and table-aging for 24-port model.

512Kbyte RAM buffer per device for 16-port model, 2.5MB RAM buffer per device for 24-port model.

# ***UNPACKING AND INSTALLATION***

---

This chapter provides unpacking and setup information for the Switches.

---

## **Unpacking**

---

Open the shipping cartons of the Switch and carefully unpacks its contents. The carton should contain the following items:

- LevelOne FSW-1609/2409TFX 16/24-Port 10/100Mbps Fast Ethernet Switch
- One AC power cord, suitable for your area's electrical power connections
- Four rubber feet to be used for shock cushioning
- Screws and two mounting brackets
- This User Manual

If any item is found missing or damaged, please contact your local reseller for replacement.

---

## Installation

---

The site where you install the hub stack may greatly affect its performance. When installing, consider the following pointers:

Install the Switch in a fairly cool and dry place. See Appendix B for the acceptable temperature and humidity operating ranges.

Install the Switch in a site free from strong electromagnetic field generators (such as motors), vibration, dust, and direct exposure to sunlight.

Leave at least 10cm of space at the front and rear of the hub for ventilation.

Install the Switch on a sturdy, level surface that can support its weight, or in an EIA standard-size equipment rack. For information on rack installation, see the next section, *Rack Mounting*.

When installing the Switch on a level surface, attach the rubber feet to the bottom of each device. The rubber feet cushion the hub and protect the hub case from scratching.

---

## **100Base-FX Module Installation**

---

The installation procedure for each module is the same. Additional information about each module is provided below.

To install any of the modules: (Includes SC or ST type connectors)

1. Locate the module slot in the switch's rear panel.
2. Using a screwdriver, undo the two screws and remove the dust cover on the module slot.
3. Holding the module component-side up and connector-side in, gently slide the module along the guides and seat it in the internal connector.
4. Using a screwdriver, replace the two screws and tighten until snug.

We recommend that you retain the dust cover in case you need to remove the module for an extended period sometime in the future.

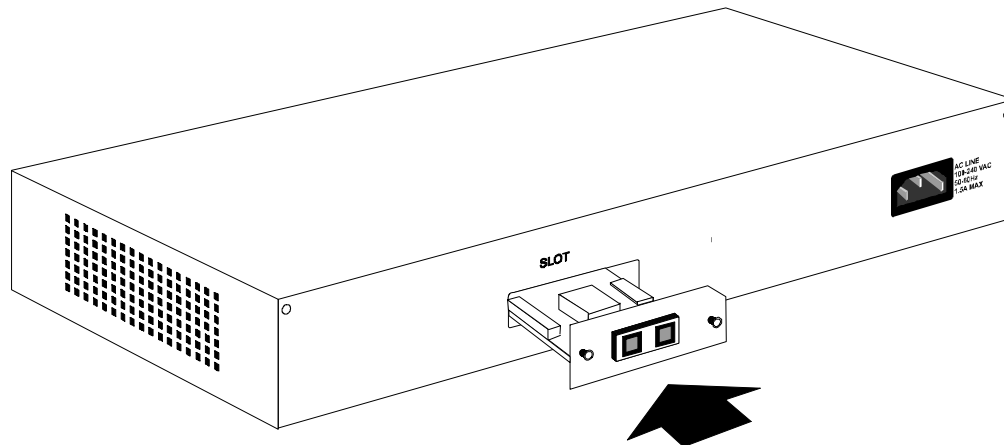

In FSW-1609/2409TFX, the last port (Port 16/24) and the 100BASE-FX port is really the same port. Do not use both Port 16/24 and the 100BASE-FX port at the same time.

---

## Rack Mounting

---

The switch can be mounted in an EIA standard-size, 19-inch rack, which can be placed in a wiring closet with other equipment. Attach the mounting brackets at the switch's front panel (one on each side), and secure them with the provided screws.

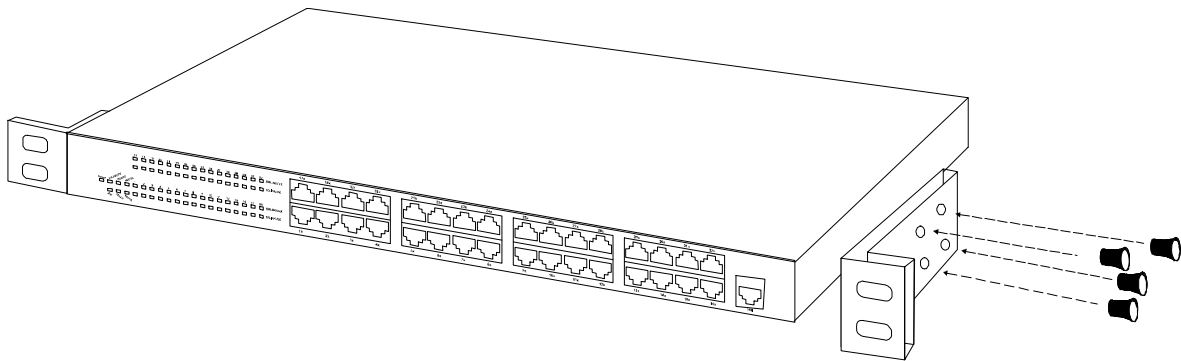

Then, use screws provided with the equipment rack to mount each switch in the rack.

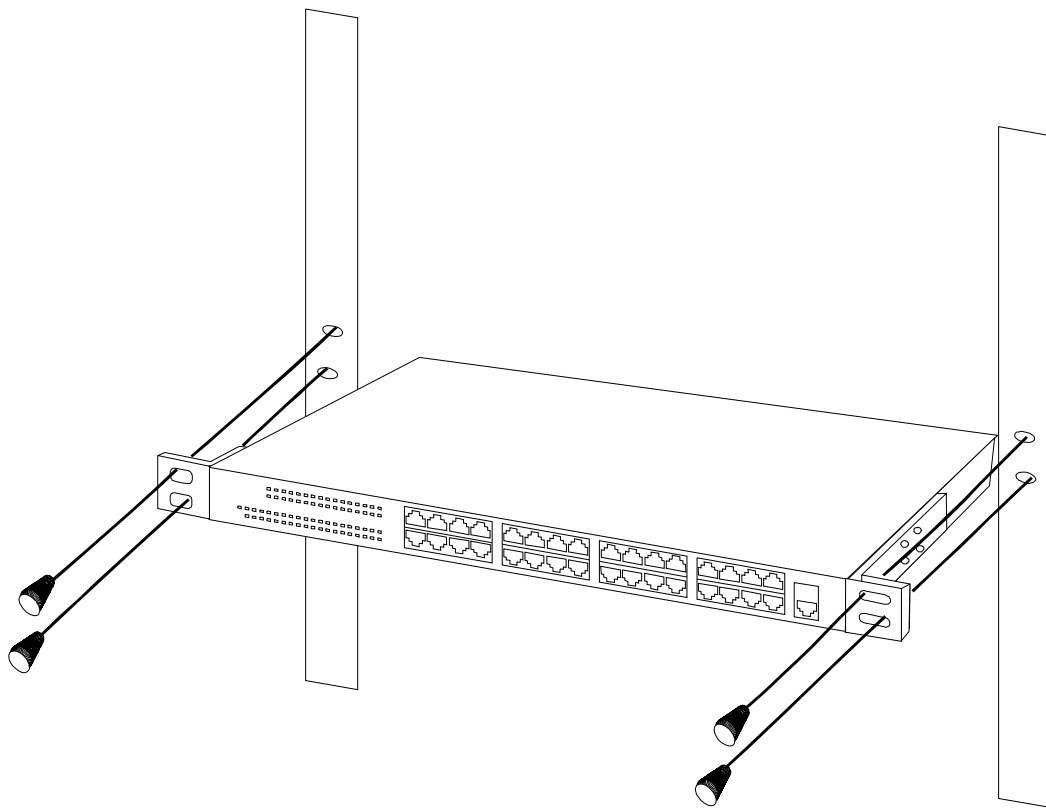



## Identifying External Components

This section identifies all the major external components of the switch. Both the front and rear panels are shown, followed by a description of each panel feature. The indicator panel is described in detail in the next chapter.

---

### Front Panel

---

The figure below shows the front panels of the switches.



**16-port 10/100M Fast Ethernet Switch**

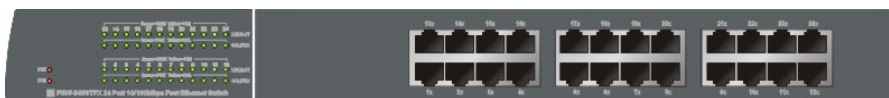

**24-port 10/100M Fast Ethernet Switch**

### LED Indicator Panel

Refer to the next chapter for detailed information about each of the switch's LED indicators.

- **Auto-MDI/MDIX Jacks:**

These jacks supports automatic MDI/MDIX crossover detection function gives true 'plug and play' capability without the need of confusing crossover cables or crossover ports.

With the Auto-MDI/MDIX function, you just need to plug-in the network cable to the hub directly and no need to care if the end node is NIC (Network Interface Card) or switches and hubs.

---

## Rear Panel

---



**LevelOne 16/24-Port 10/100Mbps Fast Ethernet Switch**

### Module Slots:

Used to install module options for 100BASE-FX connection.

### AC Power Connector:

For the power cord.

---

## LED Indicators

---

### Power Indicator (PWR)

This LED lights green when the switch is receiving current; if not, power is off.

### 100M Link/Activity, 10M Link/Activity (100M LINK/ACT (*green*), 10LINK/ACT (*yellow*))

This indicator light green when the port is connected to a 100Mbps Fast Ethernet station, if the indicator blinking green will be transmitting or received data on the 100Mbps network. Otherwise, if the indicator light amber when the port is connected to a 10Mbps Ethernet station, if the indicator blinking amber will be transmitting or received data on the 10Mbps network.

### 100BASE-FX Module Indicator (*green*)

The FX Link/Rx, indicate a good link to a module installed.

### Full/Half Duplex, 10/100M Collision ( 10/100M FDX (*green*), 10/100M COL (*blinking*))

This LED indicator lights green when a respective port is in full duplex (FDX) mode. Otherwise, it is OFF for half duplex (HDX) operations. It blinking green when collisions are occurring on the respective port.

# ***CONNECTING THE SWITCH***

---

This chapter describes how to connect the Switch to your Fast Ethernet network.

---

## **PC to Switch**

---

A PC can be connected to the Switch via a two-pair Category 3, 4, 5 UTP/STP straight cable. The PC (equipped with a RJ-45 10/100Mbps phone jack) should be connected to any of the 16 ports (1x - 16x) for the 16-Port model, 24 ports (1x - 24x) for the 24-Port model.

The LED indicators for PC connection dependent on the LAN card capabilities. If LED indicators are not light after making a proper connection, check the PC LAN card, the cable, the Switch conditions and connections.

The following are LED indicator possibilities for a PC to Switch connection:

1. The “100M LINK/ACT, 10M LINK/ACT” LED indicator light green for hookup to 100Mbps speed or light amber for hookup to 10Mbps speed.
2. The “10/100M FDX, 10/100M COL LED” indicator depends upon LAN card capabilities for full-duplex or half-duplex.

---

## Hub to Switch

---

A hub (10 or 100BASE-TX) can be connected to the Switch via a two-pair Category 3, 4, 5 UTP/STP cable. The connection is accomplished from the hub uplink (MDI-II) port to any port of the Switch (MDI-X) ports.

### *A. 10BASE-T Hub*

For a 10BASE-T hub, the Switch LED indicators should light up as the following:

“10/100M FDX, 10/100M COL” LED indicator is *OFF*.

“100M LINK/ACT, 10LINK/ACT” LED indicator is light amber.

### *B. 100BASE-TX Hub*

For a 100BASE-TX hub, the Switch LED indicators should light up as the following:

“10/100M FDX, 10/100M COL” LED indicator is *OFF*.

“100M LINK/ACT, 10M LINK/ACT” LED indicator is light green.

---

## Switch to Switch (other devices)

---

The Switch can be connected to another switch or other devices (routers, bridges, etc.) via a two-pair Category 3, 4, 5 UTP/STP straight or crossover cable.

### *A. Using straight cable*

When using straight cable, this is done from the uplink (MDI-II) port of other Switch to any of the 10Mbps or 100Mbps (AUTO MDI-X) port of FSW-1609/2409TFX.

### *B. Using crossover cable*

When using crossover cable, this is done from any (MDI-X) port of the Switch (Switch A) to any of the 10Mbps, 100Mbps (AUTO MDI-X) port of FSW-1609/2409TFX.

1. The “100M LINK/ACT, 10M LINK/ACT” LED indicator light green for hookup to 100Mbps speed or light amber for hookup to 10Mbps speed.
2. The “10/100M FDX, 10/100M COL” LED indicator depends upon LAN card capabilities for full-duplex or half-duplex.

---

## Port Speed & Duplex Mode

---

After plugging the selected cable to a specific port, the system uses auto-negotiation to determine the transmission mode for any new twisted-pair connection:

**If the attached device does not support auto-negotiation or has auto-negotiation disabled, an auto-sensing process is initiated to select the speed and set the duplex mode to half-duplex.**

# TECHNICAL SPECIFICATIONS

General	
Standards	IEEE 802.3 10Base-T Ethernet IEEE 802.3u 100 Base-TX Fast Ethernet ANSI/IEEE 802.3 NWay auto-negotiation
Protocol	CSMA/CD
Data Transfer Rate	Ethernet: 10Mbps (half duplex) 20Mbps (full duplex) Fast Ethernet: 100Mbps (half duplex) 200Mbps (full duplex)
Topology	Star
Network Cables	10BASE-T: 2-pair UTP Cat. 3,4,5 (100 m), EIA/TIA- 568 100-ohm STP (100 m) 100BASE-TX: 2-pair UTP Cat. 5 (100 m), EIA/TIA-568 100-ohm STP (100 m) 100BASE-FX: 62.5/125 micron multimode fiber optic (2km)
Number of Ports	16-port: 16 x 10/100Mbps NWay ports 24-port: 24 x 10/100Mbps NWay ports



## Physical and Environmental

AC inputs	100 to 240 VAC, 50 or 60 Hz internal universal power supply
Power Consumption	FSW-1609TFX 10 watts. (max.) FSW-2409TFX 20 watts. (max.)
Temperature	Operating: 0° ~ 50° C, Storage: -10° ~ 70° C
Humidity	Operating: 10% ~ 90%, Storage: 5% ~ 90%
Dimensions	440 x 200 x 44 mm (W x H x D)
EMI:	FCC Class A, CE Mark

## Performance

Transmission Method:	Store-and-forward
RAM Buffer:	16-port: 512K byte per device 24-port: 2.5M bytes per device
Filtering Address Table:	16-port: Up to 8K entries per device 24-port: Up to 8K entries per device
Packet Filtering/Forwarding Rate:	10Mbps Ethernet: 14,880/pps 100Mbps Fast Ethernet: 148,800/pps
MAC Address Learning:	Automatic update

## ***RJ-45 PIN SPECIFICATION***

---

When connecting your Level One 16/24-Port 10/100Mbps Fast Ethernet Switch to another switch, a bridge or a hub, a modified crossover cable is necessary. Please review these products for matching cable pin assignment.

The following diagram and tables show the standard RJ-45 receptacle/connector and their pin assignments for the switch-to-network adapter card connection, and the straight / crossover cable for the Switch-to-switch / hub / bridge connection.

<b>RJ-45 Connector pin assignment</b>	
<b>Contact</b>	<b>Media Direct Interface Signal</b>
1	TX + (transmit)
2	TX - (transmit)
3	Rx + (receive)
4	Not used
5	Not used
6	Rx - (receive)
7	Not used
8	Not used

**The standard cable, RJ-45 pin assignment**

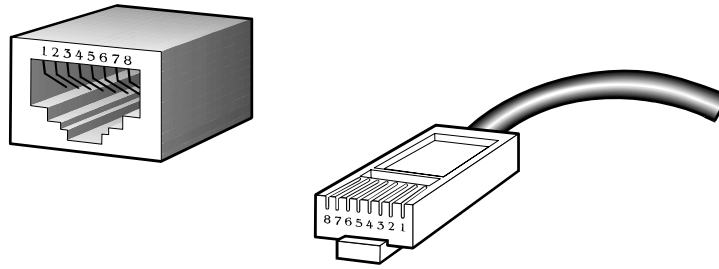

## The standard RJ-45 receptacle/connector

The following shows straight cable and crossover cable connection:

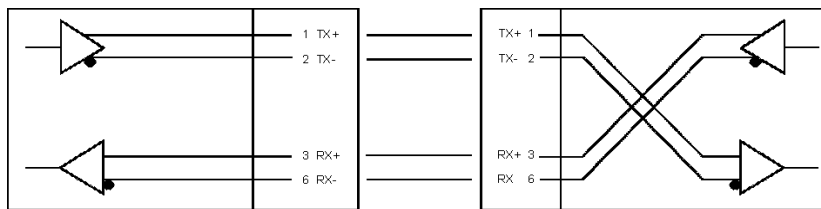

### Straight cable for Switch (uplink MDI-II port) to switch/Hub or other devices connection

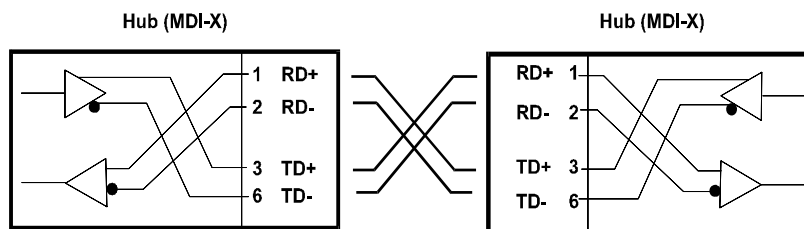

### Crossover cable for Switch (MDI-X port) to switch/hub or other network devices (MDI-X port) connection

## Free Manuals Download Website

<http://myh66.com>

<http://usermanuals.us>

<http://www.somanuals.com>

<http://www.4manuals.cc>

<http://www.manual-lib.com>

<http://www.404manual.com>

<http://www.luxmanual.com>

<http://aubethermostatmanual.com>

Golf course search by state

<http://golfingnear.com>

Email search by domain

<http://emailbydomain.com>

Auto manuals search

<http://auto.somanuals.com>

TV manuals search

<http://tv.somanuals.com>