



# DVD PLAYER

## OWNER'S MANUAL

MODEL : DNX190UH/DNX190MH



Before connecting, operating or adjusting this product,  
please read this instruction booklet carefully and completely.

FOR THE GUARANTEE TERMS & CONDITIONS,  
PLEASE REFER TO BACK COVER OF THIS MANUAL.



**CAUTION:** TO REDUCE THE RISK OF ELECTRIC SHOCK DO NOT REMOVE COVER (OR BACK) NO USER-SERVICEABLE PARTS INSIDE REFER SERVICING TO QUALIFIED SERVICE PERSONNEL.



This lightning flash with arrowhead symbol within an equilateral triangle is intended to alert the user to the presence of uninsulated dangerous voltage within the product's enclosure that may be of sufficient magnitude to constitute a risk of electric shock to persons.



The exclamation point within an equilateral triangle is intended to alert the user to the presence of important operating and maintenance (servicing) instructions in the literature accompanying the product.

**WARNING:** TO PREVENT FIRE OR ELECTRIC SHOCK HAZARD, DO NOT EXPOSE THIS PRODUCT TO RAIN OR MOISTURE.

**CAUTION:** Do not block any ventilation openings. Install in accordance with the manufacturer's instructions.

Slots and openings in the cabinet are provided for ventilation and to ensure reliable operation of the product and to protect it from over heating.

The openings should never be blocked by placing the product on a bed, sofa, rug or other similar surface. This product should not be placed in a built-in installation such as a bookcase or rack unless proper ventilation is provided or the manufacturer's instruction have been adhered to.

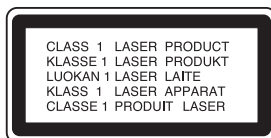

**CAUTION:** VISIBLE AND INVISIBLE LASER RADIATION WHEN OPEN AND INTERLOCKS DEFEATED.

**CAUTION:**

This product employs a Laser System. To ensure proper use of this product, please read this owner's manual carefully and retain it for future reference. Should the unit require maintenance, contact an authorized service center.

Use of controls, adjustments or the performance of procedures other than those specified herein may result in hazardous radiation exposure.

To prevent direct exposure to laser beam, do not try to open the enclosure. Visible laser radiation when open. DO NOT STARE INTO BEAM.

**CAUTION:** The apparatus should not be exposed to water (dripping or splashing) and no objects filled with liquids, such as vases, should be placed on the apparatus.

**CAUTION concerning the Power Cord**

**Most devices are recommended be placed on a dedicated circuit;**

That is, a single outlet circuit which powers only that electronic device and has no additional outlets or branch circuits. Check the specification page of this owner's manual to be certain.

Do not overload wall outlets. Overloaded wall outlets, loose or damaged wall outlets, extension cords, frayed power cords, or damaged or cracked wire insulation are dangerous. Any of these conditions could result in electric shock or fire. Periodically examine the cord of your appliance, and if its appearance indicates damage or deterioration, unplug it, discontinue use of the appliance, and have the cord replaced with an exact replacement part by an authorized servicer.

Protect the power cord from physical or mechanical abuse, such as being twisted, kinked, pinched, closed in a door, or walked upon. Pay particular attention to plugs, wall outlets, and the point where the cord exits the appliance.

To disconnect power from the mains, pull out the mains cord plug. When installing the product, ensure that the plug is easily accessible.

**POWER:** This unit operates on a mains supply of 200-240V, 50/60Hz.

**WIRING:** This unit is supplied with a BSI 1363 approved 13 amp mains plug, fused at 5 amp. When replacing the fuse always use a 5 amp BS 1362, BSI or ASTA approved type. Never use this plug with the fuse cover omitted. To obtain a replacement fuse cover contact your dealer. If the type of plug supplied is not suitable for the mains sockets in your home, then the plug should be removed and a suitable type fitted. Please refer to the wiring instructions below:

**WARNING:** A mains plug removed from the mains lead of this DVD player must be destroyed. A mains plug with bared wires is hazardous if inserted in a mains socket.

Do not connect either wire to the earth pin, marked with the letter E or with the earth symbol  $\perp$  or coloured green or green and yellow.

If any other plug is fitted, use a 5 amp fuse, either in the plug, or at the distribution board.

**IMPORTANT:** The wires in this mains lead are coloured in accordance with the following codes:

- **BLUE: NEUTRAL, BROWN: LIVE** - As the colours of the wires in the mains lead of this DVD player may not correspond with the coloured marking identifying the terminals in your plug, proceed as follows: The wire which is coloured blue must be connected to the terminal which is marked with the letter N or coloured black. The wire which is coloured brown must be connected to the terminal which is marked with the letter L or coloured red.

**CE** This product is manufactured to comply with the radio interference requirements of EEC DIRECTIVE 89/336/EEC, 93/68/EEC and 73/23/EEC.



**Disposal of your old appliance**

1. When this crossed-out wheeled bin symbol is attached to a product it means the product is covered by the European Directive 2002/96/EC.
2. All electrical and electronic products should be disposed of separately from the municipal waste stream via designated collection facilities appointed by the government or the local authorities.
3. The correct disposal of your old appliance will help prevent potential negative consequences for the environment and human health.
4. For more detailed information about disposal of your old appliance, please contact your city office, waste disposal service or the shop where you purchased the product.

# Contents

<b>Introduction</b> .....	<b>5-8</b>	<b>Operations</b> .....	<b>16-23</b>
<b>About the  Symbol Display</b> .....	<b>5</b>	<b>General Features</b> .....	<b>16</b>
<b>Symbol used in this Manual</b> .....	<b>5</b>	<b>Additional Features</b> .....	<b>17</b>
<b>Notes on Discs</b> .....	<b>5</b>	<b>DVD Audio Discs</b> .....	<b>18</b>
Handling Discs .....	5	Moving to another GROUP .....	18
Storing Discs .....	5	Viewing another PAGE .....	18
Cleaning Discs .....	5	<b>Playing an Memory Card</b> .....	<b>19</b>
<b>Types of Playable Discs</b> .....	<b>6</b>	<b>Playing an USB</b> .....	<b>19</b>
<b>Regional Code</b> .....	<b>6</b>	<b>Playing an Audio CD or MP3/WMA file</b> ....	<b>20</b>
<b>Front Panel</b> .....	<b>7</b>	<b>Programmed Playback</b> .....	<b>20</b>
<b>Remote Control</b> .....	<b>8</b>	Repeat Programmed Tracks .....	20
Remote Control Operation .....	8	Erasing a Track from Program List .....	20
Remote Control Battery Installation .....	8	Erasing the Complete Program List .....	20
<b>Installation and Setup</b> .....	<b>9-15</b>	<b>Viewing a JPEG file</b> .....	<b>21</b>
<b>Setting up the Player</b> .....	<b>9</b>	Slide Show .....	21
<b>DVD Player Connections</b> .....	<b>9</b>	Still Picture .....	21
Video and Audio Connections to Your TV ..	9	Moving to another File .....	21
Resolution setting .....	9	Zoom .....	21
HDMI connection .....	10	To rotate picture .....	21
<b>Audio Connection to Optional Equipment</b> ..	<b>11</b>	To listen to MP3 music while watching	21
<b>Displaying Disc Information on-screen</b> ....	<b>12</b>	picture .....	21
<b>Initial Settings</b> .....	<b>12</b>	<b>Playing a DivX Movie file</b> .....	<b>22</b>
General Operation .....	12	<b>Controlling other TVs with the</b>	
LANGUAGE .....	13	<b>remote control</b> .....	<b>23</b>
• Menu Language .....	13	<b>Maintenance and Service</b> .....	<b>23</b>
• Disc Audio / Subtitle / Menu .....	13		
DISPLAY .....	13		
• TV Aspect .....	13		
• Display Mode .....	13		
• TV Output Select .....	13		
AUDIO .....	14		
• Dolby Digital / DTS / MPEG .....	14		
• Sample Freq. (Frequency) .....	14		
• Dynamic Range Control (DRC) .....	14		
• Vocal .....	14		
LOCK (Parental Control) .....	14		
• Rating .....	14		
• Password .....	14		
• Area Code .....	15		
OTHERS .....	15		
• PBC .....	15		
• Auto Play .....	15		
• B.L.E. (Black Level Expansion) .....	15		
• DivX(R) VOD .....	15		
		<b>Reference</b> .....	<b>24-25</b>
		Language Codes .....	24
		Area Codes .....	24
		Troubleshooting .....	25
		Specifications .....	25

# Introduction

To ensure proper use of this product, please read this owner's manual carefully and retain for future reference.

This manual provides information on the operation and maintenance of your DVD player. Should the unit require service, contact an authorized service location.

## About the Symbol Display

"" may appear on your TV display during operation and indicates that the function explained in this owner's manual is not available on that specific DVD video disc.

## Symbol Used in this Manual









### Note:

Indicates special notes and operating features.

### Tip:

Indicates tips and hints for making the task easier.

A section whose title has one of the following symbols is applicable only to the disc represented by the symbol.

-  All discs and file listed below
-  DVD and finalized DVD±R/RW
-  DVD Audio discs
-  Video CDs
-  Audio CDs
-  MP3 files
-  WMA files
-  DivX files
-  Memory Card

## Notes on Discs

### Handling Discs

Do not touch the playback side of the disc. Hold the disc by the edges so that fingerprints do not get on the surface. Never stick paper or tape on the disc.



### Storing Discs

After playing, store the disc in its case. Do not expose the disc to direct sunlight or sources of heat and never leave it in a parked car exposed to direct sunlight.

### Cleaning Discs

Fingerprints and dust on the disc can cause poor picture quality and sound distortion. Before playing, clean the disc with a clean cloth. Wipe the disc from the center out.

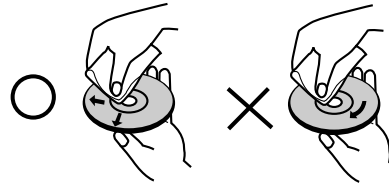

Do not use strong solvents such as alcohol, benzine, thinner, commercially available cleaners, or anti-static spray intended for older vinyl records.

## Types of Playable Discs

	DVD (8 cm / 12 cm disc)
	DVD audio discs (8 cm / 12 cm disc)
	Video CD (VCD/SVCD) (8 cm / 12 cm disc)
	Audio CD (8 cm / 12 cm disc)

In addition, this unit plays DVD±R/RW and CD-R/RW Memory Card, USB that contains audio titles, DivX, MP3, WMA, and/or JPEG files.

### Notes:

- Depending on the conditions of the recording equipment or the CD-R/RW (or DVD±R/RW) disc itself, some CD-R/RW (or DVD±R/RW) discs cannot be played on the unit.
- Do not use irregularly shaped CDs (e.g., heart-shaped or octagonal) since they may result in malfunctions.
- This DVD player requires discs and recordings to meet certain technical standards in order to achieve optimal playback quality. Pre-recorded DVDs are automatically set to these standards. There are many different types of recordable disc formats (including CD-R containing MP3 or WMA files) and these require certain pre-existing conditions (see above) to ensure compatible playback.

**Customers should note that permission is required in order to download MP3 / WMA files and music from the Internet. Our company has no right to grant such permission. Permission should always be sought from the copyright owner.**

## Regional Code

This unit has a regional code printed on the rear of the unit. This unit can play only DVD discs labelled same as the rear of the unit or "ALL".

### Notes on Regional Codes

- Most DVD discs have a globe with one or more numbers in it clearly visible on the cover. This number must match your unit's regional code or the disc cannot play.
- If you try to play a DVD with a different regional code from your player, the message "Check Regional Code" appears on the TV screen.

### Notes on Copyrights:

It is forbidden by law to copy, broadcast, show, broadcast via cable, play in public, or rent copyrighted material without permission. This product features the copy protection function developed by Macrovision. Copy protection signals are recorded on some discs. When recording and playing the pictures of these discs picture noise will appear. This product incorporates copyright protection technology that is protected by method claims of certain U.S. patents and other intellectual property rights owned by Macrovision Corporation and other rights owners. Use of this copyright protection technology must be authorized by Macrovision Corporation, and is intended for home and other limited viewing uses only unless otherwise authorized by Macrovision Corporation. Reverse engineering or disassembly is prohibited.

CONSUMERS SHOULD NOTE THAT NOT ALL HIGH DEFINITION TELEVISION SETS ARE FULLY COMPATIBLE WITH THIS PRODUCT AND MAY CAUSE ARTIFACTS TO BE DISPLAYED IN THE PICTURE. IN CASE OF 525 OR 625 PROGRESSIVE SCAN PICTURE PROBLEMS, IT IS RECOMMENDED THAT THE USER SWITCH THE CONNECTION TO THE 'STANDARD DEFINITION' OUTPUT. IF THERE ARE QUESTIONS REGARDING OUR TV SET COMPATIBILITY WITH THIS MODEL 525p AND 625p DVD PLAYER, PLEASE CONTACT OUR CUSTOMER SERVICE CENTER.

## Front Panel

### DNX190UH

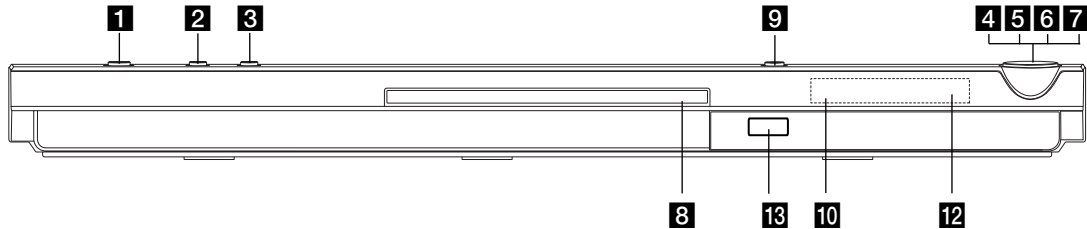

### DNX190MH

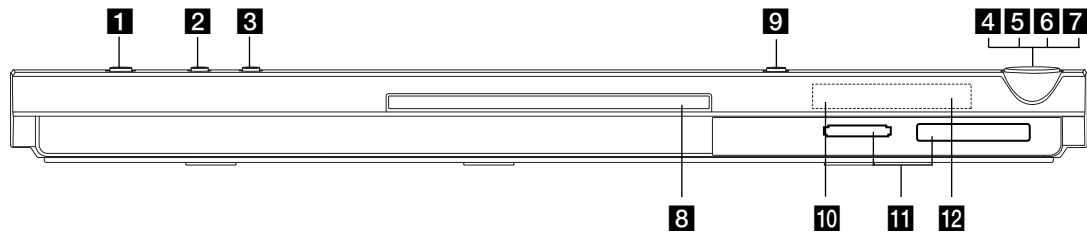

- |  |  |
|--|--|
| <p><b>1 POWER</b><br/>Switches the unit ON and OFF.</p> <p><b>2 RES.</b><br/>You can change the resolution depending on your TV.</p> <p><b>3 MEMORY</b><br/>Accesses the menu for memory card or USB.</p> <p><b>4 ► (PLAY)</b><br/>Starts playback.</p> <p><b>5 ■ (STOP)</b><br/>Stops playback.</p> <p><b>6 SKIP (◀◀)</b><br/>Returns to beginning of current chapter or track or go to previous chapter or track.</p> <p><b>7 SKIP (▶▶)</b><br/>Go to next chapter or track.</p> | <p><b>8 Disc Tray</b><br/>Insert a disc here.</p> <p><b>9 ▲ (OPEN / CLOSE)</b><br/>Opens or closes the disc tray.</p> <p><b>10 Display window</b><br/>Shows the current status of the unit.</p> <p><b>11 MEMORY CARD Slot</b><br/>Insert a memory card.</p> <p><b>12 Remote Sensor</b><br/>Point the remote control here.</p> <p><b>13 USB</b><br/>Insert a USB.</p> |
|--|--|

## Remote Control

**POWER**  
Switches DVD Player ON and OFF.

**OPEN/CLOSE (▲)**  
Opens and closes the disc tray.

**0-9 numerical buttons**  
Selects numbered items in a menu.

**CLEAR**  
Removes a track number on the Program List or a mark on the Marker Search menu.

**TV Control Buttons**  
POWER: Turns the TV on or off.  
AV: Selects the TV's source.  
PR/CH +/-: Selects TV's channel.  
VOL +/-: Adjusts TV's volume.

**DVD MENU**  
Accesses menu on a DVD disc.

**TITLE**  
Displays title menu, if available.

**◀ / ▶ / ▲ / ▼ (left/right/up/down)**  
Selects an item in the menu.

**DISPLAY**  
Accesses On-Screen Display.

**RETURN (↶)**  
Displays the video CD with PBC.

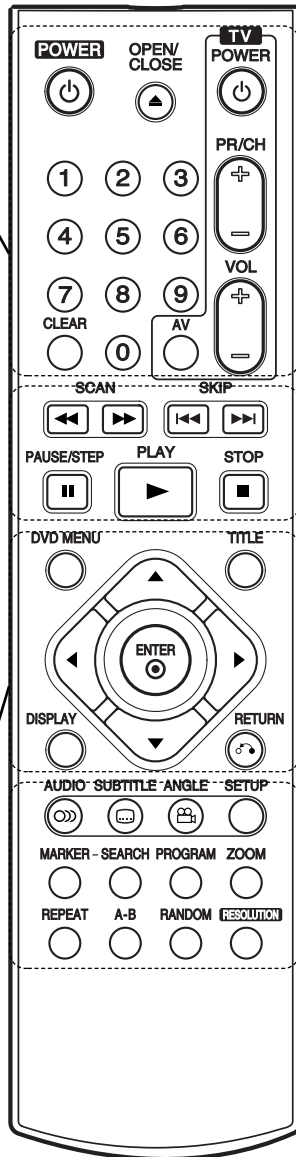

**SCAN (◀◀ / ▶▶)**  
Search backward or forward.

**SKIP (◀◀◀ / ▶▶▶)**  
Go to next chapter or track. Returns to beginning of current chapter or track or go to previous chapter or track.

**PAUSE / STEP (||)**  
Pauses playback temporarily/ press repeatedly for frame-by-frame playback.

**PLAY (▶)**  
Starts playback.

**STOP (■)**  
Stops playback.

**AUDIO**  
Selects an audio language or an audio channel.

**SUBTITLE**  
Selects a subtitle language.

**ANGLE**  
Selects a DVD camera angle, if available.

**SETUP**  
Accesses or removes the Setup menu.

**MARKER**  
Marks any point during playback.

**SEARCH**  
Displays MARKER SEARCH menu.

**PROGRAM**  
Enter to program edit mode.

**ZOOM**  
Enlarges video image.

**REPEAT**  
Repeat chapter, track, title, all.

**A-B**  
Repeat sequence from point A to point B.

**RANDOM**  
Plays tracks in random order.

**RESOLUTION**  
You can change the resolution depending on your TV.

### Remote Control Operation

Point the remote control at the remote sensor and press the buttons.

### Caution:

Do not mix old and new batteries and never mix different types of batteries such as standard, alkaline, etc.

### Remote Control Battery installation

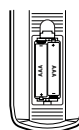

Detach the battery cover on the rear of the remote control, and insert two batteries (size AAA) with ⊕ and ⊖ aligned correctly.



# Installation and Setup

## Setting up the Player

The picture and sound of a nearby TV, VCR, or radio may be distorted during playback. If this occurs, position the player away from the TV, VCR, or radio, or turn off the unit after removing the disc.

## DVD Player Connections

Depending on your TV and other equipment there are various ways you can connect the player. Please refer to the manuals of your TV, stereo system or other devices as necessary for additional connection information.

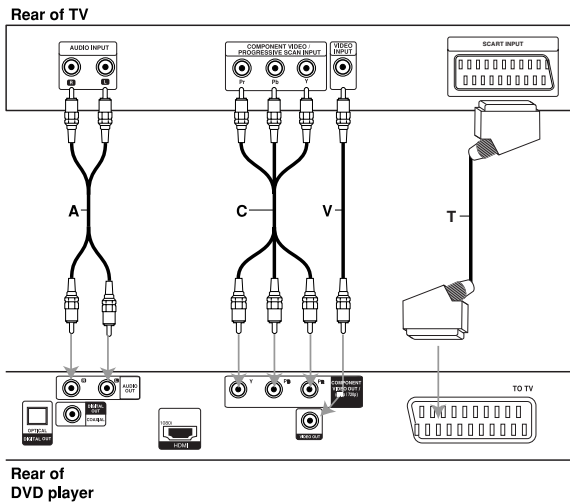

**Caution:** You must set the TV Output Select option on the setup menu to use COMPONENT VIDEO OUT/ (576p/720p) jack or SCART's RGB signal. (Refer to page 13.)

## Video and Audio Connections to Your TV

Make sure the DVD player is connected directly to the TV and not to a VCR, otherwise the DVD image could be distorted by the copy protection system.

**SCART connection** – Connect the TO TV scart jack on the DVD player to the corresponding in jacks on the TV using the scart cable (**T**).

**Video** – Connect the VIDEO OUT jack on the DVD player to the video in jack on the TV using the video cable (**V**)

**Audio** – Connect the left and right AUDIO OUT jacks of the DVD Player to the audio left and right IN jacks on the TV (**A**) using the audio cables.

Do not connect the DVD Player's AUDIO OUT jack to the phone in jack (record deck) of your audio system.

**Component Video** – Connect the COMPONENT VIDEO OUT/ (576p/720p) jacks on the DVD Player to the corresponding in jacks on the TV using an Y Pb Pr cable (**C**).

### Progressive Scan

- If your television is a high-definition or “digital ready” television, you may take advantage of the unit's progressive scan output for the highest video resolution possible.
- Progressive scan does not work with the analog video connections (yellow VIDEO OUT jack).
- The 720p and 576p(480p) resolutions are the progressive scan applied resolution.

## Resolution setting

1. Before you set the resolution, this unit must be in stop mode. Press STOP to stop playback.
2. Press RESOLUTION once. The current resolution setting will be appears in the display window.
3. Press RESOLUTION repeatedly to change the resolution you want.

The available resolution according to the connections are as shown below.

OUTPUT CONNECTION	Available Resolution	
	PAL	NTSC
HDMI VIDEO OUT	1920 x 1080i 1280 x 720p 720 x 576p	1920 x 1080i 1280 x 720p 720 x 480p
COMPONENT VIDEO OUT	1280 x 720p 720 x 576p 720 x 576i	1920 x 1080i 1280 x 720p 720 x 480p 720 x 480i
VIDEO OUT	720 x 576i	720 x 480i
SCART	720 x 576i	720 x 480i

### Notes:

- For Video and SCART connections, resolution must be set to 576i(480i) or 576p(480p) by pressing RESOLUTION button, however Video OUT and SCART is always at 576i(480i) standard resolution.
- If your TV does not accept your resolution setting, abnormal picture appears on the screen. Please read TV's owner's manual then set the resolution that your TV can accept.
- For 720p and 1080i resolution on the component video out, only non-copy protected discs can be played back. If the disc is copy protected, it will be displayed at the 576p(480p) resolution without HDMI cable connection. With HDMI cable connection, the picture may not be displayed properly.

## HDMI connection

If you have a HDMI TV or monitor, you can connect it to this player using a HDMI cable.

1. Set the TV's source to HDMI (refer to TV's Owner's manual).
2. Connect the HDMI OUT jack on the unit to the HDMI jack on a HDMI compatible TV or monitor (H).
3. Press RESOLUTION repeatedly to select the desired resolution.

### Notes :

- Both PCM and Bitstream Audio out is available, when the sample frequency is set to 48kHz in HDMI connection.
- If Audio setup is set to bitstream and your TV does not support Bitstream Audio out in HDMI connection, audio sound may not output or distorted.
- When the no sound or noisy sound are output with HDMI connection, set the Audio option [Dolby Digital, DTS or MPEG] in the SETUP menu to PCM or Off.
- The arrow on the cable connector body should face up for correct alignment with the connector on the player.

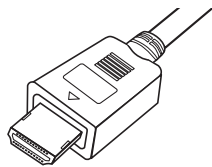

- If there is noise or lines on the screen, please check the HDMI cable.
- Not all HDCP-compatible DVI devices will work with this unit.
- If your HDMI TV does not support HDCP, the blue screen appears on the screen.
- If an abnormal picture appears on the TV screen, turn off the unit and then turn the unit on again.

### Tips:

- When you use HDMI connection, you can change the resolution (576i(480i), 576p(480p), 720p, 1080i) for the HDMI output.
- The HDMI will out at 576p(480p) resolution, even if you set the resolution to 576i(480i) on the HDMI connection.

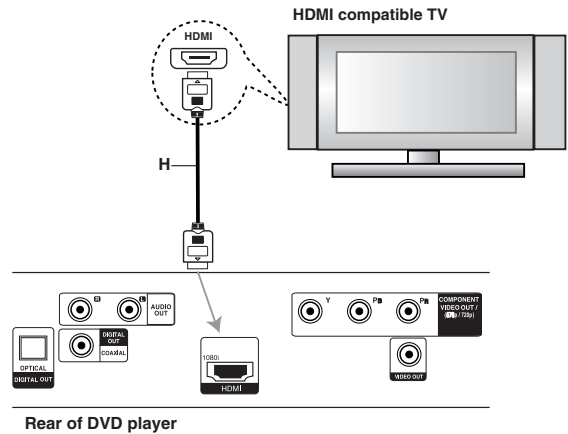

### About HDMI

HDMI (High Definition Multimedia Interface) supports both video and audio on a single digital connection for use with DVD Players, Set-Top Boxes, and other AV devices.

HDMI was developed to provide the technologies of HDCP (High-bandwidth Digital Content Protection). HDCP is used to protect digital content transmitted and received.

HDMI has the capability to support standard, enhanced, or high-definition video plus standard to multi-channel surround-sound audio, HDMI features include uncompressed digital video, a bandwidth of up to 5 gigabytes per second, one connector (instead of several cables and connectors), and communication between the AV source and AV devices such as DTVs.

*HDMI, the HDMI logo and High-Definition Multimedia Interface are trademarks or registered trademarks of HDMI licensing LLC.*

## Audio Connection to Optional Equipment

Connect the DVD player to your optional equipment for audio output.

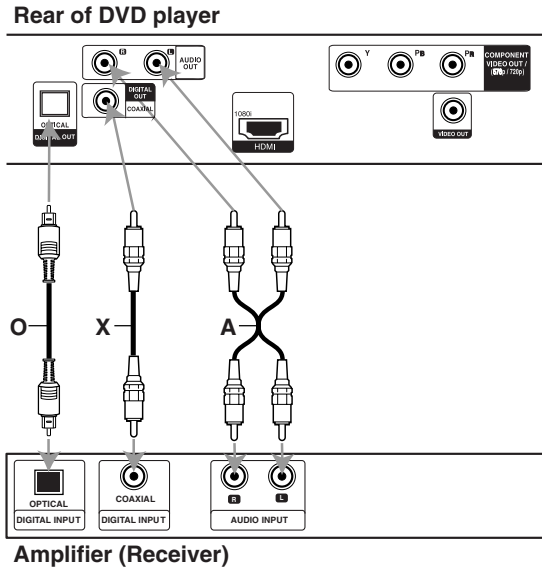

Manufactured under license from Dolby Laboratories. "Dolby", "Pro Logic", and the double-D symbol are trademarks of Dolby Laboratories.

DTS and DTS Digital Out are trademarks of Digital Theater Systems, Inc.

**Amplifier equipped with 2-channel analog stereo or Dolby Pro Logic II / Pro Logic:** Connect the left and right AUDIO OUT jacks on the DVD player to the audio left and right IN jacks on your amplifier, receiver, or stereo system, using the audio cables (A).

**Amplifier equipped with 2-channel digital stereo (PCM) or audio / video receiver equipped with a multi-channel decoder (Dolby Digital™, MPEG 2, or DTS):** Connect one of the DVD Player's DIGITAL AUDIO OUT jacks (OPTICAL O or COAXIAL X) to the corresponding in jack on your amplifier. Use an optional digital (OPTICAL O or COAXIAL X) audio cable.

### Digital Multi-channel sound

A digital multi-channel connection provides the best sound quality. For this you need a multi-channel audio / video receiver that supports one or more of the audio formats supported by your DVD player such as MPEG 2, Dolby Digital and DTS. Check the receiver manual and the logos on the front of the receiver.

### Notes:

- If the audio format of the digital output does not match the capabilities of your receiver, the receiver produces a strong, distorted sound or no sound at all.
- Six Channel Digital Surround Sound via a digital connection can only be obtained if your receiver is equipped with a Digital Multi-channel decoder.

## Displaying Disc Information on-screen

You can display various information about the disc loaded on-screen.

1. Press DISPLAY to show various playback information.  
The items displayed differ depending on the disc type or playing status.



2. You can select an item by pressing ▲ / ▼ and change or select the setting by pressing ◀ / ▶.
  - Title (Track) – Current title (or track) number/total number of titles (or tracks).
  - Chapter – Current chapter number/total number of chapters.
  - Time – Elapsed playing time.
  - Audio – Selected audio language or channel.
  - Subtitle – Selected subtitle.
  - Angle – Selected angle/total number of angles.
  - Sound – Selected sound mode.

### Note:

If no button is pressed for a few seconds, the on-screen display disappears.

## Initial Settings

By using the Setup menu, you can make various adjustments to items such as picture and sound. You can also set a language for the subtitles and the Setup menu, among other things. For details on each Setup menu item, see pages 13 to 15.

### To display and exit the Menu:

Press SETUP to display the menu. A second press of SETUP will take you back to initial screen.

### To go to the next level:

Press ▶ on the remote control.

### To go back to the previous level:

Press ◀ on the remote control.

## General Operation

1. Press SETUP. The Setup menu appears.

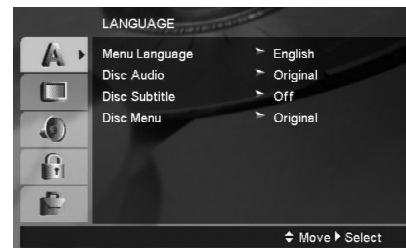

2. Use ▲ / ▼ to select the desired option then press ▶ to move to the second level. The screen shows the current setting for the selected item, as well as alternate setting(s).
3. Use ▲ / ▼ to select the second desired option then press ▶ to move to the third level.
4. Use ▲ / ▼ to select the desired setting then press ENTER to confirm your selection. Some items require additional steps.
5. Press SETUP or PLAY to exit the Setup menu.

## LANGUAGE



### Menu Language

Select a language for the Setup menu and on-screen display.

### Disc Audio / Subtitle / Menu

Select the language you prefer for the audio track (disc audio), subtitles, and the disc menu.

**Original** – Refers to the original language in which the disc was recorded.

**Other** – To select another language, press number buttons then ENTER to enter the corresponding 4-digit number according to the language code list on page 24. If you enter the wrong language code, press CLEAR.

**Off (for Disc Subtitle)** – Turn off Subtitle.

## DISPLAY



### TV Aspect

**4:3** – Select when a standard 4:3 TV is connected.

**16:9** – Select when a 16:9 wide TV is connected.

### Display Mode

Display Mode setting works only when the TV Aspect mode is set to "4:3".

**Letterbox** – Displays a wide picture with bands on the upper and lower portions of the screen.

**Panscan** – Automatically displays the wide picture on the entire screen and cuts off the portions that do not fit.

### TV Output Select

Set the player's TV Output Select options according to the TV connection type.

**YPbPr** – When your TV is connected with the COMPONENT VIDEO OUT/ (576p/720p) jacks on the DVD player.

**RGB** – When your TV is connected with the SCART (RGB signal) jack.

## AUDIO

Each DVD disc has a variety of audio output options. Set the player's AUDIO options according to the type of audio system you use.

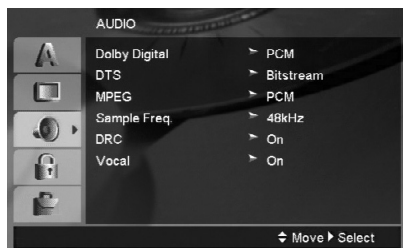

### Dolby Digital / DTS / MPEG

**Bitstream** – Select “Bitstream” if you connect this unit's DIGITAL OUT jack to an amplifier or other equipment with a Dolby Digital, DTS or MPEG decoder.

**PCM (for Dolby Digital / MPEG)** – Select when connected to a two-channel digital stereo amplifier. DVDs encoded in Dolby Digital or MPEG will be automatically downmixed to two-channel PCM audio.

**Off (for DTS):** If you select “Off”, the DTS signal is not output through the DIGITAL OUT jack.

### Sample Freq. (Frequency)

If your receiver or amplifier is NOT capable of handling 96 kHz signals, select 48 kHz. When this choice is made, this unit automatically converts any 96 kHz signals to 48 kHz so your system can decode them.

If your receiver or amplifier is capable of handling 96 kHz signals, select 96 kHz.

Check the documentation for your amplifier to verify its capabilities.

### Dynamic Range Control (DRC)

With the DVD format, you can hear a program's soundtrack in the most accurate and realistic presentation possible. However, you may wish to compress the dynamic range of the audio output (the difference between the loudest sounds and the quietest ones). This allows you to listen to a movie at a lower volume without losing clarity of sound. Set DRC to On for this effect.

### Vocal

Set to On only when a multi-channel karaoke DVD is playing. The karaoke channels on the disc mix into normal stereo sound.

## LOCK (Parental Control)

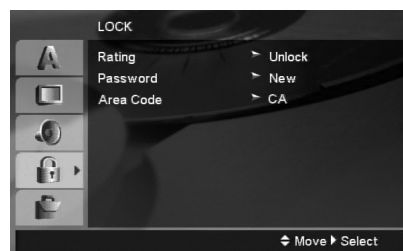

### Rating

Blocks playback of rated DVDs based on their content. Not all discs are rated.

1. Select “Rating” on the LOCK menu then press ►.
2. To access the LOCK options, you must input the password you have created. If you have not yet entered password, you are prompted to do so. Input a password and press ENTER. Enter it again and press ENTER to verify. If you make a mistake before pressing ENTER, press CLEAR.
3. Select a rating from 1 to 8 using the ▲ / ▼ buttons.

**Rating 1-8:** Rating one (1) has the most restrictions and rating eight (8) is the least restrictive.

**Unlock:** If you select unlock, parental control is not active and the disc plays in full.

4. Press ENTER to confirm your rating selection, then press SETUP to exit the menu.

### Password

You can enter or change password.

1. Select Password on the LOCK menu then press ►.
2. Follow step 2 as shown above (Rating). To change the password, press ENTER when the “Change” option is highlighted. Input a password and press ENTER. Enter it again and press ENTER to verify.
3. Press SETUP to exit the menu.

### **If you forget your password**

If you forget your password, you can clear it using the following steps:

1. Press SETUP to display the Setup menu.
2. Input the 6-digit number “210499” and press ENTER. The password is cleared.

### Area Code

Enter the code of the area whose standards were used to rate the DVD video disc, based on the list on page 24.

1. Select "Area Code" on the LOCK menu then press ►.
2. Follow step 2 as shown previous page (Rating).
3. Select the first character using ▲ / ▼ buttons.
4. Press ► and select the second character using ▲ / ▼ buttons.
5. Press ENTER to confirm your Area code selection.

### OTHERS

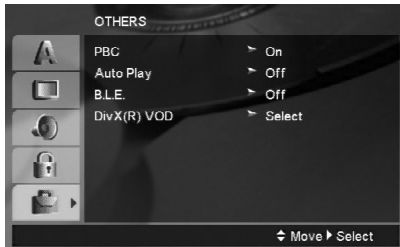

### PBC

Set Playback Control (PBC) to On or Off.

**On:** Video CDs with PBC are played according to the PBC.

**Off:** Video CDs with PBC are played the same way as Audio CDs.

### Auto Play

You can set up the unit so a DVD disc automatically starts playing whenever the DVD is inserted. If Auto Play mode is set to On, this unit will search for title that has the longest playback time and then play back the title automatically.

#### **Note:**

The Auto Play function may not work for some DVDs.

### B.L.E. (Black Level Expansion)

To select the black level of playback pictures. Set your preference and monitor's ability.

**On:** Expanded grey scale. (0 IRE cut off)

**Off:** Standard grey scale. (7.5 IRE cut off)

#### **Note:**

The B.L.E. function works NTSC system only.

### DivX(R) VOD

We provide you the DivX® VOD (Video On Demand) registration code that allows you to rent and purchase videos using the DivX® VOD service. For more information, visit [www.divx.com/vod](http://www.divx.com/vod).





















1. Select "DivX(R) VOD" option then press ►.
2. Press ENTER while "Select" is selected and the registration code will appear.  
Use the registration code to purchase or rent the videos from DivX® VOD service at [www.divx.com/vod](http://www.divx.com/vod). Follow the instructions and download the video onto a disc for playback on this unit.
3. Press ENTER to exit.

#### **Note:**

All the downloaded videos from DivX® VOD can only be played back on this unit.

# Operations

## General features

Buttons	Operations	Discs
 (OPEN / CLOSE)	Opens or closes the disc tray.	<b>ALL</b>
 (PAUSE)	During playback, press  to pause playback. Press  repeatedly to play Frame-by-Frame.	<b>ALL</b> <b>DVD-V</b> <b>DVD-A</b> <b>VCD</b> <b>DivX</b>
SKIP (  /  )	During playback, press SKIP (  or  ) to go to the next chapter/track or to return to the beginning of the current chapter/track. Press SKIP  twice briefly to step back to the previous chapter/track.	<b>ALL</b>
SCAN (  /  )	During playback, press SCAN (  or  ) repeatedly to select the required scan speed. DVD, DivX disc; 4 steps Video CD, MP3, Audio CD ; 3 steps While the playback is paused, press SCAN  repeatedly to play in slow motion (4 steps, forward only).	<b>DVD-V</b> <b>VCD</b> <b>DivX</b> <b>ACD</b> <b>MP3</b> <b>DVD-V</b> <b>VCD</b> <b>DivX</b>
REPEAT	During playback, press REPEAT repeatedly to select a desired repeat mode. DVD Video discs: Chapter/Title/Off Video CD, Audio CD, DivX/MP3/WMA discs: Track/All/Off	<b>ALL</b>
A-B	During playback, each press of A-B button to select point A and point B and repeats a sequence from point A (Starting point) to point B (End point).	<b>DVD-V</b> <b>VCD</b> <b>DivX</b> <b>ACD</b>
ZOOM	During playback or pause mode, press ZOOM to enlarge the video image (3 steps). You can move through the zoomed picture using     buttons. Press CLEAR to exit.	<b>DVD-V</b> <b>VCD</b> <b>DivX</b>
RANDOM	During playback or in stop mode, press RANDOM for random playback.	<b>ACD</b> <b>MP3</b> <b>WMA</b>
TITLE	If the current DVD title has a menu, the title menu appears on the screen. Otherwise, the disc menu may appear.	<b>DVD-V</b> <b>DVD-A</b>
DVD MENU	The disc menu appears on the screen.	<b>DVD-V</b> <b>DVD-A</b>
 (ANGLE)	During playback of DVD disc contains scenes recorded different camera angles, press ANGLE repeatedly to select a desired angle.	<b>DVD-V</b> <b>DVD-A</b>
 (SUBTITLE)	During playback, press SUBTITLE repeatedly to select a desired subtitle language.	<b>DVD-V</b> <b>DivX</b>
 (AUDIO)	During playback, press AUDIO repeatedly to hear a different audio language or audio track.	<b>DVD-V</b> <b>DVD-A</b> <b>DivX</b> <b>VCD</b> <b>ACD</b>



### Notes on general features:

- On a Video CD with PBC, you must set PBC to Off on the setup menu to use the repeat function (See "PBC" on page 15).
- If you press SKIP (▶▶) once during Repeat Chapter (Track) playback, the repeat playback cancels.
- Zoom may not work on some DVDs.
- When you are playing a DVD disc contains scenes recorded different camera angles, the angle indicator will blink on the TV screen during scenes recorded at different angles as an indication that angle switching is possible.
- The A-B repeat function is available only in the current track.

## Additional features

### 3D Surround

To produce a 3D surround effect that simulates multi-channel audio from two stereo speakers (instead of the five+ speakers normally required for multi-channel audio from a home theater system).

**DVD-V VCD DivX**

1. Press DISPLAY during playback.
2. Use ▲ or ▼ to select the sound option. The sound option will be highlighted.
3. Use ◀ or ▶ to select "3D SUR". To turn off the 3D Surround effect, select "Normal".

**ACD**

1. Press AUDIO during playback. "3D SUR." appears on the menu screen.
2. To return to normal playback, press AUDIO repeatedly until "3D SUR." disappears from the menu screen.

### Time Search **DVD-V VCD DivX**

To start playing at any chosen time on the disc:

1. Press DISPLAY during playback.
2. Press ▲ / ▼ to select the time clock icon and "--:--:--" appears.
3. Input the required start time in hours, minutes, and seconds from left to right. If you enter the wrong numbers, press CLEAR to remove the numbers you entered. Then input the correct numbers.
4. Press ENTER to confirm. Playback starts from the selected time.

### Marker Search **DVD-V VCD DivX**

#### To enter a Marker

You can start playback from up to nine memorized points. To enter a marker, press MARKER at the desired point on the disc. The Marker icon appears on the TV screen briefly. Repeat to enter up to nine markers.

#### To Recall or Clear a Marked Scene

1. During disc playback, press SEARCH. The marker search menu appears on the screen.
2. Within 10 seconds, press ◀ / ▶ to select a marker number that you want to recall or clear.
3. Press ENTER and playback starts from the marked scene. Or, Press CLEAR and the marker number is erased from the list.
4. You can play any marker by inputting its number on the marker search menu.

### Last Scene Memory **DVD-V ACD VCD1.1**

This player memorizes last scene from the last disc that is viewed. The last scene remains in memory even if you remove the disc from the player or switch off the player. If you load a disc that has the scene memorized, the scene is automatically recalled.

#### Note:

This player does not memorize the scene of a disc if you switch off the player before commencing to play the disc.

### Screen Saver

The screen saver appears when you leave the DVD player in Stop mode for about five minutes. If the Screen Saver is displayed for five minutes, the DVD Player automatically turns itself off.

### System Select

You must select the appropriate system mode for your TV system. If NO DISC appears in the display window, press and hold PAUSE/STEP for more than 5 seconds to be able to select a system (PAL, NTSC).

## DVD Audio Discs

DVD Audio is a new disc format building on the success of DVD to provide high quality, uncompressed, multi-channel audio for a new experience in audio quality. A DVD Audio disc can be identified by the DVD audio logo on the disc jacket or on the disc itself.

DVD Audio can provide higher quality stereo than Audio CDs with a sampling rate of up to 192kHz (compared to 44.1kHz for CDs). DVD Audio digital sound can be delivered with up to 24 bits of data (compared to 16 bits for a standard CD).

A typical DVD Audio disc contains up to seven times the data capacity of a CD. This additional space is used for music, either Advanced Resolution multi-channel sound quality that is closer to the artist's master recording or for longer recordings. Many DVD Audio discs contain on-screen text, such as artist biographies, playlists, or lyrics. Some DVD Audio discs contain photo galleries or video clips.

### Moving to another GROUP

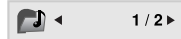

Some DVD Audio discs divide content into different groups. Your player enables you to quickly access different groups during playback via the on-screen display.

1. Press DISPLAY during playback on in stop mode.
2. Press ▲▼ to select Group icon.
3. Press ◀▶ or the numbered buttons (0-9) to select a group number.

#### **Note:**

Sometimes the author of the disc creates hidden content that can only be accessed by entering a password. If the lock icon appears on the TV screen, enter the password (sometimes you'll find it on the disc's jacket cover or on a web site). This password control isn't dictated by your DVD Player — it is a function of the disc.

Since the authoring of DVD Audio Discs varies, some of the on-screen display choices might not be available for the disc you're playing.

### Viewing another PAGE

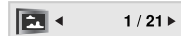

Since DVD Audio discs can hold a lot of content, there are various ways to see what's available on the disc.

1. Press DISPLAY during playback.
2. Press ▲▼ to select Page icon.
3. Press ◀▶ to select a page number.

What appears on the screen will vary from disc to disc because the information available depends upon the way the disc was created.

#### **Note:**

Since the authoring of DVD Audio Discs varies, some of the on-screen display choices might not be available for the disc you're playing.

## Playing an Memory Card

### (DNX190MH ONLY)

You can play Photo, Music, and MOVIE files in Memory Cards with this DVD player.

1. Insert a Memory Card until it fits into place.
2. Press MEMORY on the front panel.  
The Memory Card slot choice menu appears on the TV screen.

#### **Note:**

If both slots are connected with Memory Card, use ◀ / ▶ to select the desired Memory Card slot.

3. Press ENTER.  
The menu appears.
4. Press MEMORY to exit the menu.

**For details on each operation item, refer to relevant page. (See page 20-22)**

### Cards capable of displaying

#### **Readable Cards**

- Compact Flash Card (CF)
- Micro Drive (MD), ST1 MD
- Secure Digital Card (SD), Mini SD
- Multi Media Card (MMC), MMC Plus, RS MMC, MMC Mobile
- xD-Picture Card (xD)
- Memory Stick (MS), MS Duo, MS Pro, MS Pro Duo
- Compatible with: FAT 12, FAT 16, or FAT 32
- Only use the memory cards recommended.

#### **Regarding Write Protect**

For cards that have a write protect switch, if the switch is on it will not be possible to write or erase the contents of the card.

#### **Notes:**

- Keep the memory card out of reach of children.  
If swallowed, seek medical advice immediately.
- This player can not format a memory card.
- The reading time depends on file size or resolution.
- If a folder in your memory cards have more than 1012 files, the whole files are not available to read.
- This unit cannot play back the Divx file in the MMC.



#### **Caution**

Before you extract your memory cards, you should press the MEMORY button to display the DVD menu screen. Otherwise you will lose your data in your memory card or the memory card can be damaged.

## Playing an USB

### (DNX190UH ONLY)

1. Connect the USB device to the USB port on the front panel after power is on.
2. Press MEMORY on the front panel.  
The USB choice menu appears on the TV screen.
3. Press ENTER.  
The menu appears.
4. Press MEMORY to exit the menu.

#### **To Remove the USB from the unit**

1. Press MEMORY to exit the menu.
2. Remove the USB from the unit.

**For details on each operation item, refer to relevant page.(See page 20-22)**

#### **Notes:**

- Do not extract the USB device in operating.
- Music files (MP3/WMA), image files (JPEG) and Divx files can be played.
- This unit can not use USB HUB.
- This unit is not supported when the total number of files is 1000 or more.
- The USB function of this unit does not support all USB devices.
- This unit supports only USB Flash Memory.
- This unit can support USB1.1.

## Playing an Audio CD or MP3/WMA file

This unit can play Audio CDs or MP3/WMA files recorded media.

### MP3/ WMA/ Audio CD

Once you insert an MP3/WMA files recorded media or Audio CD, a menu appears on the TV screen.

Press ▲ / ▼ to select a track/file then press PLAY or ENTER and playback starts. You can use variable playback functions. (Refer to page 16-17.)

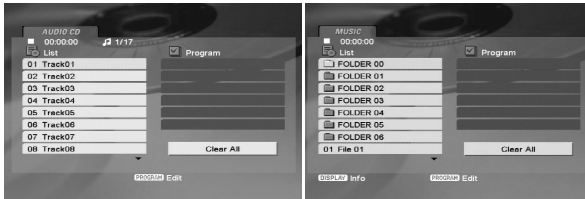

### ID3 TAG

- When playing a file containing information such as track titles, you can see the information by pressing DISPLAY.  
[ Song, Artist, Album, Comment, Genre ]

### Tips:

- Press DVD MENU to move to the next page.
- On a CD with MP3/WMA and JPEG you can switch MP3/WMA and JPEG. Press TITLE and MUSIC or PHOTO word on top of the menu is highlighted.

### MP3 / WMA disc compatibility with this player is limited as follows:

- Sampling frequency: within 8 - 48 kHz (MP3), within 32 - 48kHz (WMA)
- Bit rate: within 8 - 320kbps (MP3), 32 - 384 kbps (WMA)
- The player cannot read an MP3/WMA file that has a file extension other than “.mp3” / “.wma”.
- CD-R physical format should be ISO 9660
- If you record MP3 / WMA files using software that cannot create a file system (eg. Direct-CD) it is impossible to playback MP3 / WMA files. We recommend that you use Easy-CD Creator, which creates an ISO 9660 file system.
- File names should have a maximum of 8 letters and must incorporate an .mp3 or .wma extension.
- They should not contain special letters such as / ? \* : “ < > | etc.
- The total number of files in a folder should be less than 1012 files.

## Programmed Playback

The program function enables you to store your favorite tracks from any disc in the player memory. A program can contain 30 tracks.

1. Insert an Audio CD or MP3/WMA files recorded media. AUDIO CD or MUSIC menu appears.
2. Press PROGRAM and the **Ⓜ** mark will appear

### Note:

Press PROGRAM again to exit the program edit mode, then the **Ⓜ** mark will disappear.

3. Select a track on the “List”, then press ENTER to place the selected track on the “Program” list. Repeat to place additional tracks on the list.
4. Select the track you want to start playing on the “Program” list.
5. Press PLAY or ENTER to start. Playback begins in the order in which you programmed the tracks. Playback stops after all of the tracks on the “Program” list have played once.
6. To resume normal playback from programmed playback, select a track on the list and then press PLAY.

### Repeat Programmed Tracks

Press REPEAT to select a desired repeat mode.

- Track: repeats the current track
- All: repeats all the tracks on programmed list.
- Off(No display): does not play repeatedly.

### Note:

If you press **▶▶** once during Repeat Track playback, the repeat playback cancels.

### Erasing a Track from “Program” List

1. During STOP mode, press PROGRAM and the **Ⓜ** mark will appear
2. Use ▲ ▼ ◀ ▶ to select the track that you wish to erase from the Program list.
3. Press CLEAR. Repeat step 1~3 to erase additional tracks on the list.

### Erasing the Complete Program List

1. During STOP mode, press PROGRAM and the **Ⓜ** mark will appear
2. Use ▲ ▼ ◀ ▶ to select “Clear All”, then press ENTER.

### Note:

The programs are also cleared when the power is off or the disc is removed.

## Viewing a JPEG file

This unit can play JPEG files recorded media.

1. Insert a JPEG files recorded media. The PHOTO menu appears on the TV screen.

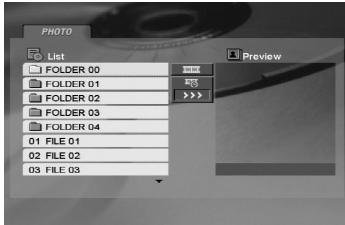

2. Press ▲ / ▼ to select a folder, and press ENTER. A list of files in the folder appears.
3. If you want to view a particular file, press ▲ / ▼ to highlight a file and press ENTER or PLAY.
4. To return to the PHOTO menu while watching pictures, press STOP.

### Tips:

- If you are in a file list and want to return to the previous Folder list, use ▲ / ▼ buttons to highlight and press ENTER.
- Press DVD MENU to move to the next page.
- There are three Slide Speed options : >>> (Fast), >> (Normal) and > (Slow). Use ▲ ▼ ◀ ▶ to highlight . Then, use ◀ / ▶ to select the option you want to use then press ENTER.
- On a disc with MP3/WMA and JPEG you can switch MP3/WMA and JPEG. Press TITLE and MUSIC or PHOTO word on top of the menu is highlighted.
- While watching a picture, press RETURN to hide the help menu.
- When viewing a JPEG file, the help menu will not be displayed on the TV screen if the resolution is set to 720p or 1080i.

### Slide Show

Use ▲ ▼ ◀ ▶ to highlight the (Slide Show) then press ENTER.

### Still Picture

1. Press PAUSE/STEP during slide show. The player will now go into PAUSE mode.
2. To return to the slide show, press PLAY or press PAUSE/STEP again.

### Moving to another File

Press SKIP (◀◀ or ▶▶) or cursor (◀ or ▶) once while viewing a picture to advance to the next or previous file.

### Zoom

During watching pictures, press ZOOM to enlarge the video image (3 steps).

You can move through the zoomed picture using ◀ ▶ ▲ ▼ buttons.

### Note:

When the resolution is set to 720p or 1080i, this function is not available.

### To rotate picture

Press ▲ / ▼ during showing a picture to rotate the picture clockwise or counter clockwise.

### To listen to MP3 music while watching picture

1. Insert the disc containing the two types of file in the player.
2. Press TITLE to display PHOTO menu.
3. Press ▲ / ▼ to select a photo file.
4. Use ▶ to select icon then press ENTER. Playback starts. The playback will continue until STOP is pressed.

### Notes:

- When the resolution is set to 720p or 1080i, this function is not available.
- This function is not available for Memory Card.

### Tip:

To listen to only the desired music while watching picture, program the desired tracks from the "MUSIC" menu and then proceed as above.

### JPEG disc compatibility with this player is limited as follows:

- Depending upon the size and number of JPEG files, it could take a long time for the DVD player to read the disc's contents. If you do not see an on-screen display after several minutes, some of the files may be too large — reduce the resolution of the JPEG files to less than 5 million pixels and burn another disc.
- The total number of files in a folder should be less than 1012 files.
- Some discs may be incompatible due to a different recording format or the condition of disc.
- Ensure that all the selected files have the ".jpg" extensions when copying into the CD layout.
- If the files have ".jpe" or ".jpeg" extensions, please rename them as ".jpg" file.
- File names without ".jpg" extension will not be able to be read by this unit. Even though the files are shown as JPEG image files in Windows Explorer.

## Playing a DivX Movie file

Using this DVD Player you can play DivX file.

1. Insert a DivX file recorded media. The MOVIE menu appears on the TV screen.



2. Press ▲ / ▼ to select a folder, and press ENTER. A list of files in the folder appears.
3. If you want to view a particular file, press ▲ / ▼ to highlight a file and press ENTER or PLAY. You can use variable playback functions. (Refer to page 16-17.)
4. Press STOP to stop the playback. The Movie menu appears

### Tips:

- If you are in a file list and want to return to the previous Folder list, use the ▲ / ▼ buttons on the remote to highlight  and press ENTER.
- Press DVD MENU to move to the next page.
- On a CD with MP3/WMA, JPEG and MOVIE file, you can switch MUSIC, PHOTO and MOVIE menu. Press TITLE and MUSIC, PHOTO and MOVIE word on top of the menu is highlighted.
- The picture may not displayed properly while DivX playback. Set your TV system to AUTO or PAL-60 mode to restore the picture, if available.
- The disc subtitle may not be displayed properly, if a DivX subtitle is downloaded through the internet.
- If the Disc Subtitle setup menu does not have the DivX subtitle language you are going to play, the subtitle may not be displayed properly.

### Notice for displaying the DivX subtitle

If the subtitle does not display properly during playback, press and hold SUBTITLE about 3 seconds then press ◀ / ▶ to select another language code until the subtitle is displayed properly.

### Note:

When the bitrate of video signal on a DivX file stored in a memory card/USB is over 2Mbps, it can be displayed like a still image.

### DivX disc compatibility with this player is limited as follows:

- Available resolution size of the DivX file is under 720x576 (W x H) pixel.
- The file name of the DivX subtitle is available by 56 characters.
- If there is impossible code to express in the DivX file, it may be displayed as “\_” mark on the display.
- **If the number of the screen frame is over 30 per 1 second, this unit may not operate normally.**
- **If the video and audio structure of recorded file is not interleaved, either video or audio is outputted.**
- **If the file is recorded with GMC, the unit supports only 1-point of the record level.**
  - \* GMC?
  - GMC is the acronym for Global Motion Compensation. It is an encoding tool specified in MPEG4 standard. Some MPEG4 encoders, like DivX or Xvid, have this option. There are different levels of GMC encoding, usually called 1-point, 2-point, or 3-point GMC.

### Playable DivX file

.avi, .mpg, .mpeg

### Playable Subtitle format

SubRip(\*.srt/\*.txt)  
SAMI(\*.smi)  
SubStation Alpha(\*.ssa/\*.txt)  
MicroDVD(\*.sub/\*.txt)  
SubViewer 1.0(\*.sub)  
SubViewer 2.0(\*.sub/\*.txt)  
TMPlayer(\*.txt)

### Playable Codec format

“DIVX3.xx”, “DIVX4.xx”, “DIVX5.xx”, “XVID”, “MP43”, “3IVX”.

### Playable Audio format

- “Dolby Digital”, “DTS”, “PCM”, “MP3”, “WMA”.
- Sampling frequency: within 8 - 48 kHz (MP3), within 32 - 48kHz (WMA)
  - Bit rate: within 8 - 320kbps (MP3), 32 - 384kbps (WMA)
  - Not all the WMA Audio format is compatible with this unit.

## Controlling other TVs with the remote control

You can control the sound level, input source, and power switch of your LG TV with the supplied remote control.

You can control the sound level, input source, and power switch of non-LG TVs as well. If your TV is listed in the table below, set the appropriate manufacturer code.

1. While holding down TV POWER button, press the number buttons to select the manufacturer code for your TV (see the table below).
2. Release TV POWER button.

### Code numbers of controllable TVs

If more than one code number is listed, try entering them one at a time until you find the one that works with your TV.

Manufacturer	Code Number
LG / GoldStar	1 (Default), 2
Zenith	1, 3, 4
Samsung	6, 7
Sony	8, 9
Hitachi	4

### Notes:

- Depending on your TV, some or all buttons may not function on the TV, even after entering the correct manufacturer code.
- If you enter a new code number, the code number previously entered will be erased.
- When you replace the batteries of the remote, the code number you have set may be reset to the default setting. Set the appropriate code number again.

## Maintenance and Service

Refer to the information in this chapter before contacting a service technician.

### Handling the Unit

#### When shipping the unit

Please save the original shipping carton and packing materials. If you need to ship the unit, for maximum protection, re-pack the unit as it was originally packed at the factory.

#### Keeping the exterior surfaces clean

- Do not use volatile liquids such as insecticide spray near the unit.
- Do not leave rubber or plastic products in contact with the unit for a long period of time. since they leave marks on the surface.

#### Cleaning the unit

To clean the player, use a soft, dry cloth. If the surfaces are extremely dirty, use a soft cloth lightly moistened with a mild detergent solution.

Do not use strong solvents such as alcohol, benzene, or thinner, as these might damage the surface of the unit.

#### Maintaining the Unit

The unit is a high-tech, precision device. If the optical pick-up lens and disc drive parts are dirty or worn, the picture quality could be diminished.

Depending on the operating environment, regular inspection and maintenance are recommended after every 1,000 hours of use.

For details, please contact your nearest authorized service center.

# Reference

## Language Codes

Use this list to input your desired language for the following initial settings:  
Disc Audio, Disc Subtitle, Disc Menu.

Language	Code	Language	Code	Language	Code	Language	Code
Abkhazian	6566	Fiji	7074	Lingala	7678	Singhalese	8373
Afar	6565	Finnish	7073	Lithuanian	7684	Slovak	8375
Afrikaans	6570	French	7082	Macedonian	7775	Slovenian	8376
Albanian	8381	Frisian	7089	Malagasy	7771	Somali	8379
Ameharic	6577	Galician	7176	Malay	7783	Spanish	6983
Arabic	6582	Georgian	7565	Malayalam	7776	Sudanese	8385
Armenian	7289	German	6869	Maltese	7784	Swahili	8387
Assamese	6583	Greek	6976	Maori	7773	Swedish	8386
Aymara	6588	Greenlandic	7576	Marathi	7782	Tagalog	8476
Azerbaijani	6590	Guarani	7178	Moldavian	7779	Tajik	8471
Bashkir	6665	Gujarati	7185	Mongolian	7778	Tamil	8465
Basque	6985	Hausa	7265	Nauru	7865	Tatar	8484
Bengali; Bangla	6678	Hebrew	7387	Nepali	7869	Telugu	8469
Bhutani	6890	Hindi	7273	Norwegian	7879	Thai	8472
Bihari	6672	Hungarian	7285	Oriya	7982	Tibetan	6679
Breton	6682	Icelandic	7383	Panjabi	8065	Tigrinya	8473
Bulgarian	6671	Indonesian	7378	Pashto, Pushto	8083	Tonga	8479
Burmese	7789	Interlingua	7365	Persian	7065	Turkish	8482
Byelorussian	6669	Irish	7165	Polish	8076	Turkmen	8475
Cambodian	7577	Italian	7384	Portuguese	8084	Twi	8487
Catalan	6765	Japanese	7465	Quechua	8185	Ukrainian	8575
Chinese	9072	Javanese	7487	Rhaeto-Romance	8277	Urdu	8582
Corsican	6779	Kannada	7578	Rumanian	8279	Uzbek	8590
Croatian	7282	Kashmiri	7583	Russian	8285	Vietnamese	8673
Czech	6783	Kazakh	7575	Samoan	8377	Volapük	8679
Danish	6865	Kirghiz	7589	Sanskrit	8365	Welsh	6789
Dutch	7876	Korean	7579	Scots Gaelic	7168	Wolof	8779
English	6978	Kurdish	7585	Serbian	8382	Xhosa	8872
Esperanto	6979	Laothian	7679	Serbo-Croatian	8372	Yiddish	7473
Estonian	6984	Latin	7665	Shona	8378	Yoruba	8979
Faroese	7079	Latvian, Lettish	7686	Sindhi	8368	Zulu	9085

## Area Codes

Choose a Area code from this list.

Area	Code	Area	Code	Area	Code	Area	Code
Afghanistan	AF	Ethiopia	ET	Malaysia	MY	Saudi Arabia	SA
Argentina	AR	Fiji	FJ	Maldives	MV	Senegal	SN
Australia	AU	Finland	FI	Mexico	MX	Singapore	SG
Austria	AT	France	FR	Monaco	MC	Slovak Republic	SK
Belgium	BE	Germany	DE	Mongolia	MN	Slovenia	SI
Bhutan	BT	Great Britain	GB	Morocco	MA	South Africa	ZA
Bolivia	BO	Greece	GR	Nepal	NP	South Korea	KR
Brazil	BR	Greenland	GL	Netherlands	NL	Spain	ES
Cambodia	KH	Herd and Mcdonald Islands	HM	Netherlands Antilles	AN	Sri Lanka	LK
Canada	CA	Hong Kong	HK	New Zealand	NZ	Sweden	SE
Chile	CL	Hungary	HU	Nigeria	NG	Switzerland	CH
China	CN	India	IN	Norway	NO	Taiwan	TW
Colombia	CO	Indonesia	ID	Oman	OM	Thailand	TH
Congo	CG	Israel	IL	Pakistan	PK	Turkey	TR
Costa Rica	CR	Italy	IT	Panama	PA	Uganda	UG
Croatia	HR	Jamaica	JM	Paraguay	PY	Ukraine	UA
Czech Republic	CZ	Japan	JP	Philippines	PH	United States	US
Denmark	DK	Kenya	KE	Poland	PL	Uruguay	UY
Ecuador	EC	Kuwait	KW	Portugal	PT	Uzbekistan	UZ
Egypt	EG	Libya	LY	Romania	RO	Vietnam	VN
El Salvador	SV	Luxembourg	LU	Russian Federation	RU	Zimbabwe	ZW



## Troubleshooting

Symptom	Possible Cause	Correction
No power.	<ul style="list-style-type: none"> <li>The power cord is disconnected.</li> </ul>	<ul style="list-style-type: none"> <li>Plug the power cord into the wall outlet securely.</li> </ul>
The power is on, but the DVD player does not work.	<ul style="list-style-type: none"> <li>No disc is inserted.</li> </ul>	<ul style="list-style-type: none"> <li>Insert a disc. (Check the disc indicator in the display window is lit.)</li> </ul>
No picture.	<ul style="list-style-type: none"> <li>The TV is not set to receive DVD signal output.</li> </ul>	<ul style="list-style-type: none"> <li>Select the appropriate video input mode on the TV.</li> </ul>
	<ul style="list-style-type: none"> <li>The video cable is not connected securely.</li> </ul>	<ul style="list-style-type: none"> <li>Connect the video cable securely.</li> </ul>
No sound.	<ul style="list-style-type: none"> <li>The equipment connected with the audio cable is not set to receive DVD signal output.</li> </ul>	<ul style="list-style-type: none"> <li>Select the correct input mode of the audio receiver so you can listen to the sound from the DVD player.</li> </ul>
	<ul style="list-style-type: none"> <li>The power of the equipment connected with the audio cable is turned off.</li> </ul>	<ul style="list-style-type: none"> <li>Turn on the equipment connected with the audio cable.</li> </ul>
	<ul style="list-style-type: none"> <li>The AUDIO options are set to the wrong position.</li> </ul>	<ul style="list-style-type: none"> <li>Set the AUDIO option to the correct position, then turn on the DVD player again by pressing POWER.</li> </ul>
The DVD player does not start playback.	<ul style="list-style-type: none"> <li>An unplayable disc is inserted.</li> </ul>	<ul style="list-style-type: none"> <li>Insert a playable disc. (Check the disc type and regional code.)</li> </ul>
	<ul style="list-style-type: none"> <li>The rating level is set.</li> </ul>	<ul style="list-style-type: none"> <li>Change the rating level.</li> </ul>
The remote control does not work properly.	<ul style="list-style-type: none"> <li>The remote control is not pointed at the remote sensor on the DVD player.</li> </ul>	<ul style="list-style-type: none"> <li>Point the remote control at the remote sensor of the DVD player.</li> </ul>
	<ul style="list-style-type: none"> <li>The remote control is too far from the DVD player.</li> </ul>	<ul style="list-style-type: none"> <li>Operate the remote control closer to the DVD player.</li> </ul>

## Specifications

### General

**Power requirements:** AC 200-240 V , 50/60 Hz

**Power consumption:** 10W

**Dimensions (Approx.):**

430 x 35 x 242 mm (17 x 1.4 x 9.5 inches)  
(W x H x D) without foot

**Weight (Approx.):** 1.9 kg (4.2 lbs)

**Operating temperature:**

5 °C to 35 °C (41 °F to 95 °F)

**Operating humidity:** 5 % to 90 %

### Outputs

**VIDEO OUT:**

1.0 V (p-p), 75 Ω, sync negative, RCA jack x 1 / SCART (TO TV)

**COMPONENT VIDEO OUT:**

(Y) 1.0 V (p-p), 75 Ω, negative sync, RCA jack x 1  
(Pb)/(Pr) 0.7 V (p-p), 75 Ω, RCA jack x 2

**AUDIO OUT:**

2.0 Vrms (1 KHz, 0 dB), 600 Ω, RCA jack (L, R) x 1 / SCART (TO TV)

**Note:** Design and specifications are subject to change prior notice.

**DIGITAL OUT (COAXIAL):**

0.5 V (p-p), 75 Ω, RCA jack x 1

**DIGITAL OUT (OPTICAL):**

3 V (p-p), 75 Ω, Optical jack x 1

### System

**Laser:**

Semiconductor laser, wavelength 650 nm

**Signal system:** PAL / NTSC

**Frequency response:**

DVD (PCM 96 kHz): 8 Hz to 44 kHz

DVD (PCM 48 kHz): 8 Hz to 22 kHz

CD: 8 Hz to 20 kHz

**Signal-to-noise ratio:**

More than 100 dB (ANALOG OUT connectors only)

**Harmonic distortion:** Less than 0.008%

**Dynamic range:**

More than 95 dB (DVD/CD)

**Accessories:**

Video cable (1), Audio cable (1), Remote control (1), Batteries (2)



Technology with the human touch

## GUARANTEE

- LG Electronics U.K. Ltd. will provide the following services in order to expedite this Guarantee.
- 1. All faulty components which fail due to defective manufacture will be replaced free of charge for a period of 12 months from the original date of purchase.
- 2. The dealer (or his service agent) who sold the product will be reimbursed for any labour provided in the repair of this LG equipment, for a period of 12 months from the original date of purchase. These claims must be made in accordance with the published scale of service charges and relevant claims procedure.

### PLEASE NOTE:

- A. The dealer may restrict the guarantee to the original purchaser.
- B. The dealer is not obliged to carry out service under guarantee if unauthorized modifications are made to the apparatus, or if non standard components are used or if the serial number of the apparatus is removed, defaced, misused, or altered.
- C. Any claims made under guarantee must be directed to the dealer from whom the equipment was originally purchased. The dealer may, before carrying out service under guarantee, require a receipted account as evidence of the date of purchase.
- D. We respectfully point out that your dealer is not obligated to replace batteries if they become exhausted or worn in use.
- E. Aerial alignment and consumer control adjustments are not covered by this guarantee.

This guarantee does not affect your statutory rights.

### ● REQUIREMENTS TO MAINTAIN WARRANTY COVERAGE:

RETAIN YOUR RECEIPT TO PROVE DATE OF PURCHASE. A COPY OF YOUR RECEIPT MUST BE SURRENDERED AT THE TIME GUARANTEE SERVICE IS PROVIDED.

- Product Registration Card : It is helpful to complete at least your name, address, phone, model & serial numbers and return it. This will enable LG to assist you in the future should you lose your receipt, your units be stolen, or should modifications be necessary.
- To obtain information or assistance: Call 0870 873 5454 Monday-Friday 9.00am-4.30pm

MODEL NO.*	SERIAL NO.*	DATE OF PURCHASE.*

\* Please complete for your own record

**In all cases of difficulty - consult your LG dealer  
from whom the product was purchased**

P/NO : 3834RD0082W

## Free Manuals Download Website

<http://myh66.com>

<http://usermanuals.us>

<http://www.somanuals.com>

<http://www.4manuals.cc>

<http://www.manual-lib.com>

<http://www.404manual.com>

<http://www.luxmanual.com>

<http://aubethermostatmanual.com>

Golf course search by state

<http://golfingnear.com>

Email search by domain

<http://emailbydomain.com>

Auto manuals search

<http://auto.somanuals.com>

TV manuals search

<http://tv.somanuals.com>