



LG

Life's Good

Full HD up-scaling (1080p)
(Go to page 8)

Home theater Speaker ez Set-up
(Go to page 19)

USB Direct Recording
(Go to page 20~21)

Portable In
(Go to page 18)

DVD RECEIVER OWNER'S MANUAL

Model : HT924SF
HT855SF
HT855PF



**Before connecting, operating or adjusting this product,
please read this instruction booklet carefully and completely.**



As an ENERGY STAR® Partner,
LG has determined that this
product or product models meet
the ENERGY STAR® guidelines for
energy efficiency.

ENERGY STAR® is a U.S. registered mark.

P/No. : MFL62514302 (00)

Download from www.Somanuals.com. All Manuals Search And Download.

Dear Customer

Thank You for Purchasing the LG DVD Player. After going through the instruction manual , you will be able to enjoy all the features and functions of the Product.



CAUTION : TO REDUCE THE RISK OF ELECTRIC SHOCK DO NOT REMOVE COVER (OR BACK) NO USER-SERVICEABLE PARTS INSIDE REFER SERVICING TO QUALIFIED SERVICE PERSONNEL.



This lightning flash with arrowhead symbol within an equilateral triangle is intended to alert the user to the presence of uninsulated dangerous voltage within the product's enclosure that may be of sufficient magnitude to constitute a risk of electric shock to persons.



The exclamation point within an equilateral triangle is intended to alert the user to the presence of important operating and maintenance (servicing) instructions in the literature accompanying the product.

WARNING : TO PREVENT FIRE OR ELECTRIC SHOCK HAZARD, DO NOT EXPOSE THIS PRODUCT TO RAIN OR MOISTURE.

WARNING : Do not install this equipment in a confined space such as a book case or similar unit.

CAUTION: Do not block any ventilation openings. Install in accordance with the manufacturer's instructions.

Slots and openings in the cabinet are provided for ventilation and to ensure reliable operation of the product and to protect it from over heating.

The openings should be never be blocked by placing the product on a bed, sofa, rug or other similar surface. This product should not be placed in a built-in installation such as a bookcase or rack unless proper ventilation is provided or the manufacturer's instruction has been adhered to.

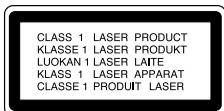

CAUTION : This product employs a Laser System.

To ensure proper use of this product, please read this owner's manual carefully and retain it for future reference. Shall the unit require maintenance, contact an authorized service center.

Use of controls, adjustments or the performance of procedures other than those specified herein may result in hazardous radiation exposure.

To prevent direct exposure to laser beam, do not try to open the enclosure. Visible laser radiation when open. DO NOT STARE INTO BEAM.

CAUTION : The apparatus shall not be exposed to water (dripping or splashing) and no objects filled with liquids, such as vases, shall be placed on the apparatus.

CAUTION : concerning the Power Cord

Most appliances recommend they be placed upon a dedicated circuit ; That is, a single outlet circuit which powers only that appliance and has no additional outlets or branch circuits. Check the specification page of this owner's manual to be certain.

Do not overload wall outlets. Overloaded wall outlets, loose or damaged wall outlets, extension cords, frayed power cords, or damaged or cracked wire insulation are dangerous. Any of these conditions could result in electric shock or fire. Periodically examine the cord of your appliance, and if its appearance indicates damage or deterioration, unplug it, discontinue use of the appliance, and have the cord replaced with an exact replacement part by an authorized service center.

Protect the power cord from physical or mechanical abuse, such as being twisted, kinked, pinched, closed in a door, or walked upon. Pay particular attention to plugs, wall outlets, and the point where the cord exits the appliance.

To disconnect power from the mains, pull out the mains cord plug. When installing the product, ensure that the plug is easily accessible.

Copyrights

It is forbidden by law to copy, broadcast, show, broadcast via cable, play in public, or rent copyrighted material without permission. This product features the copy protection function developed by Macrovision. Copy protection signals are recorded on some discs. When recording and playing the pictures of these discs picture noise will appear. This product incorporates copyright protection technology that is protected by U.S. patents and other intellectual property rights. Use of this copyright protection technology must be authorized by Macrovision, and is intended for home and other limited viewing uses only unless otherwise authorized by Macrovision. Reverse engineering or disassembly is prohibited.

CONSUMERS SHOULD NOTE THAT NOT ALL HIGH DEFINITION TELEVISION SETS ARE FULLY COMPATIBLE WITH THIS PRODUCT AND MAY CAUSE ARTIFACTS TO BE DISPLAYED IN THE PICTURE. IN CASE OF 525 OR 625 PROGRESSIVE SCAN PICTURE PROBLEMS, IT IS RECOMMENDED THAT THE USER SWITCH THE CONNECTION TO THE STANDARD DEFINITION OUTPUT. IF THERE ARE QUESTIONS REGARDING OUR TV SET COMPATIBILITY WITH THIS MODEL 525p AND 625p UNIT, PLEASE CONTACT OUR CUSTOMER SERVICE CENTER.

You have to set the disc format option to [Mastered] in order to make the discs compatible with the LG players when formatting rewritable discs. When setting the option to Live File System, you cannot use it on LG players. (Mastered/ Live File System : Disc format system for Windows Vista)

Welcome to your new DVD Receiver

Contents



Types of Playable Discs	6
Main Unit	7
Remote control	7
Speaker Setting up	9
Hooking up the unit	8~9
Initial Setting the Area Code	10
Adjusting the general settings	10-16
5.1 Speaker Setup	11
OSD Initial language settings	12



Displaying Disc Information	12
Troubleshooting	12
Operations	13
Enjoying a pre-programmed sound field	15
Other operations	15
Playing a disc or file	16
viewing photo files	18
Listening to music from your portable player or external device	18
Listening to the radio	19



Home theater Speaker ez Set-up	19
Using an USB device	20
Recording to USB	20
Language Codes	22
Area Codes	22
Specifications	22



What is SIMPLINK?

Some functions of this unit are controlled by TV's remote control when this unit and LG TV with SIMPLINK are connected through HDMI connection.

- Controllable functions by LG TV's remote control; Play, Pause, Scan, Skip, Stop, Power Off, etc.
- Refer to the TV owner's manual for the details of SIMPLINK function.
- LG TV with SIMPLINK function has the logo as shown above.
- Use a higher version cable than 1.2A HDMI cable.

Introduction

To ensure proper use of this product, please read this owner's manual carefully and retain it for future reference.

This manual provides information on the operation and maintenance of your DVD player. Should the unit require service, contact an authorized service location.

About the Symbol Display

"" may appear on your TV display during operation and indicates that the function explained in this owner's manual is not available on that specific DVD video disc.

Symbol Used in this Manual

 The lightning flash symbol alerts you to the presence of dangerous voltage within the product enclosure that may constitute a risk of electric shock.

 The exclamation point alerts you to the presence of important operating and maintenance / servicing instructions.

 Indicates hazards likely to cause harm to the unit itself or other material damage.









Note :

Indicates special notes and operating features.

Tip :

Indicates tips and hints for making the task easier.

A section whose title has one of the following symbols is applicable only to the disc represented by the symbol.

-  All discs listed below
-  DVD and finalized DVD \pm R/RW
-  Video CDs
-  Audio CDs
-  MP3 files
-  WMA files
-  DivX files
-  CD-G Discs

Notes on Discs

Handling Discs

Do not touch the playback side of the disc. Hold the disc by the edges so that fingerprints do not get on the surface. Never stick paper or tape on the disc.



" Always keep a disc inside the player to prevent optical lens damage due to dust "

Storing Discs

After playing, store the disc in its case. Do not expose the disc to direct sunlight or sources of heat and never leave it in a parked car exposed to direct sunlight.

Cleaning Discs

Fingerprints and dust on the disc can cause poor picture quality and sound distortion. Before playing, clean the disc with a clean cloth. Wipe the disc from the center out.

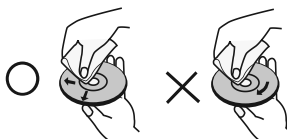

Do not use strong solvents such as alcohol, benzene, thinner, commercially available cleaners, or anti-static spray intended for older vinyl records.

Maintenance and Service

Refer to the information in this chapter before contacting a service technician.

Place a disc inside when not in use

Handling the Unit

When shipping the unit

Please save the original shipping carton and packing materials. If you need to ship the unit, for maximum protection, re-pack the unit as it was originally packed at the factory. It is recommended to remove any disc from the player while moving the set

Keeping the exterior surfaces clean

- Do not use volatile liquids such as insecticide spray near the unit.
- Do not leave rubber or plastic products in contact with the unit for a long period of time, since they leave marks on the surface.

Cleaning the unit

To clean the player, use a soft, dry cloth. If the surfaces are extremely dirty, use a soft cloth lightly moistened with a mild detergent solution.

Do not use strong solvents such as alcohol, benzene, or thinner, as these might damage the surface of the unit.







Maintaining the Unit

The DVD player is a high-tech, precision device. If the optical pick-up lens and disc drive parts are dirty or worn, the picture quality could be diminished.

Depending on the operating environment, regular inspection and maintenance are recommended after every 1,000 hours of use.

For details, please contact your nearest authorized service center.

Types of Playable Discs

Type	Logo
DVD-VIDEO: Discs such as movies that can be purchased or rented.	
DVD-R: Video mode and finalized only	
DVD-RW: VR mode, Video mode and finalized only	
DVD±R: Video mode only	
DVD±RW: Video mode only	
Audio CD: Music CDs or CD-R/CD-RW in music CD format that can be purchased.	

This unit plays DVD±R/RW and CD-R/RW that contains audio titles, DivX, MP3, WMA and/or JPEG files. Some DVD±RW/DVD±R or CD-RW/CD-R cannot be played on this unit due to the recording quality or physical condition of the disc, or the characteristics of the recording device and authoring software.

Regional Codes

This unit has a regional code printed on the rear of the unit. This unit can play only DVD discs labeled same as the rear of the unit or "ALL".

- Most DVD discs have a globe with one or more numbers in it clearly visible on the cover. This number must match your unit's regional code or the disc cannot play.
- If you try to play a DVD with a different regional code from your player, the message "Check Regional Code" appears on the TV screen.

"Dolby", "Pro Logic", and the double-D symbol are trademarks of Dolby Laboratories. Manufactured under license from Dolby Laboratories.

Manufactured under license under U.S. Patent #'s: 5,451,942; 5,956,674; 5,974,380; 5,978,762; 6,487,535 & other U.S. and worldwide patents issued & pending. DTS and DTS Digital Surround are registered trademarks and the DTS logos and Symbol are trademarks of DTS, Inc. © 1996-2007 DTS, Inc. All Rights Reserved.

HDMI, the HDMI logo and High-Definition Multimedia Interface are trademarks or registered trademarks of HDMI licensing LLC.

About the Symbol Display

'' may appear on your TV display during operation and indicates that the function explained in this owner's manual is not available on that specific DVD video disc.

Manufactured under license from Dolby Laboratories. "Dolby" and the double-D symbol are trademarks of Dolby Laboratories.

Disc-related terms

DVD ±R / DVD ±RW

DVD -R and DVD +R are two different standards for recordable DVD drives and discs. This format allows information to be recorded onto the DVD disc only once. DVD +RW and DVD -RW are two standards for re-writable media, meaning the DVD content can be erased and re-recorded.

VCD (Video CD)

A VCD holds up to 74 minutes (650 MB disc) or 80 minutes (700 MB disc) of MPEG-1 full-motion video along with quality stereo sound.

MPEG

MPEG is an international standard for video and audio compression. MPEG-1 is used in encoding video for VCD and provides for multichannel surround sound coding such as PCM, Dolby Digital, DTS and MPEG audio.

MP3

MP3 is a popular compression format used for digital audio files that yields very high near-CD quality.

WMA

Windows media audio file. A type of coding / decoding developed by Microsoft Corp.

JPEG

Joint Pictures Expert Group. JPEG is a compressed file format that allows you to save images with no limit on the number of colors.

DivX

DivX is the name of a revolutionary new video codec which is based on the new MPEG-4 (MP-4) compression standard for video. You will be able to play DivX movies using this DVD player.

Note: This player does not support all MP4 formats.

PBC: Playback Control (Video CD only)

Playback control is available for Video CD (VCD) version 2.0 disc formats. PBC allows you to interact with the system via menus, search functions, or other typical computer-like operations. Moreover, still pictures of high resolution can be played if they are included in the disc. Video CDs not equipped with PBC (Version 1.1) operate in the same way as audio CDs.

Title (DVD video discs only)

A title is generally a distinct section of a DVD disc. For example the main feature could be title 1, a documentary describing how the film was made could be title 2, and cast interviews could be title 3. Each title is assigned a reference number enabling you to locate it easily.

Chapter (DVD video discs only)

A chapter is a segment of a title such as a scene in a film or one interview in a series. Each chapter is assigned a chapter number, enabling you to locate the chapter you want. Depending on the disc, chapters may not be recorded.

Scene (VCD)

On a video CD with PBC (playback control) functions, moving pictures and still pictures are divided into sections called "scenes". Each scene is displayed in the menu screen and assigned a scene number, enabling you to locate the scene you want. A scene is composed of one or several tracks.

Track

A distinct element of audiovisual information, such as the picture or sound track for a specific language (DVD), or a musical piece on a video or audio CD. Each track is assigned a track number, enabling you to locate the track you want. DVD discs allow one track of video (with multiple angles) and several tracks of audio.

Main Unit

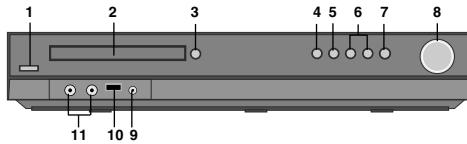

1 Power (⏻)

Turns the unit on and off.

2 DVD/CD Disc Drawer

3 Open/Close (▲)

4 Play/Pause (▶/⏸)

5 Stop (■)

6 TUNING (-/+), (◀▶), Skip / Search

7 Function (F)

Selects the function and input source.(DVD/CD, USB, AUX, AUX OPT, PORTABLE, FM, AM)

8 Volume (VOLUME)

Controls the volume when using any function.

9 PORT. (Portable) IN port

You can enjoy music from portable device on your unit.

10 USB port

You can play video, image and sound files by connecting the device.

11 MIC 1/ MIC 2

Connect a microphone to MIC 1 or MIC 2 to both sockets. You cannot use the microphone when DivX files playback or you select AUX OPT function.

Remote control

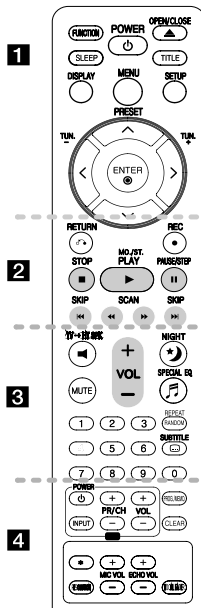

1

FUNCTION : Selects the function and input source. (DVD/CD, USB, AUX, AUX OPT, PORTABLE, FM, AM)

SLEEP : Sets the System to turn off automatically at a specified time. (Dimmer : The front panel display is dimmed.)

POWER : Switches the unit ON or OFF.

OPEN/CLOSE : Opens and closes the disc Drawer.

TITLE : If the current DVD title has a menu, the title menu appears on the screen. Otherwise, the disc Title menu may not appear.

DISPLAY : Accesses On-Screen Display.

MENU : Accesses the menu on a DVD disc.

SETUP : Accesses or removes setup menu.

PRESET (▲ ▼) : Selects programme of Radio.

TUN. (-/+) : Tunes in the desired radio station.

▲ ▼ <> (up/ down/ left/ right): Used to navigate on-screen displays.

ENTER : Acknowledges menu selection.

2

RETURN (↶) : moving backwards in the menu or exited the setup menu.

REC (●) : USB Direct Recording

STOP (■) : Stops playback or recording.

PLAY (▶), MO./ST. : Starts playback. Selects Mono/Stereo.

PAUSE/STEP (⏸) : Pause playback.

SKIP (◀▶) : Go to next or previous chapter/ track/ file.

SCAN (◀▶▶) : Search backward or forward.

Put the battery into the remote control

Make sure that the + (plus) and - (minus) on the battery match those on the remote control.

3 TV → HT SPK (Home theater Speaker ez Set-up) :

Press TV → HT SPK to select the AUX OPT directly.
MUTE : To mute the sound.

VOL (Volume) (+/-) : Adjusts speaker volume.

NIGHT : The night mode is to improve listenable at lower volumes.

DEMO : Quick access to India Optimised EQ Mode.

SPECIAL EQ (EQUALIZER effect) : You can choose sound impressions (LG Sound Gallery).

REPEAT/RANDOM : To select a play mode.

(Repeat, Random).

SUBTITLE : During playback, press SUBTITLE repeatedly to select a desired subtitle language.

0-9 numerical buttons : Selects numbered options in a menu.

4 TV Control buttons : Controls the TV. (LG TV only)

Controlling the TV.

You can control the sound level, input source, and power switching of LG TVs as well. Hold POWER (TV) and press PR/CH (+/-) button repeatedly until the TV turns on or off.

PROG./MEMO. : Accesses or removes Program menu stores FM Channels.

CLEAR : Removes a track number on the Program List.
RESOLUTION : Sets the output resolution for HDMI and COMPONENT VIDEO OUT jacks.

ECHO VOL. : Adjusts echo volume.

MIC VOL. : Adjusts microphone volume.

VOCAL FADER : You can enjoy the function as karaoke, by reducing singer vocal of music in the various source.

★ : This button is not available.

Hooking up the unit

- 1** Connect jacks on the unit and your TV (DVD player or Digital Device etc.) using the cables. Check the jacks of your TV, and choose the **A**, **B** or **C** connection. Picture quality improves in order from **A** to **C**.

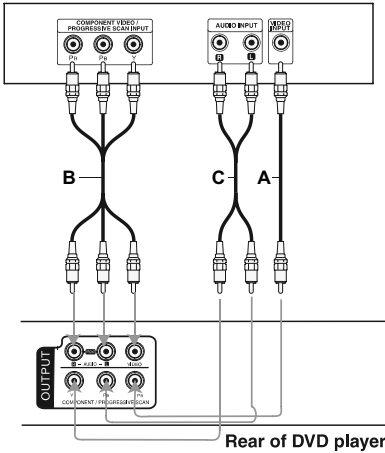
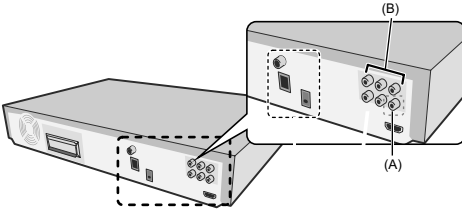

Audio In connection

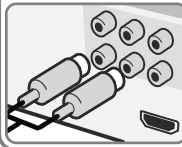

The unit's Audio jacks are colour coded (red for right audio and white for left audio). If your TV has only one output for audio (mono), connect it to the left (white) audio jack on the unit.

AM FM connection

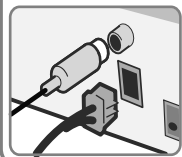

AM - Connect the AM loop aerial to the DVD receiver. FM - Connect the FM aerial. The reception will be its best when the two loose ends of the aerial are in a straight and horizontal line.

- 2** Plug the power cord into the power source

Resolution Setting

You can change the resolution for component video and HDMI output.

Press **RESOLUTION** repeatedly to select the desired resolution - 480i (or 576i), 480p (or 576p), 720p, 1080i, 1080p. The resolution may not be selected depending on the connection or TV.

- Depending on your TV, some of the resolution settings may result in the picture disappearing or an abnormal picture appearing. In this case, press **RESOLUTION** repeatedly until the picture re-appears.

You can set 1080p video resolution to enjoy Full HD picture quality. (Full HD up-scaling)

Video Out connection (A)

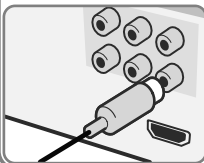

Connect the VIDEO OUTPUT(MONITOR) jack on the unit to the corresponding input jack on your TV using a Video cable.

Component Video connection (B)

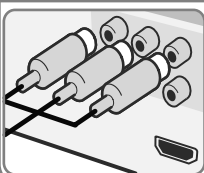

Connect the COMPONENT VIDEO (PROGRESSIVE SCAN) OUTPUT jacks on the unit to the corresponding input jacks on your TV using a Y PB PR cable.

HDMI Out connection (C)

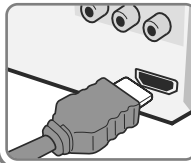

Connect the HDMI OUTPUT jack on the unit to the HDMI input jack on a HDMI compatible TV using a HDMI cable.

Available resolution according to connection

Displayed resolution in display window and outputted resolution may different according to connection type.

[HDMI OUT]: 1080p, 1080i, 720p and 480p (or 576p) and 480i (or 576i) **[COMPONENT VIDEO OUT]:** 480p (or 576p) and 480i (or 576i) **[VIDEO OUT]:** 480i (or 576i)

Notes on HDMI Out connection

- If your TV does not accept your resolution setting, abnormal picture appears on the screen. ("TV do not support" will appears in screen). Please read owner's manual for TV, and then set the resolution that your TV can accept.
- Changing the resolution when the unit is connected with HDMI connector may result in malfunctions. To solve the problem, turn off the unit and then turn it on again.
- When you connect a HDMI or DVI compatible device make sure of the following :
 - Try switching off the HDMI/ DVI device and this unit. Next, switch on the HDMI/ DVI device and leave it for around 30 seconds, then switch on this unit.
 - The connected device's video input is set correctly for this unit.
 - The connected device is compatible with 720X480i(576i), 720X480p(576p), 1280X720p, 1920X1080i or 1920X1080p video input.
 - The 1080p, 720p and 480p(576p) resolutions are the progressive scan applied resolution.
- Not all HDCP-compatible DVI devices will work with this unit.
 - The picture will not be displayed properly with non-HDCP device.

Enjoying audio from an external source and selecting the function

You can enjoy audio from an external source through your unit. And You can select the function. Press **FUNCTION** repeatedly to select the desired input source and the function (DVD/CD, USB, AUX, AUX OPT, PORTABLE, FM, AM).

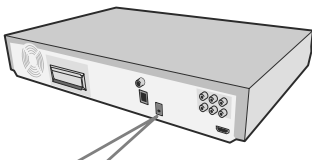

Digital Audio in connection

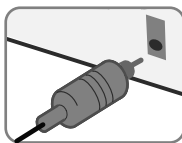

Connect the unit's OPTICAL IN jack to the optical out to jack on your TV (or Digital Device etc.)

Speaker Setting up

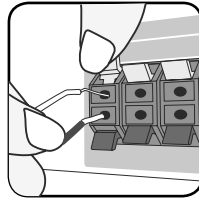

Attaching the speakers to the DVD receiver

1 You will have received six speaker cables.

Each one is colour - coded by a band near each end and connects one of the six speakers to the DVD receiver.

2 Connect the wires to the DVD receiver.

Match each wire's coloured band to the same coloured connection terminal on the rear of the DVD receiver. To connect the cable to the DVD receiver, press each plastic finger pad to open the connection terminal. Insert the wire and release the finger pad.

Connect the black end of each wire to the terminals marked -(minus) and the other end to the terminals marked + (plus).

3 Connect the wires to the speakers.

Connect the other end of each wire to the correct speaker according to the colour coding

Main Unit	SPEAKER	POSITION
REAR R	Grey	Behind you and to your right.
FRONT R	Red	In front of you, to the right of the screen.
CENTER	Green	Above screen, directly in front of you.
SUB WOOFER	Orange	This can be placed in any front position.
REAR L	Blue	Behind you and to your left.
FRONT L	White	In front of you, to the left of the screen.

To connect the cable to the speakers, press each plastic finger pad to open the connection terminals on the base of each speaker. Insert the wire and release the finger pad.

Be careful of the following

Be careful to make sure children do not put their hands or any objects into the speaker duct.

Speaker duct: A hall for plentiful bass sound on speaker cabinet(enclosure). Use the rear speaker at least 30 CM away from either TV screen or PC monitor.

Initial Settings

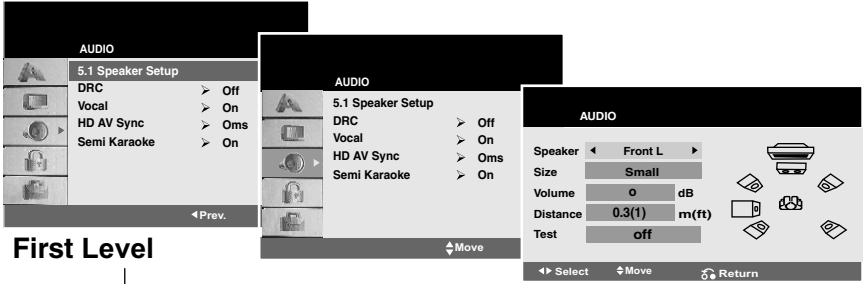

First Level

Second Level

Third Level

Initial Settings

By using the Setup menu, you can make various adjustments to items such as picture and sound. You can also set a language for the subtitles and the Setup menu, among other things. For details on each Setup menu item, see the pages 9 to 15.

To display and exit the Menu :

Press **SETUP** to display the menu. A second press of **SETUP** will take you back to initial screen.

To go to the next level :

Press **▶** on the remote control.

To go back to the previous level :

Press **◀** on the remote control.

General Operation

Adjust the settings	ON REMOTE
1 Display setup menu:	SETUP
2 Select a desired option on the first level:	▲▼
3 Move to second level:	▶
4 Select a desired option on the second level:	▲▼
5 Move to third level:	▶
6 Change the setting:	▲▼ / ENTER



A LANGUAGE

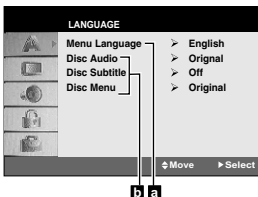

a Menu Language

Select a language for the Setup menu and then on-screen display.

b Disc Audio / Subtitle / Menu

Select the language you prefer for the audio track (disc audio), subtitles, and the disc menu.

Original - Refers to the original language in which the disc was recorded.

Other - To select another language, press numeric buttons and then **ENTER** to enter the corresponding 4-digit number according to the language code list on the page 23. If you enter the wrong language code, press **CLEAR**.

Disc Subtitle - Refer to the turn ON/OFF subtitle.

B DISPLAY

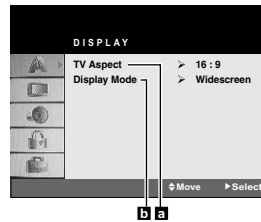

a TV Aspect

4:3 - Select when a standard 4:3 TV is connected.

16:9 - Select when a 16:9 wide TV is connected.

b Display Mode

The Display Mode setting works only when the TV Aspect mode is set to "4:3".

Letterbox - Displays a wide picture with black bands on the upper and lower portions of the screen.

Panscan - Automatically displays the wide picture on the entire screen and cuts off the portions that do not fit.

C AUDIO

Each DVD disc has a variety of audio output options. Set the player's AUDIO options according to the type of audio system you use.

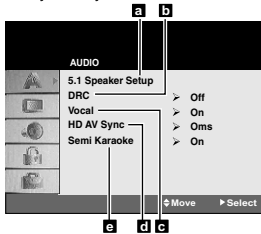

a Speaker Setup **DVD** **DivX**

5.1ch : Select 5.1ch speaker settings, including volume balance and distance, or test the speaker settings. Speaker settings are only active on the Analog Multi Channel Output.

5.1 Speaker Setup

	ON REMOTE
1 Open the settings menu:	SETUP
2 Select to the audio icon:	Λ V
3 Select right to enter the audio menu, then select 5.1 Speaker Setup:	> Λ V ENTER
4 Select the speaker you want to adjust:	< >
5 Select a option and change the settings:	Λ V < >
6 Set the output level (volume) of a speaker: from -5dB to +5dB. The speaker size setting are fixed, so you cannot change the setting.	< >
7 If you connect speakers to your unit, setting the Distance lets the speakers to know how far the sound has to travel to reach your set listening point. This allows the sound from each speaker to reach the listener at the same time.	< >
8 Test the signals of each speaker: Adjust the volume to your taste according to these signals.	< >
9 Save your settings and exit the Setup menu:	RETURN

b DRC (Dynamic Range Control) **DVD** **DivX**

With the DVD format, you can hear a program's soundtrack in the most accurate and realistic presentation. However, you may wish to compress the dynamic range of the audio output (the difference between the loudest sounds and the quietest ones). This allows you to listen to a movie at a lower volume without losing clarity of sound. Set DRC to On for this effect.

c Vocal **DVD**

Set to On only when a multi-channel karaoke DVD is playing. The karaoke channels on the disc mix into normal stereo sound.

d HD AV Sync - Sometimes Digital TV encounters a delay between picture and sound. If this happens you can compensate by setting a delay on the sound so that it effectively 'waits' for the picture to arrive: this is called HD AV Sync. Use Λ V (on the remote control) to scroll up and down through the delay amount, which you can set at anything between 0 and 300m sec.

e Semi Karaoke - When a chapter/ title/ track is fully finished, this function shows the score in the screen with a fanfare sound. Available discs for the Semi Karaoke function: DVD discs/ DVD Karaoke Discs

[On] : When you finished singing a score will appear on the screen.

[Off] : Fanfare and score do not appears on the screen.

- This function operate on the DVD/CD mode.

- The Semi Karaoke function is available only when a microphone is connected.

- In case that a fanfare or score appears when a chapter of a movie file is changed during playback, set the Semi Karaoke to "Off" at the setup menu or disconnect the microphone.

D LOCK(Parental Control)

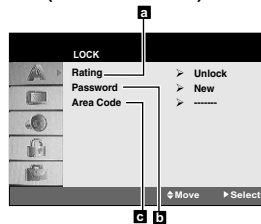

a Rating **DVD**

Blocks playback of rated DVDs based on their contents. Not all discs are rated.

1. Select "Rating" on the LOCK menu then press ▶.
2. To access the LOCK options, you must input the password you have created. If you have not yet entered password, you are prompted to do so. Input a password and press ENTER. Enter it again and press ENTER to verify. If you make a mistake before pressing ENTER, press CLEAR.
3. Select a rating from 1 to 8 using the ▲/▼ buttons.

Rating 1-8: Rating one (1) has the most restrictions and rating eight (8) is the least restrictive.

Continued on page No. 15

OSD Initial language settings

During the first use of this unit, the initial language setup menu appears on your TV screen. You must complete initial language selection before using the unit. English will be selected as the initial language.

	ON REMOTE
1 Turn the power on : The language list appears	POWER
2 Select the language :	▲ ▼ < >
3 Press :	ENTER
4 To confirm press :	< > and ENTER

Displaying Disc Information on-screen

Displaying Disc Information

	ON REMOTE
1 Press DISPLAY:	DISPLAY
2 Select a item:	▲
3 Adjust the Display menu settings:	◀ / ▶ / ENTER
4 To return the exit:	DISPLAY

Displaying Disc Information - more you can do

You can select an item by pressing pressing < >.

1/3 ▶ Current title (or track/ file) number/ total number of titles (or tracks/ files)	Playback Status/ Restrictions	Repeat title
4/25 ▶ Current chapter number/ total number of chapters	A - B	Repeat sequence
-1--1-- Elapsed playing time	1 / 9	Enter a Marker
1 ENG DE 1 3/2/CH Selected audio language or channel	MARKER SEARCH	Marker Search menu
1 KOR Selected subtitle	Resume play from this point	
1/3 Selected angle/ total number of angles	Action prohibited or not available	
NORMAL Selected sound mode		

Playing a Disc or file

	ON REMOTE
1 Insert a disc on unit :	▲ OPEN/CLOSE
2 Select a DVD/CD :	FUNCTION
3 Adjust the menu settings : or Select a file from the menu :	▲ ▼ < > ▲ ▼
4 Start the Disc playing :	▶ PLAY
5 To stop the Disc playing :	■ STOP

Example: On-Screen Display during playing DVD Video

Items	Selection Method
Title Number 1 / 3 ▶	◀ / ▶ Numbers ENTER
Chapter Number 1 / 12 ▶	◀ / ▶ Numbers ENTER
Time search 0:20:09	Numbers, ENTER
Audio language and Digital Audio Output mode 1 ENG DDD ▶ 3/2.1CH	◀ / ▶ or AUDIO
Subtitle language 1 ENG ▶	◀ / ▶ or SUBTITLE
Angle 1 / 3 ▶	◀ / ▶ or ANGLE

Example: On-Screen Display during playing VCD

Items	Selection Method
Track Number (or PBC mode) 1 / 3 ▶	◀ / ▶ Numbers ENTER
Time search 0:20:09	Numbers ENTER
Audio Channel Stereo ▶	◀ / ▶ or AUDIO

Example: On-Screen Display during playing divx movie disc*

Items	Selection Method
Track Number 1 / 3 ▶	◀ / ▶ Numbers ENTER
Time search 0:20:09	Numbers, ENTER
Audio language and Digital Audio Output mode 1 MP3 2/0 CH	◀ / ▶ or AUDIO
Subtitle language 1 ENG ▶	◀ / ▶ or SUBTITLE

Troubleshooting

Problem	Cause
No power	The power cord is disconnected.
No picture	The TV is not set to receive the DVD signal. The video cables are not connected securely.
There is little or no sound	Equipment connected via the audio cable is not set to receive DVD signal output. The audio cables are not connected to the speakers or receiver securely. The audio cables are damaged.
The DVD picture quality is poor	The disc is dirty.
A DVD/CD will not play	No disc is inserted. An unplayable disc is inserted. The disc is inserted upside down. The menu is open on screen. There is a parental lock which prevents the playback of DVDs with a certain rating.
Humming noise heard while a DVD or CD is playing	The disc is dirty. The DVD receiver is located too close to the TV, causing feedback.
Radio stations can't be tuned in properly	The antenna is positioned or connected poorly. The signal strength of the radio station is too weak. No stations have been preset or preset stations have been cleared (when tuning by scanning preset channels).
The remote control doesn't work well / at all	The remote is not pointed directly at the DVD receiver. The remote is too far from the DVD receiver. There is an obstacle in the path between the remote control and the unit. The batteries in the remote control are flat.

Operations

General features

Buttons	Operations	Discs
OPEN / CLOSE (▲)	Opens or closes the disc tray.	ALL
PAUSE/STEP ()	During playback, press to pause playback. Press repeatedly to play Frame-by-Frame.	ALL DVD VCD DivX
SKIP (I◀◀ / ▶▶I)	During playback, press SKIP (I◀◀ or ▶▶I) to go to the next chapter/track or to return to the beginning of the current chapter/track. Press SKIP I◀◀ twice briefly to step back to the previous chapter/track.	ALL
SCAN (◀◀ / ▶▶)	During playback, press SCAN (◀◀ or ▶▶) repeatedly to select the required scan speed. DVD, Divx disc: 5 steps, Video CD: 4 steps, MP3, WMA, Audio CD, 3 steps While the playback is paused, press SCAN (◀◀ or ▶▶) repeatedly to play in slow motion (4 steps).	ALL DVD VCD DivX (forward only)
REPEAT	During playback, press REPEAT repeatedly to select a desired repeat mode. DVD Video discs: Chapter/Title/Off Video CD, Audio CD, DivX/MP3/WMA discs: Track/All/Off	ALL
RETURN (↶)	Press to move backwards in the menu or exit the menu.	
TITLE	If the current DVD title has a menu, the title menu appears on the screen. Otherwise, the disc menu may appear.	DVD
DVD MENU	The disc menu appears on the screen.	DVD
(SUBTITLE)	During playback, press SUBTITLE repeatedly to select a desired subtitle language.	DVD DivX
REC.	Press this key to record directly in USB.	
FUNC.	Press to change/select the function and input source.	
RESOLUTION	Press this key change/select output resolution.	
TV→HTSPK	Press this key select the AUX output directly.	
NIGHT	Press this key to listen improved sound at lower volumes.	

Correction

- Plug the power cord into the wall outlet securely.
- Select the appropriate video input mode on the TV so the picture from the DVD Receiver appears on the TV screen.
- Connect the video cables securely to both the TV and DVD Receiver.
- Select the correct input mode of the audio receiver so you can hear the sound from the DVD receiver.
- Connect the audio cables into the connection terminals correctly.
- Replace with a new audio cable.
- Clean the disc using a soft cloth with outward strokes.
- Insert a disc
- Insert a playable disc (check the disc type, colour system and regional code).
- Place the disc with the label or printed side facing upwards.
- Press **SETUP** to close the menu screen.
- Enter your password or change the rating level.
- Clean the disc using a soft cloth with outward strokes.
- Move DVD receiver and audio components further away from your TV.
- Check the antenna connection and adjust its position.
- Attach an external aerial if necessary.
- Tune to the station manually.
- Preset some radio stations, see page 20 for details.
- Point the remote directly at the unit.
- Use the remote within 23 feet (7m) of the DVD receiver.
- Remove the obstacle.
- Replace the batteries with new ones.

Unlock

If you select unlock, parental control is not active and the disc plays in full.

Notes:

If you set a rating for the player, all disc scenes with the same rating or lower are played. Higher rated scenes are not played unless an alternate scene is available on the disc. The alternative must have the same rating or a lower one. If no suitable alternative is found, playback stops. You must enter the 4-digit password or change the rating level in order to play the disc.

4. Press ENTER to confirm your rating selection, then press SETUP to exit the menu.

B Password

You can enter or change password.

1. Select Password on the LOCK menu and then press ►.
2. To make a new password: Press ENTER when the "New" option is highlighted. Enter a new four digit password using the numerical buttons then press ENTER. Enter the password again to verify.

To change the password:

Press ENTER when the "Change" option is highlighted. Enter a current password using the numbered buttons then press ENTER. Enter a new password using the numbered buttons then press ENTER. Enter the password again to verify.

3. Press SETUP to exit the menu.

If you forget your password

If you forget your password, you can clear it using the following steps:

1. Press SETUP to display the Setup menu.
2. Input the 6-digit number "210499" and the security code is cleared.

A Area Code

Enter the code of the area whose standards were used to rate the DVD video disc, based on the list on page 23.

1. Select "Area Code" on the LOCK menu then press ►.
2. Follow the step 2 as shown on page No 10 (Rating).
3. Select the first character using ▼/▲ buttons.
4. Press ENTER and select the second character using ▼/▲ buttons.
5. Press ENTER to confirm your Area code selection.

E OTHERS

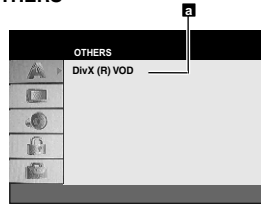

a DivX(R) VOD **DivX**

We provide you the DivX® VOD (Video On Demand) registration code that allows you to rent and purchase videos based on the DivX® VOD service. For more information, visit www.divx.com/vod.

1. Select "DivX(R) VOD" option and then press ►.
2. Press ENTER while "Select" is selected and the registration code will appear. Use the registration code to purchase or rent the videos from DivX® VOD service at www.divx.com/vod. Follow the instructions and download the video onto a disc for playback on this unit.
3. Press ENTER to exit.



The Registration code is used for VOD (Video-On-Demand) service agent. You can purchase or rent an encrypted movie file.

Notes:

If you rent the DivX VOD file, it has several options of viewing limits as shown below.

- Display the number which you can watch the file.

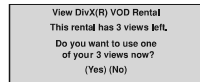

- The rental has been expired.
- Display the authorization error.

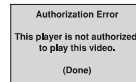
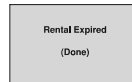

Rec bitrate:

Enjoying a pre-programmed sound field

This system has a number of pre-set surround sound fields. You can select a desired sound mode by using **SPECIAL EQ/ NIGHT**. You can change the **SPECIAL EQ/ NIGHT** using < > arrow key while the **SPECIAL EQ/ NIGHT** information is displayed on.

The displayed items for the Equalizer may be different depending on sound sources and effects.

ON DISPLAY	Description
BASE EQ / INDIA EQ	Indian Music Optimised sound effect.
AUTO EQ	Realizes the sound equalizer that is the most similar to the genre of which is included in the MP3 ID3 tag of song files.
POP / CLASSIC JAZZ / ROCK	This program lends an enthusiastic atmosphere to the sound, giving you the feeling you are at an actual rock pop, jazz or classic concert.
MP3 OPT	This function is optimized for compressible MP3, WMA file. It improves the bass sound.
BASS	Reinforce the treble, bass and surround sound effect.
CLEAR VOICE	This program make Voice sound clear, improving the quality of voice sound. (We encourage to use this EQ when you watch the movie of 5.1 channel.)
GAME EQ	You can enjoy more virtual sound while playing video games.
NIGHT MODE	This may be useful when you want to watch movies at low volumes late at night.
CINEMA MODE	You can enjoy more virtual sound while watching movies.
VIRTUAL	You can enjoy more virtual surround sound.
PLII MOVIE PLII MUSIC PLII MTRX(matrix)	Dolby Pro Logic II enables you to play stereo source (i.e. 2 Channel Sources) into 5-channel. (We encourage a person to use the PLII MTRX.)
NORMAL(OFF)	You can enjoy the sound without equalizer effect

Note : Auto EQ and MP3 OPT works only with MP3 / WMA disc only.

Other operations

Fall asleep while listening to your player

Press **SLEEP** one or more times to select delay time between 10 and 180 minutes, after the player will turn off.

To check the remaining time, press **SLEEP**. To cancel the sleep function, press **SLEEP** repeatedly until "SLEEP 10" appears, and then press **SLEEP** once again while "SLEEP 10" is displayed.

DIMMER

Press **SLEEP** once. The LED (Light-emitting diode) of front panel is turned off and the display window will be darken by half. To cancel it, press **SLEEP** repeatedly until dim off.

Screen Saver

The screen saver appears when you leave the unit in Stop mode for about five minutes.

System Select

You must select the appropriate system mode for your TV system. If "NO DISC" appears in the display window, press and hold **PAUSE/STEP (II)** on the remote control for more than five seconds to be able to select a system. (PAL/NTSC).

VOCAL FADER

You can enjoy the function as karaoke, by reducing singer vocal of music in the various source. (MP3 / WMA / CD) Press the **VOCAL FADER**, and "FADE ON" will appear in display window.

- To cancel it, press **VOCAL FADER** again.

- The quality of the **VOCAL FADER** may be different depending on the recording conditions of music files.

- It is not available on the MONO source.

Playing a Disc or file - more you can do

Playing a DVD that has a menu **DVD**

Most DVDs now have menus which load first before the film begins to play. You can navigate these menus using \wedge \vee $<$ $>$ to highlight an option. Press **PLAY** (\blacktriangleright) to select.

Skipping to the next/ previous chapter/ track/ file **ALL**

Press **SKIP** ($\blacktriangleright\blacktriangleright$) to move to the next chapter/ track/ file.

Press **SKIP** ($\blacktriangleleft\blacktriangleleft$) to return to the beginning of the current chapter/ track/ file.

Press **SKIP** ($\blacktriangleleft\blacktriangleleft$) twice briefly to step back to the previous chapter/ track/ file.

Pausing playback **ALL**

Press **PAUSE/STEP** (\parallel) to pause playback. Press **PLAY** (\blacktriangleright) to continue playback.

Frame-by-Frame playback **DVD** **DivX**

Press **PAUSE/STEP** (\parallel) repeatedly to play title Frame-by-Frame.

Playing repeatedly or randomly **ALL**

Press **REPEAT/RANDOM** repeatedly, and the current title, chapter or track will be played back repeatedly or randomly. To return to normal playback, press

REPEAT/RANDOM repeatedly.

- Random play mode : only music files.

Fast forward or fast reverse **ALL**

Press **SCAN** ($\blacktriangleleft\blacktriangleleft$ or $\blacktriangleright\blacktriangleright$) to play fast forward or fast reverse during playback. You can change the playback speed by pressing **SCAN** ($\blacktriangleleft\blacktriangleleft$ or $\blacktriangleright\blacktriangleright$) repeatedly. Press **PLAY** (\blacktriangleright) to continue play at normal speed.

Selecting a subtitle language **DVD** **DivX**

During playback, press **SUBTITLE** (\square) repeatedly to select a desired subtitle language.

Slow down the playing speed **DVD** **DivX**

While playback is paused, press **SCAN** ($\blacktriangleleft\blacktriangleleft$ or $\blacktriangleright\blacktriangleright$) to slow down forward or reverse playback. You can change the various playback speed by pressing **SCAN** ($\blacktriangleleft\blacktriangleleft$ or $\blacktriangleright\blacktriangleright$) repeatedly. Press **PLAY** (\blacktriangleright) to continue play at normal speed. The DivX file cannot be slow down reverse playback.

1.5 times faster playback **DVD**

Press **PLAY** (\blacktriangleright) when a DVD is already playing to watch and listen to a DVD 1.5 times faster than normal playback speed. " \blacktriangleright x1.5" will appear in the screen. Press **PLAY** (\blacktriangleright) again to return to normal playback speed.

If you insert the microphone during "x1.5" speed playback, it returns to the normal play mode.

This function is not operated when you cannot the microphone.

Viewing the Title menu **DVD**

Press **TITLE** to display the disc's title menu, if available.

Starting play from selected time **DVD** **DivX**

Searches for the starting point of entered time code. Press **DISPLAY** then select clock icon. Enter a time then press **ENTER**. For example, to find a scene at 1 hour, 10 minutes, and 20 seconds, enter "11020" by using numerical buttons and press **ENTER**. If you enter the wrong number, press **CLEAR** to enter again.

Last Scene Memory **DVD**

This unit memorizes the last scene from the last disc that is viewed. The last scene remains in memory even if you remove the disc from the player or switch off (Stand-by mode) the unit. If you load a disc that has the scene memorized, the scene is automatically recalled.

Mixed disc or USB Flash Drive – DivX, MP3/ WMA and JPEG

When playing a disc or USB Flash Drive containing with DivX, MP3/ WMA and JPEG together, you can select menu of files which you would like to play by pressing **MENU**. "This file has non-supported type" pops up, select and appropriate file by pressing **MEI**

Viewing the DVD MENU **(DVD)**

Press **MENU** to display the disc menu, if available.

Changing the character set to display DivX® subtitle correctly **(DivX)**

If the subtitle does not display properly during playback, press and hold **SUBTITLE** for seconds then press **< >** or **SUBTITLE** to select another language code until the subtitle displayed properly and then press **ENTER**.

DivX file requirement **(DivX)**

DivX disc compatibility with this player is limited as follows :

- Available resolution: within 720x576 (W x H) pixels
- The file name of the DivX subtitle should be entered within 45 characters.
- If there is impossible code to express in the DivX file, it may be displayed as " _ " mark on the display.
- Frame rate : less than 30 fps
- If the video and audio structure of recorded files is not interleaved, either video or audio outputted.
- Playable DivX file : ".avi", ".mpg", ".mpeg", ".divx"
- Playable Subtitle format : SubRip (*.srt/ *.txt), SAMI (*.smi), SubStation Alpha (*.sub/ *.txt), SubViewer 2.0 (*.sub/ *.txt) (*.ssa/ *.txt), MicroDVD
- Playable Codec format : "DIVX3.xx", "DIVX4.xx", "DIVX5.xx", "MP4V3", "3IVX".
- Playable Audio format : "AC3", "DTS", "PCM", "MP3", "WMA".
- Sampling frequency : within 32 - 48 kHz (MP3), within 32 - 48kHz (WMA)
- Bit rate: within 32 - 320kbps (MP3), 40 - 192kbps (WMA)
- For Discs formatted in Live file system, you can not it on this player.
- If the name of movie file is different from that of the subtitle file, during playback of subtitle may not be display.
- If you play a DivX file differ from DivX spec, it may not operate normally.

Creating your own program **(ACD) (MP3) (WMA)**

You can play the contents of a disc in the order you want by arranging the order of the disc. To add a music(s) on the program list, press.

PROG/MEMO to enter the program edit mode (Ⓢ mark appears on the menu). Select music on the [List] by using the **▲ ▼** then press **ENTER** to add the music to the program music from the program list then press **ENTER** to start programmed playback. To clear music from the program list, select the music you want to clear by using the **▲ ▼** then press **C** program edit mode. To clear all music from the program list, select [Clear All] then press program edit mode. The program is cleared when the disc is removed or the unit is turned off.

Displaying file information (ID3 TAG) **(MP3)**

While playing an MP3/ WMA file containing file information, you can display the information by pressing **DISPLAY** repeatedly.



MP3/ WMA music file requirement

MP3/ WMA disc compatibility with this player is limited as follows :

- Sampling frequency : within 32 - 48 kHz (MP3), within 32 - 48kHz (WMA)
- Bit rate : within 32 - 320kbps (MP3), 40 - 192kbps (WMA)
- Support Version : v2, v7, v8, v9
- Maximum files : Under 999.
- File extensions : ".mp3"/ ".wma"
- CD-ROM file format : ISO9660/ JOLIET
- We recommend that you use Easy-CD Creator, which creates an ISO 9660 file system.

Viewing photo files - more you can do

Viewing photo files as a slide show

Use **Λ V < >** to highlight () icon then press **PLAY (▶)** to start slide Show. You can change slide show speed using **< >** when () icon is highlighted. Depending on the size and resolution of JPEG files, it may take longer for slide show to be set.

Skipping to the next/ previous photo

Press **SKIP (◀◀ or ▶▶)** or **< >** to view the previous/ next photo.

Rotating a photo

Use **Λ V** to rotate the photo in full screen counterclockwise or clockwise while viewing a photo in full screen.

Pausing a slide show

Press **PAUSE/STEP (||)** to pause a slide show. Press **PLAY (▶)** or **PAUSE/STEP (||)** to continue the slide show.

Listening to music during slide show

You can listen to music during slide show, if the disc contain music and photo files together. Use **Λ V < >** to highlight () icon then press **PLAY (▶)** to start slide show. This function is available only in disc.

Note : This feature is not available with USB.

Photo file requirement

JPEG disc compatibility with this player is limited as follows :

- Max pixel in width : 2760 x 2048 pixel
- Maximum files : Under 999.
- Some discs may not operate due to a different recording format or the condition of disc.
- File extensions: “.jpg”
- CD-ROM file format : ISO9660/ JOLIET

Viewing photo files

	ON REMOTE
1 Insert a disc on unit :	▲ OPEN/CLOSE
2 Select a DVD/CD :	FUNCTION
3 Select a photo file :	Λ V
4 Display the selected file in full screen :	▶ PLAY
5 To return to the menu :	■ STOP

Listening to music from your portable player or external device

The unit can be used to play the music from many types of portable player or external device.

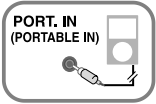
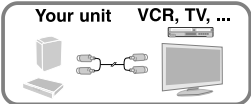
	ON REMOTE
<p>1 Connect the portable player to the PORT.IN (PORTABLE IN) connector of the unit.</p> <p style="text-align: center;">Or</p> <p>Connect the external device to the AUX connector of the unit. > If your TV has only one output for audio(MONO), connect it to the left(white) audio jack on the unit.</p> <div style="display: flex; justify-content: space-around; align-items: center;"> <div style="text-align: center;">  <p>PORT. IN (PORTABLE IN)</p> </div> <div style="text-align: center;">  <p>Your unit VCR, TV, ...</p> </div> </div>	-
2 Turn the power on	POWER
3 Select the PORTABLE or AUX function	FUNCTION
4 Turn the portable external device and start it playing	-

Listening to the radio

Be sure that both FM and AM aerials are connected.

	ON REMOTE
1 Turn the power on :	POWER
2 Select either FM or AM :	FUNCTION
3 Select a radio station :	TUN.-/+
4 To 'save' a radio station : A preset number will show in the display.	PROG/MEMO.
5 Select the preset number : Up to 50 radio stations can be saved.	PRESET ^ V
6 To confirm press :	PROG/MEMO.
7 To select a 'saved' station input the preset number :	PRESET ^ V

Listening to the radio - more you can do

Looking for radio stations automatically

Press and hold **TUN.-/ TUN.+** for more than a second. The tuner will scan automatically and stop when it finds a radio station.

Deleting all the saved stations

Press and hold **PROG./MEMO.** for two seconds. ERASE ALL will flash up on the DVD receiver display. Press **PROG./MEMO.** to erase all saved radio stations.

Improving poor FM reception

Press **PLAY (▶) (MONO/ST)** on the remote control. This will change the tuner

Home theater Speaker ez Set-up

Listen to sound from TV, DVD and Digital Device with 5.1(2.1 or 2)ch mode. Even in power off mode, if you press **TV→HT SPK**, then power is on and automatically changed to AUX OPT mode.

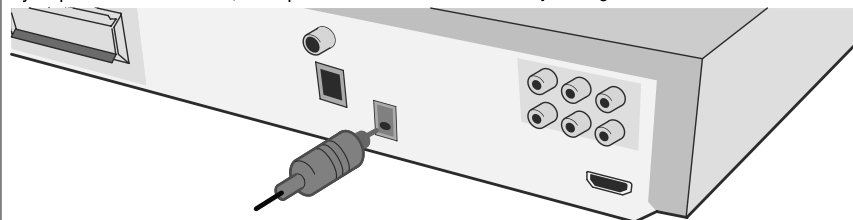

	ON REMOTE
1 Connect the unit's OPTICAL IN jack to jack on optical out of your TV (or Digital Device etc.):	-
2 Select the AUX OPT: To select the AUX OPT directly	TV→HT SPK
3 Listen sound with 5.1(2.1 or 2)ch speaker.:	-
4 To escape from AUX OPT: Function is returned to previous one.	TV→HT SPK

Using an USB device

You can enjoy media files saved on an USB device by connecting the USB device to the USB port of the unit. If you want to operate other function, see the CD playback section.

	ON REMOTE
1 Connect the USB device to the USB port of the unit.	-
2. Select the USB function	FUNCTION
3 Select a file you want to play	∧ ∨
4 Start your media playing	▶ PLAY
5 To stop, press	■ STOP
6 Before disconnecting the portable USB device, change to any other function.	FUNCTION

Compatible USB Devices

- MP3 Player : Flash type MP3 player.
- USB Flash Drive : Devices that support USB2.0 or USB1.1.
- The USB function of this unit does not support all USB devices.

USB device requirement

- Devices which require additional program installation when you have connected it to a computer, are not supported.

Look out for the follows.

- **Do not extract the USB device while in operation.**
- For a large capacity USB, it may take longer than a few minute to be searched
- To prevent data loss, back up all data.
- If you use a USB extension cable or USB hub, the USB device is not recognized.
- Using NTFS file system is not supported. (Only FAT(16/32) file system is supported.
- This unit is not supported when the total number of files is 1000 or more.
- External HDD, Card readers, Locked devices, or hard type usb devices are not supported.
- USB port of the unit cannot be connected to PC. The unit can not be used as a storage device.

Recording to USB - more you can do

Recording Music file in disc source to USB

One track recording

If the USB recording is played during playback of the CD, the one track/ file would be recording into the USB.

Recording to USB

	ON REMOTE
1 Connect the USB device to the unit	-
2 Select a mode in which you want to record (ex. CD/ TUNER....) Play back a sound source first If you want to record desired music file in Disc to USB, record after playing back the file.	FUNCTION ∧ ∨ and ▶ PLAY
3 Start the recording	● REC
4 To stop recording, press	■ STOP

All tracks recording

If the recording button is pressed at the CD stop, all tracks/ files would be recording.



- The files in the sub-folders are not recorded during all track recording.
- If you want to all tracks recording during playback, press stop twice. check the “■” on the screen.

Program list recording

USB records after creating your own program if you want to record the track you want (AUDIO CD Only).

When you are recording, look out for the following

- You can check the recording percentage rate for the USB record on the screen during the recording.(AUDIO CD or MP3/ WMA CD only)
- During recording MP3/ WMA, there is no sound.
- When you stop recording during playback, the file that has been recorded at that time will be stored.(AUDIO CD Only)
- Do not remove the USB device during USB recording. If not, an incomplete file may be made and not deleted on PC.
- Recording through microphones is not available.
- If USB recording does not work, the message like “NO USB”, “ERROR”, “USB FULL” or “NO REC” is displayed on the display window.
- Multi card reader device or external HDD can not be used for USB recording.
- A file is recorded by 128Mbyte (about 2 hours) when you record for a long term. There are recorded less than 4 files.
- When you stop recording during playback, the file will not be stored.
- In the state CD-G, DTS disc USB record is not operated
- You may not record more than 999 files.
- **It'll be stored as follows.**

AUDIO CD	MP3/ WMA	The other sources (Tuner, AUX, Portable)
 CD_REC ├── TRK_001 ├── TRK_002 ├── ⋮ └──	 FILE_REC ├── 001_ABC(File name) ├── 002_DEF(File name) ├── ⋮ └──	 EXT_REC ├── AUDIO_001 ├── AUDIO_002 ├── ⋮ └──

The making of unauthorized copies of copy-protected material, including computer programs, files, broadcasts and sound recordings, may be an infringement of copyrights and constitute a criminal offense. This equipment should not be used for such purposes.

Be responsible
Respect copyrights

Use this list to input your desired language for the following initial settings: Disc Audio, Disc Subtitle, Disc Menu.

Language	Code	Language	Code	Language	Code	Language	Code	Language	Code		
Afar	6565	Croatian	7282	Hausa	7265	Lingala	7678	Quechua	8185	Tajik	8471
Afrikaans	6570	Czech	6783	Hebrew	7387	Lithuanian	7684	Rhaeto-Romance	8277	Tamil	8465
Albanian	8381	Danish	6865	Hindi	7273	Macedonian	7775	Rumanian	8279	Telugu	8469
Ameharic	6577	Dutch	7876	Hungarian	7285	Malagasy	7771	Russian	8285	Thai	8472
Arabic	6582	English	6978	Icelandic	7383	Malay	7783	Samoan	8377	Tonga	8479
Armenian	7289	Esperanto	6979	Indonesian	7378	Malayalam	7776	Sanskrit	8365	Turkish	8482
Assamese	6583	Estonian	6984	Interlingua	7365	Maori	7773	Scots Gaelic	7168	Turkmen	8475
Aymara	6588	Farosee	7079	Irish	7165	Marathi	7782	Serbian	8382	Twi	8487
Azerbaijani	6590	Fiji	7074	Italian	7384	Moldavian	7779	Serbo-Croatian	8372	Ukrainian	8575
Bashkir	6665	Finnish	7073	Javanese	7487	Mongolian	7778	Shona	8378	Urdu	8582
Basque	6985	French	7082	Kannada	7578	Nauru	7865	Slovak	8368	Uzbek	8590
Bengali, Bangla	6678	Frisian	7089	Kashmiri	7583	Nepali	7869	Singhalese	8373	Vietnamese	8673
Bhutani	6890	Galician	7178	Kazakh	7575	Norwegian	7879	Slovak	8375	Volapük	8679
Bihari	6672	Georgian	7565	Kirghiz	7589	Oriya	7982	Slovenian	8376	Welsh	6789
Breton	6682	German	6869	Korean	7579	Panjabi	8065	Spanish	6983	Wolof	8779
Bulgarian	6671	Greek	6976	Kurdish	7585	Pashito, Pushto	8083	Sudanese	8365	Xhosa	8872
Burmese	7789	Greenlandic	7576	Laotian	7679	Persian	7065	Swahili	8387	Yiddish	7473
Byelorussian	6669	Guarani	7178	Latin	7665	Polish	8076	Swedish	8386	Yoruba	8879
Chinese	9072	Gujarati	7185	Latvian, Lettish	7686	Portuguese	8084	Tagalog	8476	Zulu	9085

Choose a area code from this list.

Area	Code	Area	Code	Area	Code	Area	Code	Area	Code		
Alghanistan	AF	Costa Rica	CR	Greenland	GL	Maldives	MV	Paraguay	PY	Sri Lanka	LK
Argentina	AR	Croatia	HR	Hong Kong	HK	Mexico	MX	Philippines	PH	Sweden	SE
Australia	AU	Czech Republic	CZ	Hungary	HU	Monaco	MC	Poland	PL	Switzerland	CH
Austria	AT	Denmark	DK	India	IN	Mongolia	MN	Portugal	PT	Taiwan	TW
Belgium	BE	Ecuador	EC	Indonesia	ID	Morocco	MA	Romania	RO	Thailand	TH
Bhutan	BT	Egypt	EG	Israel	IL	Nepal	NP	Russian Federation	RU	Turkey	TR
Bolivia	BO	El Salvador	SV	Italy	IT	Netherlands	NL	Saudi Arabia	SA	Uganda	UG
Brazil	BR	Ethiopia	ET	Jamaica	JM	Netherlands Antilles	AN	Senegal	SN	Ukraine	UA
Cambodia	KH	Fiji	FJ	Japan	JP	New Zealand	NZ	Singapore	SG	United States	US
Canada	CA	Finland	FI	Kenya	KE	Nigeria	NG	Slovak Republic	SK	Uruguay	UY
Chile	CL	France	FR	Kuwait	KW	Norway	NO	Slovenia	SI	Uzbekistan	UZ
China	CN	Germany	DE	Libya	LY	Oman	OM	South Africa	ZA	Vietnam	VN
Colombia	CO	Great Britain	GB	Luxembourg	LU	Pakistan	PK	South Korea	KR	Zimbabwe	ZW
Congo	CG	Greece	GR	Malaysia	MY	Panama	PA	Spain	ES		

General

Power Supply	Refer to main supply
Power consumption	Refer to main supply
External dimensions (W x H x D)	430 x 73 x 305 mm
Net Weight (Approx.)	3.9 kg
Operating temperature:	5 °C to 35 °C
Operating humidity	5 % to 90 %
Laser	Semiconductor laser, Wavelength 650nm

Tuner FM & AM

FM Tuning Range	87.5 - 108.0 MHz
FM Intermediate Frequency	128 kHz
AM Tuning Range	522-1,620 kHz, 520-1,710 kHz or 522-1,710kHz
AM Intermediate Frequency	45 kHz

Amplifier

	HT924SF	HT855PF
Stereo mode	175 W + 175 W (4W at 1 kHz, THD 10%)	136 W + 136 W (4W at 1 kHz, THD 10%)
Surround mode	175 W + 175 W (THD 10%)	136 W + 136 W (THD 10%)
Center*	175 W	136 W
Surround*	175 W + 175 W (4W at 1 kHz, THD 10%)	136 W + 136 W (4W at 1 kHz, THD 10%)
Subwoofer*	325 W (3W at 30 Hz, THD 10%)	170 W (3W at 30 Hz, THD 10%)

Speaker

	Front/Rear Speaker		Center Speaker		Passive Woofer	
Model	HT924SF	HT855PF	HT924SF	HT855PF	HT924SF	HT855PF
Impedance	4 Ω	4 Ω	4 Ω	4 Ω	3 Ω	3 Ω
Rated Input Power	175 W	136 W	175 W	136 W	325 W	170 W
Max. Input Power	310 W	272 W	310 W	272 W	450 W	340 W
Net Dimensions (WxHxD)	96x240x108 mm	200x573x200 mm 125x245x125 mm	350x105x93 mm	310x90x75 mm	216x405x310 mm	216x405x310 mm
Net Weight	0.8 kg	1.3 kg 0.6 kg	0.9 kg	1.0 kg	5.42 kg	5.42 kg
Type	1 Way 1 Speaker	2 Way 3 Speaker	1 Way 1 Speaker	2 Way 3 Speaker	1 Way 1 Speaker	1 Way 1 Speaker



Free Manuals Download Website

<http://myh66.com>

<http://usermanuals.us>

<http://www.somanuals.com>

<http://www.4manuals.cc>

<http://www.manual-lib.com>

<http://www.404manual.com>

<http://www.luxmanual.com>

<http://aubethermostatmanual.com>

Golf course search by state

<http://golfingnear.com>

Email search by domain

<http://emailbydomain.com>

Auto manuals search

<http://auto.somanuals.com>

TV manuals search

<http://tv.somanuals.com>