



DLP Projection TV OWNER'S MANUAL

**MODELS : RU-44SZ51D
RU-52SZ51D**

Please read this manual carefully before operating your set.
Retain it for future reference.
Record model number and serial number of the set.
See the label attached on the back cover and quote this
information to your dealer when you require service.

LG Electronics U.S.A., Inc.

**WARNING:**

TO REDUCE THE RISK OF ELECTRIC SHOCK DO NOT REMOVE COVER (OR BACK). NO USER SERVICEABLE PARTS INSIDE. REFER TO QUALIFIED SERVICE PERSONNEL.



The lightning flash with arrowhead symbol, within an equilateral triangle, is intended to alert the user to the presence of uninsulated "dangerous voltage" within the product's enclosure that may be of sufficient magnitude to constitute a risk of electric shock to persons.



The exclamation point within an equilateral triangle is intended to alert the user to the presence of important operating and maintenance (servicing) instructions in the literature accompanying the appliance.

WARNING:

TO PREVENT FIRE OR SHOCK HAZARDS, DO NOT EXPOSE THIS PRODUCT TO RAIN OR MOISTURE.

POWER CORD POLARIZATION:

CAUTION: TO PREVENT ELECTRIC SHOCK, MATCH WIDE BLADE OF PLUG TO WIDE SLOT, FULLY INSERT.

ATTENTION: POUR ÉVITER LES CHOCS ÉLECTRIQUES, INTRODUIRE LA LAME LA PLUS LARGE DE LA FICHE DANS LA BORNE CORRESPONDANTE DE LA PRISE ET POUSSER JUSQU'AU FOND.

NOTE TO CABLE/TV INSTALLER:

This reminder is provided to call the CATV system installer's attention to Article 820-40 of the National Electric Code (U.S.A.). The code provides guidelines for proper grounding and, in particular, specifies that the cable ground shall be connected to the grounding system of the building, as close to the point of the cable entry as practical.

REGULATORY INFORMATION:

This equipment has been tested and found to comply with the limits for a Class B digital device, pursuant to Part 15 of the FCC Rules. These limits are designed to provide reasonable protection against harmful interference when the equipment is operated in a residential installation. This equipment generates, uses and can radiate radio frequency energy and, if not installed and used in accordance with the instruction manual, may cause harmful interference to radio communications. However, there is no guarantee that interference will not occur in a particular installation. If this equipment does cause harmful interference to radio or television reception, which can be determined by turning the equipment off and on, the user is encouraged to try to correct the interference by one or more of the following measures:

- Reorient or relocate the receiving antenna.
- Increase the separation between the equipment and receiver.
- Connect the equipment into an outlet on a circuit different from that to which the receiver is connected.
- Consult the dealer or an experienced radio/TV technician for help.

Any changes or modifications not expressly approved by the party responsible for compliance could void the user's authority to operate the equipment.

CAUTION:

Do not attempt to modify this product in any way without written authorization from LG Electronics Corporation. Unauthorized modification could void the user's authority to operate this product.

COMPLIANCE:

The responsible party for this product's compliance is:
LG Electronics U.S.A., Inc
1000 Sylvan Avenue, Englewood Cliffs, NJ 07632
1-201-816-2000
<http://www.lgusa.com>

IMPORTANT SAFETY INSTRUCTIONS

Important safeguards for you and your new product

Your product has been manufactured and tested with your safety in mind. However, improper use can result in electrical shock or fire hazards. To avoid defeating the safeguards that have been built into your new product, please read and observe the following safety points when installing and using your new product, and save them for future reference.

Observing the simple precautions discussed in this manual can help you get many years of enjoyment and safe operation that are built into your new product.

This product complies with all applicable U.S. Federal safety requirements, and those of the Canadian Standards Association.

1. Read Instructions

All the safety and operating instructions should be read before the product is operated.

2. Follow Instructions

All operating and use instructions should be followed.

3. Retain Instructions

The safety and operating instructions should be retained for future reference.

4. Heed Warnings

All warnings on the product and in the operating instructions should be adhered to.

5. Cleaning

Unplug this product from the wall outlet before cleaning. Do not use liquid cleaners or aerosol cleaners. Use a damp cloth for cleaning.

6. Water and Moisture

Do not use this product near water, for example, near a bath tub, wash bowl, kitchen sink, or laundry tub, in a wet basement, or near a swimming pool.

7. Accessories, Carts, and Stands

Do not place this product on a slippery or tilted surface, or on an unstable cart, stand, tripod, bracket, or table. The product may slide or fall, causing serious injury to a child or adult, and serious damage to the product. Use only with a cart, stand, tripod, bracket, or table recommended by the manufacturer, or sold with the product. Any mounting of the product should follow the manufacturer's instructions, and should use a mounting accessory recommended by the manufacturer.

8. Transporting Product

A product and cart combination should be moved with care. Quick stops, excessive force, and uneven surfaces may cause the product and cart combination to overturn.



PORTABLE CART WARNING

9. Attachments

Do not use attachments not recommended by the product manufacturer as they may cause hazards.

10. Ventilation

Slots and openings in the cabinet are provided for ventilation and to ensure reliable operation of the product and to protect it from overheating, and these openings must not be blocked or covered. The openings should never be blocked by placing the product on a bed, sofa, rug, or other similar surface. This product should not be placed in a built-in installation such as a bookcase or rack unless proper ventilation is provided or the manufacturer's instructions have been adhered to.

11. Power Sources

This product should be operated only from the type of power source indicated on the marking label. If you are not sure of the type of power supply to your home, consult your product dealer or local power company. For products intended to operate from battery power, or other sources, refer to the operating instructions.

12. Power-Cord Polarization

This product is equipped with a polarized alternating-current line plug (a plug having one blade wider than the other). This plug will fit into the power outlet only one way. This is a safety feature. If you are unable to insert the plug fully into the outlet, try reversing the plug. If the plug should still fail to fit, contact your electrician to replace your obsolete outlet. Do not defeat the safety purpose of the polarized plug.

13. Power-Cord Protection

Power-supply cords should be routed so that they are not likely to be walked on or pinched by items placed upon or against them, paying particular attention to cords at plugs, convenience receptacles, and the point where they exit from the product.

(Continued on next page)

IMPORTANT SAFETY INSTRUCTIONS

(Continued from previous page)

14. Outdoor Antenna Grounding

If an outside antenna or cable system is connected to the product, be sure the antenna or cable system is grounded to provide protection against voltage surges and built-up static charges. Article 810 of the National Electrical Code (U.S.A.), ANSI/ NFPA 70 provides information with regard to proper grounding of the mast and supporting structure, grounding of the lead-in wire to an antenna discharge unit, size of grounding conductors, location of antenna-discharge unit, connection to grounding electrodes, and requirements for the grounding electrode.

Example of Grounding According to National Electrical Code Instructions

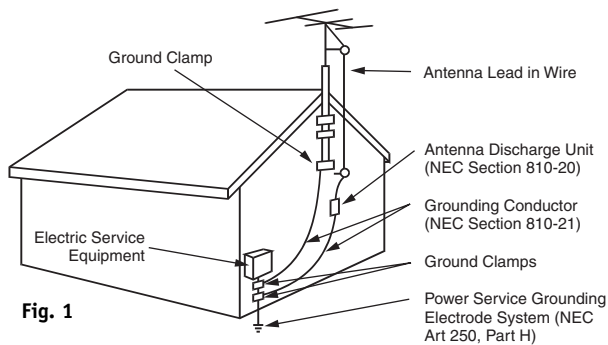

15. Lightning

For added protection for this product (receiver) during a lightning storm, or when it is left unattended and unused for long periods of time, unplug it from the wall outlet and disconnect the antenna or cable system. This will prevent damage to the product due to lightning and power-line surges.

16. Power Lines

An outside antenna system should not be located in the vicinity of overhead power lines or other electric light or power circuits, or where it can fall into such power lines or circuits. When installing an outside antenna system, extreme care should be taken to keep from touching such power lines or circuits as contact with them might be fatal.

17. Overloading

Do not overload wall outlets and extension cords as this can result in a risk of fire or electric shock.

18. Object and Liquid Entry

Never push objects of any kind into this product through

openings as they may touch dangerous voltage points or short-out parts that could result in a fire or electric shock. Never spill liquid of any kind on the product.

19. Servicing

Do not attempt to service this product yourself as opening or removing covers may expose you to dangerous voltage or other hazards. Refer all servicing to qualified service personnel.

20. Damage Requiring Service

Unplug this product from the wall outlet and refer servicing to qualified service personnel under the following conditions:

- If the power-supply cord or plug is damaged.
- If liquid has been spilled, or objects have fallen into the product.
- If the product has been exposed to rain or water.
- If the product does not operate normally by following the operating instructions. Adjust only those controls that are covered by the operating instructions as an improper adjustment of other controls may result in damage and will often require extensive work by a qualified technician to restore the product to its normal operation.
- If the product has been dropped or the cabinet has been damaged.
- If the product exhibits a distinct change in performance.

21. Replacement Parts

When replacement parts are required, be sure the service technician has used replacement parts specified by the manufacturer or have the same characteristics as the original part. Unauthorized substitutions may result in fire, electric shock, or other hazards.

22. Safety Check

Upon completion of any service or repairs to this product, ask the service technician to perform safety checks to determine that the product is in proper operating condition.

23. Wall or Ceiling Mounting

The product should be mounted to a wall or ceiling only as recommended by the manufacturer. The product may slide or fall, causing serious injury to a child or adult, and serious damage to the product.

24. Heat

The product should be situated away from heat sources such as radiators, heat registers, stoves, or other products (including amplifiers) that produce heat.

Table of Contents

Safety Warnings	2	VIDEO Menu Options	29-30
Important Safety Instructions	3-4	AUDIO Menu Options	31-32
Function Status Indicators	6	TIME Menu Options	
Step 1. Hook Up TV		Auto Clock Setup	33
Rear Connections Panel	7	Manual Clock Setup	34
Front Connections Panel	8	TV Turn Off Time Setup	35
ANT/Cable Service Hookup	9	TV Turn On Time Setup	36
Cable Box Connections	10	Sleep Timer Setup	37
VCR Connections	11	Auto Off	38
DVD Player	12	SPECIAL Menu Options	
RGB/DVI-HD/STB Input	13	Aspect Ratio	39
RGB-PC/DVI-PC Input	14	Captions Setup	40
External Stereo Connections	15	Caption/Text Mode Selection	41
Home Theater: Speaker Layout	16	On-Screen Menus Language	42
Monitor Out Setup	17	EZ Demo (Menu Review)	43
Remote Control Functions In TV Mode	18-19	LOCK Menu Options	
On-Screen Displays	20	Parental Lock Setup	44-46
Front Panel Controls	21	Step 3. Miscellaneous	
Step 2. Customize your TV's Features		Programming the Remote	47
SETUP Menu Options		Programming Codes	48-51
EZ Scan (Channel Search)	22	Maintenance	52-53
Channel Add/Del/Surf Setup	23	Troubleshooting	54-55
Channel Label Setup	24	Glossary	56-57
Main Picture Source Selection	25	Product Specifications	58
PIP (Picture-in-Picture)	26	Warranty	59-60
PIP (Picture-in-Picture) Operation	27		
POP (Picture-out-of-Picture)	27		
Twin Picture	28		

Setup Checklist

Step 1. Make all equipment and source connections.
See pages 6-17.

Step 2. Install batteries in remote control and do a channel search.
See page 22.

Step 3. Adjust and fine-tune TV features and options to your preference.
See contents above.

Note: Design and specifications are subject to change without prior notice.

Function Status Indicators

Lamp indicator, operation indicator, and temperature indicator located below the front panel controls, reveal the operating status of the DLP projection TV.

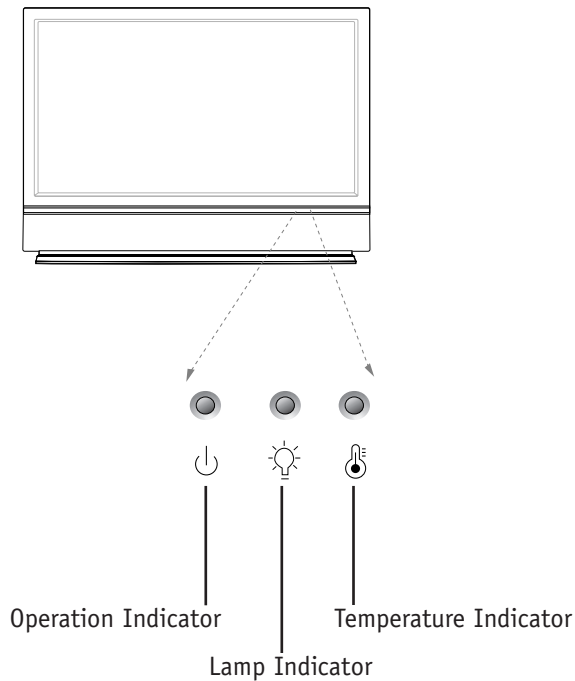

Operation Indicator	Off	Power cord is not connected.
	Red	Power Cord is connected, TV is in standby mode.
	Green	On
	Orange (flashing)	Preparing operation in standby mode.
Lamp Indicator	Orange	Projection lamp is reaching the end of its life and needs to be replaced with a new lamp.
	Red (flashing)	There is a problem with the lamp or around it. Contact an authorized service center.
	Green (flashing)	The lamp cover is not closed.
Temperature Indicator	Orange	The projection TV is overheating.
	Red	The projection TV shut down due to overheating.
	Red (flashing)	The projection TV shut down, check the cooling fan.

Rear Connections Panel

Connecting cables and external equipment to your TV.

This manual explains the features available on the RU-52SZ51D TVs.

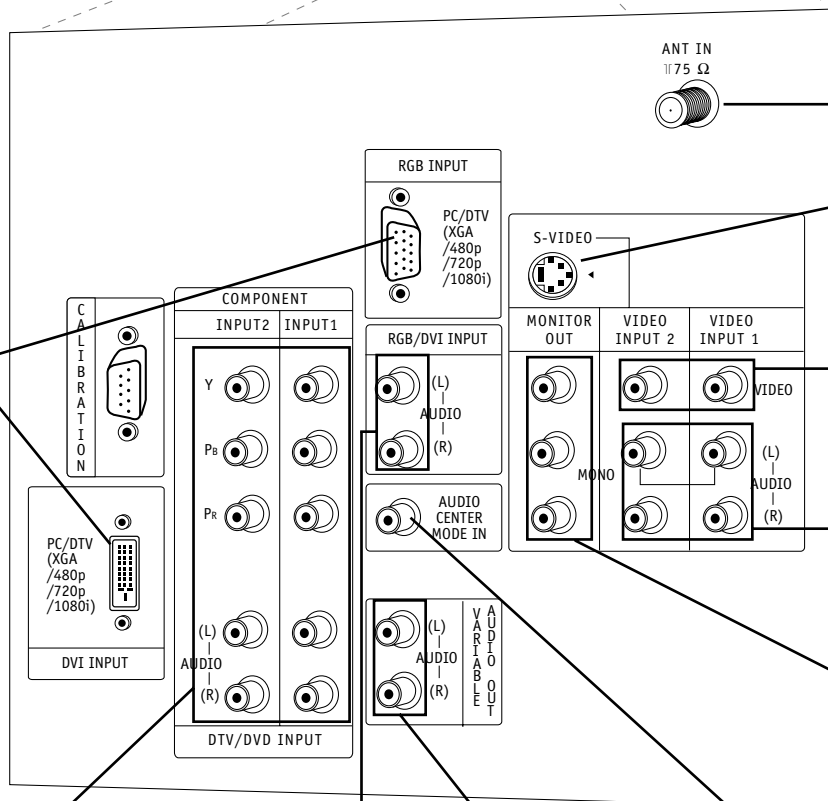
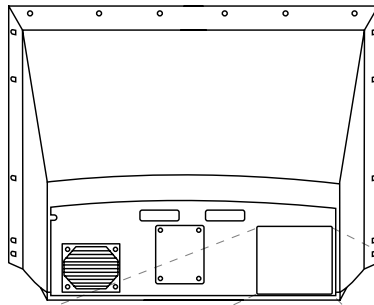

RF Connector: Antenna
Used to connect analog cable or antenna signals to the television, either directly or through your cable box.

S-VIDEO In
A connection available with some high-end equipment that provides even better picture quality for Video 2.

Video 1 or 2
Connects the video signals from various types of equipment.

Left/Right Audio
Used for stereo sound from various types of equipment.

Monitor Out
Connects to a second TV or Monitor.

PC and HD-STB Input
Used to connect from a PC source or HD-STB Satellite system.

**Y, Pb, Pr
DVD Component Video and HD Component Video**
Some top-of-the-line DVD players use what is called "component video," for extremely accurate picture reproduction. Refer to your DVD manual for further information.

PC and HD-STB Audio Input
Used for audio connections from a PC source or HD-STB Satellite system.

Variable Audio Out
Used to connect either an external amplifier, or add a sub-woofer to your surround sound system.

Audio Center Mode In
Connect to external Dolby Digital Center "preamp output."

Mini glossary

- JACK** A connection on the back of a TV, VCR, or any other A/V device. This includes the RF jack and the Audio/Video jacks that are color-coded.
- SIGNAL** Picture and sound traveling through cable, or over the air, to your television screen.

Front Connection Panel

There are four jacks on the left front side behind the screen on your projection TV that make connecting Audio/Video devices like video games and camcorders very simple.

The jacks are like those found on the back jack connection panel. This means that most equipment that connects to those types of jacks on the rear jackpack, may be connected to the front connection panel.

To use the front jacks as the signal source, select them using Main Input menu as described on page 25. They will be named "Front Video" in the Main Input menu.



If you select either Front Video or Front S-Video, the Front audio inputs are automatically selected as well.



If you're connecting a video game device, make sure to change the picture settings with the EZ Picture option in the Video menu (see page 29).

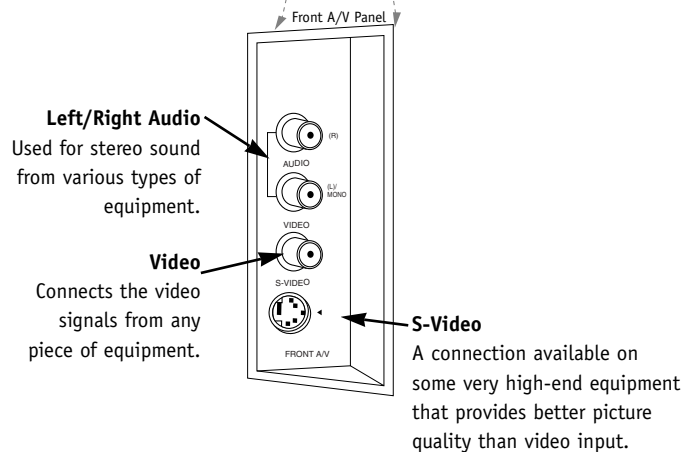
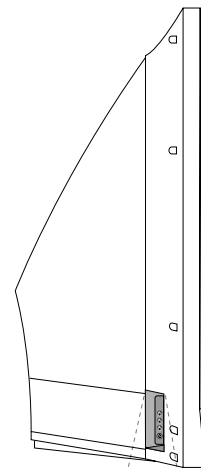

Mini glossary

A/V CABLES Audio/Video cables. Three cable connector—Right audio (red), Left audio (white), and Video (yellow). A/V cables are used for stereo playback of videocassettes and for higher quality picture and sound from other A/V devices.

A/V DEVICE Any device that produces video or sound (VCR, DVD, cable box, or television).

ANT / Cable Service Hookup

1

Connect an antenna and/or cable service to your TV as shown.

2

Turn to page 22 to do a channel search with EZ Scan for Ant/Cable connection(s).

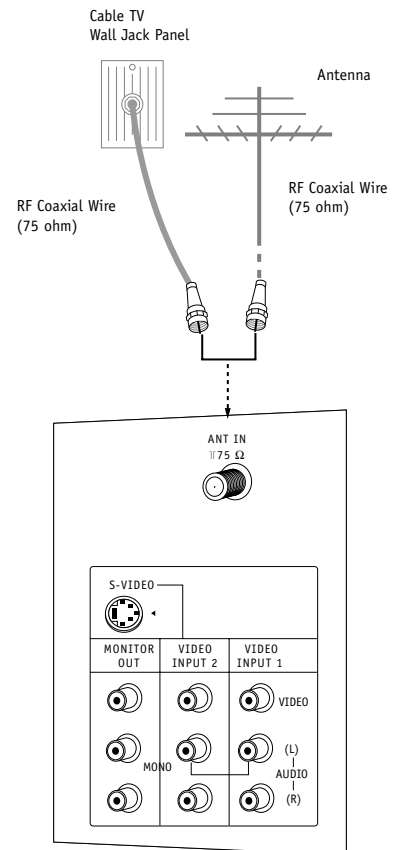

If you receive your RF signal through an antenna that is several years old and connects with two small prongs, you will need to purchase a 300 to 75 ohm adapter. It should be available from your local electronics dealer.



We recommend using a 75 ohm cable for your antenna connections in order to prevent interference.

For best signal reception, it is recommended to have your Antenna professionally adjusted.

Cable Box Connections

1

Locate the output jack on the back of your cable box. Connect this to the Antenna jack on the back of your TV.

Or find the composite video and audio jacks on the back of your cable box, and connect them following the instructions provided with your equipment. This can be combined with any other equipment you may want to hook up.

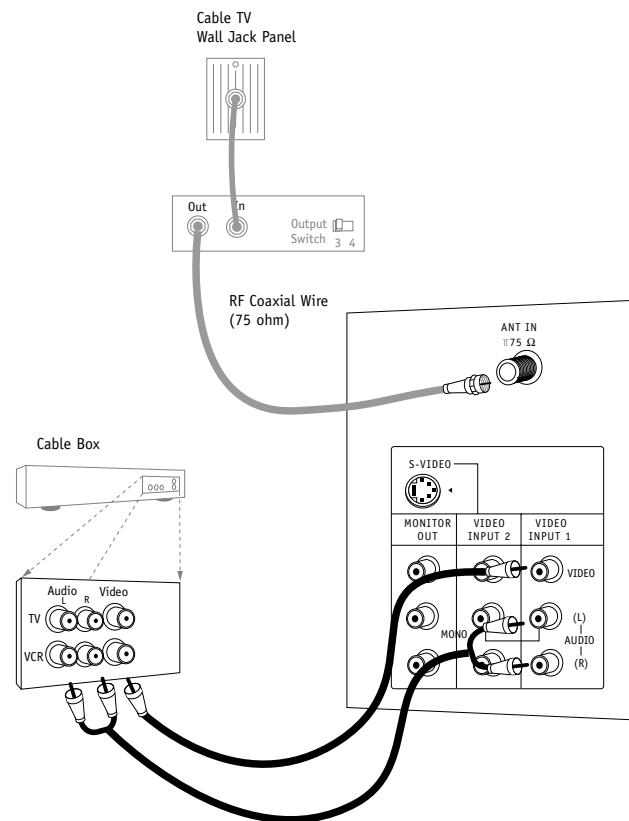

If you're using a cable box, leave the TV on channel 3 or 4 and use your cable box to change channels.

VCR Connections

1

Locate the Antenna jack on the back of your TV. Connect this to RF out jack on the back of your VCR.

Or, find the composite video and audio jacks on the back of your VCR, and connect them following the instructions provided with your equipment.

You may connect either the composite video or the S-Video cables to your TV. (Do not connect both the composite and the S-Video cables. In the event that you connect both composite and the S-Video cables, only the S-Video will work.)

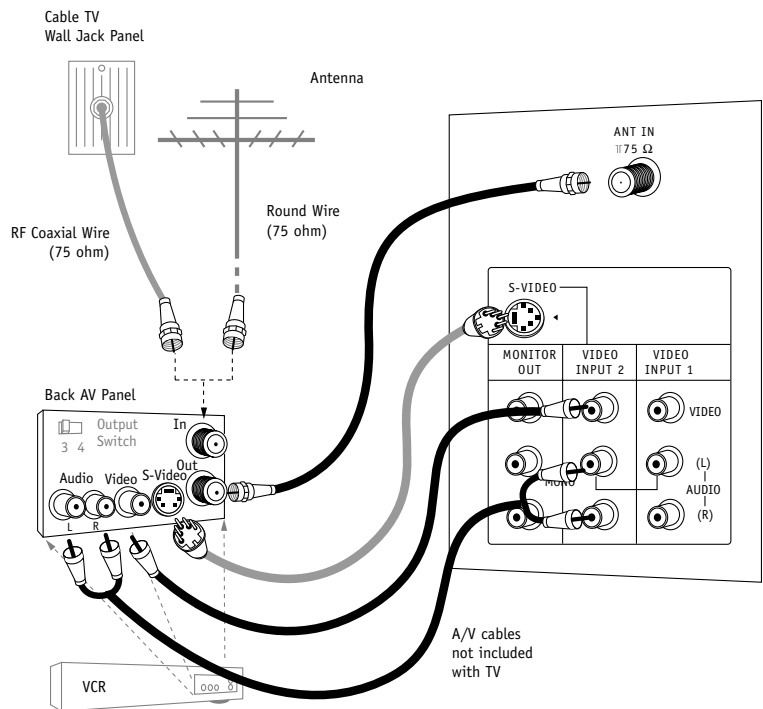

To hear stereo sound from cable or your VCR, you will need to connect A/V cables as well as the wire that runs from the VCR to your TV.



If you want to receive your signals on Channel 3 or 4, locate the Out to TV jack on your VCR. Connect a cable from the Out to TV jack to the Antenna In jack on the back of your TV.



After connecting external equipment to the TV, don't display a still picture for a long time on the screen. Doing so may damage the TV screen.

1

Find the audio and component or S-Video jacks on the back of your DVD Player and connect them following the instructions provided with your equipment.

You may connect either the composite video or the S-Video cables to your TV. Do not connect both the composite and the S-Video.

Some high-end DVD players use a picture reproduction system called "component video." If your DVD player has component output, use the connectors marked "Component 1/2" on the jack panel. Please refer to your DVD manual for proper installation.

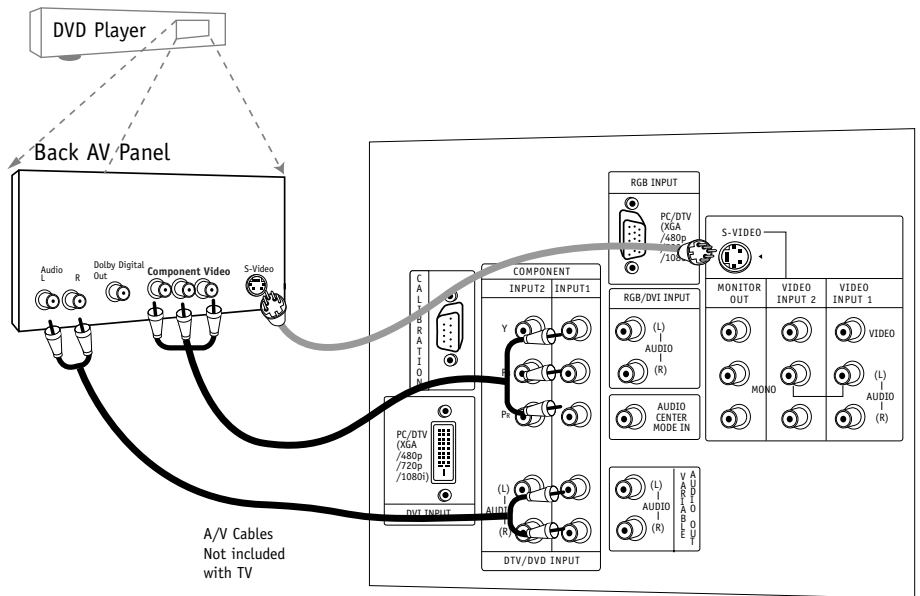

Component 1 (or 2) Input

Y	P _B	P _R
1920X1080i		
1280X720p		
720X480p		
720X480i		

• Component Input ports

Connect DVD player jacks to Monitor Component input jacks as indicated below.

Component input jacks on the Monitor	Y	P _B	P _R
Video output jacks on DVD player	Y	P _b	P _r
	Y	B-Y	R-Y
	Y	C _b	C _r
	Y	P _B	P _R

Mini glossary

COMPONENT VIDEO Some video equipment uses three separate lines (Y, P_B, P_R) to more precisely reproduce images. Your video equipment manual will explain how this relates to your equipment.

RGB/DVI-HD/STB Input

1

Find the audio and Y, P_B, P_R/RGB/DVI jacks on the back of your DBS receiver and connect them following the instructions provided with your equipment.

2

Connect these cables to your TV as shown.

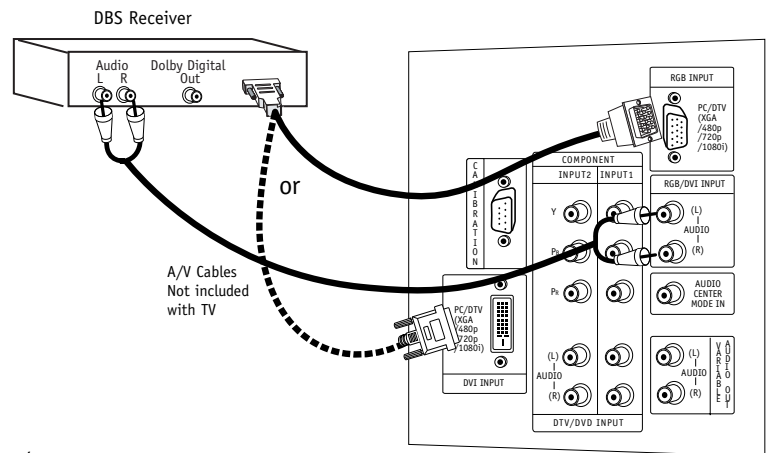
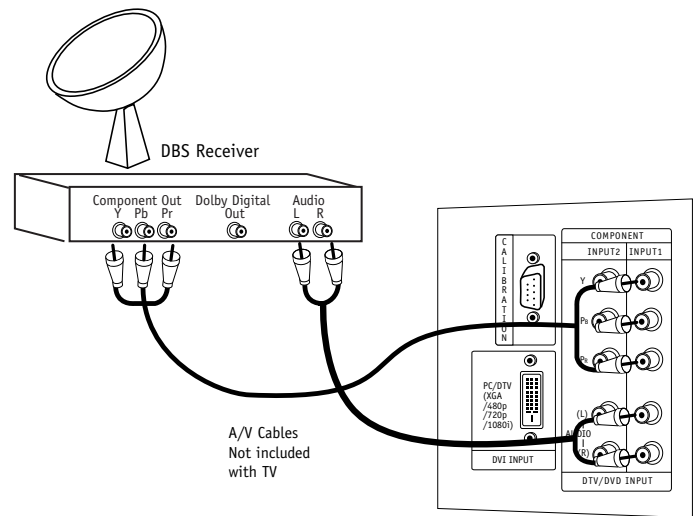

The DTV shows the sharpest picture in 720p mode.



This TV supports HDCP (High-baudwidth Digital Contents Protection) protocol for DVI-DTV (480p, 720p, 1080i) mode.



Select RGB-DTV Source and press ENTER. Use UP/DOWN arrows to select the desired options (V-position/H-position/PHASE) and then use LEFT/RIGHT arrows to make appropriate adjustments.



In RGB-DTV mode, V-position/H-position/PHASE are not adjustable if you choose either the POP or Twin picture modes.

RGB-HD/STB Input

HD-SET TOP
1920x1080i
1280x720P
720x480P

Signal	Component1	Component2	RGB/DVI-DTV
480i	Yes	Yes	No
480p	Yes	Yes	Yes
720p	Yes	Yes	Yes
1080i	Yes	Yes	Yes

RGB-PC/DVI-PC Input

1 Find the audio and RGB or DVI jacks on the back of your PC and then connect them following the instructions provided with your equipment.

2 Connect these cables to your TV as shown.

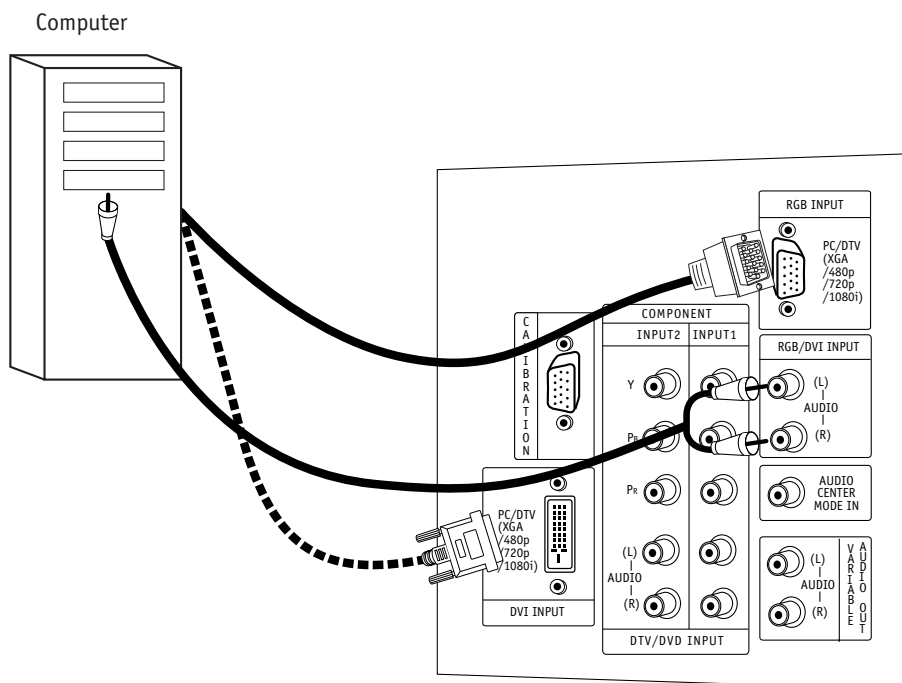

Select RGB-PC Source and press ENTER. Use UP/DOWN arrows to select the desired options (V-position/H-position/V-size/H-size/PHASE) and then use LEFT/RIGHT arrows to make appropriate adjustments.

- **Vertical position, Horizontal position, Vertical size, and Horizontal size:** Based on the input mode (resolution), the adjustment ranges may change.

- **PHASE:** Removes any horizontal noise and clears up or sharpens the character images. Adjustment range is -15 ~ + 15.



In DVI-PC mode, adjustments are only Vertical size, and Horizontal size.



In RGB-PC/DVI-PC modes, for POP or Twin screen, V-position/H-position/V-size/H-size/PHASE are not adjustable.



Synchronization input form: Signals are separate.

RGB-PC/DVI-PC Input

MODE	Resolution	Horizontal	Vertical
Text	640x350	31.5KHz	70Hz
	640x480	31.5KHz	60Hz
VGA	640x480	37.9KHz	72Hz
	640x480	37.5KHz	75Hz
SVGA	800x600	35.2KHz	56Hz
	800x600	37.9KHz	60Hz
	800x600	48.1KHz	72Hz
	800x600	46.9KHz	75Hz
XGA	1024x768	48.4KHz	60Hz
	1024x768	56.5KHz	70Hz
	1024x768	60.0KHz	75Hz

External Stereo Connections

Connect Left/Right Variable Audio Output to an external Audio Amplifier System.

- 1 Locate both Variable Audio Out jacks on the back of your TV and the Left/Right audio input jacks on the back of your stereo's amplifier.
- 2 Connect these jacks, making sure that they are connected correctly (red=Right, white=Left.)
- 3 Adjust the sound on your stereo, according to directions provided with the amplifier.

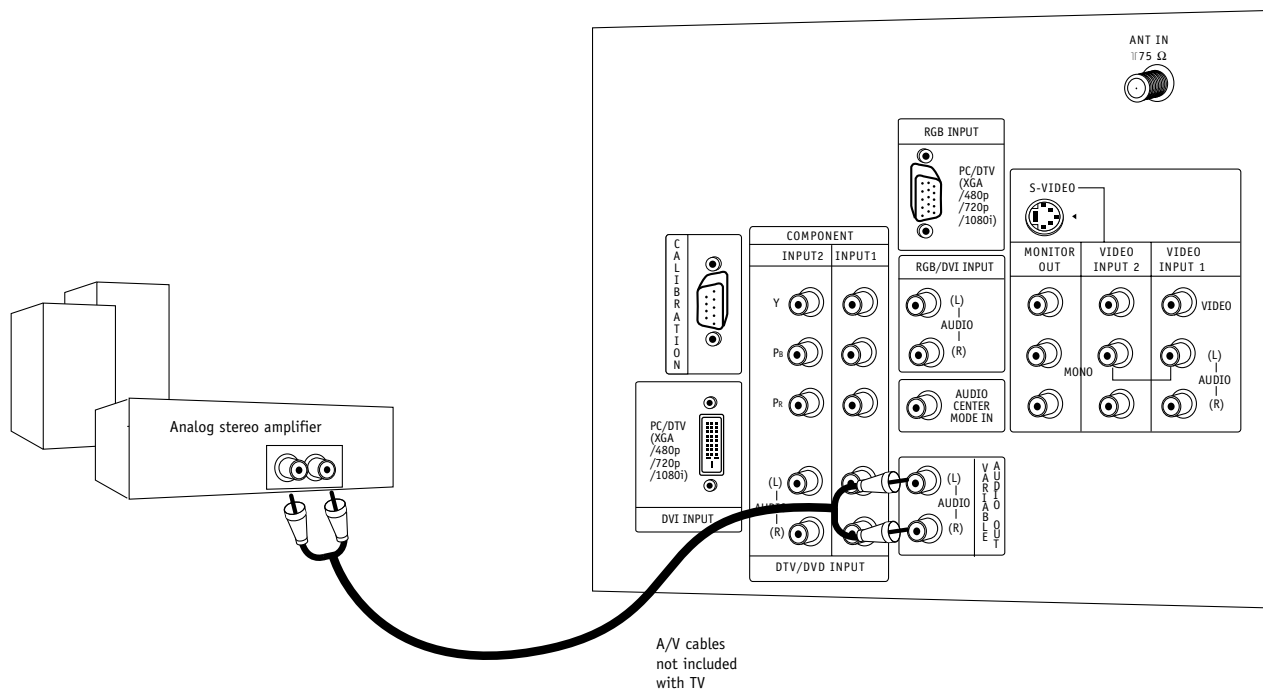

Home Theater: Speaker Layout

This is a typical speaker layout. Any number of other speaker setups are possible, and some changes may be needed to maximize your sound. However, a Dolby Digital Receiver is required to hear 5.1 channel audio.

Left and right speakers on each side of the TV enhance separation. The TV's sound optional hookup "center mode in," makes the dialog sound as though it's coming directly from the TV. The rear surround sound speakers provide the majority of other sounds, like those from special effects in movies. Your sub-woofer generates ultra-low frequency sound, for rumbling low-end audio.

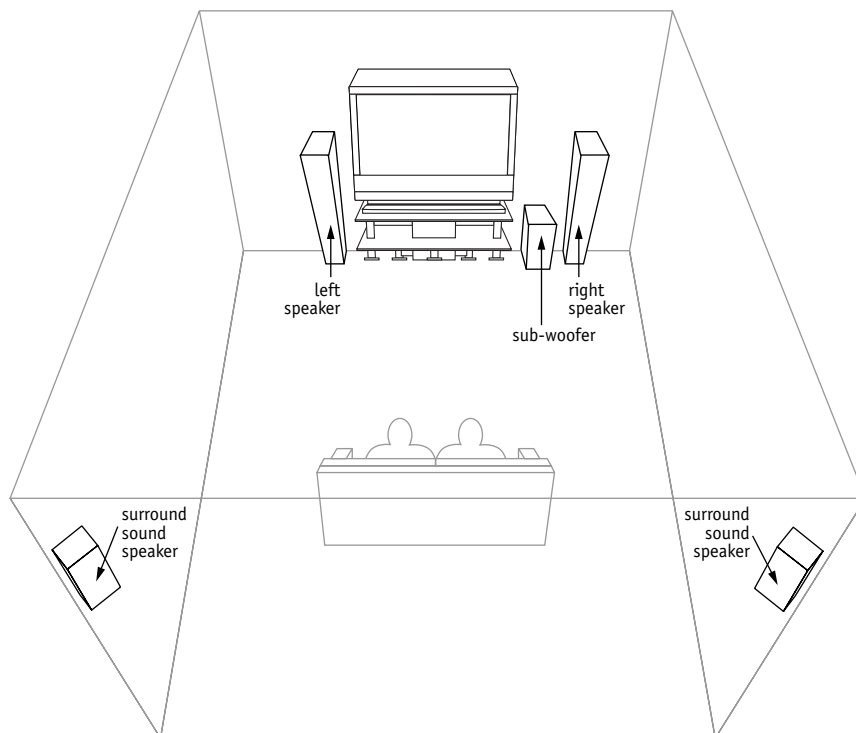

Sound is affected by speaker placement, so make sure nothing is in front of the speakers, and that they are aimed in appropriate directions.



You have the option of turning the TV speakers on or off.

Monitor Out Setup

1

Your TV has a special signal output capability which allows you to hook up a second TV or monitor.

2

Just connect the second TV or monitor to the MONITOR OUT Audio/Video jacks located on the back of your TV. See the Operating Manual of the second TV or monitor for further details regarding that device's input settings.

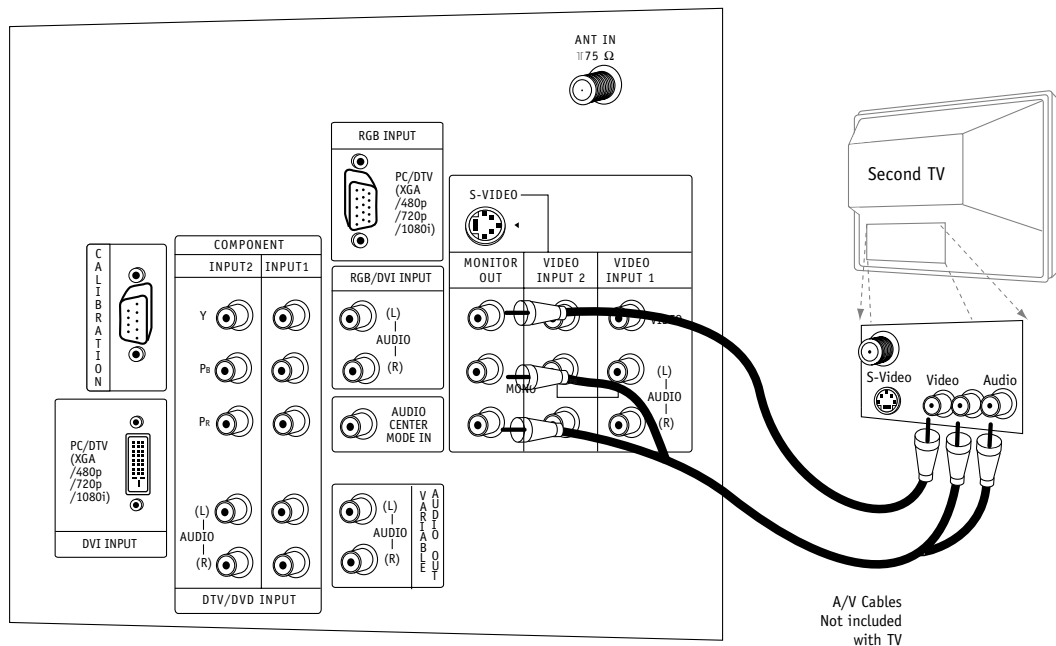

Component 1 - 2, RGB-DTV/PC, and DVI-DTV/PC input sources for main picture cannot be used for Monitor Out.

Remote Control Functions in TV Mode

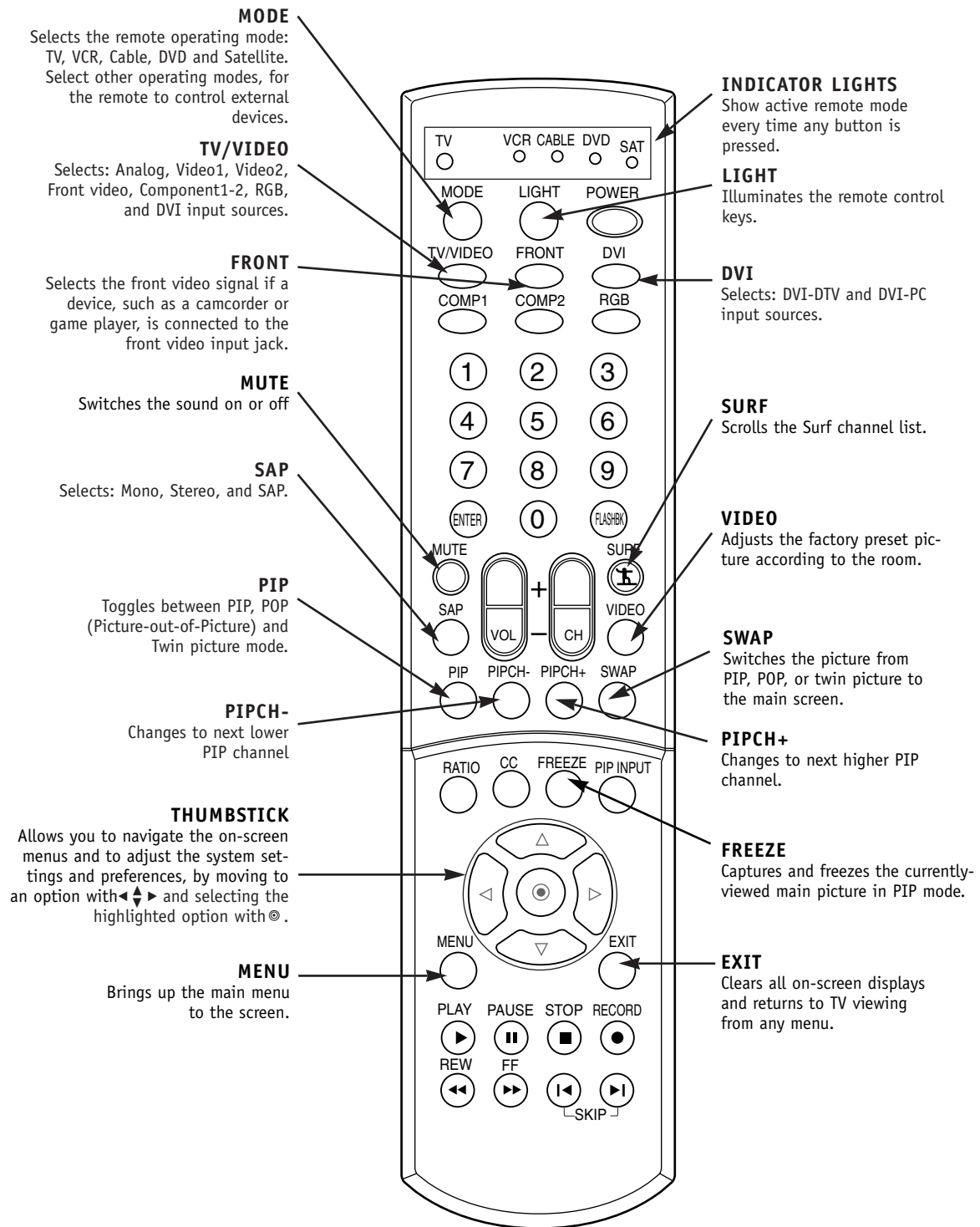

Remote Control Functions in TV Mode

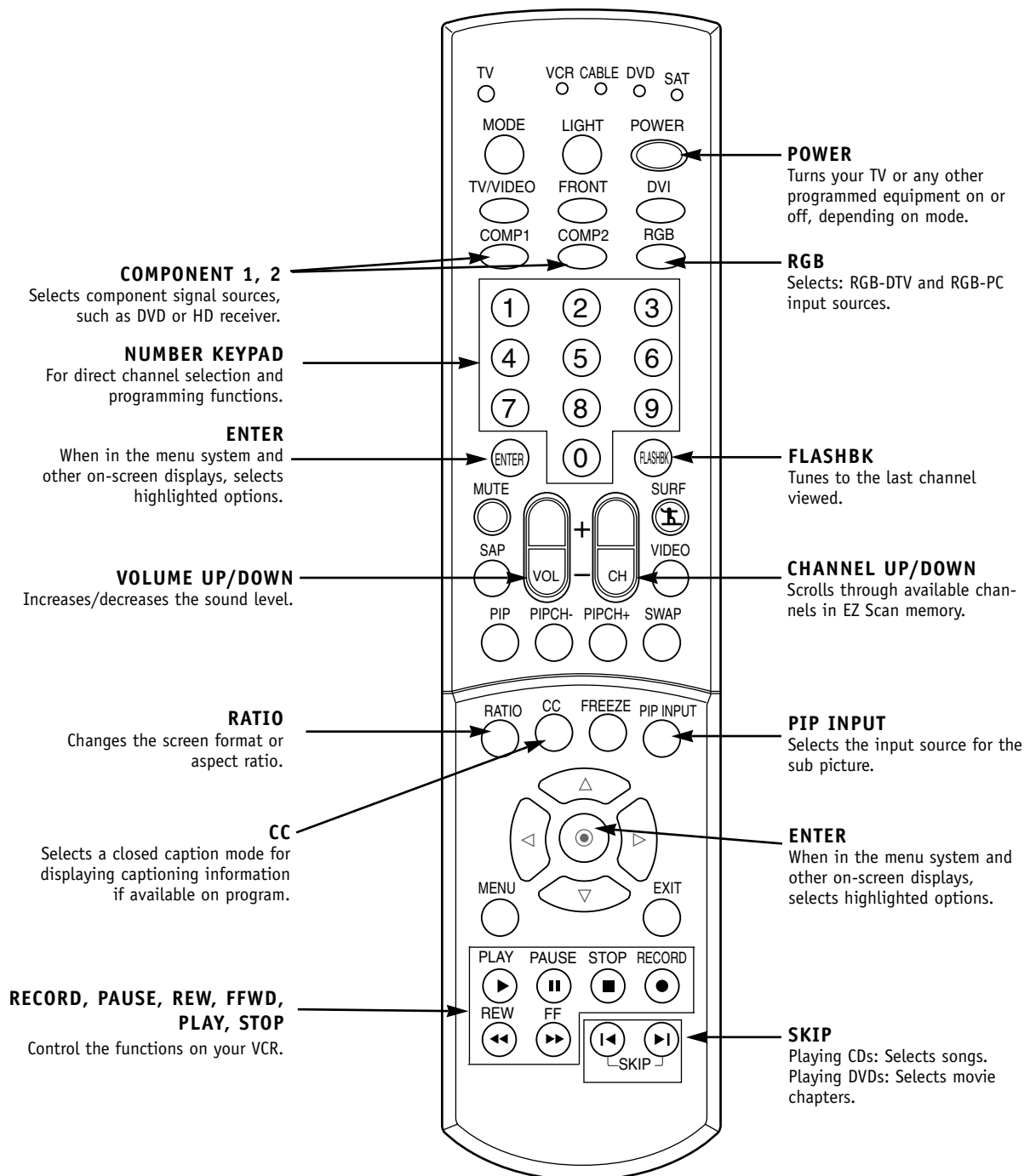

On-Screen Displays

This page describes your on-screen display and information banner options.

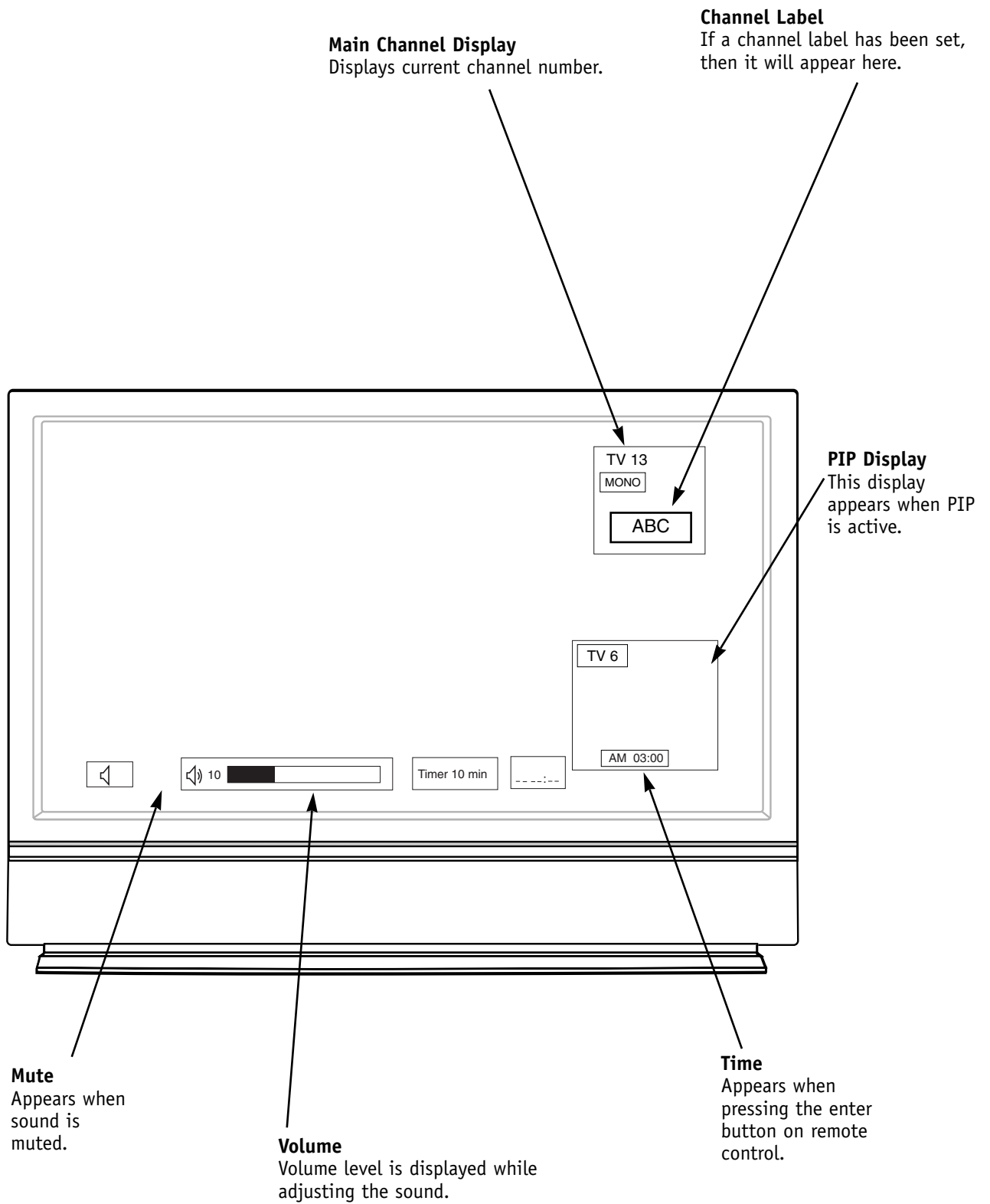

Front Panel Controls

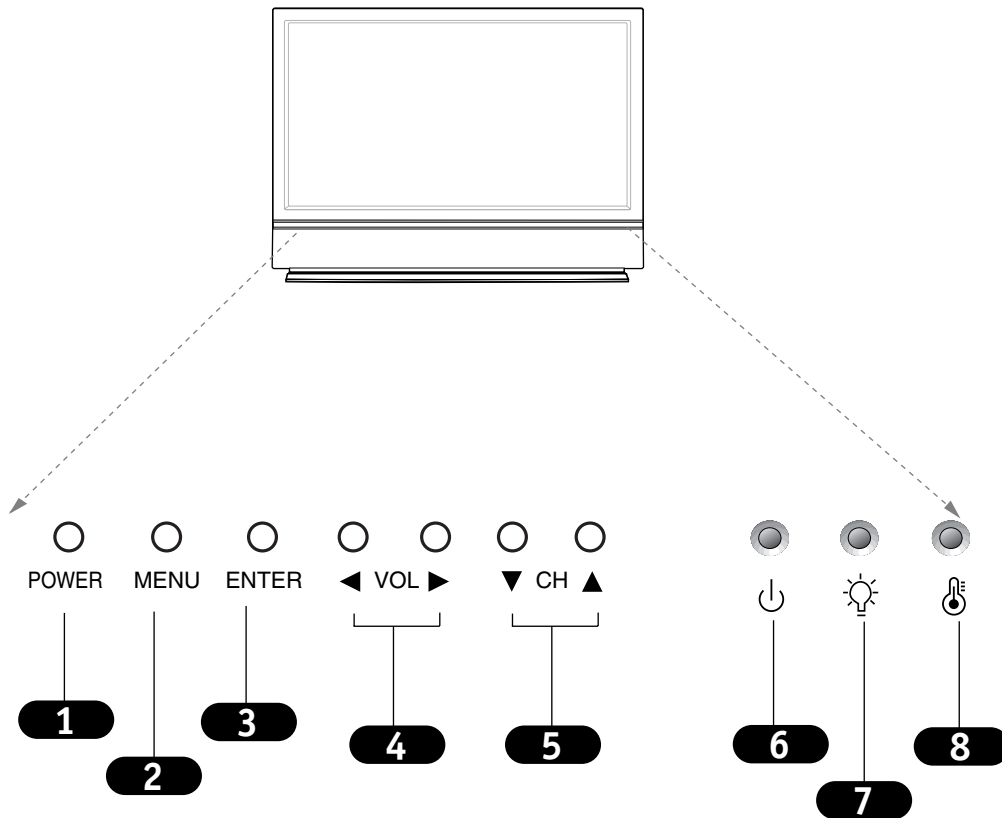

- 1** POWER
- 2** MENU
- 3** ENTER (Same as ENTER button on your remote control)
- 4** VOLUME UP / DOWN
- 5** CHANNEL UP / DOWN
- 6** Operation indicator. (See page 6).
- 7** Lamp indicator. (See page 6).
- 8** Temperature indicator. (See page 6).



See menu pages for instructions on using the on-screen menus.



The POWER, CHANNEL, TV/VIDEO, and VOLUME buttons work just as they do on your remote control.



If TV is moved from cold to normal room temperature, humidity may form inside TV, wait 3 hours for TV to adjust to room temperature before turning it on.

- This manual explains the features available on the RU-52SZ51D TVs.

EZ Scan (Channel Search)

Automatically finds analog channels available through ANT IN input, and stores all active over-the-air and cable channels in memory on the channel list.

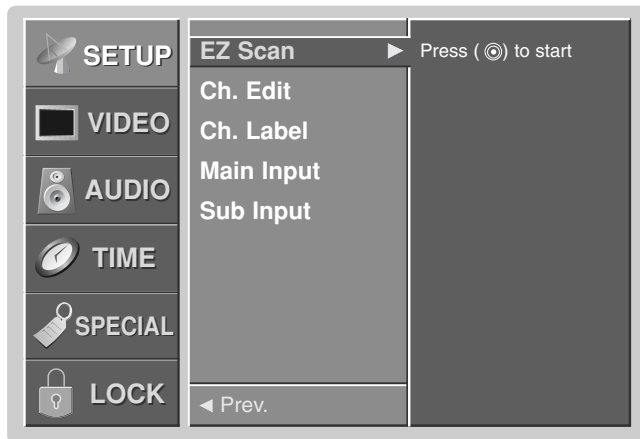

- 1 Refer to pages 7-15 to connect external equipment to your TV. If you have not done so, plug in your TV to a standard 120V 60Hz power outlet.

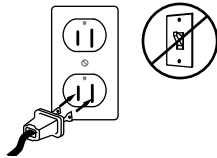

- 2 If you have not done so, remove the back of the remote and install in two AA batteries. Make sure batteries are properly installed (check the +/- symbols).

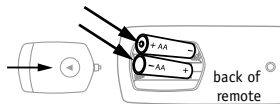

- 3 With the remote control in hand, press the POWER button to turn your TV on.
- 4 Press the MENU button on the remote control, then use the UP/DOWN arrow button to select the Setup menu.
- 5 Press ENTER or the RIGHT arrow button to access the Setup menu.
- 6 Use the UP/DOWN arrows to select EZ Scan.
- 7 Press ENTER or the Right arrow button to start the EZ Scan channel search.

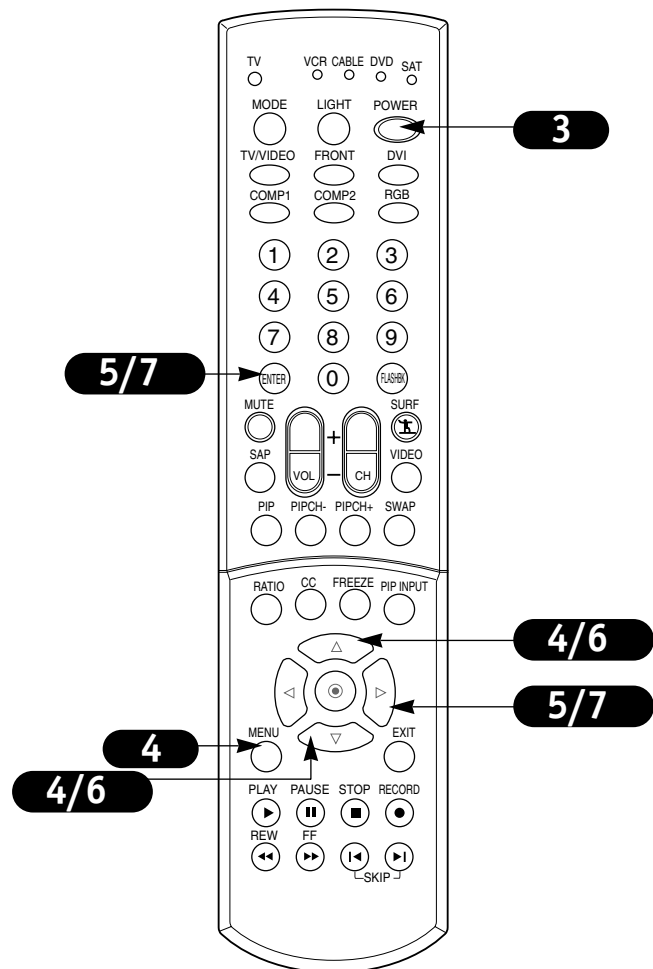

Channel Add / Del / Surf Setup

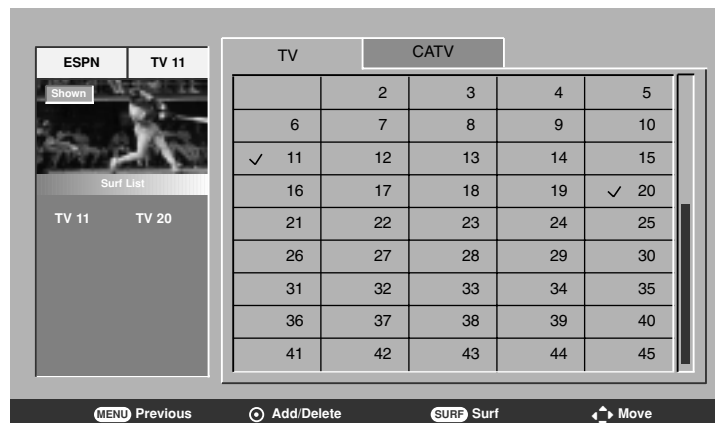
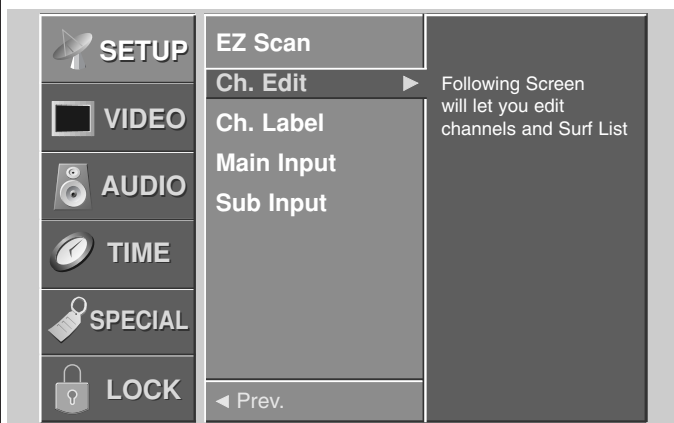

Create two different types of channel lists in memory: "Custom list" and "Surf list".

A custom list can be created by toggling each channel on or off with **ENTER** (Enter). Once a channel is highlighted, you will be able to see whether the channel is currently added or deleted by referring to the small window at the top-left corner of the screen.

You can create your own Surf list with up to 16 channels. It appears at the bottom-left corner of the screen.

Press the Surf button on the remote control when a channel is highlighted to add or delete the channel in the Surf list.

- 1** Press the MENU button on the remote control, then use the UP/DOWN arrow button to select the Setup menu.
- 2** Press ENTER or the RIGHT arrow button to access the Setup menu.
- 3** Use the UP/DOWN arrows to select Ch.Edit and then press ENTER or right arrow.
- 4** You will now see a screen filled with channel numbers and a preview picture. Use the UP/DOWN and LEFT/RIGHT arrows to select a channel, then use ENTER to Hide or Show it. Press SURF to add the channel to the Surf List.
- 5** Press EXIT to save and return to TV viewing or press MENU to save and return to the previous menu.

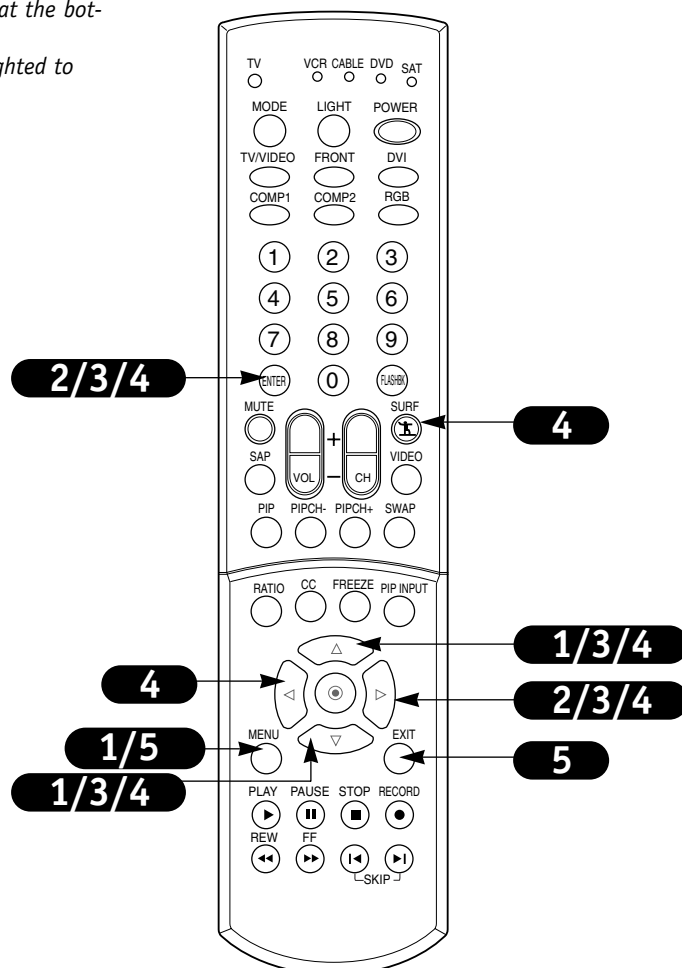

Channel Label Setup

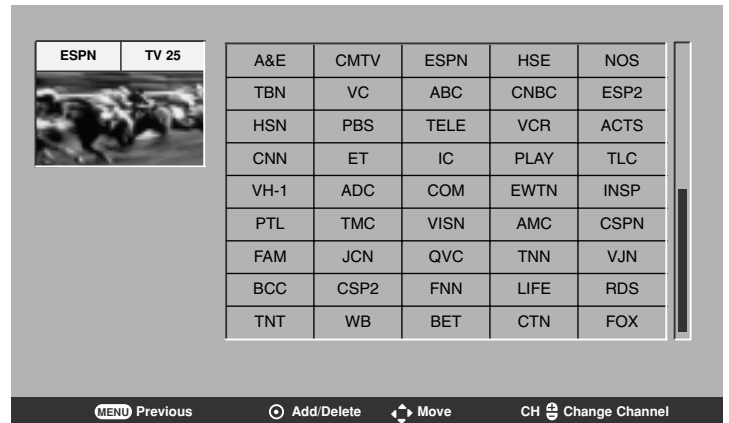
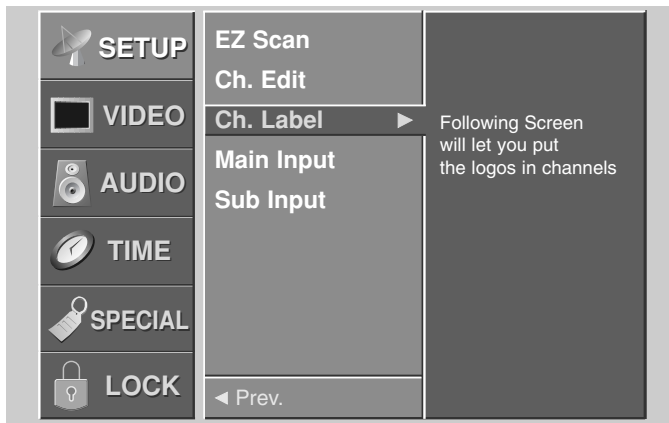

1

Press the MENU button on the remote control, then use the UP/DOWN arrow button to select the Setup menu.

2

Press ENTER or the RIGHT arrow button to access the Setup menu.

3

Use the UP/DOWN arrows to select the Ch. Label option.

4

Press ENTER or the RIGHT arrow to access the Ch. Label menu.

5

You will now see a screen filled with Labels and a preview screen. Use channel UP/DOWN button on your remote to select the a channel to Label.

6

Use the UP/DOWN and LEFT/RIGHT arrows to select the appropriate label for the channel or to select a blank label section for making a channel name.

- Use the UP/DOWN/LEFT/RIGHT arrows and press ENTER to set the Label to the selected channel.
- Use the UP/DOWN/ LEFT/RIGHT arrows and press SURF to edit channel name. Eight Eight blank channel sections are available. Use the LEFT/RIGHT arrows to select a word position and use the UP/DOWN arrows to change the letter. Press SURF to save.

7

Repeat 5 and 6 steps until all channels are Labeled.

8

Press EXIT to save and return to TV viewing.

Choose preset labels for your channels.

Use Channel +/- on your remote control in the Ch. Label menu to select a channel for labeling, then choose a suitable label for the channel by pressing to attach the label to the selected channel.

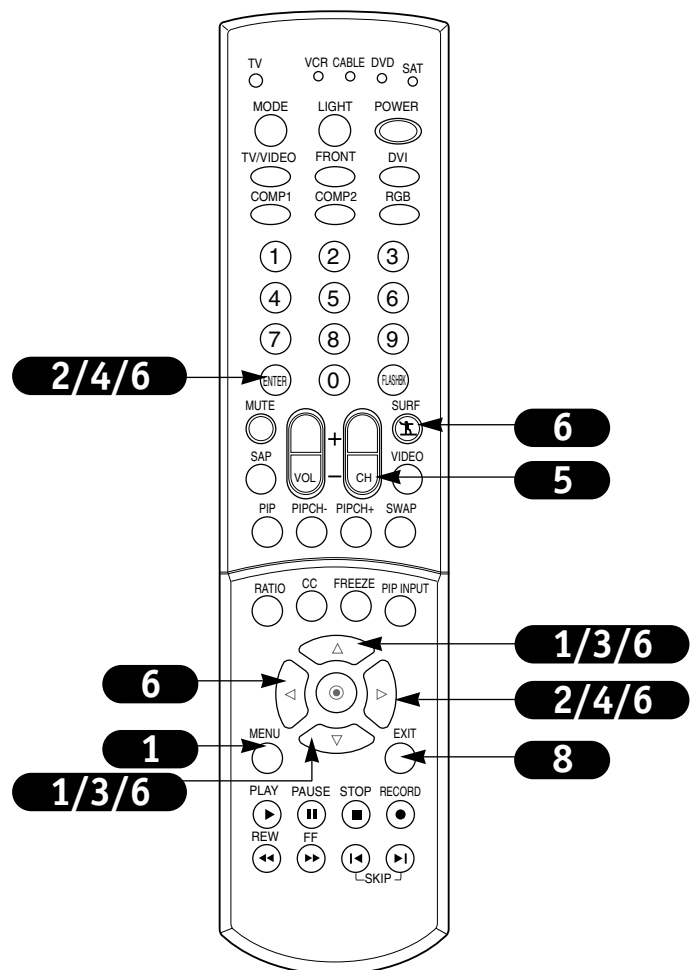

Main Picture Source Selection

Changes the picture source for the main screen so you can watch your off-air TV, cable TV, VCR, DVD, or any other devices that are connected to your TV.

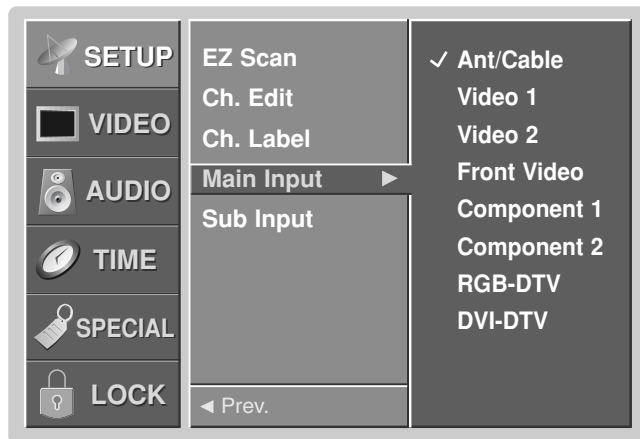

- 1** Press the MENU button on the remote control, then use the UP/DOWN arrow button to select the Setup menu.
- 2** Press ENTER or the RIGHT arrow button to access the Setup menu.
- 3** Use the UP/DOWN arrows to select Main Input.
- 4** Press ENTER or the RIGHT arrow to access the Main Input menu, then use the UP/DOWN arrow button to select a source. Your Main picture source options are : Ant/Cable, Video 1, Video 2, Front Video, Component 1, Component 2, RGB-DTV, RGB-PC, DVI-DTV, or DVI-PC.
- 5** Press EXIT to save and return to TV viewing or press the LEFT arrow to save and return to the previous Menu.

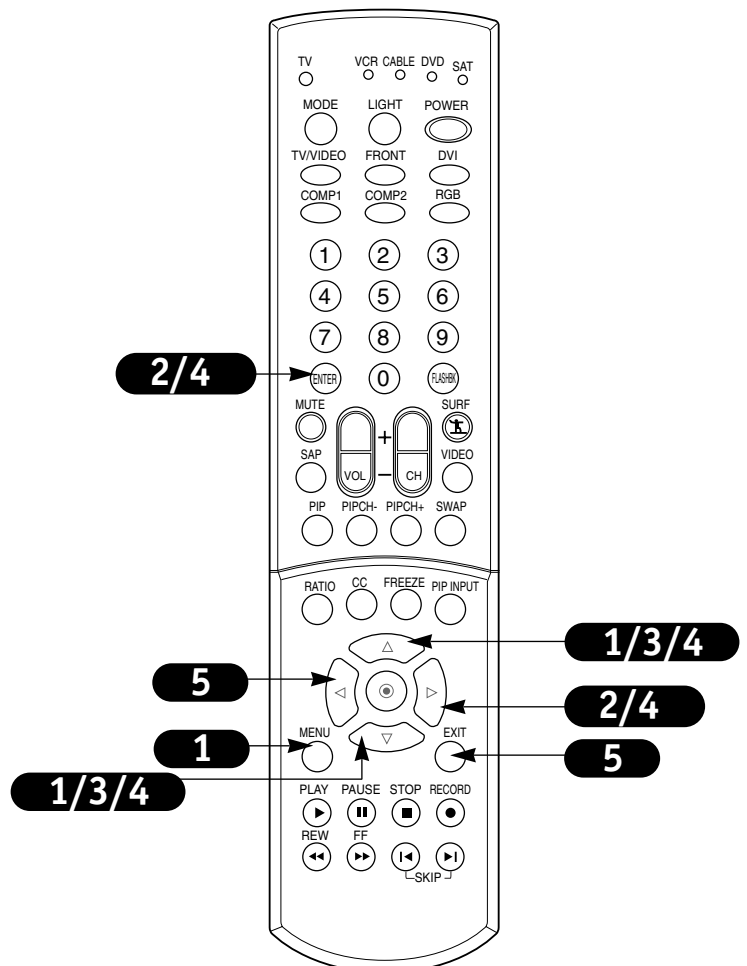

PIP (Picture-in-Picture)

PIP lets you view 2 different inputs (sources) on your monitor screen at the same time. One source will be large, and the other source (PIP) will show a smaller inset image.

Watching PIP

Press the PIP button to show the sub picture.
Each press of PIP changes the PIP options as shown below.

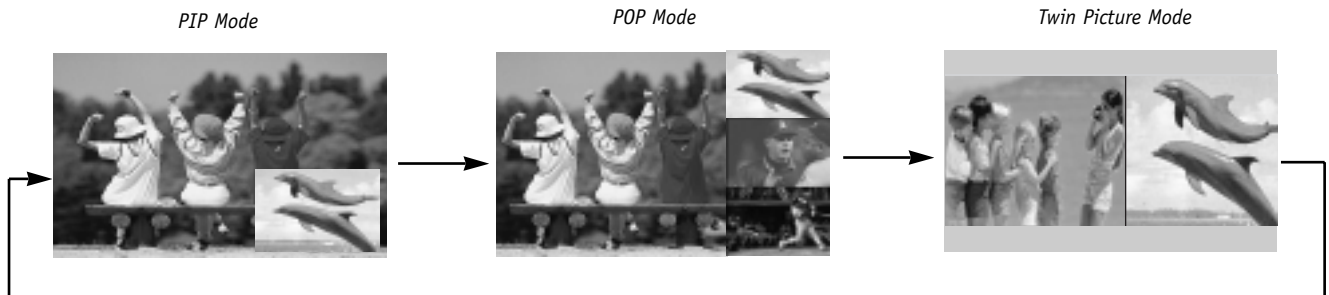

PIP Source Selection

Changes the picture source for the Picture-in-Picture image so you can watch your off-air TV, cable TV, VCR, or any other devices that are connected to your TV.

Using the menu

- 1 Press the MENU button on the remote control, then use the UP/DOWN arrow button to select the Setup menu.
- 2 Press ENTER or the RIGHT arrow button to access the Setup menu.
- 3 Use the UP/DOWN arrows to select the Sub Input option.
- 4 Press ENTER or the RIGHT arrow to access the Sub Input menu, then use the UP/DOWN arrow button to select the source. Your choices are: Ant/Cable, Video 1, Video 2, Front Video.
- 5 Press EXIT to save and return to TV viewing or press the LEFT arrow to save and return to the previous Menu.

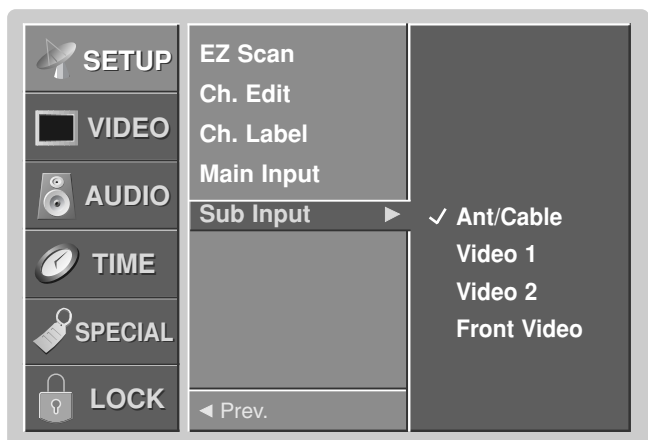

Do not display a fixed image on the screen for long periods of time. Doing so may cause image burn-in.



Not all sources are available for PIP.

Using the PIP INPUT button

- 1 Use the PIP INPUT button to select the input source for the sub picture. Each time you press PIP INPUT button, you toggle between Ant/Cable, Video 1, Video 2, and Front Video.

PIP (Picture-in-Picture) Operation

Selecting PIP Channels

- 1 Select the Ant/Cable source with the PIP INPUT button.
- 2 Use the PIPCH-/PIPCH+ button to select a channel for the sub picture.

Swapping Pictures

Press the SWAP button.
Each time you press the SWAP button, you switch the Main and PIP pictures.

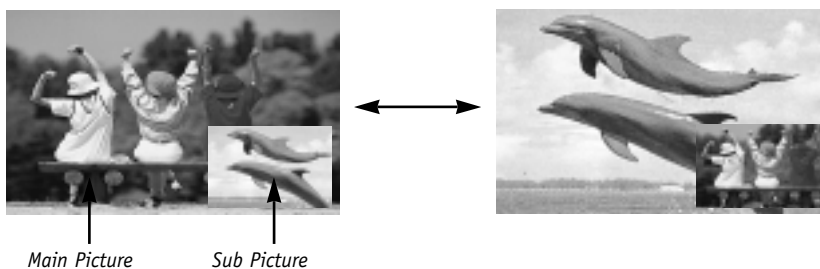

Moving the Sub Picture

In the PIP mode, each press of the UP/DOWN/LEFT/RIGHT arrow buttons will move the sub picture to a different position on the screen.

POP (Picture-out-of-Picture)

Use POP to search the pictures of all the programmed channels one-by-one on the 3 PIP screen display, while the main screen remains the current channel.

- 1 Press PIP on the remote control with the PIP image on the screen to activate POP (Picture-out-of-Picture) mode. The pictures of all the programmed channels are searched with the 3 PIP screen, as shown to the right.
 - Press SWAP, to enlarge the selected channel being searched on the PIP screen to view it on the Main screen. (Main and sub pictures can be swapped if main picture source is Ant/Cable.)
- 2 Press the EXIT button to exit POP mode.



Run EZ Scan channel search before using POP mode.

Twin Picture

Twin Picture splits the screen into 2, allowing 2 pictures to be shown on the TV screen at the same time. Each source is given half the screen.

Watching Twin Picture

- 1** Press the PIP button on the remote control in POP mode to activate twin picture mode. Select the Ant/Cable source with the PIP INPUT button.
- 2** Use the PIPCH-/PIPCH+ button to select the desired channel for the sub picture.

Swapping Pictures

Press the Swap button.
Each time you press SWAP, you switch the PIP and Main picture channels.

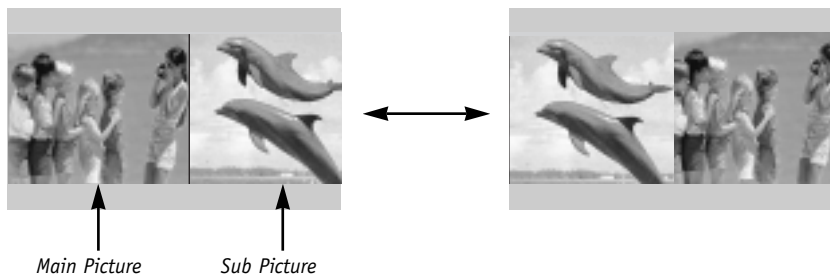

Selecting an Input Signal Source for Sub Picture

Use the PIP INPUT button to select the input source for the sub picture.
Each time you press PIP INPUT, you toggle between Ant/Cable, Video 1, Video 2, and Front Video.

Video Menu Options

Adjust the picture appearance to suit your preference and viewing situations.

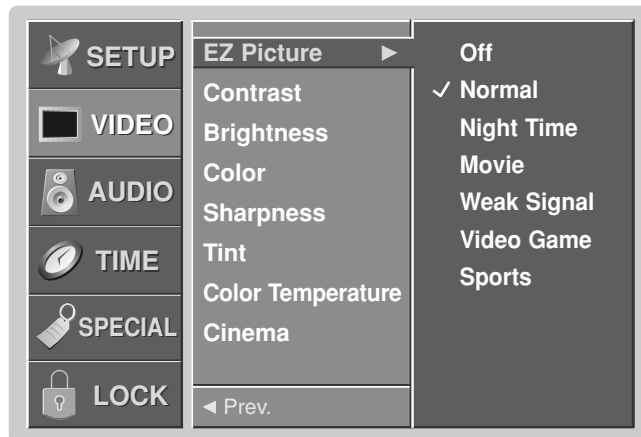

You can manually adjust the levels for the picture quality settings, such as Contrast, Brightness, Color, etc.

You can also select a preset value from the EZ Picture menu based on the category of the program.

- 1** Press the MENU button on the remote control, then use the UP/DOWN arrow button to select the Video menu.
- 2** Press ENTER or the RIGHT arrow button to access the Video menu.
- 3** Use the UP/DOWN arrows to select one of the following options: EZ Picture (Off, Normal, Night Time, Movie, Weak Signal, Video Game, and Sports), Contrast, Brightness, Color, Sharpness, Tint, Color Temperature (Warm, Medium, Cool), and Cinema. Then press ENTER or the Right arrow button.
- 4** Use the LEFT/RIGHT arrows to adjust the option to your preference (Contrast, Brightness, Color, Sharpness, Tint). Use the UP/DOWN arrows to set the option to your preference (EZ Picture, Color Temperature, Cinema).
- 5** Press EXIT to save and return to TV viewing or press the ENTER button to save and return to the previous menu.

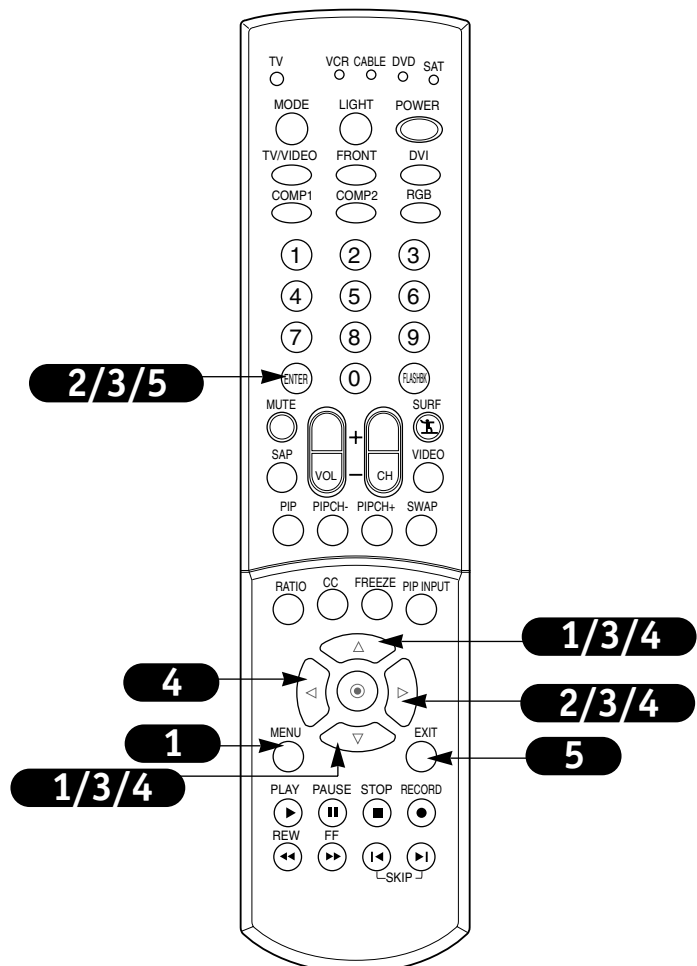

Video Menu Options

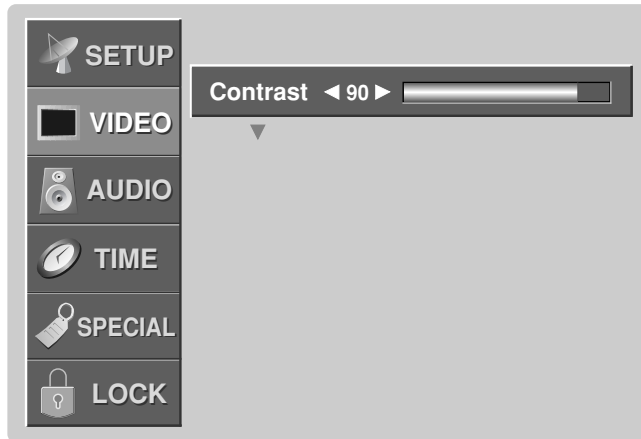

- **Contrast** Adjusts the difference between the light and dark levels of the picture. Press the right arrow button to activate adjusting.
- **Brightness** Adjusts the white or light level of the overall picture.
- **Color** Adjusts the intensity of all colors.
- **Sharpness** Adjusts the level of crispness in the edges between the light and dark areas of the picture. The lower the level, the softer the image.
- **Tint** Adjusts the balance between the red and green levels.
- **EZ Picture** Lets you choose a preset value for the picture settings.
 - Off** Lets you adjust the picture manually to your preferences.
 - Normal** Restores the picture levels to their original settings.
 - Night Time:** Increases the levels of all picture settings to fit daylight conditions.
 - Movie** Adjusts Video settings to enhance Movie viewing. Contrast and Sharpness levels are lowered so that the picture looks warm and soft. 3:2 cinema collection is only applied when choosing the Movie option in EZ Picture.
 - Weak Signal** Adjusts the picture settings to compensate for weak signal reception. Contrast, Color and Sharpness levels are lowered to hide picture imperfections.
 - Video Game** Sets the picture settings to the levels that are more suitable to enjoy games. Color, Contrast and Sharpness levels are lowered to reduce the amount of glare.
 - Sports** Sets the picture settings to the levels that are more suitable to view sporting events. Contrast and Color levels are raised so that an action scene appears clear and brilliant.
- **Color Temperature** Adjusts levels of all colors in the TV picture: Warm, Medium, or cool.
- **Cinema** Adjust the TV to the best picture when you watch movie.

Audio Menu Options

Adjust the sound to suit your taste and room situations.

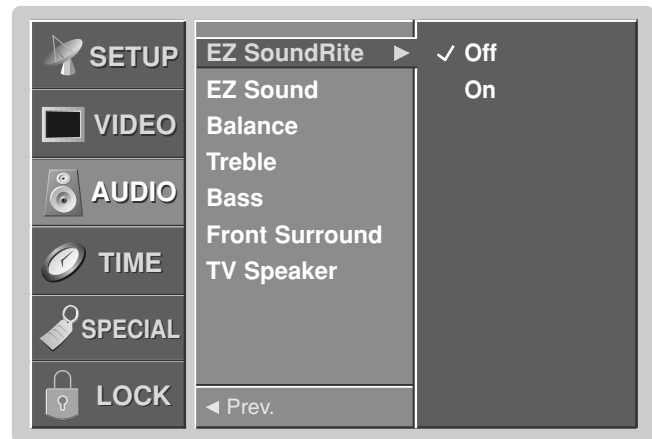

1 Press the MENU button on the remote control, then use the UP/DOWN arrow button to select the Audio menu.

2 Press ENTER or the RIGHT arrow button to access the Audio menu.

3 Use the UP/DOWN arrows to select one of the following options: EZ Sound Rite, EZ Sound, Balance, Treble, Bass, Front Surround, or TV Speaker. Then press ENTER or the RIGHT arrow button.

4 Use the LEFT/RIGHT arrows to adjust the option to your preference (Balance, Treble, Bass).

Use the UP/DOWN arrows to select the option (EZ Sound Rite, EZ Sound, Front Surround, or TV Speaker)

5 Press EXIT to save and return to TV viewing or press the ENTER button to save and return to the previous menu.

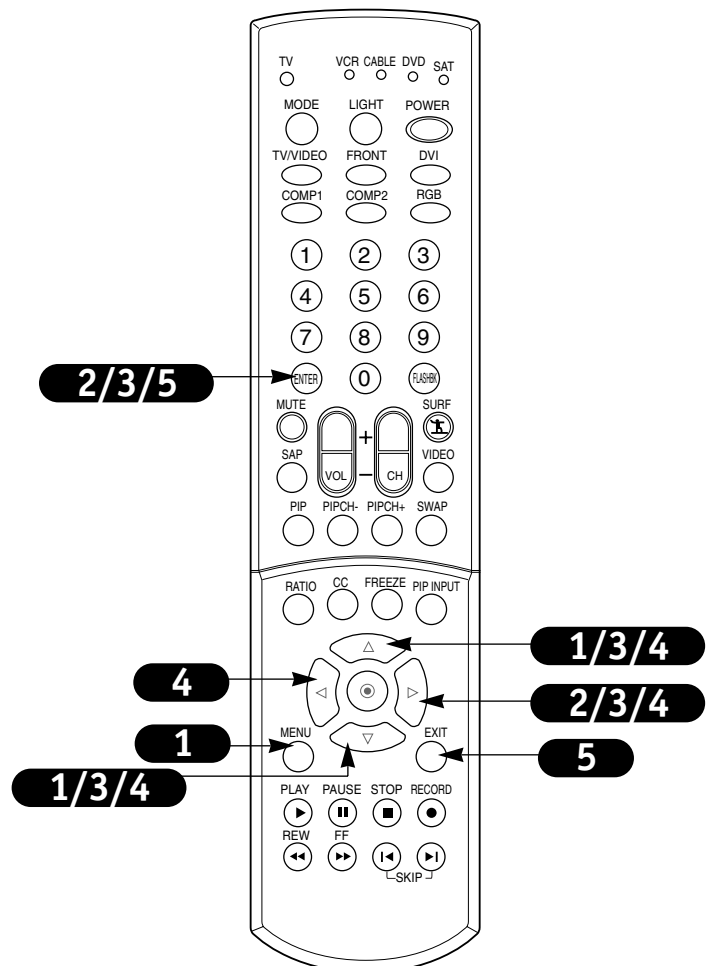

Audio Menu Options



- **EZ SoundRite** Scans for changes in sound level during commercials, then adjusts the sound to match the current audio level of the TV program you are watching.
- **EZ Sound** Chooses the sound options manually.
 - Off** Lets you adjust the Audio menu sound options manually.
 - Normal** Restores the sound levels to their original settings.
 - Stadium** Stresses high frequency sounds and front surround sound to create the sensation you would experience in a stadium.
 - News** Increases high frequency sounds to emphasize the human voice.
 - Music** Increases both high and low frequency sounds to stress the sounds of musical instruments.
 - Theater** Stresses both high and low frequency sounds, in addition to the front surround sound, to create the sensation you would experience in a theater.
- **Balance** Adjusts you adjust the left to right balance of the TV speakers.
- **Treble** Increases or decreases the higher frequency sounds from the TV speakers. Increases in treble, for example, make voice or string sounds stand out.
- **Bass** Increases or decreases the lower frequency sounds from the TV speakers.
- **Front Surround** Increases the front surround sound to create more open and expanded sound.
- **TV Speaker** Allows you to toggle the TV internal speakers On, Center or off. If you want to use your external hi-fi stereo system, turn off the internal TV speakers. However, you may use the internal TV speakers as a center speaker to create a surround effect.
(Center speaker is not available using Ant/Cable for main picture source.)

Auto Clock Setup

Sets the time automatically from the PBS broadcast signal.

The PBS channel signal includes information for the correct time.

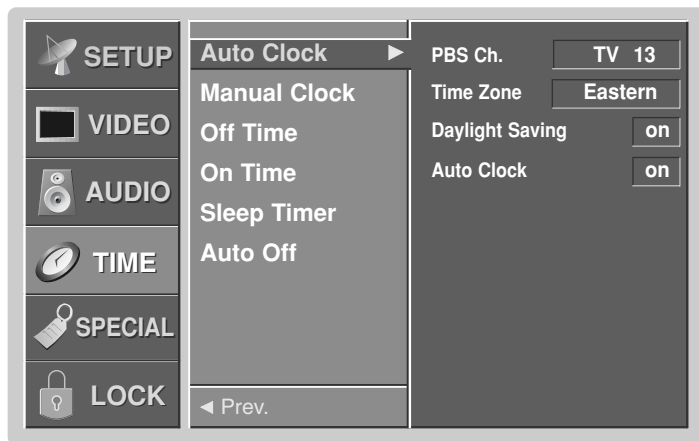

1 Press the MENU button on the remote control, then use the UP/DOWN arrow button to select the Time menu.

2 Press ENTER or the RIGHT arrow button to activate the Time menu.

3 Use the UP/DOWN arrow button to choose Auto Clock, then press ENTER or the RIGHT arrow button to activate the Auto Clock option. Use the LEFT/RIGHT arrow button to make your auto clock selection.

- Use the UP/DOWN arrow button to set the PBS channel.
- Time Zone - Lets you select the time zone for your viewing area.
- Daylight Savings - Lets you set Daylight Savings Auto, On or Off, depending on whether or not your viewing area observes Daylight Savings.
- If you select Auto Clock, use the UP/DOWN arrow button to choose On or Off.

4 Press EXIT to save and return to TV viewing or press the ENTER button to save and return to the previous menu.

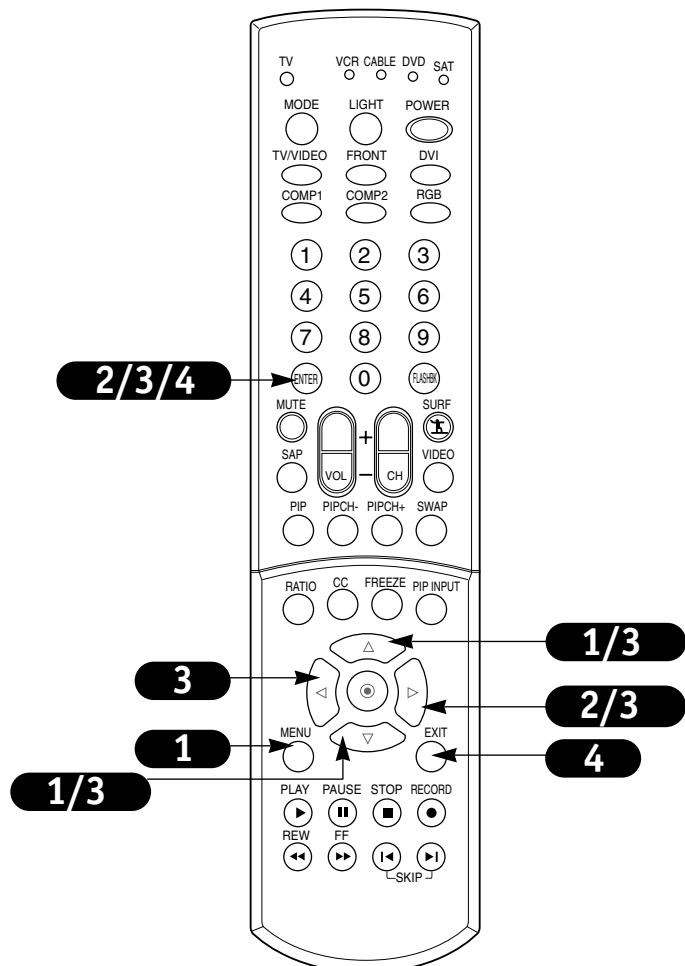

Manual Clock Setup

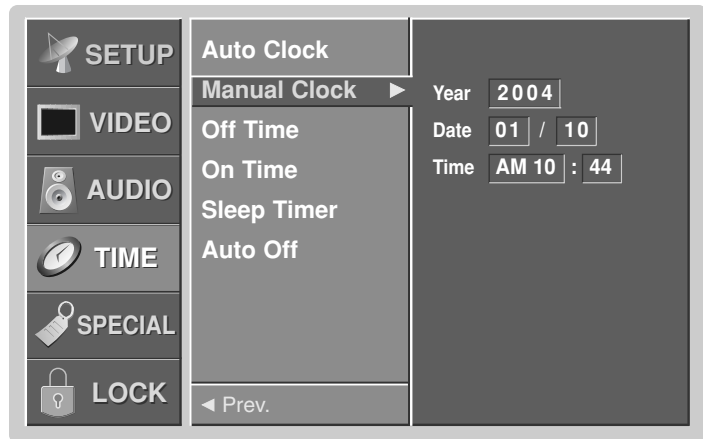

1

Press the MENU button on the remote control, then use the UP/DOWN arrow button to select the Time menu.

2

Press ENTER or the RIGHT arrow button to activate the Time menu.

3

Use the UP/DOWN arrow button to choose Manual Clock, then press the RIGHT arrow to activate the Manual Clock menu.

4

Use the LEFT/RIGHT arrows button to make your Manual Clock selection. Your choices are: Year, Date and Time.

5

Use the UP/DOWN arrows to set the Year, Date, and Time.

6

Press EXIT to save and return to TV viewing or press the ENTER button to save and return to the previous menu.

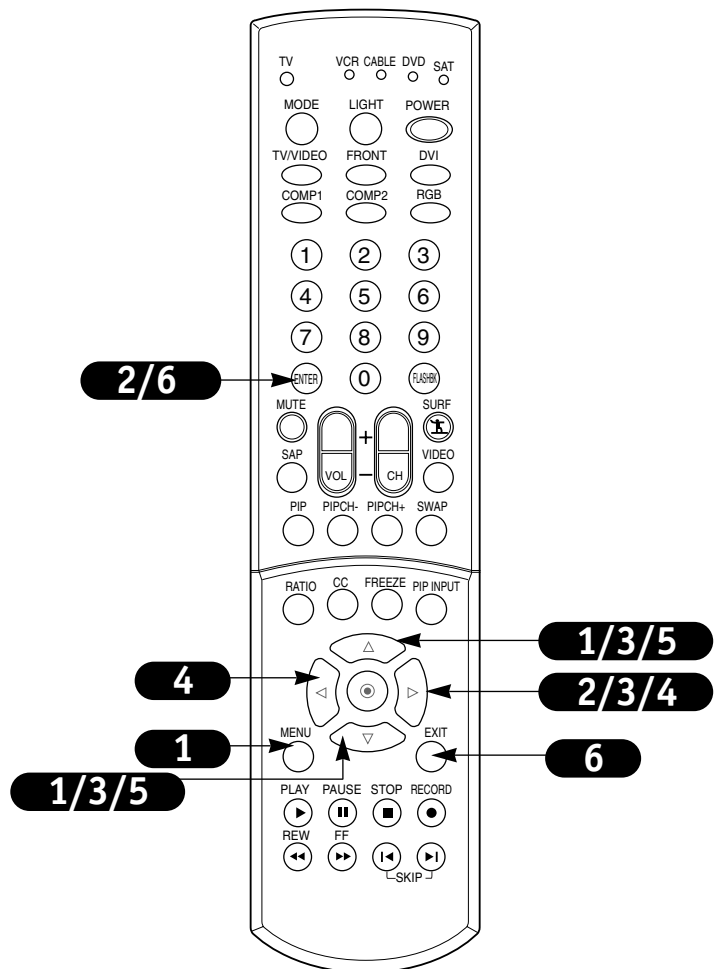

TV Turn Off Time Setup

Lets you set an automatic daily turn off time for your TV.

Off Time function overrides On Time function if they are both set to the same time.

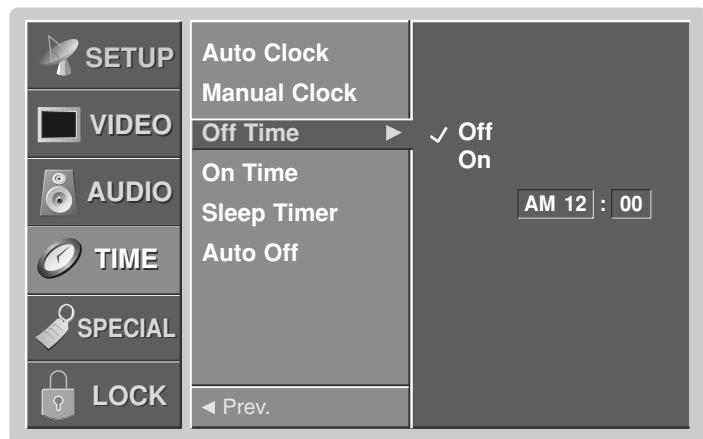

- 1** Press the MENU button on the remote control, then use the UP/DOWN arrow button to select the Time menu.
- 2** Press ENTER or the RIGHT arrow button to activate the Time menu.
- 3** Use the UP/DOWN arrows to choose Off Time then press the RIGHT arrow to activate Off Time.
- 4** Use the UP/DOWN arrows to choose On.
- 5** Use the LEFT/RIGHT arrows to select each Off Time option.
- 6** Use the UP/DOWN arrows to set the hours and then set the minutes.
- 7** Press EXIT to save and return to TV viewing, or press the ENTER button to save and return to the previous menu.



To cancel Off Time function, use the UP/DOWN arrow button to select Off in step 4.

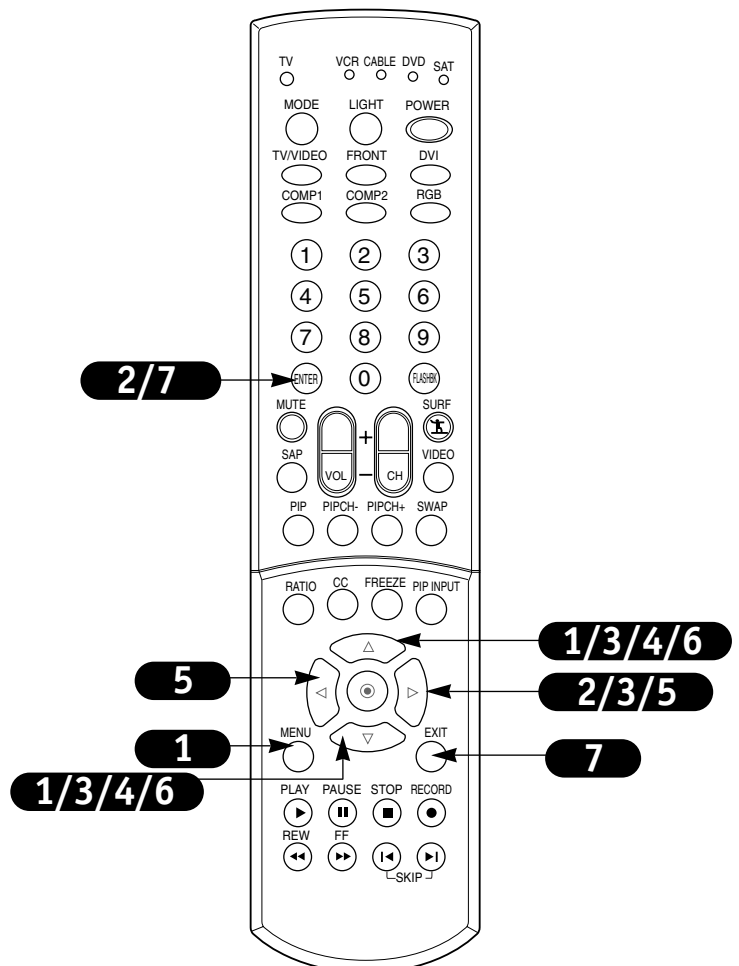

TV Turn On Time Setup

Time function operates only if current time is set.

Unless a button is pressed within two hours after the TV is turned on by the On time function, the TV will automatically turn itself off.

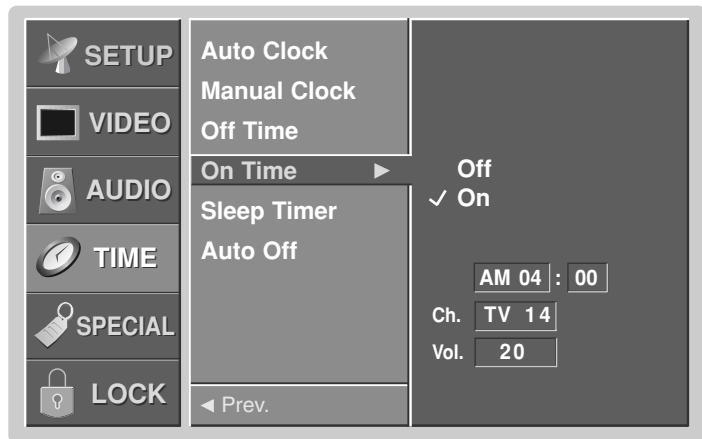

- 1** Press the MENU button on the remote control, then use the UP/DOWN arrow button to select the Time menu.
- 2** Press ENTER or the RIGHT arrow to activate the Time menu.
- 3** Use the UP/DOWN arrows to choose On Time, then press the RIGHT arrow to activate the On Time menu.
- 4** Use the UP/DOWN arrows to choose On.
- 5** Use the LEFT/RIGHT arrows to select in turn the On Time menu options: Time, Channel, and Volume.
- 6** Use the UP/DOWN arrows to set Time, Channel, and Volume at turn on.
- 7** Press EXIT to save and return to TV viewing, or press the ENTER button to save and return to the previous menu.



To cancel On Time function, use the UP/DOWN arrow button to select Off in step 4.

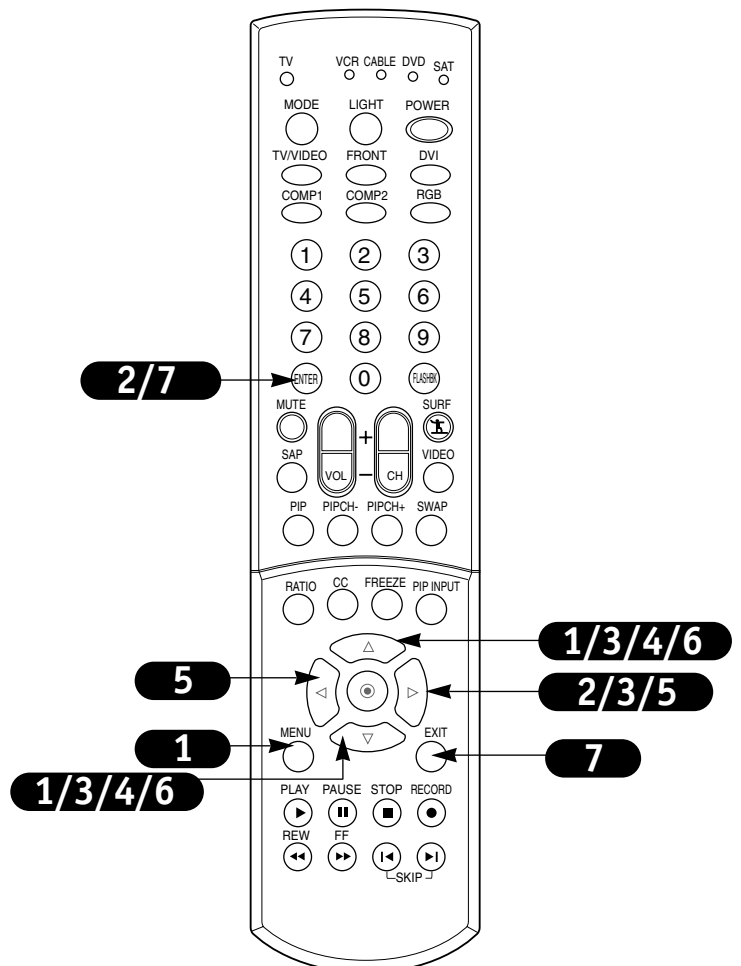

Sleep Timer Setup

Select a preset time to turn your TV off automatically.



- 1** Press the MENU button on the remote control, then use the UP/DOWN arrow button to select the Time menu.
- 2** Press ENTER or the RIGHT arrow button to activate the Time menu.
- 3** Use the UP/DOWN arrows to choose Sleep Timer then press the RIGHT arrow to access the Sleep Timer menu.
- 4** Use the UP/DOWN arrows to choose a preset turn off time.
- 5** Press EXIT to save and return to TV viewing, or press the ENTER button to save and return to the previous menu.



If you turn the TV off after setting sleep timer, the setting will be erased. Set it again if necessary.

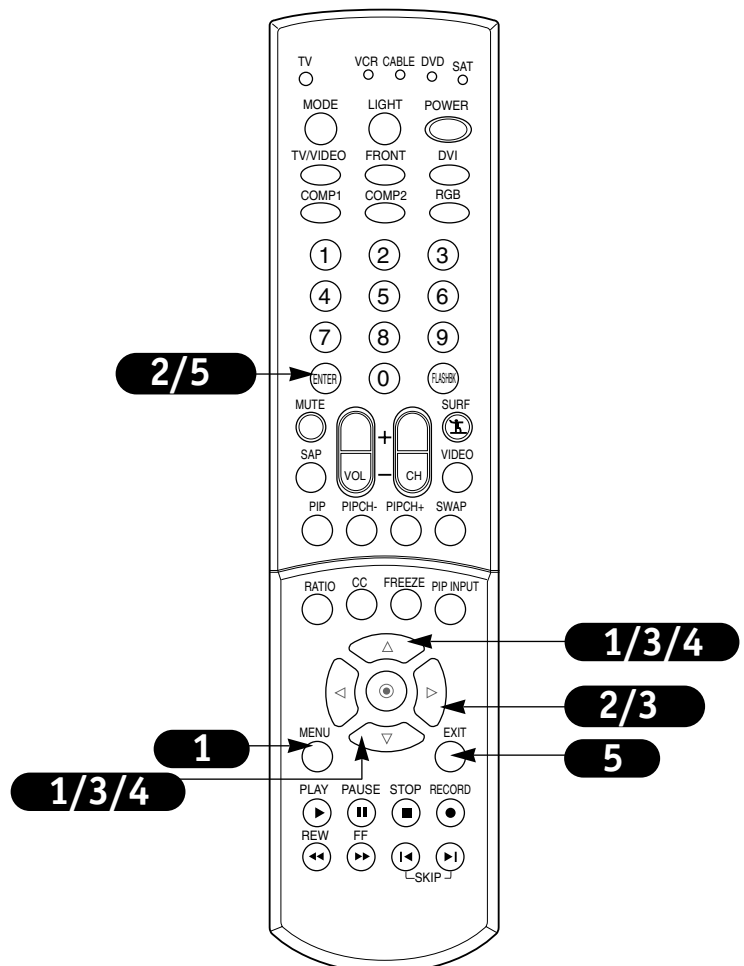

Auto Off

If there is no input signal, the TV can be set up to switch to standby mode automatically after 10 minutes.



- 1** Press the MENU button on the remote control, then use the UP/DOWN arrow button to select the Time menu.
- 2** Press the RIGHT arrow button to go to the Time menu.
- 3** Use the UP/DOWN arrow button to choose Auto Off then press the RIGHT arrow button to access the Auto Off menu.
- 4** Use the UP/DOWN arrows to choose On or Off.
- 5** Press EXIT button to save and return to TV viewing, or press the MENU button to save and return to the previous menu.

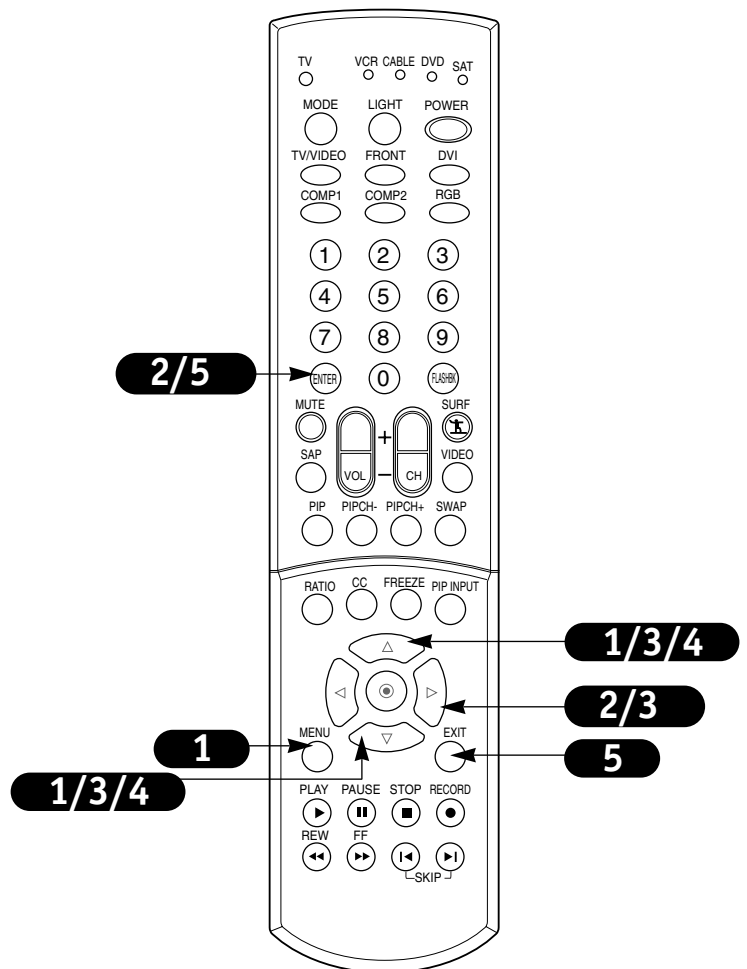

Aspect Ratio

- 1** Press the MENU button on the remote control, then use the UP/DOWN arrow button to select the Special menu. Or press RATIO button to instantly access the Aspect Ratio menu.
- 2** Press ENTER or the RIGHT arrow button to activate the Special menu.
- 3** Use the UP/DOWN arrows to choose Aspect Ratio.
- 4** Press ENTER or the RIGHT arrow button to move into the Aspect Ratio selection menu. Use the UP/DOWN arrow buttons to select the right ratio for your viewing environment:

- **4:3** - Choose when you want to view a picture with an original 4:3 aspect ratio, with black bars appearing at both the left and right sides.
- **16:9** - Choose when you want to adjust the picture horizontally, in a linear proportion to fill the entire screen. (Useful for viewing 4:3 formatted DVDs.)
- **Horizon** - Choose when you want to adjust the picture in a non-linear proportion, that is, more enlarged at both sides, to create a spectacular view.
- **Zoom1** - Choose when you want to view the picture without any alteration. However, the top and bottom portions of the picture will be cropped.
- **Zoom2** - Choose when you want the picture to be altered, both horizontally extended and vertically cropped. The picture taking a halfway trade off between alteration and screen coverage.

- 5** Press EXIT to save and return to TV viewing or press the ENTER button to save and return to the previous menu.

 For RGB-PC source, you can select either 4:3 or 16:9 aspect ratios.

For RGB-DTV (720p, 1080i) or Component 1-2 (720p, 1080i) sources,, you can select either 4:3, 16:9 or Zoom1-2 aspect ratios.

 Aspect ratio is changed to 16:9 automatically for 720p or 1080i formats from component input1/2, RGB, or DVI sources.

 After connecting external equipment to the TV, don't display a still picture for a long time on the screen. Doing so may damage the TV screen.

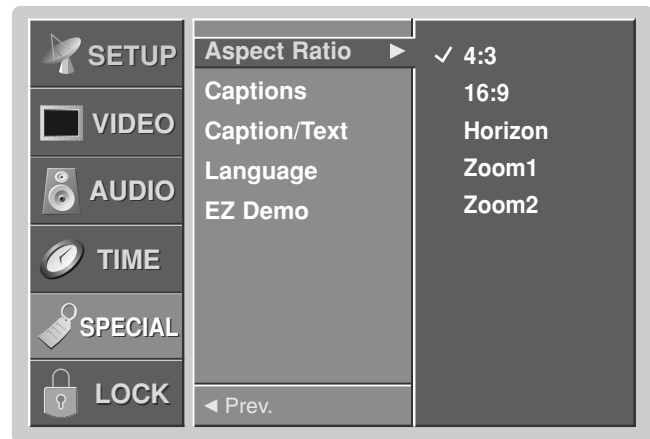

Lets you choose the way that an analog picture with a 4:3 aspect ratio is displayed on your TV 16:9 aspect ratio TV screen. When you receive an analog picture with a 4:3 aspect ratio on your 16:9 TV, you need to specify how the picture is to be displayed according to your preference.

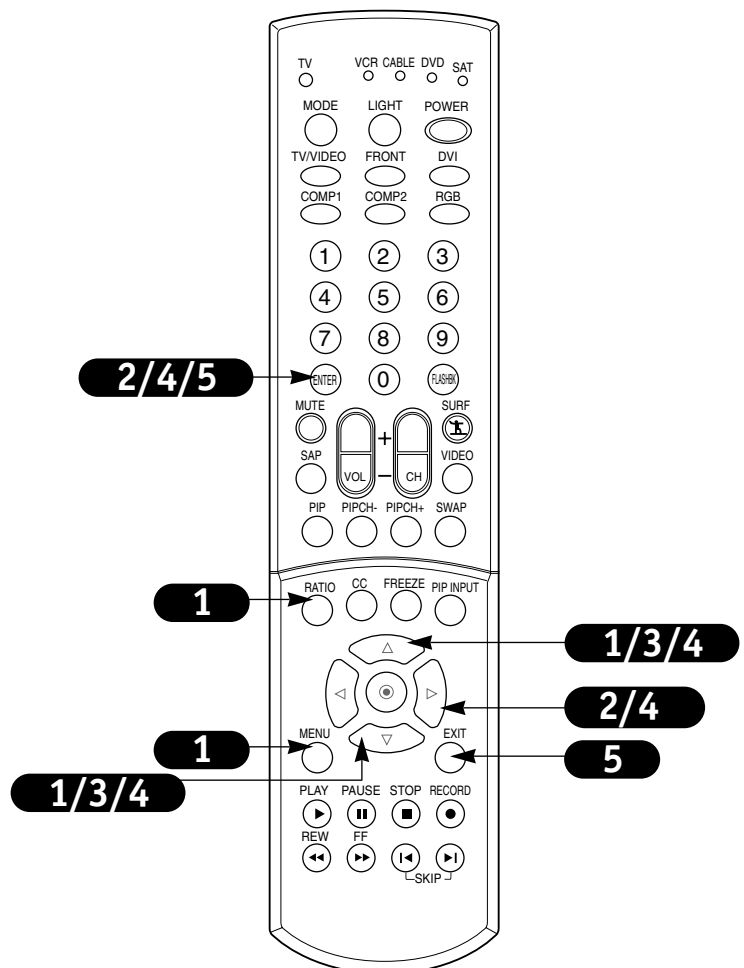

Captions Setup

Using the menu

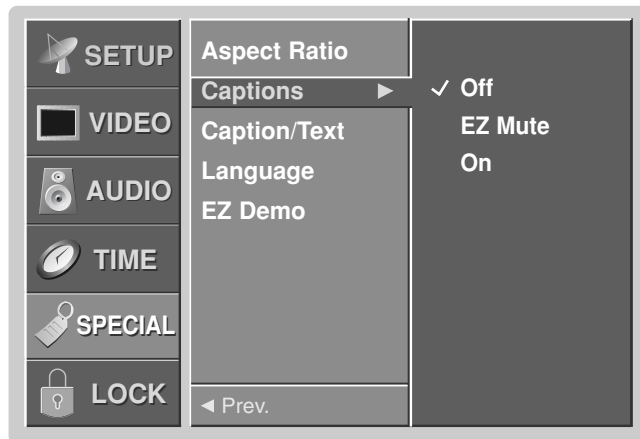

- 1** Press the MENU button on the remote control, then use the UP/DOWN arrow button to select the Special menu.
- 2** Press ENTER or the RIGHT arrow button to activate the Special menu.
- 3** Use the UP/DOWN arrows to choose Captions, then press ENTER or the Right arrow button.
- 4** Use the UP/DOWN arrow buttons to make your caption selection. Your choices are: Off, EZ Mute, and On.
- 5** Press EXIT to save and return to TV viewing or press the ENTER button to save and return to the previous menu.

Using the CC button

- 1** Use the CC button to select captions.
Each press of the CC button changes the caption option; Off, EZ Mute, and On. Captions Setup is complete. EZ Mute shows the selected captions option (if available on program) when the TV sound is muted.
- 2** Press EXIT to save and return to TV viewing.

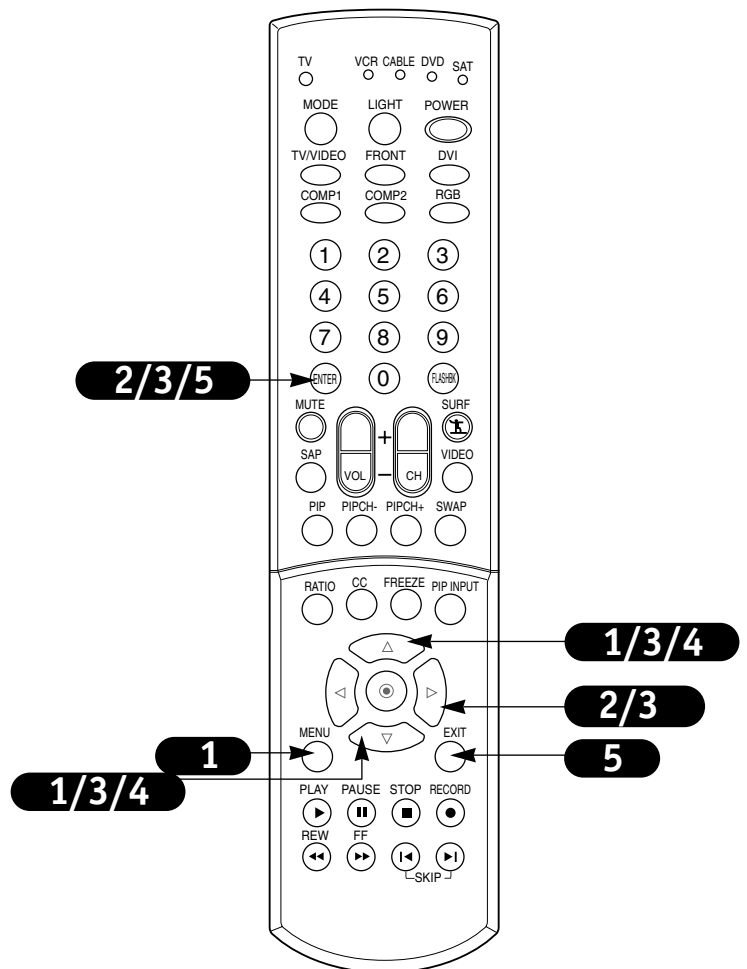

Caption/Text Mode Selection

Select a closed caption mode for displaying captioning information when provided on the program.

Captions displays information at any position on the screen usually the program's dialog.

Text displays information, usually at the bottom position and is used for a data service, generally not program related.

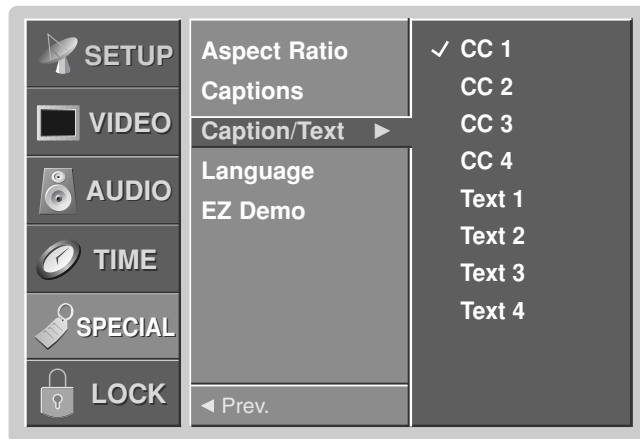

- 1** Press the MENU button on the remote control, then use the UP/DOWN arrow button to select the Special menu.
- 2** Press ENTER or the RIGHT arrow button to activate the Special menu.
- 3** Use the UP/DOWN arrows to choose Caption/Text, then press ENTER or the Right arrow button.
- 4** Use the UP/DOWN arrow buttons to make your caption selection. Your choices are: CC 1, CC 2, CC 3, CC 4, Text 1, Text 2, Text 3, or Text 4.
- 5** Press EXIT to save and return to TV viewing or press the ENTER button to save and return to the previous menu.

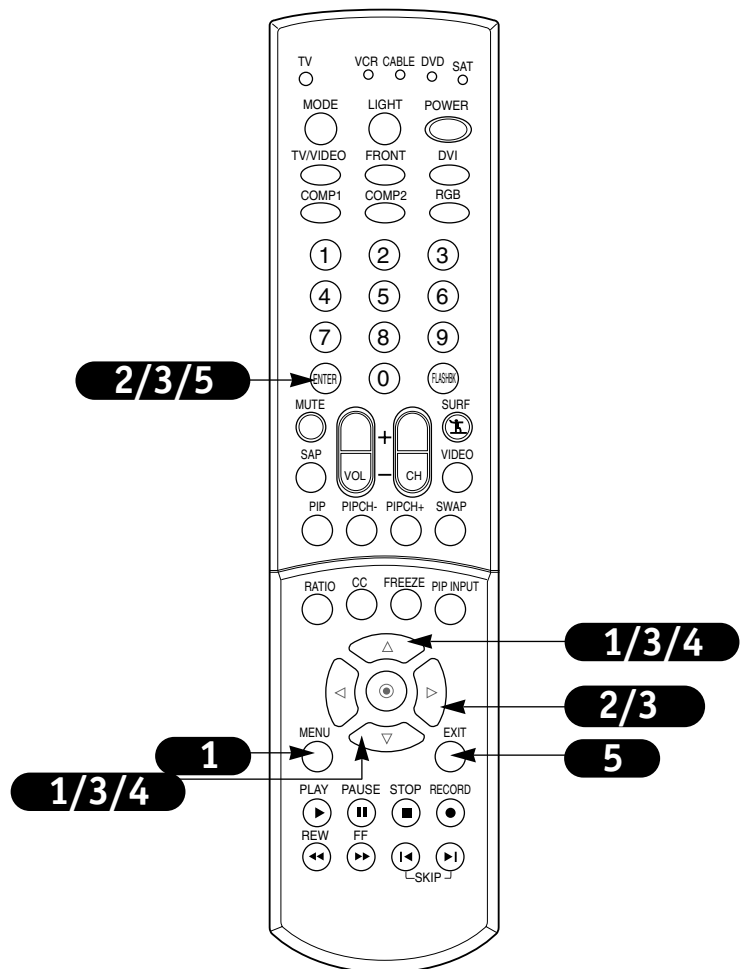

On-Screen Menus Language

Select your preferred language for the menus: English, Spanish, or French.



- 1** Press the MENU button on the remote control, then use the UP/DOWN arrow button to select the Special menu.
- 2** Press ENTER or the RIGHT arrow button to activate the Special menu.
- 3** Use the UP/DOWN arrows to choose Language.
- 4** Press ENTER or the RIGHT arrow button to move into the Language selection menu. Use the UP/DOWN arrow button to select the language you wish to use for your on-screen menus.
- 5** Press EXIT to save and return to TV viewing or press the ENTER button to save and return to the previous menu.

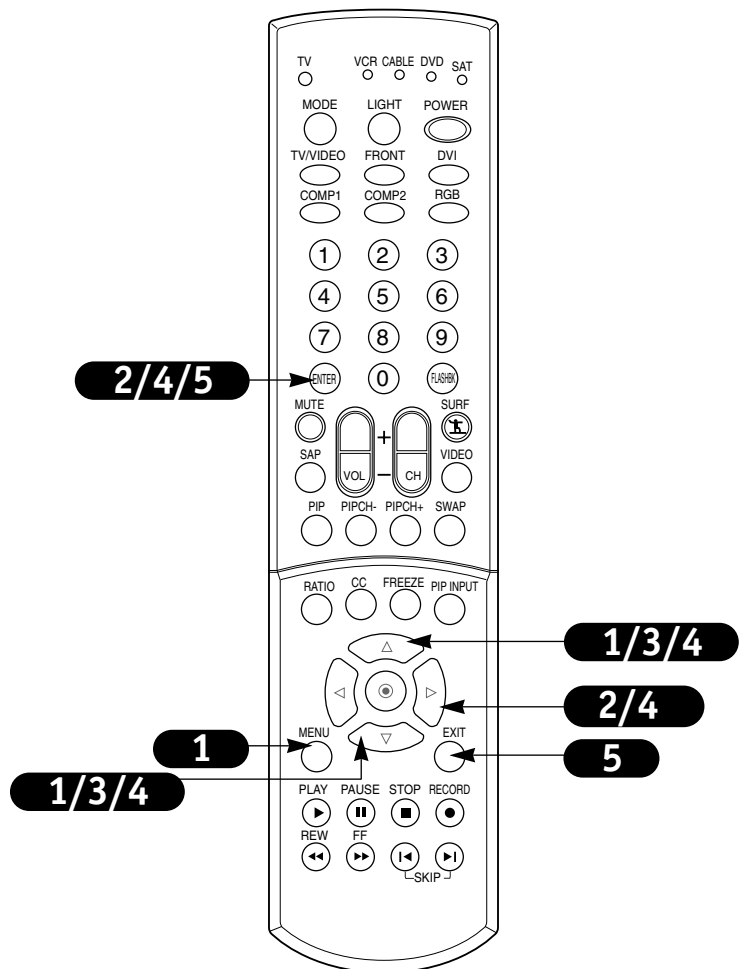

EZ Demo (Menu Review)

Use EZ Demo to scan the features and menu options available on your TV.



- 1** Press the MENU button on the remote control, then use the UP/DOWN arrow button to select the Special menu.
- 2** Press ENTER or the RIGHT arrow button to activate the Special menu.
- 3** Use the UP/DOWN arrows to choose EZ Demo, then press ENTER or the RIGHT arrow button to activate EZ Demo.
- 4** Press EXIT button on the remote to cancel EZ Demo.

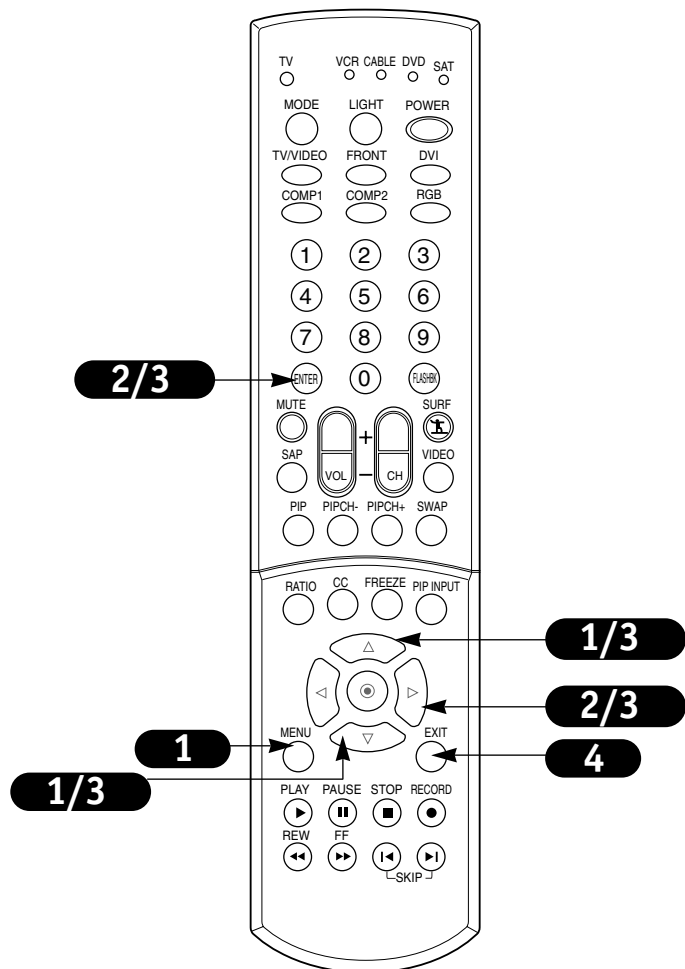

Parental Lock Setup

Lets you set up blocking schemes to block specific channels, ratings and external sources.

A password is required to gain access to this menu if the Lock System is active.

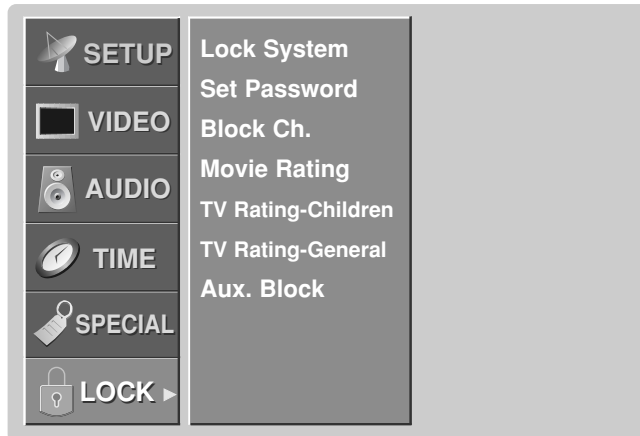

1 Press the MENU button on the remote control, then use the UP/DOWN arrow button to select the Lock Menu.

2 Press ENTER or the RIGHT arrow button to access the Lock Menu.

3 See the next page for more details on your blocking options.

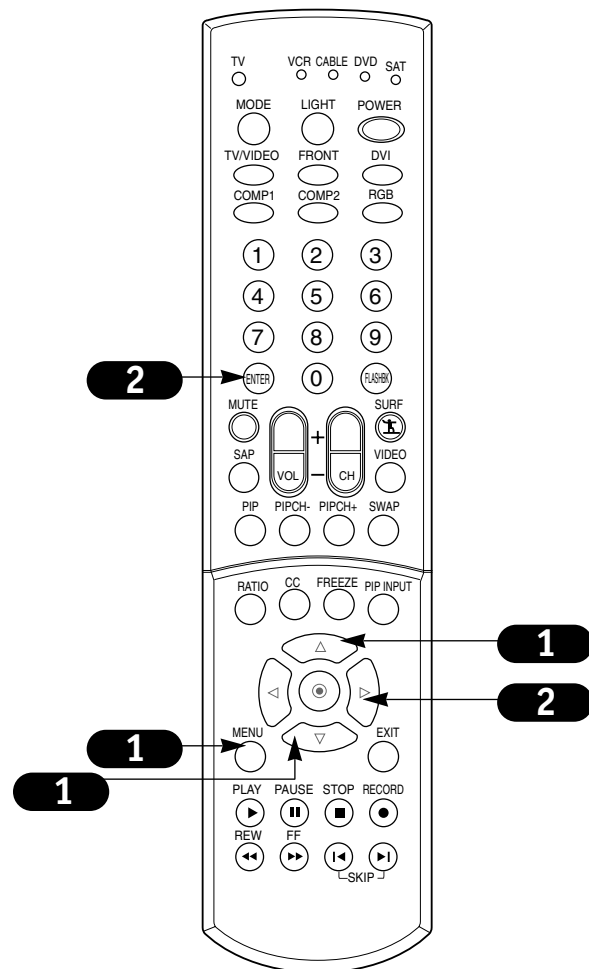

Parental Lock Setup (Contd.)

4

Use the UP/DOWN arrows to choose from the following Lock Menu options.

- **Lock System:** Activates or disables the blocking scheme you set up previously.
- **Set Password:** Changes the password by keying in a new password twice.
- **Movie Rating:** Blocks movies according to the movie ratings limit, so children cannot view certain movies. You can set the ratings limit by blocking out all the movies with the ratings above a specified level. Keep in mind that the movie ratings limit only applies to movie shown on TV, not TV programs, such as soap operas.
- **TV Rating-Children:** Keeps children from watching certain TV programs among only the programs intended for children, according to the ratings limit. This rating does not apply to other TV programs. Unless you block certain TV programs intended for mature audiences in the TV Rating - General menu, your children may view those programs.
- **TV Rating-General:** Blocks certain TV programs that you and your family do not want to watch, based on the ratings.
- **Block Ch.:** Blocks any channels that you do not want to watch or that you do not want your children to watch.
- **Aux. Block:** Enables you to select a source for blocking among the source devices you have hooked up.



If you forget your password, enter the number, 7777 to release the lock mode.

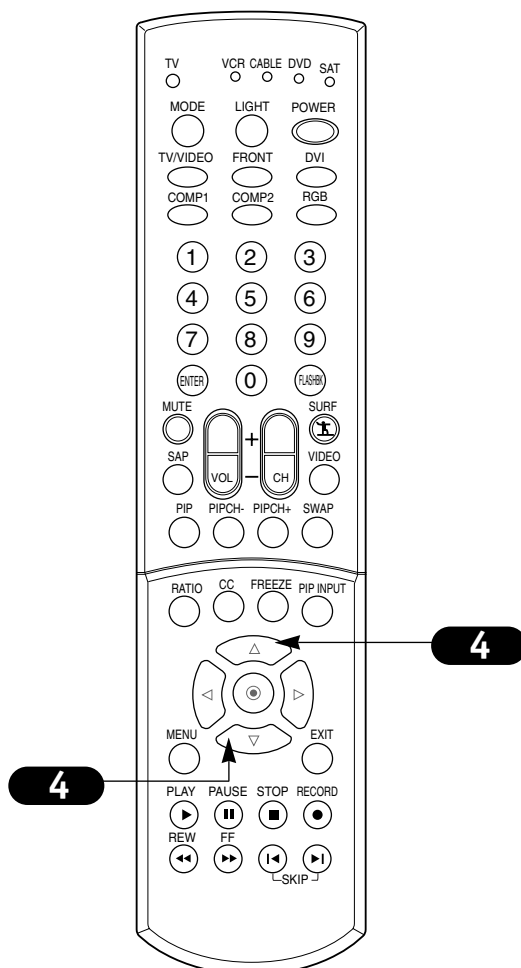
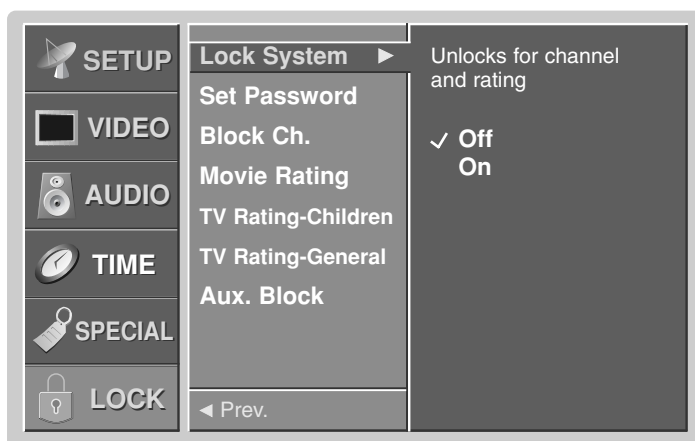

Parental Lock (Ratings Overview)

Parental Lock Rating Descriptions

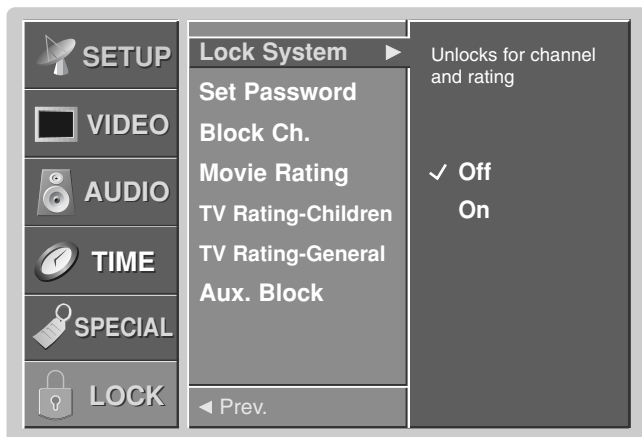

TV-Y7 (Children 7 Years & Older): Program is designed for children age 7 and above.

TV-G (General Audience): Most parents would find this program suitable for all ages.

TV-PG (Parental Guidance Suggested): Program contains material that parents may find unsuitable for younger children.

TV-14 (Parents Strongly Cautioned): Program contains some material that many parents would find unsuitable for children under 14 years of age.

TV-MA (Mature Audience Only): Program is specifically designed to be viewed by adults and therefore may be unsuitable for children under 17.

G (General Audience): All ages admitted.

PG (Parental Guidance Suggested): Some program content may not be suitable for children.

PG-13 (Parents strongly cautioned): Some program content may not be appropriate for children under 13.

R (Restricted): Children under 17 requires accompanying parent or adult guardian.

NC-17: No one 17 and under admitted.

TV-Y (All Children): Program is determined to be appropriate for all children.

X: Adult only.

Blocking Off: Permits all programs.

Programming the Remote

The remote control for your HD receiver is a multi-brand or universal remote control that can be programmed to operate most remote-controllable devices of other manufacturers.

Note: The remote control may not be able to control all models of other brands.

- 1** Test your remote control.
To find out whether your remote control can operate the device without programming, turn on the device such as a the VCR and press the corresponding mode button (VCR) on the remote control while pointing at the device. Test the **POWER** and **CH +/-** buttons to see if the device responds properly. If not, the remote requires programming to operate the device.
- 2** Turn on the device to be programmed. Then press the corresponding mode button on the remote control.
- 3** Press the **POWER** button and the **MUTE** button simultaneously. Now the remote control is ready to program the code for the corresponding device.
- 4** There are two ways to find the right code for the device.
 - A. If you press the **CH +/-** buttons repeatedly, the codes will change one at a time. Press the **POWER** button after each code change. If the right code is found, the device will turn off.
 - B. Enter a code number using the number buttons on the remote. The right code numbers for the corresponding component can be found on the following pages. Again, if the code is correct, the device will turn off.
- 5** Press the **EXIT** button to store the program.
- 6** Test the remote control functions to see if the device responds properly. If not, repeat from step 2.

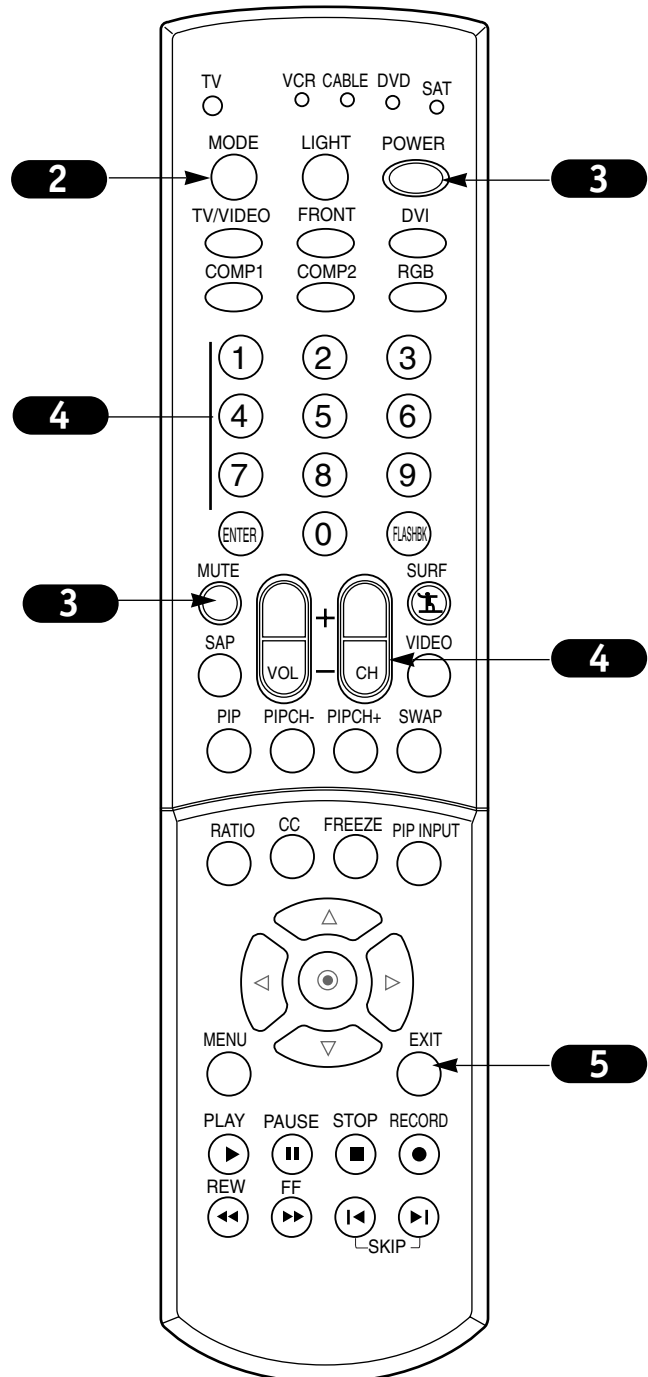

Programming Codes: TVs

TVs

Brand	Codes	Brand	Codes	Brand	Codes	Brand	Codes
A MARK	112 143	GOLDSTAR	004 102 106		019 024 040	Sharp	004 014 019
ADMIRAL	072 081 161		110 112 113		056 130 132		022 028 029
AKAI	006 146		116 119 122	NIKEI	134		081 143 170
AMPRO	073 167		127 137 143	ONKING	043		175
AMSTRAD	052	HALL MARK	004 116	ONWA	043	SIEMENS	088
ANAM	043 054 056	HITACHI	004 006 009	OPTONICA	019 081	SIGNATURE	072
	080 104 108		010 011 012	PANASONIC	034 056 080	SONY	041 070 079
	112 115 118		023 041 075		092 164		085 126 139
	121 131		143 158 163	PHILCO	003 004 006	SOUNDESIGN	003 004 028
AOC	004 006 058		166		024 043 056		043 116
	112	INFINITY	164		059 060 063	SPECTRICON	112
BLAUPUNKT	088	INKEL	129		064 127 143	SSS	004 043
CANDLE	002 003 004	JBL	164		164	SUPRE MACY	002
	006	JCPENNY	004 006 008	PHILIPS	003 004 005	SYLVANIA	003 004 006
CAPEHART	058		009 024 030		006 038 059		044 059 060
CETRONIC	043		065 101 143		070 093 143		063 064 116
CITIZEN	002 003 004		156 160		160 164		127 140 160
	006 043 101	JENSEN	013	PIONEER	006 018 023		164
	103 143	JVC	034 038 070		025 027 116	TANDY	081
CLASSIC	043		083 145		135 176	TATUNG	056 062
CONCERTO	004	KEC	043	PORTLAND	004 143	TECHNICS	034 080 084
CONTEC	039 043 050	KENWOOD	006 070	PROSCAN	144 160 161	TECHWOOD	004
	051	KLOSS	002 059		165 167	TEKNIKA	002 003 004
CORONADO	143	KMC	143	PROTON	004 058 116		006 024 028
CRAIG	043 054	KTV	006 043 143		131 143 171		031 043 072
CROWN	043 143		154		173		077 101 103
CURTIS MATHES	004 006 101	LG	255	QUASAR	034 056 092		143
	116 143	LODGENET	072	RADIO SHACK	019 043 047	TELEFUNKEN	037 046 086
CXC	043	LOGIK	072		116 127 143		087
DAEWOO	004 016 017	LUXMAN	004	RCA	004 006 023	TELERENT	072
	043 044 055	LXI	007 015 052		024 056 065	TERA	172
	071 076 103		081 160 164		074 144 152	TMK	004 116
	107 111 114		166		156 160 161	TOSHIBA	007 015 030
	117 120 123	MAGNAVOX	003 004 006		165		040 051 062
	125 127 128		022 059 060	REALISTIC	007 019 043		101 138
	136 143		061 063 064		047	TOTEVISION	143
DAYTRON	004 116 143		127 143 160	ROCTEC	186	UNIVERSAL	008 009
DYNASTY	043		164	RUNCO	168 169	VIDEO CONCEPTS	146
DYNATECH	062	MARANTZ	006 077 164	SAMPO	004 006 058	VIDIKRON	174
ELECTROHOME	024 077 143	MATSUI	164		116	VIDTECH	004 116
EMERSON	004 005 006	MEMOREX	004 007 072	SAMSUNG	004 050 089	WARDS	004 008 009
	028 043 047		116		101 105 113		019 028 060
	048 050 051	METZ	088		116 127 133		061 063 064
	096 116 143	MGA	004 006 024		137 143 160		072 074 116
	151 153 154		028 042 049	SANYO	007 020 021		143 164
	155		077 116		033 039 053	YAMAHA	004 006
FISHER	007 057	MINERVA	088		057 082 166	YORK	004 116
FUNAI	028 043	MITSUBISHI	004 006 024	SCOTT	004 028 043	YUPITERU	043
FUTURETECH	043		028 040 042		048 116 143	ZENITH	001 072 073
GE	004 006 008		109 116 124	SEARS	004 007 015		095 103 157
	009 034 056		146		028 030 057	ZONDA	112
	073 074 091	MTC	004 006 062		082 094 101		
	116 130 144		101		116 143 160		
	155 160 161	NAD	015 025				
	165	NEC	006 007 016				

Programming Codes: VCRs

VCRs

Brand	Codes	Brand	Codes	Brand	Codes	Brands	Codes
AIWA	034		055 060 130		034 040 041	TOTEVISION	040 101
AKAI	016 043 046		150 152		062 063 107	UNITECH	040
	124 125 146	KENWOOD	014 034 039		109 140 144	VECTOR RESEARCH	012
AMPRO	072		043 047 048		145 147	VICTOR	048
ANAM	031 033 103	LG	255	REALISTIC	003 008 010	VIDEO CONCEPTS	012 034 046
AUDIO DYNAMICS	012 023 039	LLOYD	034		014 031 033	VIDEOSONIC	040
	043	LXI	003 009 013		034 040 053	WARDS	003 013 017
BROKSONIC	035 037 129		014 017 034		054 101		024 031 033
CANON	028 031 033		101 106	RICO	058		034 040 053
CAPEHART	108	MAGIN	040	RUNCO	148		054 131
CRAIG	003 040 135	MAGNAVOX	031 033 034	SALORA	014	YAMAHA	012 034 039
CURTIS MATHES	031 033 041		041 067 068	SAMSUNG	032 040 102		043
DAEWOO	005 007 010	MARANTZ	012 031 033		104 105 107	ZENITH	001 034 048
	064 065 108		067 069		109 112 113		056 058 072
	110 111 112	MARTA	101		115 120 122		080 101
	116 117 119	MATSUI	027 030		125		
DAYTRON	108	MEI	031 033	SANSUI	022 043 048		
DBX	012 023 039	MEMOREX	003 010 014		135		
	043		031 033 034	SANYO	003 007 010		
DYNATECH	034 053		053 072 101		014 102 134		
ELECTROHOME	059		102 134 139	SCOTT	017 037 112		
EMERSON	006 017 025	MGA	045 046 059		129 131		
	027 029 031	MINOLTA	013 020	SEARS	003 008 009		
	034 035 036	MITSUBISHI	013 020 045		010 013 014		
	037 046 101		046 049 051		017 020 031		
	129 131 138		059 061 151		042 073 081		
	153	MTC	034 040		101		
FISHER	003 008 009	MULTITECH	024 034	SHARP	031 054 149		
	010	NEC	012 023 039	SHINTOM	024		
FUNAI	034		043 048	SONY	003 009 031		
GE	031 033 063	NORDMENDE	043		052 056 057		
	072 107 109	OPTONICA	053 054		058 076 077		
	144 147	PANASONIC	066 070 074		078 149		
GO VIDEO	132 136		083 133 140	SOUNDESIGN	034		
GOLDSTAR	012 013 020		145	STS	013		
	101 106 114	PENTAX	013 020 031	SYLVANIA	031 033 034		
	123		033 063		059 067		
HARMAN KARDON	012 045	PHILCO	031 034 067	SYMPHONIC	034		
HITACHI	004 018 026	PHILIPS	031 033 034	TANDY	010 034		
	034 043 063		054 067 071	TATUNG	039 043		
	137 150		101	TEAC	034 039 043		
INSTANTREPLAY	031 033	PILOT	101	TECHNICS	031 033 070		
JCL	031 033	PIONEER	013 021 048	TEKNIKA	019 031 033		
JCPENNY	012 013 015	PORTLAND	108		034 101		
	033 040 066	PULSAR	072	THOMAS	034		
	101	QUARTZ	011 014	TMK	006		
JENSEN	043	QUASAR	033 066 075	TOSHIBA	008 013 042		
JVC	012 031 033		145		047 059 082		
	043 048 050	RCA	013 020 033		112 131		

Programming Codes: SAT/DVDs

SAT

Brand	Codes	Brand	Codes	Brand	Codes	Brand	Codes
ALPHASTAR DSR	123		027 133 134	PERSONAL CABLE	117	VIEWSTAR	115
AMPLICA	050	GENERAL INSTRUMENT	003 004 016	PHILIPS	071	WINEGARD	128 146
BIRDVIEW	051 126 129		029 031 059	PICO	105	ZENITH	001 081 082
BSR	053		101	PRESIDENT	019 102		083 084 091
CAPETRONICS	053	HITACHI	139 140	PRIMESTAR	030 110 111		120
CHANNEL MASTER	013 014 015	HOUSTON TRACKER	033 037 039	PROSAT	072		
	018 036 055		051 057 104	RCA	066 106		
CHAPARRAL	008 009 012	HUGHES	068	REALISTIC	043 074		
	077	HYTEK	053	SAMSUNG	123		
CITOH	054	JANIEL	060 147	SATELLITE SERVICE CO	028 035 047		
CURTIS MATHES	050 145	JERROLD	061		057 085		
DRAKE	005 006 007	KATHREIN	108	SCIENTIFIC ATLANTA	032 138		
	010 011 052	LEGEND	057	SONY	103		
	112 116 141	LG	255	STARCAST	041		
DX ANTENNA	024 046 056	LUTRON	132	SUPER GUIDE	020 124 125		
	076	LUXOR	062 144	TEECOM	023 026 075		
ECHOSTAR	038 040 057	MACOM	010 059 063		087 088 090		
	058 093 094		064 065		107 130 137		
	095 096 097	MEMOREX	057	TOSHIBA	002 127		
	098 099 100	NEXTWAVE	028 124 125	UNIDEN	016 025 042		
	122	NORSAT	069 070		043 044 045		
ELECTRO HOME	089	PACE SKY SATELLITE	143		048 049 078		
EUROPLUS	114	PANASONIC	060 142		079 080 086		
FUJITSU	017 021 022	PANSAT	121		101 135 136		

DVD

Brand	Codes	Brand	Codes	Brand	Codes	Brand	Codes
APEX DIGITAL	022		025	PHILIPS	013	THOMPSON	005 006
DENON	020 014	MAGNAVOX	013	PIONEER	004 026	TOSHIBA	019 008
GE	005 006	MARANTZ	024	PROCEED	021	YAMAHA	009 018
GOLDSTAR	010 016 025	MITSUBISHI	002	PROSCAN	005 006	ZENITH	010 016 025
HARMAN KARDON	027	NAD	023	RCA	005 006		
JVC	012	ONKYO	008 017	SAMSUNG	011 015		
LG	001 010 016	PANASONIC	003 009	SONY	007		

Programming Codes: Cable Boxes

CATV

Brand	Codes	Brand	Codes	Brand	Codes	Brand	Codes
ABC	003 004 039		008 009 010	REGAL	049 050		032 035
	042 046 052		052 069 074	REGENCY	057	VIEWSTAR	012 015 018
	053	LG	255	REMBRANT	025		086 087 088
ANTRONIK	014	M-NET	037	RK	091		089
ARCHER	005 007 014	MACOM	033	SAMSUNG	030 068	ZENITH	001 060 093
	024	MAGNAVOX	010 012 064	SCIENTIFIC ATLANTA	003 011 041		
CABLE STAR	026		079		042 043 045		
CENTURION	092	MEMOREX	001		046		
CENTURY	007	MOVIE TIME	028 032	SHERITECH	022		
CITIZEN	007	NSC	015 028 038	SIGNAL	030		
COLOUR VOICE	065 090		071 073	SIGNATURE	052		
COMBANO	080 081	OAK	016 031 037	SL MARX	030		
COMTRONICS	019 030		053	SPRUCER	047 078		
DIAMOND	023	PANASONIC	044 047	STARCOM	002 004 008		
EAGLE	020 030 040	PARAGON	001		009		
EASTERN	057 062 066	PHILIPS	006 012 013	STARGATE	008 030		
ELECTRICORD	032		020 065 085	SYLVANIA	067		
GE	072		090	TADIRAN	030		
GEMINI	008 022 025	PIONEER	034 051 052	TANDY	017		
	054		063 076	TEXSCAN	029 067		
GI	052 074	POST NEWS WEEK	016	TOCOM	039 040 056		
GOLDEN CHANNEL	030	PRUCER	059	TOSHIBA	001		
HAMLIN	049 050 055	PTS	011 048 071	UNIKA	007 014 024		
HITACHI	052 055		072 073 074	UNITED CABLE	004 053		
HOSPITALITY	070 077	PULSAR	001	UNIVERSAL	005 007 014		
JERROLD	002 003 004	RCA	047		024 026 027		

Careful and regular cleaning can extend the amount of time you will have your new TV. Be sure to turn the power off and pull out the power cord before you begin any cleaning.

SCREEN CLEANING

1. Here's a great way to keep the dust off your screen for a while. Wet a soft cloth in a mixture of lukewarm water and a little fabric softener or dish washing detergent. Wring the cloth until it's almost dry, and then use it to wipe the screen.
2. Make sure the excess water is off the screen, and then let it air-dry before you turn on your TV.

CABINET CLEANING

1. Use a soft cloth with a mild soap solution to wipe the cabinet.
2. Rinse the cloth and wipe the cabinet again.
3. Let the cabinet air-dry before turning the TV on.

WOOD CABINETS

Use a quality wood cleaner and polish. This will protect the TV from dirt and dust, as well as keep the cabinet looking new.

EXTENDED ABSENCE



If you intend to leave your TV dormant for a long time (such as a vacation), it's a good idea to unplug the power cord to protect against possible damage from lightning or power surges. If you use an off-air antenna, you may also want to disconnect it from the back of your TV before leaving.

PICTURE INTERFERENCE

Even though you may be getting cable service, the signal may be weak, which means the quality of your picture may suffer due to other factors. If there are problems with the image on your TV, consult the Troubleshooting guide on the following pages. You may also want to contact your cable service provider to determine if the problem is from the cable service.

VIDEO GAMES AND OTHER FIXED-PATTERN DISPLAYS

If you use your TV to play video games or for other uses that have single, fixed images, such as a photo-CD player, you should avoid setting the Brightness level too high. If static images, like network identification patterns, are left on the screen for too long, they can leave a permanent impression on the TV screen. You can reduce the chance of this happening by limiting the amount of time you use the fixed-image display, and by reducing the contrast and brightness levels.



If you unplug your TV from a wall power outlet, you may have to reset the clock using the Time menu described earlier.

Troubleshooting

Some quick and easy tips to fixing problems yourself.

SYMPTOMS	SYMPTOMS POSSIBLE SOLUTIONS
Snowy picture and unclear sound.	<ul style="list-style-type: none">• Check your antenna connection or location.• Check your cable input.• Check to see if the TV/VCR button on your VCR has the TV selected.
Multiple images or 'ghost shadows.'	<ul style="list-style-type: none">• Check your antenna direction and/or location.• Check your cable input.• Make sure the cable from your antenna to your TV is properly connected.
Interference: Sharp lines across the screen and unclear sound.	<p><i>The following may cause image problems or distortion: Electrical appliances, powerful lights, cars, trucks; computers or portable phones; medical equipment</i></p> <ul style="list-style-type: none">• If possible increase the distance between your TV and the offending appliance. Or shut one of them off.
Normal picture but no sound.	<ul style="list-style-type: none">• Check sound level.• Make sure the TV sound is not muted.• Try another channel. The problem may be the broadcast, not your TV.• Are the Audio cables properly installed?• Are the wires for external speakers (if you have external speakers) properly installed?• Make sure your speakers are turned on in the Audio menu.• If your audio mode is set to SAP, that channel may not have an SAP program.
No picture and unclear sound.	<ul style="list-style-type: none">• Are you in TV or cable tuning mode, and should be in the other?• Make sure output channels on all A/V equipment are on the same channel (3 or 4).• Check that all connections are tight.
No picture and no sound.	<ul style="list-style-type: none">• Is the AC power cord plugged in?• Check that your AC power outlet works. (Test it by plugging in something else or try another outlet.)• Make sure your brightness and audio controls are set properly.• Try another channel. The problem may be with the broadcast.
No color, but the sound is O.K.	<ul style="list-style-type: none">• Check the color settings in the Video menu.• Try another channel. The problem may be with the broadcast.
Picture has a big black box on it, but the sound is O.K.	<ul style="list-style-type: none">• The Caption option may be in Text mode. Select Caption 1, or OFF in the Captions/Text menu.
Picture has two horizontal black bars, one on top and one on bottom.	<ul style="list-style-type: none">• Your program is in letterbox. This means that the shape of your TV is a square, but the program is a rectangle. Think of the bars as empty space the program doesn't fill; not picture that's blocked out. Because this format is a direct representation of film as you see it in the movies, you are actually seeing MORE of the program when you see those bars.
Missing Secret code	<ul style="list-style-type: none">• If you forget the secret code, press the remote control Button '7', '7', '7' and '7' when the display asks you to enter the secret code.

Troubleshooting (Contd.)

Remote control doesn't work.	<ul style="list-style-type: none">• Make sure the batteries are fresh and installed properly.
Menu options can't be changed or selected.	<ul style="list-style-type: none">• Try unplugging your TV for a few minutes, then plug it back in.
No picture or sound when any non-cable source is selected.	<ul style="list-style-type: none">• Check to see if the source equipment has been turned on.• Make sure that the connections are secure on the back of your TV and on the source equipment.
Weak or no Stereo Sound when using a stereo VCR.	<ul style="list-style-type: none">• Check to see if all the connections are secure.• Look in the Audio mode menu to see if all the settings are correct.• You are using channel 3 or 4 to view your VCR. No stereo sound is present under that decision.
The PIP inset is black or lacks contrast.	<ul style="list-style-type: none">• Check to be sure that the PIP source is turned on.• You might want to adjust the PIP picture settings under the PIP menu.• Check that all the wires are connected properly.• Check to see if your input source for PIP is set correctly.
The PIP inset is "snow" when the source is Antenna.	<ul style="list-style-type: none">• Look to see if the TV/VCR button on your VCR has the TV selected or change the PIP to another source.
Time is incorrect.	<ul style="list-style-type: none">• Reset clock manually.

Glossary

A list of definitions for some of the words found in this guide as they relate to these TVs.

75 OHM RF CABLE	The round cable that comes from an off-air antenna or cable service provider. Each end looks like a hex shaped nut with a wire sticking through the middle, and it screws onto the threaded jack on the back of your TV.
A/V CABLES	Audio/Video cables. Three cables - Right audio (red), Left audio (white), and Video (yellow). A/V cables are used for stereo playback of videocassettes and for higher quality picture and sound from other A/V devices.
A/V DEVICE	Any device that produces video or sound (VCR, DVD, cable box, satellite receiver, set-top box, or television).
ADD (SHOW)	This function lets you add new channels to the channel list in memory that you'll scroll through when using your remote.
AMPLIFIER	An external device that amplifies sound from a television, CD player, VCR, DVD or other A/V device.
ANALOG TV	Traditional method of representing a television signal as a replica (analog) of the original picture and sound.
ANTENNA	The physical receiver of television signals sent over the air. A large metal piece of equipment does not always have to be visible for your home to be using an antenna.
ASPECT RATIO	The ratio of the horizontal dimension to the vertical dimension of a picture. Standard television in the U.S. today is generally transmitted and displayed in a 4:3 aspect ratio. High-Definition television will normally be formatted in the wider 16:9 aspect ratio.
AUDIO CENTER MODE IN	Input jack provided for connecting external Dolby digital preamplifier output to the TV, to use as the center speaker channel and enhance your home theater setup.
CAPTIONS	A form of subtitling that writes out the dialog of a program on the screen.
COMPONENT INPUT (P_R P_B Y)	Series of input jacks provided for extremely accurate picture reproduction yielding a higher quality picture than standard video inputs.
DELETE (HIDE)	Removes channels that you don't watch from the channel list in memory.
DIGITAL TV	A new method of representing a television signal as a series of binary numbers (1s and 0s). This method allows for the signal to be manipulated to eliminate redundancy to dramatically increase picture and sound quality.
DOLBY DIGITAL	Dolby Digital Cinema Sound is made possible by a new digital coding technique called Dolby AC-3. Dolby AC-3 produces high-quality, 5.1 channel surround sound which is six discrete separate channels for a full range of sound. Each channel can carry a different signal simultaneously (front center, front left, front right, surround left, surround right and subwoofer).
DVD	Optical disc storage technology. Digital video disc player. A disc that contains movies etc. in digital format.
DVI INPUT	Digital video interface. Video multimedia standard for computer text and graphics. Port
DTV	Digital television source, (set-top box).
DTV FORMATS	
480I	Standard DTV format.
480p	Enhanced DTV format.
720p/1080i	(HDTV) High definition video formats.

Glossary (Contd.)

A list of definitions for some of the words found in this guide as they relate to these TVs.

HD-STB	High-definition set-top box.
INPUT	Refers to the jack that receives a signal into the TV, VCR or other A/V device.
JACK	A connection on the back of a TV, VCR, or any other A/V device. This includes the RF jacks and the Audio/Video jacks that are color-coded.
MODE	The mode determines the type of device (TV, VCR, Cable, Aux) that the remote is controlling; remote operating mode.
MONO SOUND	Mono (monaural) sound is one channel of sound. On more than one speaker all the speakers play the same audio.
OUTPUT	Refers to the jack that sends a signal out of a VCR, DVD, or other A/V device.
PC	A computer.
PIP	This is the most common way to refer to the Picture-in-Picture (PIP) feature.
PIP SNAPSHOT	Press FREEZE button to capture and freeze sub picture in PIP or split mode. Press PIP button to enter PIP mode from another channel. Press EXIT button to remove PIP from the screen.
POP (PICTURE-OUT-OF-PICTURE)	Additional PIP-type viewing feature.
RGB INPUT	Red, green, blue. 15-pin input provided for computers or set-top boxes.
SECOND AUDIO PROGRAMMING/SAP	Second Audio Programming (SAP) is another, separate, audio channel available with some programming. Choosing SAP often refers to listening to audio in another language, such as Spanish or French.
SIGNAL	Picture and sound traveling through cable, or on the air, to your television screen.
SOURCE	The term for the equipment that provides audio and video information to your TV. Antennas, VCRs, DVD players, and Cable Boxes are examples of sources.
STEREO SOUND	Stereo (stereophonic) sound refers to audio that's divided into right and left sides.
SURF	This function creates a customized list of your favorite channels. You can access this group of channels with the surf button on the remote by pressing Surf repeatedly.
S-VIDEO	(Y-C) connection available for S-Video devices providing better picture quality than standard video inputs.
TEXT	Arbitrary text not related to the program.
TUNER	Any device that picks up broadcast signals and turns them into picture and sound.
TWIN PICTURE	Feature that splits the screen and places two picture sources side-by-side.
XGA	A high-resolution computer data format compatible with these TVs.

Product Specifications

Models

RU-44SZ51D	Horizontal Size (Inches)	41.7
	Height (Inches)	30.1
	Depth (Inches)	14
	Weight (lbs.)	64
RU-52SZ51D	Horizontal Size (Inches)	48.6
	Height (Inches)	35.1
	Depth (Inches)	15.3
	Weight (lbs.)	80
Power Requirement	AC 120V, 60Hz	
Television System	American TV Standard, NTSC, ATSC with STB	
Television Channels	VHF: 2 - 13 UHF: 14 - 69 CATV: 1 - 125	
Power Consumption (W)	270W	
Antenna	75 ohm External Terminal for VHF/UHF	
Audio Output (W)	15W x 2	
Supplied Accessories	Remote control, 2 size AA batteries.	
External Input/Output Ports	Video input (3 set) Video output (1 set) S-Video input (2) Component input (2 set) RGB input (1) DVI input (1) RGB/DVI audio input (1 set) Variable audio output (1 set) Audio center mode input (1) Calibration port (1)	



Design and specifications are subject to change without prior notice.

CONCERNING PIXEL FUNCTIONALITY: Your DLP Rear Projection Television contains about 921600 individual pixels. DLP Projection displays typically contain a small number of pixels that do not function normally. Your display has been inspected and is in compliance with manufacturer's specifications, indicating that any pixel defects do not effect the operation or use of your display.

READ YOUR OPERATING GUIDE CAREFULLY SO THAT YOU UNDERSTAND THE OPERATION OF YOUR DLP REAR PROJECTION DISPLAY AND HOW TO ADJUST THE CONSUMER CONTROLS.

IMPORTANT: Please fill out and mail in your Product Registration Card or go to www.lgservice.com to register your product online. This information allows us to reach you promptly should we discover a safety or reliability problem that could affect you.

CUSTOMER ASSISTANCE NUMBERS

To obtain customer assistance, product information, or Dealer or Service locations	Call 1-800-243-0000 24 hours a day, 365 days per year
---	--

FOR SERVICE:

For warranty service information, please contact the LG®Brand Customer Support telephone number listed below.

When calling for service, please have your product model number, serial number and the date of purchase or the date of original installation available.

If a replacement unit is required, under some circumstances you may be asked to provide a reserve deposit to the LG®Brand Service Center against a credit card number as surety for advanced shipment. Your credit card will not be charged if you return the defective unit within 10 working days.

If a replacement unit is received, please use the carton and packaging from that unit in returning the defective unit to the LG®Brand Service Center.

Parts and service in accordance with the LG®Brand warranty is our responsibility and will be provided without charge. Other service requirements will be at the owner's expense. If you have problems in obtaining satisfactory warranty service, write or call the LG®Brand Customer Interactive Service.

To assure proper credit and avoid unnecessary charges, you must obtain a Return Authorization before returning any product to the Factory Service Center. Contact the number below or your authorized LG®Brand repair facility for details.

Before you call for warranty service, check your operating guide – you may avoid a service call.

LG®Brand Customer Interactive Center
P. O. Box 240007
201 James Record Road
Huntsville, Alabama 35824
ATTN: CIC

Telephone number: 1-800-243-0000
This number is a toll-free number
Follow menu prompts when the call is answered

Web address: www.lgservice.com

Telephone Center Hours of Operation:
24 hours a day, 365 days per year

Service for your LG®Brand Rear Projection Television is provided through LG Electronics Alabama, Inc., the authorized LG®Brand Service Center for the United States.

LG®Brand DLP Rear Projection Televisions are marketed and distributed in the United States by LG Electronics Corporation, 2000 Millbrook Drive, Lincolnshire, IL 60069.



LG® Brand
DLP Rear Projection Television
U.S. Limited Warranty

Your LG® brand DLP Rear Projection Television will be repaired or replaced as set forth below, if it proves to be defective in material or workmanship under normal use, during the warranty period ("Warranty Period") listed below, effective from the date ("Date of Purchase") of original consumer purchase of the product. This warranty is good only to the original purchaser of the product and effective only when used in the United States, excluding U.S. Territories.

<p>WARRANTY PERIOD:</p> <p>LABOR: One Year from the Date of Purchase. Your unit will be repaired or replaced with a new, substitute model or factory reconditioned unit, at the manufacturer's option. If repair, parts used in the repair may be new or remanufactured.</p> <p>Parts, except for Halogen Bulb: One Year from the Date of Purchase.</p> <p>Halogen Bulb: 90 Days from the Date of Purchase.</p> <p>Replacement Units and Repair Parts are warranted for the remaining portion of the original unit's warranty period.</p> <p>EFFECTIVE DATE OF WARRANTY: Your warranty period begins on the date of sale to the original consumer / end user. KEEP THE DEALER'S DATED BILL OF SALE OR PROOF OF DELIVERY as evidence of the purchase date. You will be required to submit a legible copy of your bill of sale or proof of delivery when requesting warranty service.</p>	<p>In-Home Service is available on this Unit, as provided in this Warranty. Please retain dealer's dated bill of sale or delivery ticket as evidence of the Date of Purchase for proof of warranty, and submit a copy of the bill of sale to the service person at the time warranty service is provided.</p> <p>Please call 1-800-243-0000</p> <p>To locate your nearest LG® Brand Authorized Service Center and to schedule a service appointment.</p> <p>For further Instructions, see "For Service" below</p>
--	---

THIS WARRANTY IS IN LIEU OF ANY OTHER WARRANTY, EXPRESS OR IMPLIED, INCLUDING WITHOUT LIMITATION, ANY WARRANTY OF MERCHANTABILITY OR FITNESS FOR A PARTICULAR PURPOSE. TO THE EXTENT ANY IMPLIED WARRANTY IS REQUIRED BY LAW, IT IS LIMITED IN DURATION TO THE EXPRESS WARRANTY PERIOD ABOVE. NEITHER THE MANUFACTURER NOR ITS U.S. DISTRIBUTOR SHALL BE LIABLE FOR ANY INCIDENTAL, CONSEQUENTIAL, INDIRECT, SPECIAL, OR PUNITIVE DAMAGES OF ANY NATURE, INCLUDING WITHOUT LIMITATION, LOST PROFITS, LOST OR CORRUPTED PROGRAMMING OR DATA, OR ANY OTHER DAMAGE WHETHER BASED IN CONTRACT, TORT, OR OTHERWISE. Some states do not allow the exclusion or limitation of incidental or consequential damages or limitations on how long an implied warranty lasts, so the above exclusion or limitation may not apply to you. This warranty gives you specific legal rights and you may also have other rights that vary from state to state.

THIS LIMITED WARRANTY DOES NOT APPLY TO:

<ul style="list-style-type: none"> ● damage caused in shipping or transit ● service required as a result of improper installation, including incorrect or insufficient AC supply (please consult the owner's manual for power supply requirements). ● installation or repair of antenna systems, cable converters, cable company supplied equipment, or other components in a video system ● set-up or adjustment on consumer controls, or damage caused by improper adjustments ● damage caused by other system components ● any unit that has been modified or incorporated into any other product ● replacement of batteries on the remote control. ● replacement of the Halogen Bulb except within the first 90 days 	<ul style="list-style-type: none"> ● damage (including cosmetic damage), failure, loss or personal injury due to misuse, abuse, negligence, improper maintenance or storage, or to acts of nature or other causes beyond our control. (Causes beyond our control include but are not limited to lightning strike, power surges, power outages and water damage.) ● repair or replacement of warranted parts by other than an LG® Brand authorized service centers. ● units purchased or serviced outside of the U.S.A. ● product where the original factory serial numbers have been removed, defaced or changed in any way. ● product sold and labeled as "as is, where is" or similar disclaimer.
--	--

The cost of repair or replacement under these excluded circumstances shall be borne by the consumer.

P/N : 3828VA0220X (b)(NB03JC)

Free Manuals Download Website

<http://myh66.com>

<http://usermanuals.us>

<http://www.somanuals.com>

<http://www.4manuals.cc>

<http://www.manual-lib.com>

<http://www.404manual.com>

<http://www.luxmanual.com>

<http://aubethermostatmanual.com>

Golf course search by state

<http://golfingnear.com>

Email search by domain

<http://emailbydomain.com>

Auto manuals search

<http://auto.somanuals.com>

TV manuals search

<http://tv.somanuals.com>