



LG

Life's Good

Owner's Manual

Laser Display install guide

Please read the safety information carefully before using the product.

Safety Precautions

Please take note of the safety instructions to prevent any potential accident or misuse of the product.

- Safety precautions are given in two forms, i.e. Warning and Caution as detailed below.

⚠ WARNING: Failure to follow the instructions may cause serious injury and even death.

⚠ CAUTION: Failure to follow the instructions may cause minor injury or damage to the product.

- Read the owner's manual carefully and keep it to hand.

Installation

⚠ WARNING

- The product should be installed by a qualified professional specified by the retail store.
 - The product installation by a non-qualified personnel is dangerous and may cause personal injury.
- The product should be installed where its weight can be supported.
 - Otherwise, the product may fall and cause personal injury.
- When moving or replacing the product after installation, contact a qualified installer specified by the retail store.
 - If an unqualified person moves and installs the product, this may cause safety issues as this task requires the special technique.
- Do not hang on the product or apply shock to the product.
 - The product may fall and cause injury.

⚠ CAUTION

- Follow the instructions in the manual to install the product.
 - Otherwise, it may cause serious injury or damage to the product.
- When installing the product or adjusting the height of the product, two or more people are needed.
 - If you do it by yourself, you may drop the product causing personal injury or damage to the product.
- When installing the product, check whether the wall is strong enough to hold the product and use the anchors and screws provided.
 - Otherwise, they may not bear the weight of the product causing safety issues.

- When drilling the holes in the wall, make sure you use a drill and a drill bit with the specified size of diameter. Ensure that you also follow the instructions regarding the depth of the holes.
 - Otherwise, the product may be installed improperly causing safety issues.
- Do not clean the product with wet towels, and do not use a heater or humidifier underneath the product.
 - Moisture permeating into the product, steam or heat may result in fire, electric shock or damage to the product.
- Keep the product away from sprinklers, sensors, high-tension wires and power sources. Do not install the product in a location where vibrations or shock impacts are likely to occur.
- Wear working gloves when installing the product. Do not use bare hands.
 - Otherwise, it may cause personal injury.

PREPARATION

Accessories

Check the accessories provided with the product.

The picture may be different from the actual product.

Accessories are subject to change without prior notice in order to improve the performance of the product. New accessories may be added or old ones may be removed.

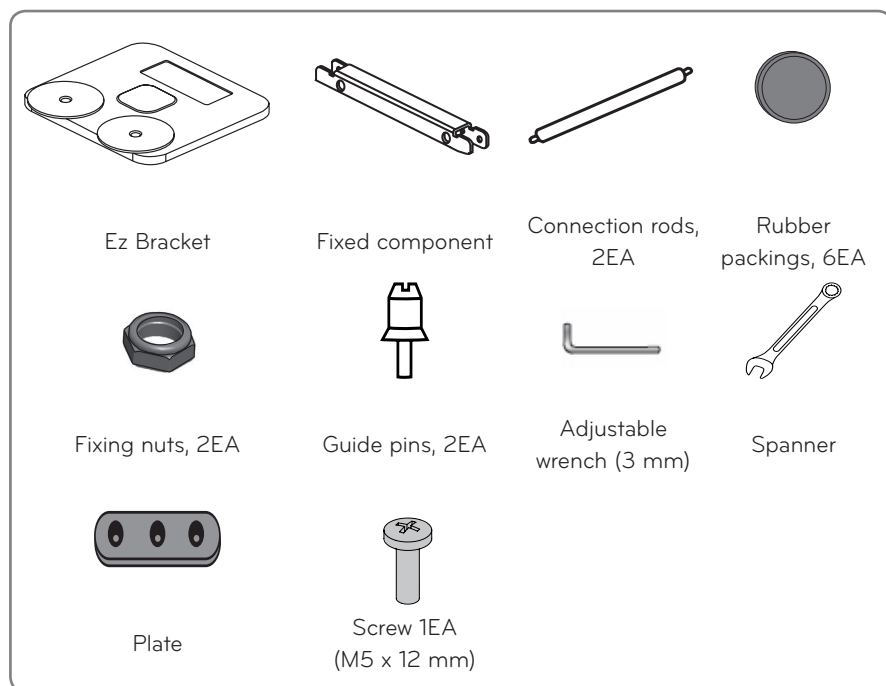

Preparations

Ø8 mm drill bit for concrete, leveler, tapeline, driver, tape

INSTALLATION

How to fix anchors and screws



CAUTION

- Check the wall materials and the thickness of finishing materials.
- You can use the anchors and bolts provided with the Laser Display set for walls made from concrete, lightweight concrete, soft fieldstone, hard fieldstone, brick or cellular blocks.
- When installing it on a wall not specified in this manual, make sure each fixing point withstands an uplifting load of 70 kgf (686 N) and a shearing load of 100 kgf (980 N) or more.
(Attach a plate such as plywood to strengthen the wall before installation.)

- At each anchor position, use a 8 mm drill bit to make a hole with a depth of 80 mm - 100 mm.
- Clean the holes.
- Insert the anchors provided into each hole.
(Use a hammer when inserting the anchor.)
- Fix a part in place by aligning it with the screw hole.
Tighten the screw with a torque 45 kgf/cm - 60 kgf/cm or higher.

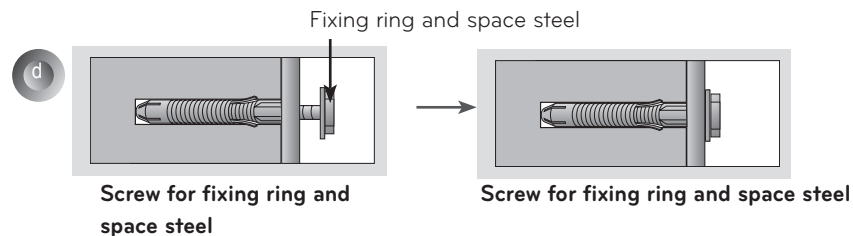
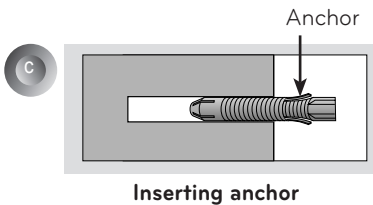
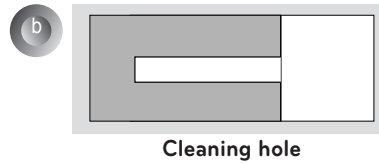
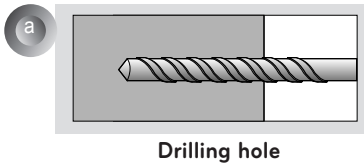

Installation Procedure (Stand Type)

- 1 Install the guide pins at the bottom of the set.

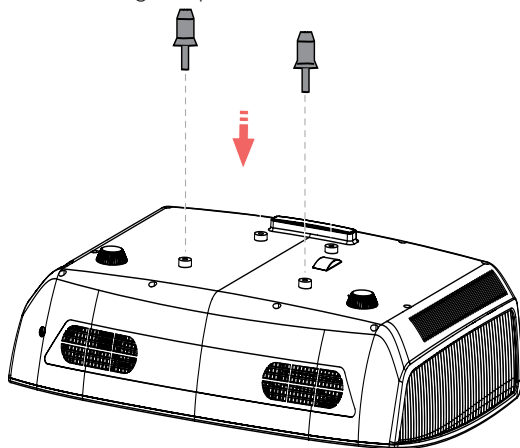

- 2 Connect the connection rod to the Ez bracket main unit and place it on a table, without the fixed components, at the center of the screen.

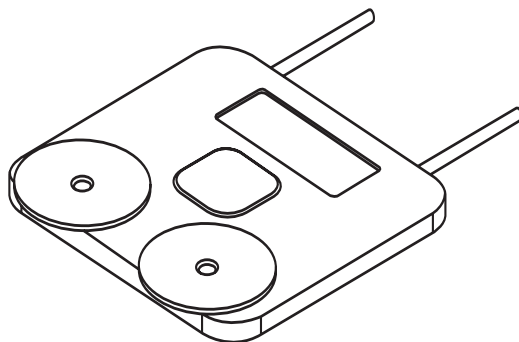

! **NOTE**

- Do not assemble the fixed components to the unit yet.

3 If the Ez bracket does not stay level, attach a rubber to the bottom of the bracket to make it level.

(If you cannot make it level using a rubber, remove or add a plate. To add a plate, make sure to use screws that came with the product.)

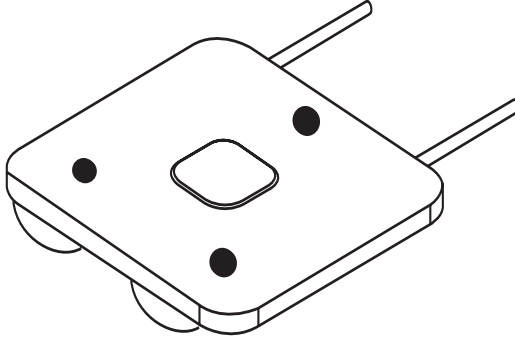
**NOTE**

- If you cannot make it level by attaching a rubber, remove or add a plate. (To add a plate, make sure to use screws that came with the product.)

4 Place the Laser Display onto the Ez bracket by aligning the guide pins and the holes on the adjustable bracket.

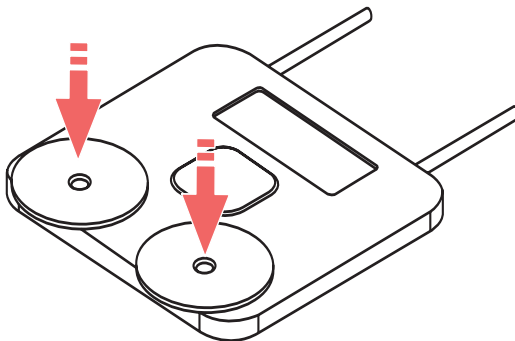

- 5 Attach 390 mm of guide tapes to the top of the table referring the sides of Laser Display so that the tapes are vertically upward.

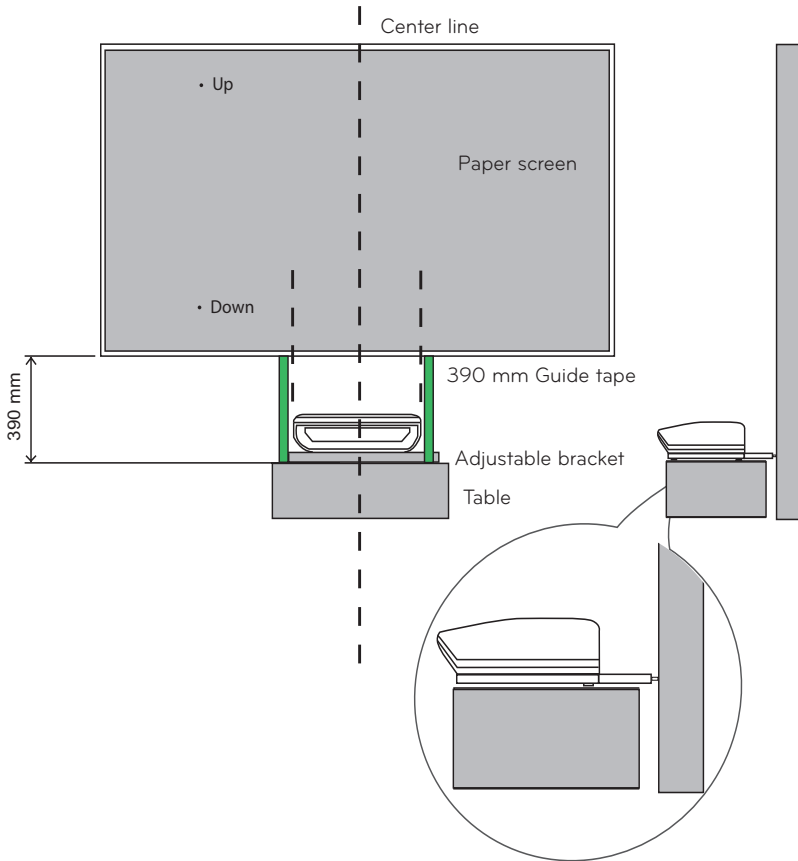

NOTE

- The figure above illustrates the fixed components which are not fixed yet.

- 6 Attach the paper screen above the tape. Refer to the guide tape to keep it level. (The paper screen helps to easily install the adjustable bracket and bore holes in the wall.)
- 7 Place the Ez bracket with the Laser Display installed close to the wall.
- 8 Turn on the power on the Laser Display.

- 9 Adjust the Ez bracket by following the Laser Display screen adjustment steps to make the size of the projection screen equal to that of the paper screen. Position the projection screen, aligning it with the black line of the paper screen. (If there is a gap larger than 10 mm between the projection screen and the paper screen, mark the screen position on the paper screen and make holes in four places.)

 **CAUTION**

- When adjusting the screen with the paper screen, do not move the Ez bracket to the left or right. If it is necessary to move the bracket, detach the paper screen first. If you make too many left/right adjustments, further adjustments may not be possible due to lack of marginal space when actually attaching and using the screen.

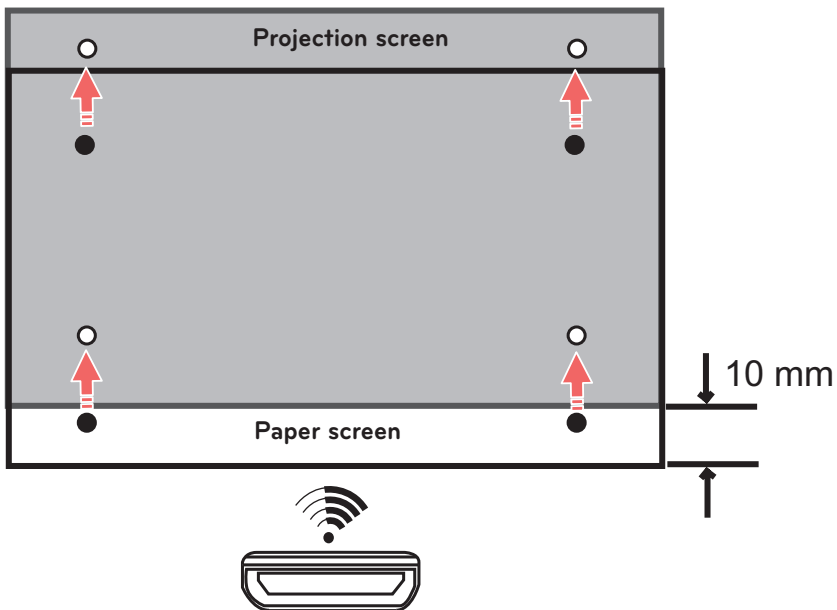

- 10** Place guide tape on both sides of the paper screen in parallel with it. Position the tape about 40 mm above the paper screen. The tape is used as a reference guide to help easy screen installation.

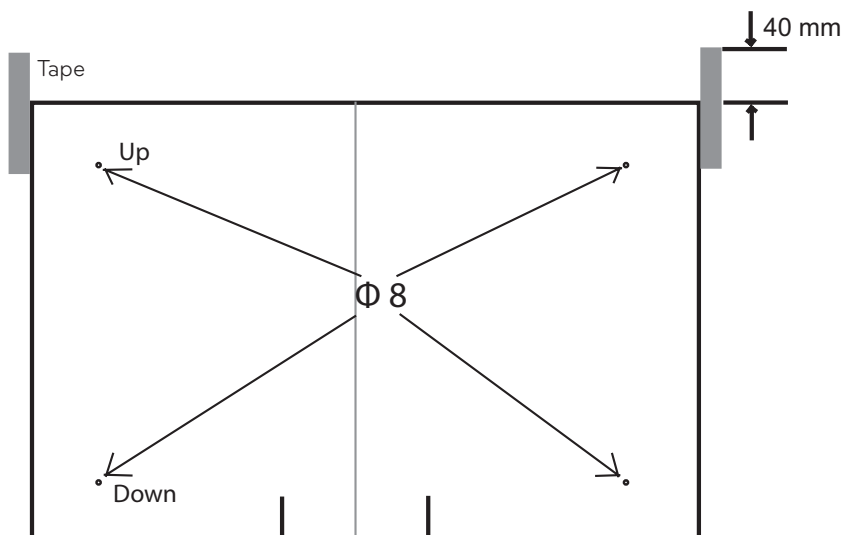

- 11** Make holes using an 8 mm drill at specified positions and detach the paper screen.
- 12** Insert the anchors into the four holes.
- 13** Fix rings into the two upper holes and space steels to the two lower holes using 8 mm bolts. Attach three magnets to the space steels fixed at the bottom.

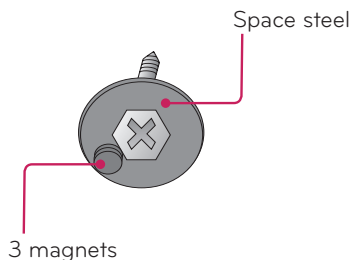

- 14** Mark the end of Ez bracket rod on the wall.
(Mark the positions of the holes where the Ez brackets will be fixed.)

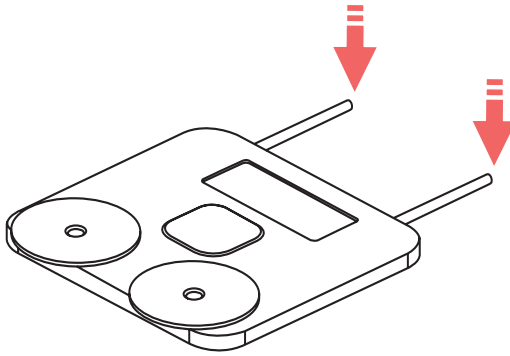

- 15** Remove the Laser Display set and Ez bracket from the table.

- 16** Position both holes of the fixed component against the marks on the wall and mark the positions where the anchors will be inserted.

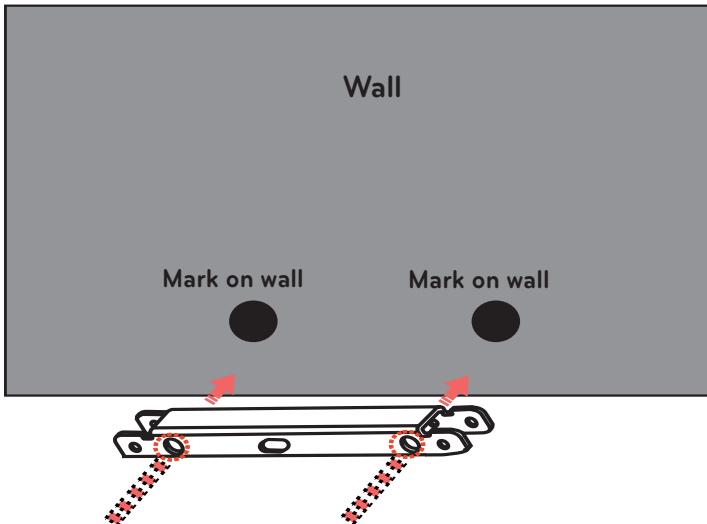

- 17** Make holes in the two locations marked with arrows using an 8 mm drill.

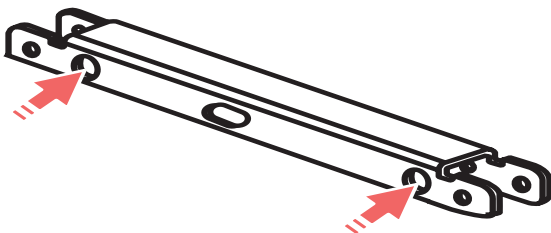

- 18** Detach the paper screen and insert the anchors into the two holes.

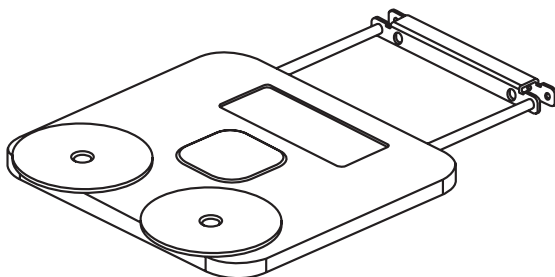

- 19** Secure the fixed component using two 8 mm screws.
(If adjustment is not possible due to lack of marginal space while aligning an image to the screen, loosen the screws and move the fixed component slightly to the left or right.)

- 20** Fix the Ez bracket to the fixed component using the spanner and fixing nuts provided with the product.

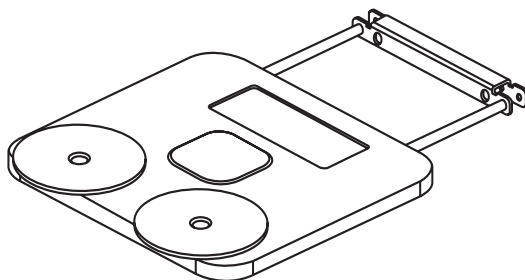

- 21** Place the Laser Display set onto the Ez bracket.

22 Two people must lift the screen above the guide tape and hang it on the rings. Keep the arrows pointing down.



CAUTION

- Align the top of screen with the top of the tape and the left and right sides of the screen with the tape. Hang the bracket on the rings by lowering the screen carefully. If the screen is upside down, the screen will be dark and no image will be displayed.

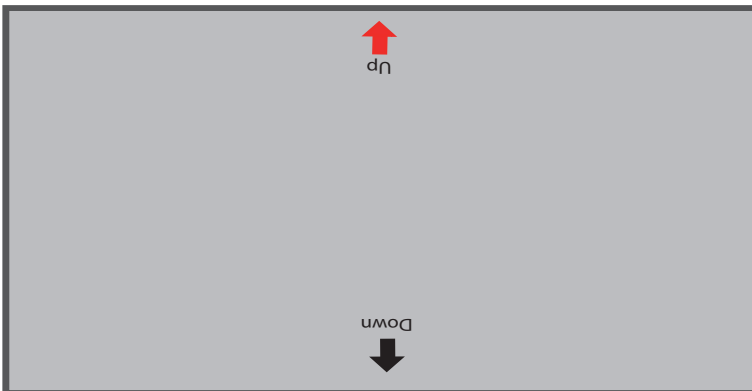
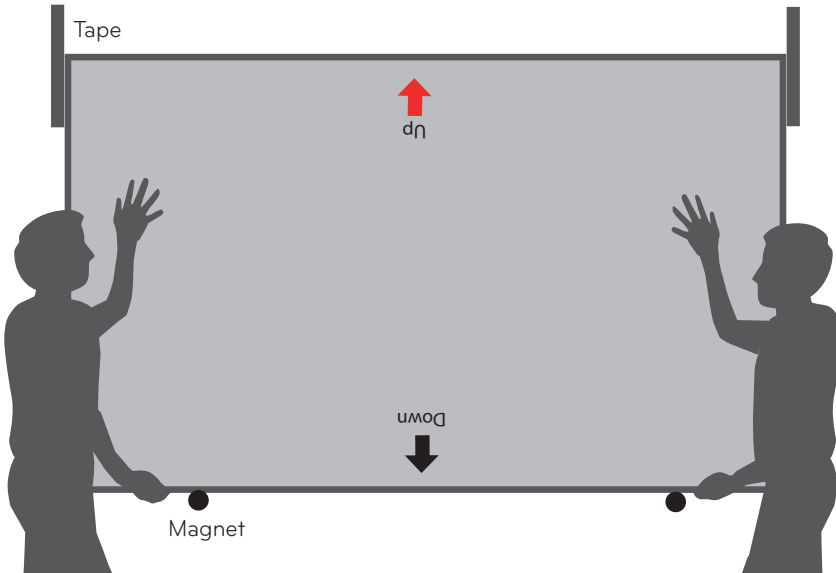

**CAUTION**

- If the screen is tilted when pulling it down, it may not fix to the bracket and could result in damage to the screen.

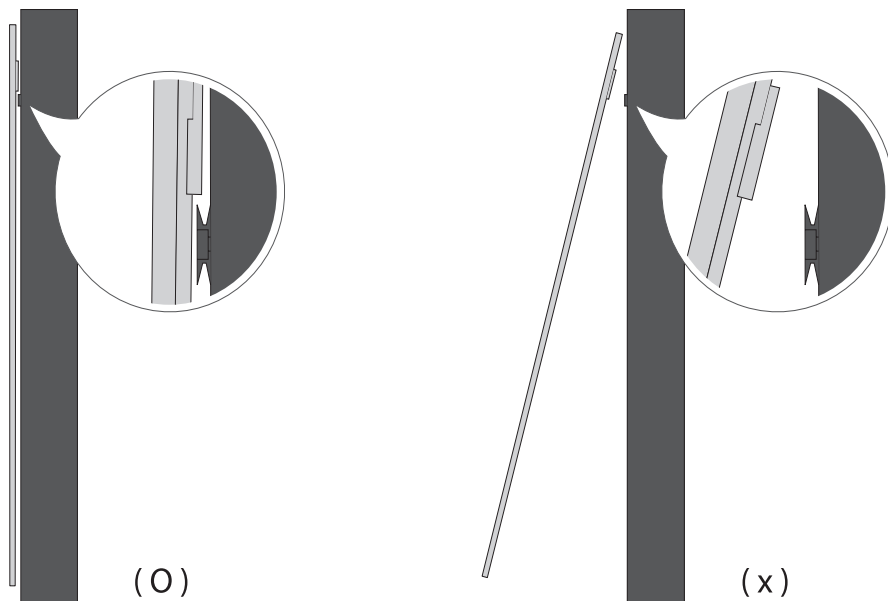

23 Move the screen in all directions to check that it is securely hung on the rings.

24 Check whether the screen stays level using a leveler.

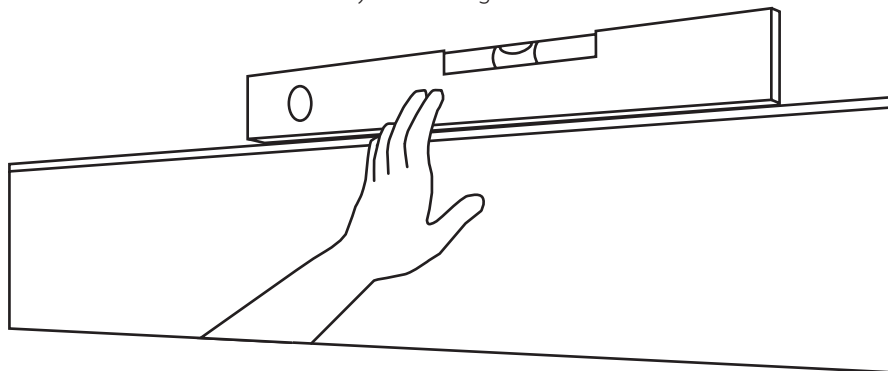

25 Check that the right and left sides of the screen are parallel to the wall using a leveler. If it is not parallel to the wall, calibrate the screen angle using the space steels.

Unhang the screen and remove the fixed rings and magnets.

Calculate the amount of space steels to be used using the formula below, locate the space steels between the wall and the rings/magnets and fix them again, and align the screen to be parallel to the wall.

($0.1^\circ \rightarrow 2 \text{ mm} \rightarrow 1 \text{ space steel}$)

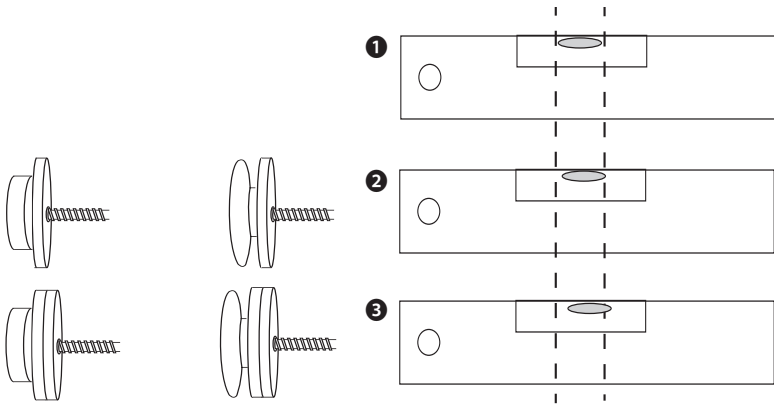
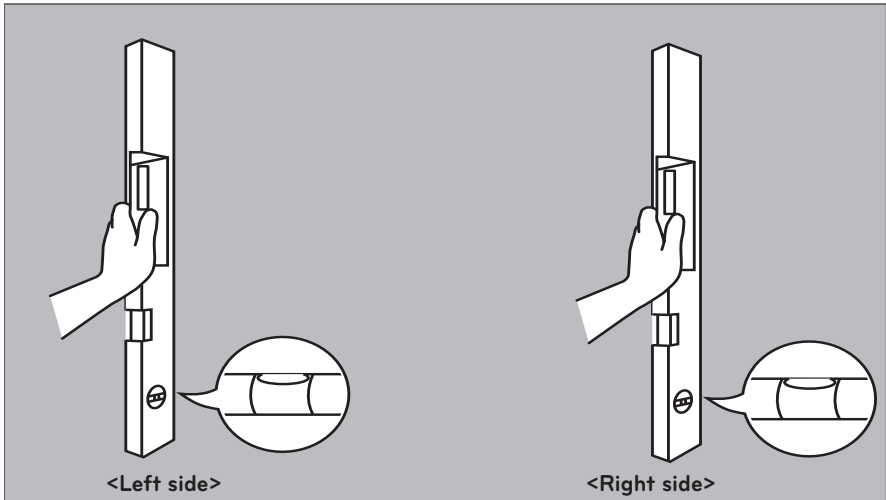

	Horizontal	Vertical
1	Horizontal	Vertical
2	$0.2^\circ \rightarrow$ Move to the next hole	$0.1^\circ \rightarrow$ Insert 2 space steels
3	$0.3^\circ - 0.4^\circ \rightarrow$ Skip 2-3 holes	$0.2^\circ \rightarrow$ Insert 3-4 space steels

If the screen is not parallel to the wall

NOTE

- If the top of the screen is tilted to the wall, add space steels at the top and, if the bottom of screen is tilted to the wall, add magnets at the bottom to make the screen parallel to the wall.

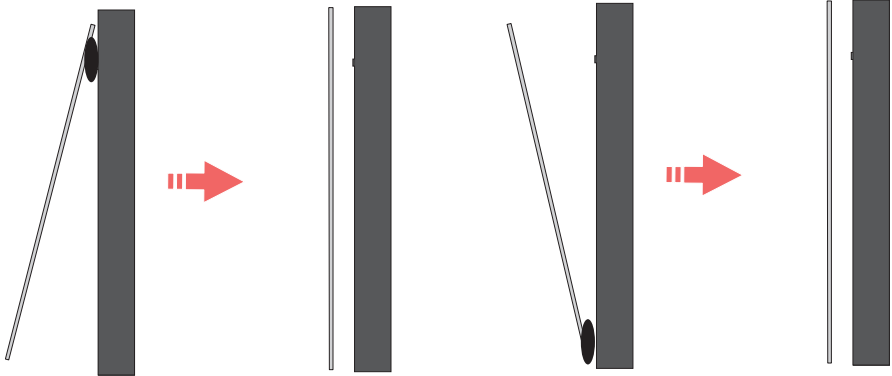

If the screen does not stay level

If you want to move the screen vertically or if it does not stay level, remove the screen and adjust the bracket on the back. Loosen the six screws of the bracket to move it and fasten the screws again.

(4 mm of distance between slots = 0.14°)
 (Hang the screen again following steps 9-12.)

NOTE

- When you fix a bracket screw to a lower hole, the screen goes up. When you fix a bracket screw to a higher hole, the screen goes down.
- The left and right bracket assemblies are different as shown below.

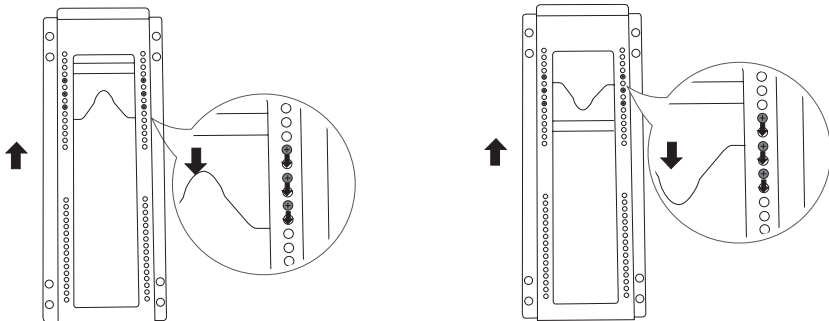

Left

Right

* If the screen is tilted to the right as shown below, fix the left bracket screw to a higher hole or fix the right bracket screw to a lower hole.

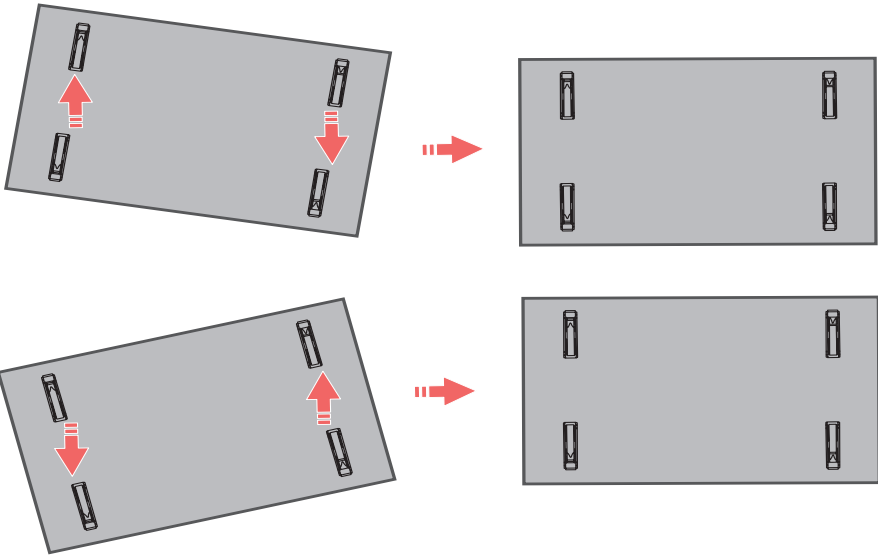

26 Refer to the screen adjustment steps to align the image from the Laser Display to the screen.

27 Complete fine tuning by pressing the **Edge Adj** button on the remote control. (Press the MENU button on the remote control and select Edge Adj in OPTION.)

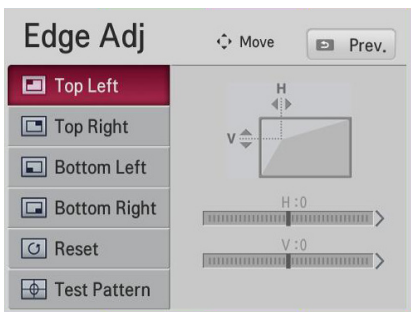

NOTE

- With the Edge Adj function, you cannot enlarge the screen size, but you can only reduce it.

Ez Bracket Adjustment Guide

1. Reset projection

- * Press the **Edge Adj** button on the remote control and select **Reset**.
(Select Settings → OPTION → Edge Adj → Reset to reset the position of the projection.)

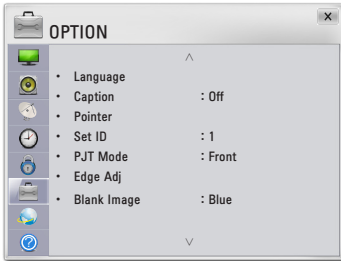

2. Adjust the projection to fit within the screen

1 If the projection is too large

Insert the hex wrench into the hole as illustrated (left) and turn it counterclockwise to reduce the size of the projection.

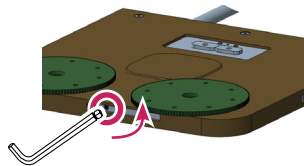
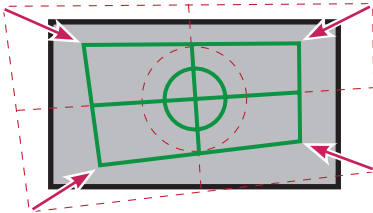

2 To move the projection to the left

Insert the hex wrench into the hole as illustrated (left) and turn it counterclockwise to move the projection to the left.

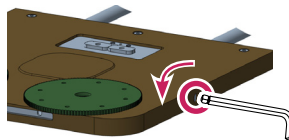
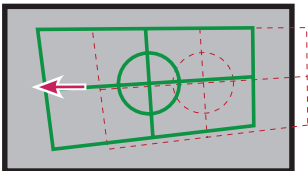

3 To move the projection to the right

Insert the hex wrench into the hole as illustrated (left) and turn it clockwise to move the projection to the right.

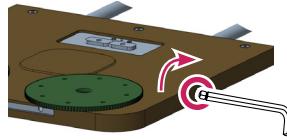
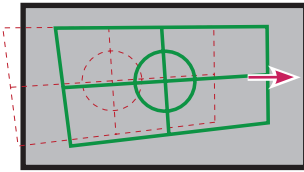

CAUTION

- If you are using a paper screen, align the paper screen with the projection and reattach it to the wall rather than moving the projection to the left or right.

3. Adjust the left and right widths of the projection so they are equal

1 To widen the left width of the projection and narrow the right width

Insert the hex wrench into the hole as illustrated (left) and turn it clockwise.

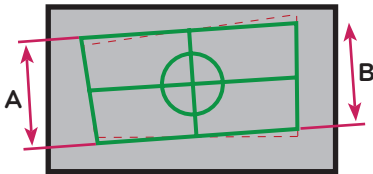

* Length A = Length B

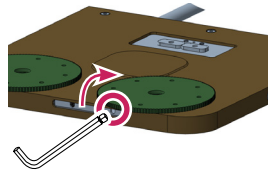

2 To widen the right width of the projection and narrow the left width

Insert the hex wrench into the hole as illustrated (left) and turn it counterclockwise.

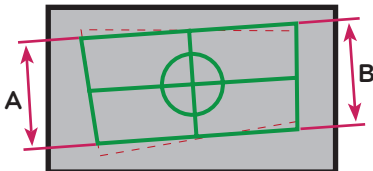

* Length A = Length B

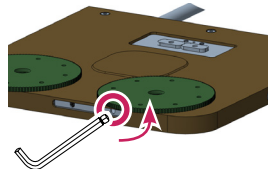

4. Adjust the horizontal line of the projection to be parallel with the width of the screen

1 To turn the projection clockwise

Turn the left control panel counterclockwise and turn the right control panel clockwise.

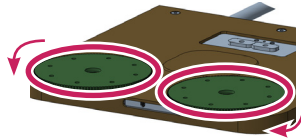
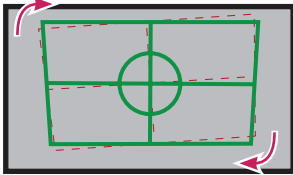

2 To widen the left width of the projection and narrow the right width

Turn the left control panel counterclockwise and turn the right control panel clockwise.

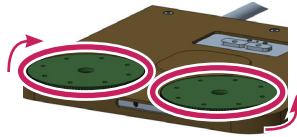
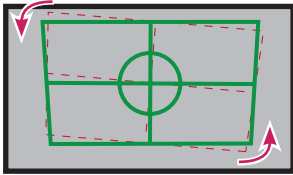

NOTE

- In this case, go back to Step 3 to adjust the widths so they are equal. In this case, go back to Step 3 to adjust the widths so they are equal. In this case, go back to Step 3 to adjust the widths so they are equal.

5. Adjust the top and bottom widths of the projection so they are equal

- 1** To narrow the top width of the projection and widen the bottom width
Turn the left and right control panels counterclockwise simultaneously.

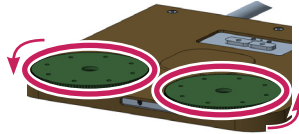
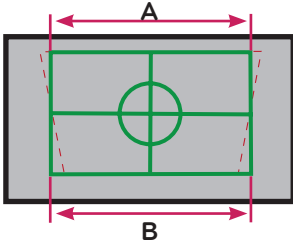

* Length A = Length B

- 2** To widen the top width of the projection and narrow the bottom width
Turn the left and right control panels clockwise simultaneously.

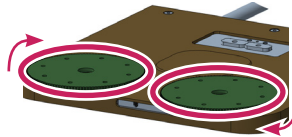
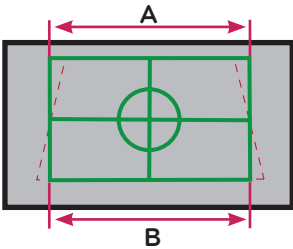

* Length A = Length B

6. If the projection is rectangle-shaped,

1 Enlarge the projection to fit the screen size

Insert the hex wrench into the hole as illustrated (left) and turn it clockwise to enlarge the size of the projection.

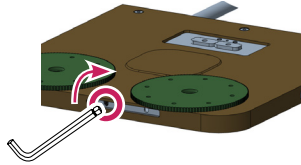
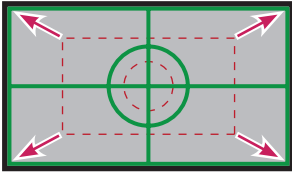

2 To move the projection to the left

Insert the hex wrench into the hole as illustrated (left) and turn it counterclockwise to move the projection to the left.

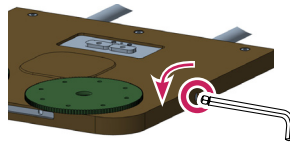
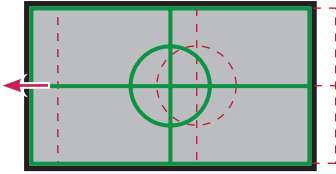

3 To move the projection to the right

Insert the hex wrench into the hole as illustrated (left) and turn it clockwise to move the projection to the right.

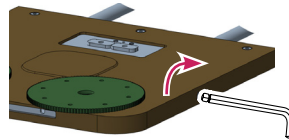
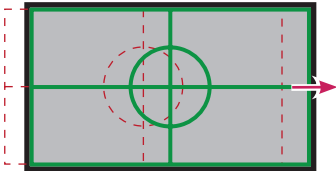

CAUTION

- If you are using a paper screen, align the paper screen with the projection and reattach it to the wall rather than moving the projection to the left or right.

7. When the projection is the same size as the screen, fine-tune the projection location using Edge Adj function

- * Complete fine tuning by pressing the Edge Adj button on the remote control.
(Press the MENU button on the remote control and select Edge Adj in OPTION.)





Free Manuals Download Website

<http://myh66.com>

<http://usermanuals.us>

<http://www.somanuals.com>

<http://www.4manuals.cc>

<http://www.manual-lib.com>

<http://www.404manual.com>

<http://www.luxmanual.com>

<http://aubethermostatmanual.com>

Golf course search by state

<http://golfingnear.com>

Email search by domain

<http://emailbydomain.com>

Auto manuals search

<http://auto.somanuals.com>

TV manuals search

<http://tv.somanuals.com>