



website:<http://us.lge.com>

☎ **1-800-243-0000**

24 HOURS A DAY, 7 DAYS A WEEK FOR LG CUSTOMER SERVICE
para el Servicio LG (Atención al Cliente) 24 horas al día, 7 días a la semana

LSC 21943ST

SXS REFRIGERATOR

User's Guide

Please read this guide thoroughly
before operating and keep it handy for
for reference at all times.

SXS REFRIGERATEUR

Manuel d'utilisation

Prière de lire attentivement le présent manuel
avant d'utiliser le réfrigérateur.

Conserver à portée de main pour pouvoir le
consulter à tout moment.

FRIGORÍFICO **SXS**

Guía de usuario

Lea detenidamente estas instrucciones
antes utilizar el frigorífico y guárdelas
como referencia para el futuro.

Table of Contents

Introduction	Entry	3
	Important safety instructions	3
	Identification of parts	4
Installation	Where to install	5
	Door removal	6
	Mount the freezer and refrigerator compartment doors	7
	Water supply installation	7
	Water connection instruction guide	8
	Height adjustment	11
Operation	Starting	12
	Adjusting the temperatures and functions	12
	Shelf	18
	Bottle holder (Applicable to some models only)	18
	Egg box	19
	Humidity control in the vegetable compartment	19
	Deodorizer (Applicable to some models only)	19
	Optichill™ Temperature Transition Corner	20
	Temperature Change at Optichill™	20
Optichill™	20	
Suggestion on food storage	Location of foods	21
	Storing foods	22
Care and maintenance	How to remove and replace parts	23
	General information	25
	Cleaning	25
	Troubleshooting	26

Entry

The model and serial numbers are found on the inner case or back of refrigerator compartment of this unit. These numbers are unique to this unit and not available to others. You should record requested information here and retain this guide as a permanent record of your purchase. Staple your receipt here.

Date of purchase _____
 Dealer _____
 Dealer address _____
 Dealer phone no. _____
 Model no. _____
 Serial no. _____

Important safety instructions

Before use, this refrigerator must be properly installed and located in accordance with the installation instructions in this manual.

Never unplug your refrigerator by pulling on the power cord. Always grip the plug firmly and pull it straight out from the outlet.

When moving your appliance away from the wall, be careful not to roll over the power cord or to damage it in any way. Do not crush or damage the water line.

After your refrigerator is in operation, do not touch the cold surfaces in the freezer compartment, particularly when your hands are damp or wet. Skin could adhere to these extremely cold surfaces.

Unplug the power cord from the power outlet for cleaning or other requirements. Never touch it with wet hands because you can get an electric shock or be injured.

Never damage, bend, kink, pull out, or twist the power cord because damage to the power cord can cause product failure, fire, or electric shock. If you have doubts the appliance is properly grounded, consult a qualified electrician.

Never place glass products in the freezer because they may be broken from expansion when their contents are frozen.

Never put your hands within the ice storage bin of the automatic icemaker. You can be injured by the operation of the automatic icemaker.

The appliance is not intended for use by young children without supervision.

Young children should be supervised to ensure that they do not play with the appliance.

Never allow anyone to climb, sit, stand, or hang on the door. These actions may damage the refrigerator and even tip it over, causing severe personal injury.

Before you move your refrigerator into its final location, it is important to make sure you have the proper electrical connection.

A 115 Volt, 60 Hz., AC only, 15 or 20 amp, fused and grounded single-outlet circuit is required. Use an outlet that cannot be turned off by a switch. Do not use an extension cord.

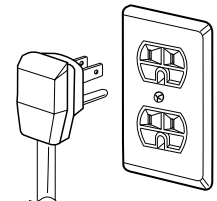

The refrigerator-freezer should be so positioned that the supply plug is accessible for quick disconnection in the event of an emergency.

If the supply cord is damaged, it must be replaced by the manufacturer or its service agent or a similarly qualified person in order to avoid any hazard.

Do not modify or extend the Power Cord length.

- It may cause electric shock or fire.



**Recommended
grounding
method**

**Accessibility of
supply plug**

**Supply cord
replacement**

⚠ Warning

Child entrapment warning

DANGER: Risk of child entrapment.

Before you throw away your old refrigerator or freezer:

Take off the doors but leave the shelves in place so that children may not easily climb inside.

The appliance is not intended for use by young children without supervision.

Young children should be supervised to ensure that they do not play with the appliance.

Don't store

Don't store or use gasoline or other flammable vapor and liquids in the vicinity of this or any other appliance.

Grounding (Earthing)

In the event of an electric short circuit, grounding (earthing) reduces the risk of electric shock by providing an escape wire for the electric current.

In order to prevent possible electric shock, this appliance must be grounded.

Improper use of the grounding plug can result in an electric shock. Consult a qualified electrician or service person if the grounding instructions are not completely understood or if you have doubts on whether the appliance is properly grounded.

Identification of parts

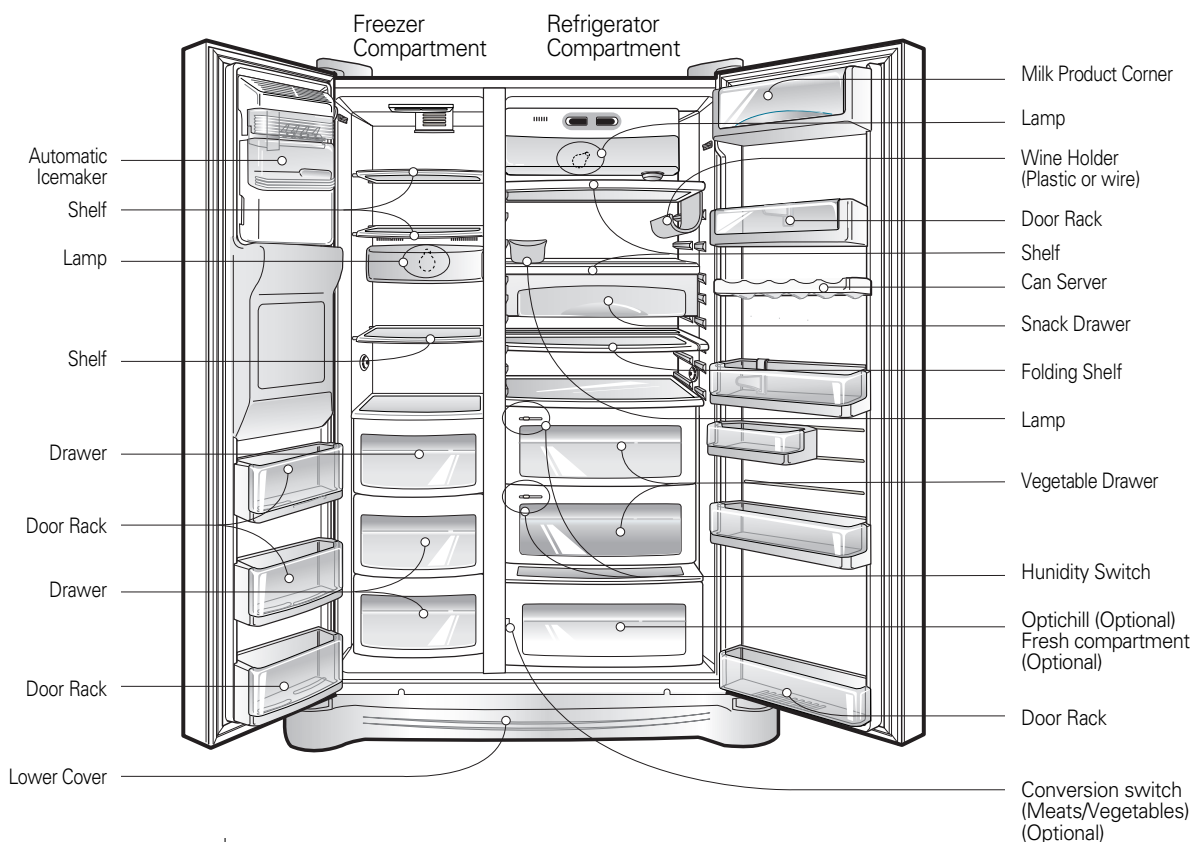

NOTE

- Parts, features, and options vary by model. Your model may not include every option.

Where to install

Strong and even floor

Unstable installation may cause vibration and noise. If the floor to install the refrigerator on is not even, make the refrigerator level by rotating the height adjusting screw. Carpet or floor covering on which a refrigerator is installed may be discolored by heat from the bottom of the refrigerator. Do not allow carpet or flooring to block airflow under the refrigerator.

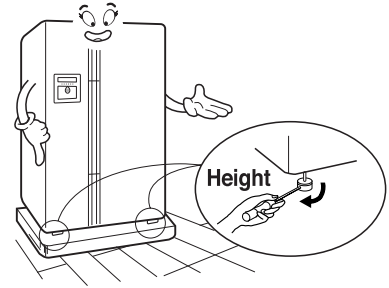

Select a good location

1. Place your appliance where it is easy to use.
2. Avoid placing the unit near heat sources, direct sunlight, or moisture.
3. To ensure proper air circulation around the refrigerator, please maintain sufficient space on both the sides as well as top and maintain at least 2 inches (5 cm) from the rear wall.
4. To avoid vibrations, the appliance must be leveled.
5. Don't install the appliance below 5°C (41°F). It may cause affect the performance.

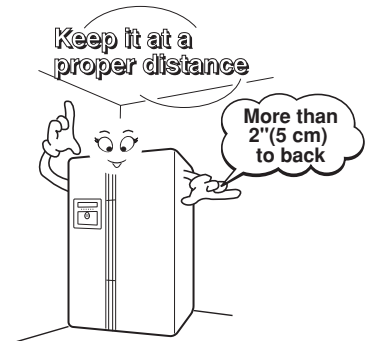

Where water supply can be easily connected in a dry place

Select a place where a water supply can be easily connected between the automatic ice maker and dispenser. Installing the refrigerator in a wet or damp area may cause rust and may be an electrical hazard.

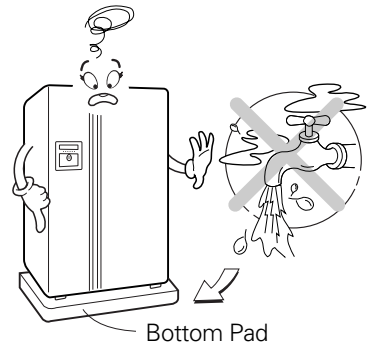

Where it is free from heat

If this refrigerator is installed where the ambient temperature is high, the freezing capacity is deteriorated and the cost of electricity used increases.

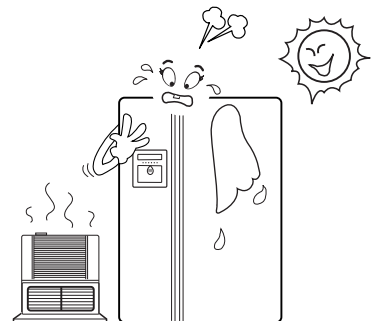

NOTE

- Install the refrigerator at a place where the ambient temperature is 5°C ~ 43°C (41°F~110°F). Ambient temperature outside this range may cause product malfunction. Also, the tube between the dispenser and automatic ice maker may freeze.

Door removal

Warning

Electric Shock Hazard

Disconnect electrical supply to refrigerator before installing.
Failure to do so could result in death or serious injury.

If your entrance door is too narrow for the refrigerator to pass through, remove the refrigerator door and pass the refrigerator laterally.

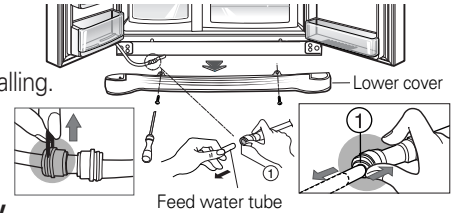

Remove lower cover and water feed tube

Remove the lower cover by lifting upward, and then pull up the water feed tube while pressing the release ring ① shown in the figure to the right.

NOTE

- If a tube end is deformed or abraded, trim the part away.
Disconnecting the tube under the door causes about 1/2 gallon (2 liters) water to flow out. Please put up a big container to prevent it.

Remove the freezer compartment door

1) Remove the hinge cover by loosening the screws. Disconnect all connections except the ground line.

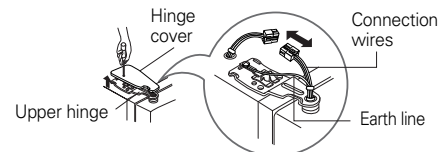

2) Remove the keeper by rotating it counter clockwise ① and then lifting the upper hinge up ②.

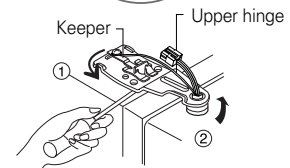

NOTE

- When removing the upper hinge, be careful that the door does not fall forward .

3) Remove the freezer compartment door by lifting it upward. This time, the door should be lifted enough for the water feed tube to be completely pulled out.

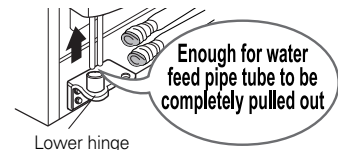

NOTE

- After removing the door, take it into the kitchen where you are installing the refrigerator. Lay it down on a blanket and be careful to avoid damaging the water feed tube.

Remove the refrigerator door

1) Loosen the hinge cover screws and remove the cover. Remove connection wire, if any, except for the ground line.

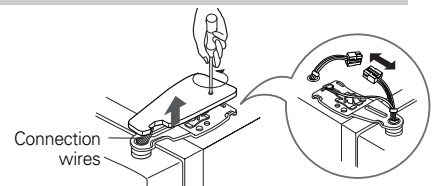

2) Remove keeper by rotating it clockwise ① and then remove the upper hinge by lifting it up ② .

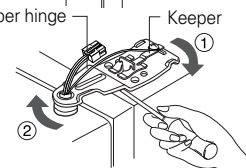

3) Remove the refrigerator compartment door by lifting it up.

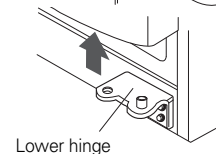

Pass the refrigerator

Pass the refrigerator laterally through the access door as shown in the right figure.

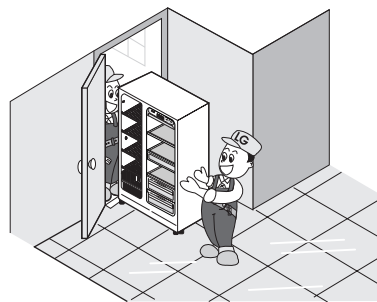

Mount the freezer and refrigerator compartment doors

Mount them in the reverse sequence of removal after they pass through the access door.

Water supply installation

Before installation

- Automatic icemaker operation needs water pressure of 21~121 psi (1.5~8.5 kgf/cm²) (That is, a paper cup (6 oz. or 180 cc) will be fully filled within 3 seconds.)
- If water pressure does not reach the rating 21 psi (1.5 kgf/cm²) or below, it is necessary to purchase a separate pressure pump for normal automatic icemaking and cool water feed.
- Keep the total length of the feed water pipe tube within 26' (8 m). Be careful for the tube to avoid being kinked. If the tube is 26' (8 m) or longer it may cause trouble in water feed.
- Install the water supply line where it will not be affected by heat.

Warning

- Connect to a potable water supply only.

Disposal of the old appliance

This appliance contains fluids (refrigerant and lubricant) and is made of parts and materials which are reusable and/or recyclable. All the important materials should be sent to the collection center of waste material and can be reused after rework (recycling). For recycling, please contact the local recycling authority.

Connecting the refrigerator to a water source

Warning

Water connection instruction guide

Read all directions carefully before you begin.

Connect to a potable water supply only.

IMPORTANT

- If operating the refrigerator before installing the water connection, turn icemaker to the **OFF** position to prevent operation without water.
- All installations must be in accordance with local plumbing code requirements.
- Use copper tubing and check for leaks.
- Install copper tubing only in areas where temperatures will remain above freezing.
- It may take up to 24 hours for your icemaker to begin producing ice.

Tools required

- Standard screwdriver
- 7/16-inch and 1/2-inch open-end wrenches or two adjustable wrenches
- 1/4-inch nut driver
- 1/4-inch drill bit
- Hand drill or electric drill (properly grounded)

NOTE

- Your refrigerator dealer has a kit available with a 1/4-inch saddle-type shut-off valve, a union, and copper tubing. Before purchasing, make sure a saddle-type valve complies with your local plumbing codes. Do not use a piercing-type or 3/16-inch saddle valve which reduces water flow and clogs more easily.

Cold water supply

The icemaker water valve contains a flow washer which is used as a water pressure regulator.

The icemaker needs to be connected to a cold water line with water pressure 20 ~ 120 psi (lb/inch²)

Connect the tubing to water line

1. Unplug refrigerator or disconnect power.
2. Turn OFF main water supply. Turn on the nearest faucet to relieve the pressure on the line. It may help to open an outside faucet to allow the water to drain from the line in the house.
3. Find a 1/2-inch vertical COLD water pipe near the refrigerator.

NOTE

- Horizontal pipe will work, but the following precaution must be taken: Drill on the top of the pipe, not the bottom. This will help keep water away from the drill. This also keeps normal sediment from collecting in the valve.

4. To determine the length of copper tubing you will need, measure from the connection on the lower left rear of the refrigerator to the water pipe. Add 7 feet (2.1m) to allow for moving refrigerator for cleaning. Use 1/4-inch O.D. (outside diameter) copper tubing. Be sure both ends of copper tubing are cut square.
5. Using a drill, drill a 1/4-inch hole in the cold water pipe you have selected.
6. Fasten shut-off valve to cold water pipe with pipe clamp. Be sure the outlet end is solidly in the 1/4" drilled hole in the water pipe and the washer is under the pipe clamp. Tighten the packing nut. Tighten the pipe clamp screws carefully and evenly so the washer makes a watertight seal. Do not overtighten or you may crush the copper tubing, especially if soft (coiled) copper tubing is used. Now you are ready to connect the copper tubing.
7. Slip the compression sleeve and the compression nut onto the copper tubing as shown. Insert the end of the tubing into the outlet end squarely as far as it will go. Screw compression nut onto the outlet end with a wrench. A flare nut wrench works best, but an open end wrench will suffice. Do not overtighten.
8. Place the free end of the tubing into a container or sink, and turn on the main water supply. Flush out the tubing until the water is clear. Turn off the shutoff valve on the water pipe. Coil the copper tubing as shown below.

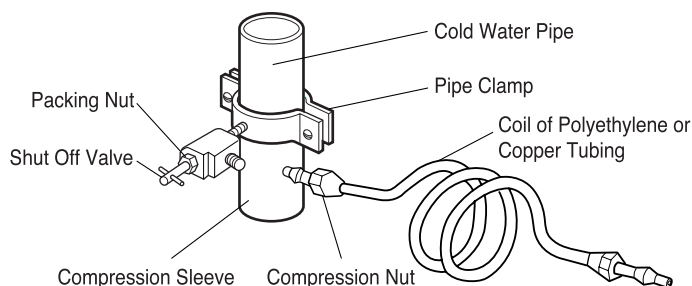

Connect the tubing to the refrigerator

Before making the connection to the refrigerator, be sure the refrigerator power cord is not plugged into the wall outlet.

- If your refrigerator does not have a water filter, we recommend installing one. If your water supply has sand or particles, that could clog the screen of the refrigerator's water valve. Install the filter in the water line near the refrigerator.

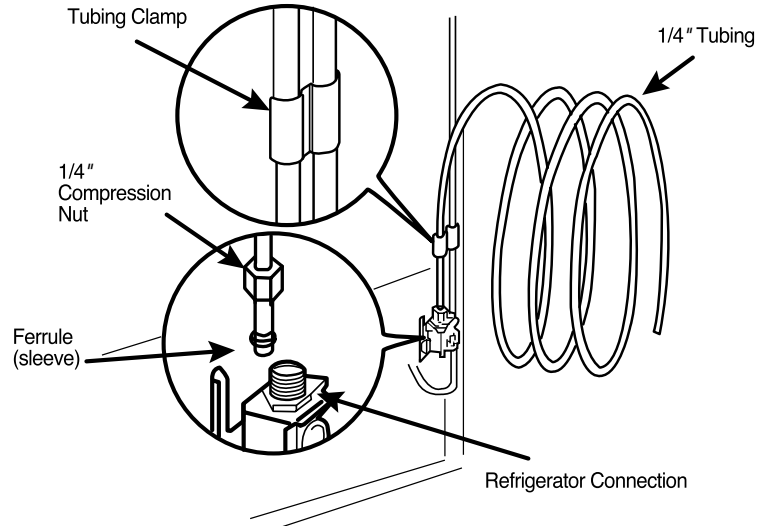

1. Remove the plastic flexible cap from the water valve.
2. Place the compression nut and ferrule (sleeve) onto the end of the tubing as shown.
3. Insert the end of the copper tubing into the connection as far as possible. While holding the tubing, tighten the fitting.

Turn the water on at the shutoff valve

Tighten any connections that leak.

■ Plug In the Refrigerator

Arrange the coil of copper tubing behind the refrigerator so it does not vibrate against the back of the refrigerator or against the wall. Push the refrigerator back to the wall.

■ Start the Icemaker

Set the icemaker switch to the ON position. The icemaker will not begin to operate until it reaches its operating temperature of 15 °F (-9 °C). It will then begin operation automatically.

Height adjustment

If the freezer compartment door is lower than the refrigerator compartment door

Make them level by inserting a flat (- type) driver into the groove of the left height adjusting screw and rotating it clockwise ①.

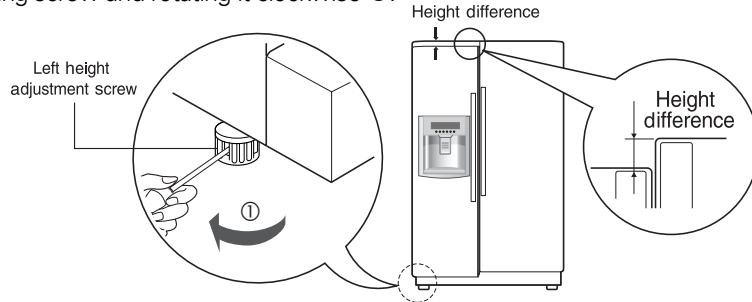

If the freezer compartment door is higher than the refrigerator compartment door - first method

Make them level by inserting a flat (- type) driver into the groove of the right height adjusting screw and rotating it clockwise ①.

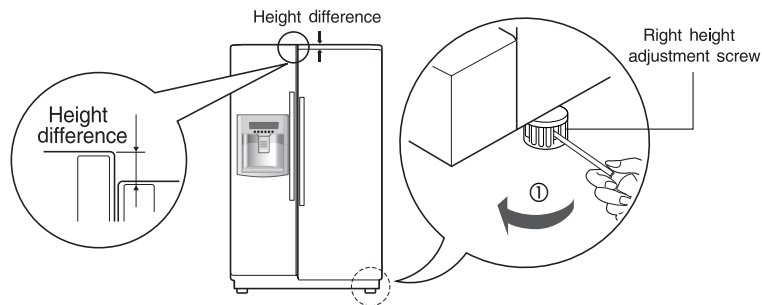

If the freezer compartment door is higher than the refrigerator compartment door - second method

Adjust the level when the refrigerator door is lower than the freezer door during the use of the refrigerator.

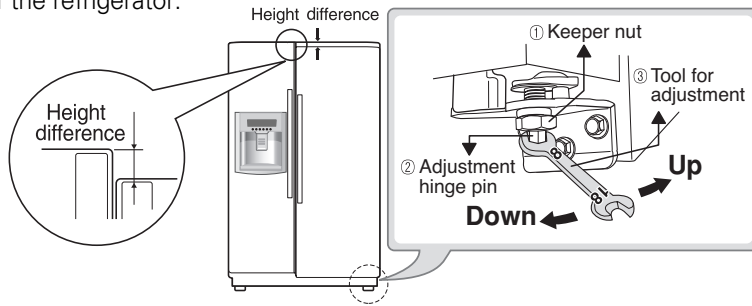

(Applicable to some models only)

1. Using the wide side of the tool for adjustment ③, turn the keeper nut ② (↻) clockwise to loosen the Keeper nut.
2. Using the narrow side of the tool for adjustment, turn the adjustment hinge pin ② (↻) clockwise or (↺) counterclockwise to level the refrigerator and freezer door.
3. After setting the level of the door, turn the keeper nut (↺) counterclockwise to tighten.

⚠ CAUTION

Do not force too hard to level the height. The hinge pin can be pulled out. (Adjustable range of height is a maximum of 2" (5 cm))

After leveling the door height

The refrigerator door will close smoothly by raising the front side by adjusting the height adjusting screw. If the door does not close properly because it is improperly adjusted, the performance of the refrigerator will be affected.

Starting

When your refrigerator is first installed, allow it to stabilize at normal operating temperatures 2~3 hours prior to filling it with fresh or frozen foods.
If operation is interrupted, wait 5 minutes before restarting.

Adjusting the temperatures and functions

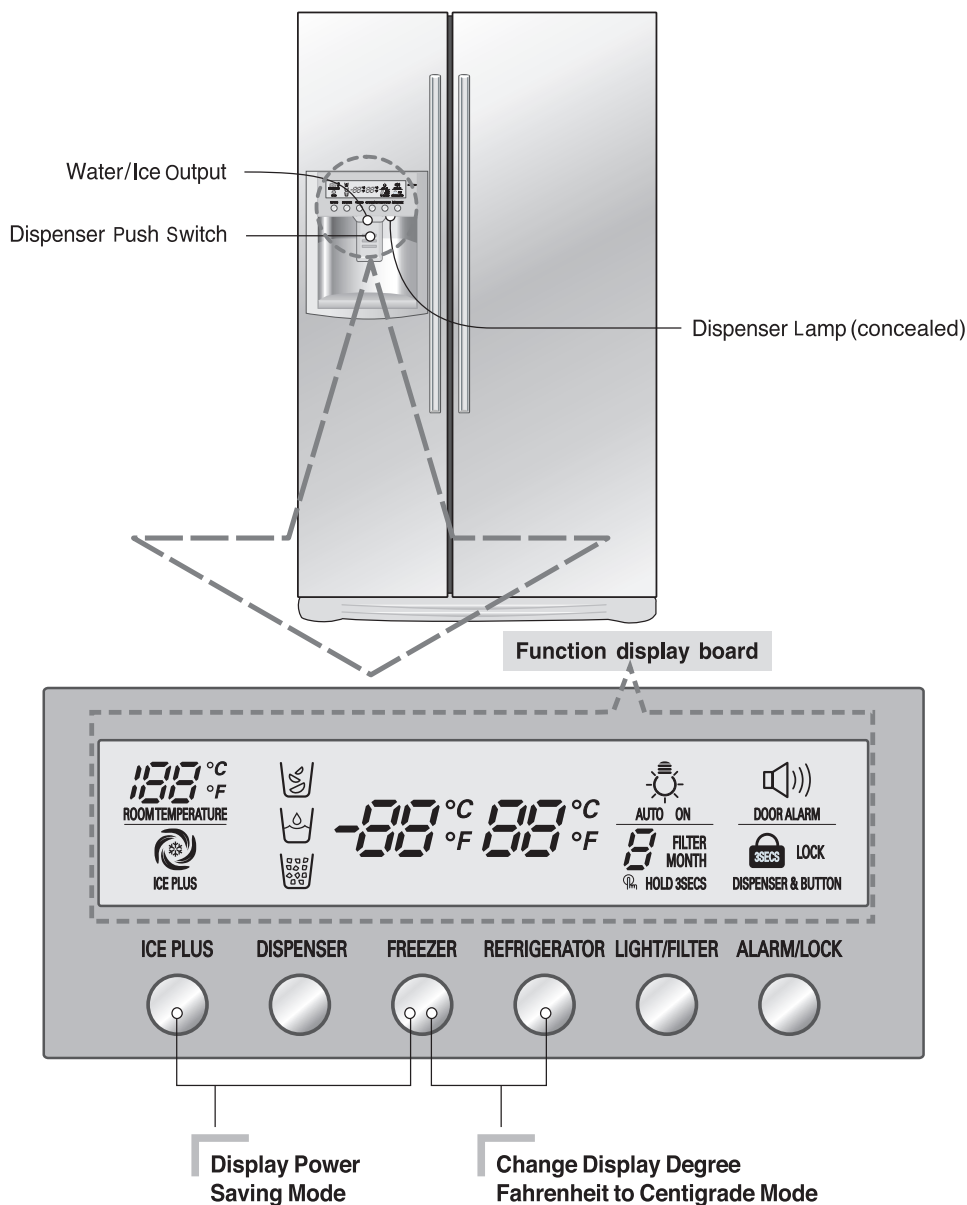

NOTE

- Your model may not include every option.
- The control display is operated by touch. Excessive moisture on the display may cause a malfunction. Please keep display clean and dry.

1. Display Power Saving Mode

This function places the display into power saving mode until the next time the door is opened.

Press the FREEZER and ICE PLUS buttons simultaneously and hold them for 5 seconds until the Ding sounds. All LEDs will then turn ON, then OFF. When the power saving mode is activated, the display will remain off until the next time the door is opened. Then, it will come on whenever a door is opened or a button is pressed and remain on for 20 seconds after the last door opening or button selection. To deactivate the power saving mode, press the FREEZER and ICE PLUS buttons simultaneously and hold them for 5 seconds until the Ding sounds.

2. To change temperature display from Fahrenheit to Celsius press and hold FREEZER and REFRIGERATOR buttons simultaneously for more than 5 seconds. Do the same to convert back to Celsius.

You can adjust temperature of freezer compartment and refrigerator Compartment.

How to adjust the temperature in the freezer compartment

Freezer Compartment temperature adjustment

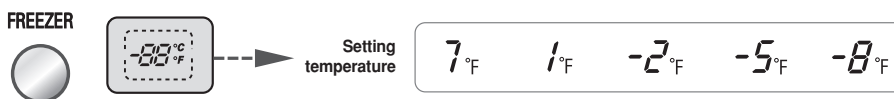

How to adjust the temperature in the refrigerator compartment

Refrigerator Compartment temperature adjustment



- * To adjust the temperature in the refrigerator compartment, press the REFRIGERATOR button to cycle through the settings of MEDIUM → COLDER → COLDEST → COOL → COOLER.
 - The actual inner temperature varies depending on the food status, as the indicated setting temperature is the target temperature, not actual the temperature within refrigerator.
 - Please adjust temperature as above after using the refrigerator for a minimum of 2~3 days.

How to use dispenser

- Select among crushed ice, water, and cubed ice and press the push switch with a glass or other container.

Crushed Ice

Light the crushed ice lamp by pressing the selection button.

- Crushed ice will be dispensed by pressing the push switch with a glass.

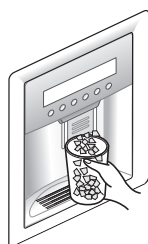
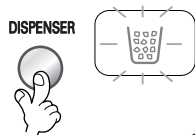

Water

Light the water lamp by pressing the selection button.

- Water will be dispensed by pressing the push switch with a glass.

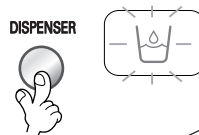

Cubed Ice

Light the cubed ice lamp by pressing the selection button.

- Cubed ice will be dispensed by pressing the push switch with a glass.

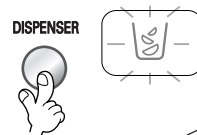

- **Reference :** Hold your cup in place for a couple of seconds after dispensing ice or water so the last few drops go in to your cup instead of on the floor.

Automatic icemaker

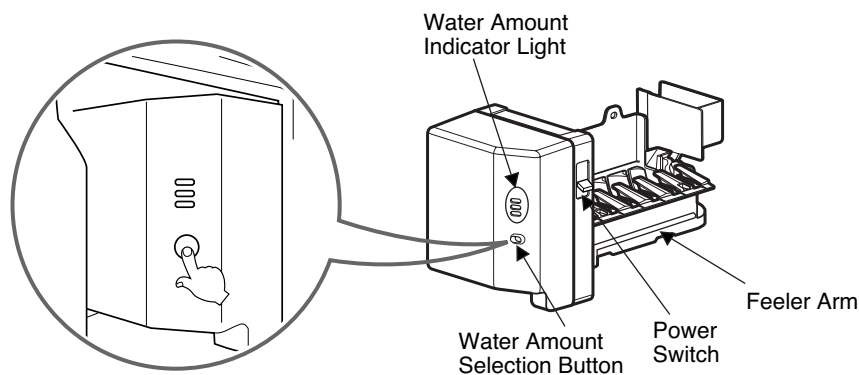

- The automatic icemaker can automatically make 6 cubes at a time, 70~120 pieces per day. This quantity may vary by circumstance, including ambient temperature, door opening, freezer load. etc.
- Icemaking stops when the ice storage bin is full.
- If you don't want to use the automatic icemaker, turn the icemaker switch to OFF. If you want to use the automatic icemaker again, change the switch to ON.
- The water amount will vary depending on the water amount selection button setting as well as the water pressure of the connected water line.

NOTE

- It is normal that a noise is produced when ice drops into the ice storage bin.

When ice dispensing does not operate smoothly

Ice is lumped together

- If the ice lumps together, take it out, break it apart, and put it back into the storage bin.
- When the icemaker produces too small or lumped together ice, the amount of water supplied to the ice maker needs to be adjusted. Contact the service center.
- ✳ If ice is not used frequently, it may lump together.

Power failure

- Water may drop from the refrigerator. Take the ice storage bin out and discard all the ice, then dry it and place it back. After the power is restored, the refrigerator defaults to crushed ice.

The unit is newly installed

- It takes about 12 hours for a newly installed refrigerator to make ice.

 **CAUTION**

Throw away the first few batches of ice. The first ice and water may include particles or odor from the water supply line or the water tank.

This is also necessary if the refrigerator has not been used for a long time.

Never store beverage cans or other foods in ice storage bin for the purpose of rapid cooling. It may damage the automatic ice maker.

Shake the bin occasionally to cause the ice to settle.

Ice may pile up just around the icemaker causing the icemaker to think that the ice storage bin is full.

If discolored ice is dispensed, contact an Authorized Service Center immediately. Do not use the ice or water until the problem is corrected.

 **Warning**

Do not place your hands into the water and ice dispenser opening. Doing so can result in amputation or cuts.



Ice plus/Jet freezer

Please select this function for prompt freezer.

- OFF → ICE PLUS → OFF or OFF → ON → OFF is repeated whenever pressing  button.
- The arrow mark graphic remains at the ON status after flickering 4 times when selecting Special Refrigeration On.
- The special freezer function automatically turns off after a fixed time passes.

ICE PLUS

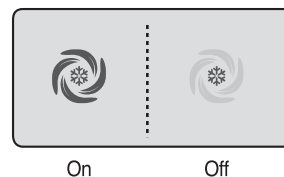

Lock

This button stops operation of different button and dispenser function.

- Locking or Release is repeated whenever the  is pressed more than 3 seconds.
- If you use the ALARM/LOCK button, none of the other buttons will work until you unlock them.

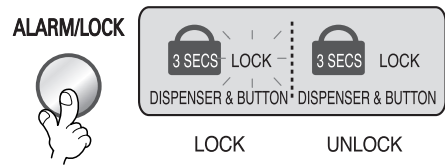

Door alarm

Door open warning

- A warning tone will sound 3 times at thirty-second intervals if the refrigerator or freezer door is left open for more than sixty seconds.
- Please contact the local service center if warning continue to sound even after closing the door.

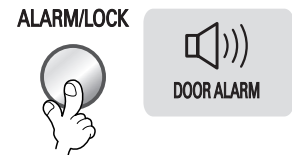

Filter condition (filter replacement cycle) display function

- There is a replacement indicator light for the water filter cartridge on the dispenser.
- The water filter should be replaced every six months.
- The filter light comes on to let you know when to replace filter.
- After replacing the filter, press and hold the filter button more than 3 seconds to reset the indicator.

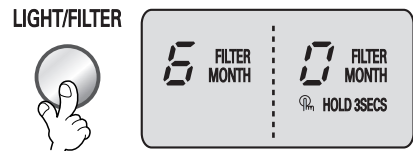

Dispenser light

This button turn the dispenser light in the dispenser on an off.

- The dispenser light function is turned ON or OFF by pressing Light/Filter button.
- If the dispenser light stays on for more than 7 minutes, it will turn off automatically.
- Some models have an auto mode that uses a light sensor to turn the dispenser light on and off.

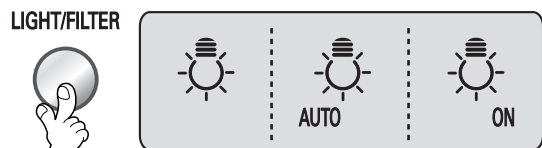

*Auto light is not applicable to all models.

Other functions

Ambient Temperature Display Window.

- Temperature is displayed only between 16°F ~ 120°F (-9°C ~ 49°C).
- Temperature below 15°F (-9°C) is indicated by LO and temperature above 121°F (49°C) is indicated by HI.



Diagnostic (failure detection) function

- The diagnostic function automatically detects failure when failure is found in product during the use of refrigerator.
- If your refrigerator fails, do not turn off the power. Call 1-800-243-0000 24/7 and select the option to locate an Authorized Servicer or call our support line for assistance. Turning off the appliance will make it more difficult for the service technician to determine the problem.

How ice/cold water is supplied

Water is cooled while stored in the water tank in freezer door, and then sent to the dispenser.

Ice is made in the automatic icemaker and sent to the dispenser.

Cautions

Throw away the ice (about 20 pieces) and water (about 7 glasses) first made after refrigerator installation.

This is also necessary when the refrigerator has not been used for a long time.

Keep children away from the dispenser.

Children may play with or damage the controls.

Be careful that food does not block the ice passage.

If foods are placed at the entrance of ice passage, the dispenser may malfunction. The passage may also become blocked with frost if only crushed ice is used. Remove the frost that accumulates.

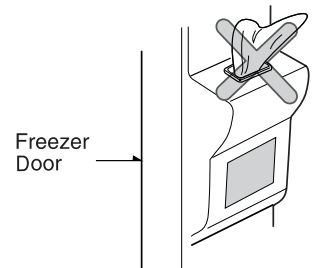

Storing cans or other items in the ice bin may damage the icemaker or the container may burst.

Never use thin crystal glass or crockery to collect ice.

Such glasses or containers may be broken, and glass fragments could be in the ice.

Put ice first into a glass before filling water or other beverages.

Water may be splashed if ice is added to existing liquid in a glass.

Keep your hands out of the ice door and passage.

You might break something or injure yourself.

Never remove the ice maker cover.

Shake the ice bin occasionally to level the ice in it.

Sometimes the ice piles up near the icemaker, causing the icemaker to misinterpret the bin level and stop producing ice.

If you find ice or water dispensed unexpectedly, contact an Authorized Service Center. (Call 1-800-243-0000 24/7 and select the option to locate an authorized servicer.)

Never use too narrow or deep glass.

Ice may be jammed in the ice passage and, thus, the refrigerator may fail.

Keep the glass at a proper distance from ice outlet.

A glass too close to the outlet may prevent ice from coming out.

Shelf

Folding Shelf

You can store taller items such as a gallon container or bottles by simply pushing in front half of shelf underneath back half of shelf. Pull toward you to return to a full shelf.

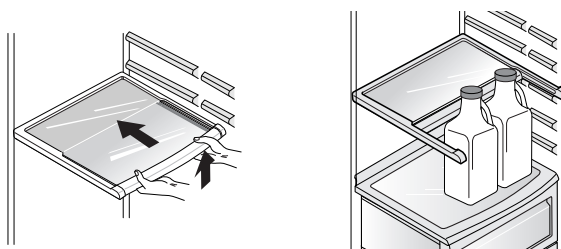

Bottle holder (Applicable to some models only)

Wine holder adjustment (Type 1)

Bottles can be stored laterally with this holder. This can be attached to any shelf.

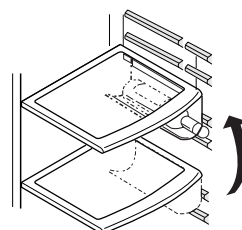

In case of inserting the bottle holder :

Pull the bottle holder downward as in ② after inserting it into the side anchoring part of the shelf as in ① by catching it upward as in ①.

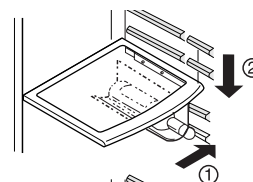

In case of separating the bottle holder :

Pull the bottle holder inward as in ④ after holding it upward as in ③ by catching it.

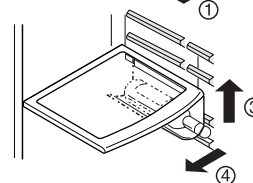

(Type 2)

Bottles can be stored laterally with this rack.

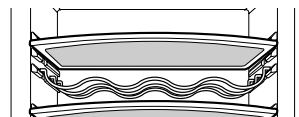

Egg box

You can move the egg box to wherever you want.

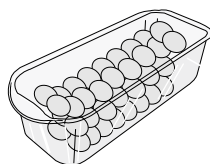

[Type-1]

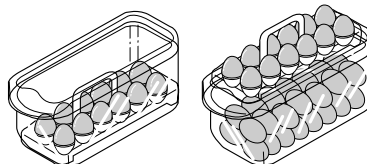

[Type-2]

NOTE

- Never use the egg box as an ice storage bin. It can be broken.
- Never store the egg box in the freezer compartment or fresh compartment.

Humidity control in the vegetable compartment

The humidity can be controlled by adjusting the humidity control switch to the left/right when storing vegetables or fruits.

High humidity

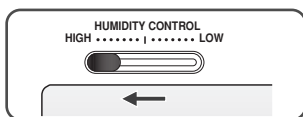

Low humidity

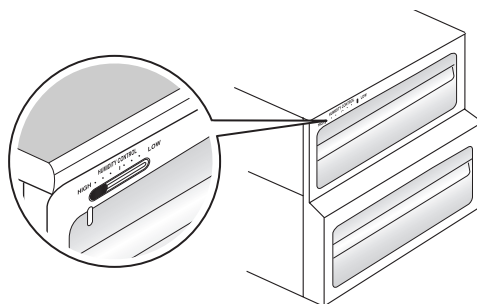
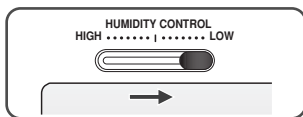

Deodorizer (Applicable to some models only)

This system efficiently absorbs strong odors by using the optical catalyst. This system does not have any effect on stored food.

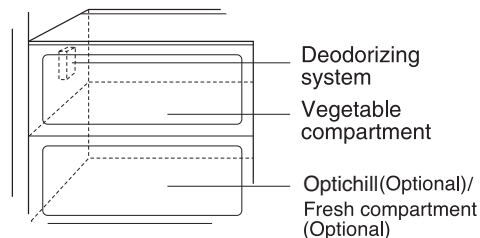

How to use the deodorizing system

- Since it is already installed onto the cool air intake duct from the refrigerator compartment, you need no separate installation.
- Use closed containers to store food with pungent odors. Otherwise, this odor will be absorbed by other food in the compartment.

Optichill™ Temperature Transition Corner

By pressing the button, store vegetables, fruits or other types of food such as meat to be defrosted, raw fish, etc.



Temperature Change at Optichill™

Method to Use

You can select optimum temperature range depending on types of foods stored.

- 3 steps of temperature selection are available, including 27°F, 30°F, 39°F. Vegetables, fruits, cold storage items requiring humidity maintenance, meats, and fishes can be stored under optimal conditions by selecting the correct storage temperature for the foods being stored.

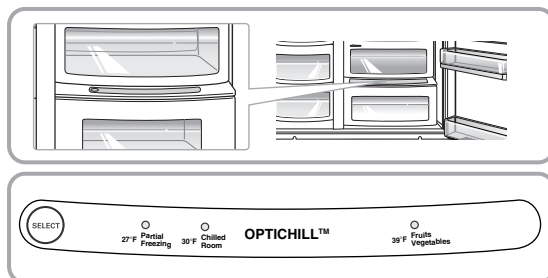

- When using the Optichill™ as storage room of meats, if stored there vegetables or fruits may be frozen
- When using the Optichill™ as storage room of meats, keeping meats or fishes may be spoiled and thus meats or fishes must be kept in the freezer.
- If you open the refrigerator door, an indicator lamp shows the status of the Optichill™. The lamp goes off when the door is closed.
- Press the left SELECT button to cycle through **FRUITS VEGETABLES(39°F)** → **CHILLED ROOM(30°F)** → **PARTIAL FREEZING(27°F)** → **FRUITS VEGETABLES(39°F)**.

Optichill™

When removing Optichill™

- First, remove the vegetable bin.
- After lifting the Optichill™ case slightly ①, reach inside and pull it outward ② .

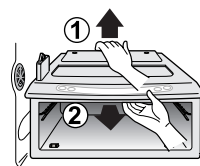

When installing Optichill™

- Fit the Optichill™ case on to the ledge ① and gently slide it in ② .
- When forced, the connecting parts can be damaged.

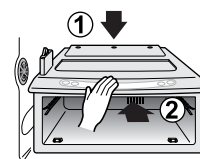

Location of foods

(Refer to identification of parts)

- Bottle holder** Store bottles.
- Snack drawer** Store small foods such as bread, snacks, etc..
- Freezer compartment shelf** Store various frozen foods such as meat, fish, ice cream, frozen snacks, etc..
- Freezer compartment door rack**
- Store small packed frozen food.
 - Temperature is likely to increase as door opens. So, do not store long-term food such ice cream, etc..
- Freezer compartment drawer**
- Store meat, fish, chicken, etc. after wrapping them with thin foil.
 - Store dry.
- Milk product corner** Store milk products such as butter, cheese, etc.
- Egg box** Place this egg box in the proper location.
- Refreshment center** Store foods of frequent use such as beverage, etc.
- Refrigerator compartment shelf** Store side dishes or other foods at a proper distance.
- Refrigerator compartment door rack** Store small packed food or beverages such as milk, juice, beer, etc.
- Vegetable drawer** Store vegetables or fruits.
- Vegetable drawer /meat drawer conversion corner** Store vegetable, fruits, meat to thaw, raw fish, etc. setting the conversion switch as necessary. Be sure to check the conversion switch setting before storing foods.

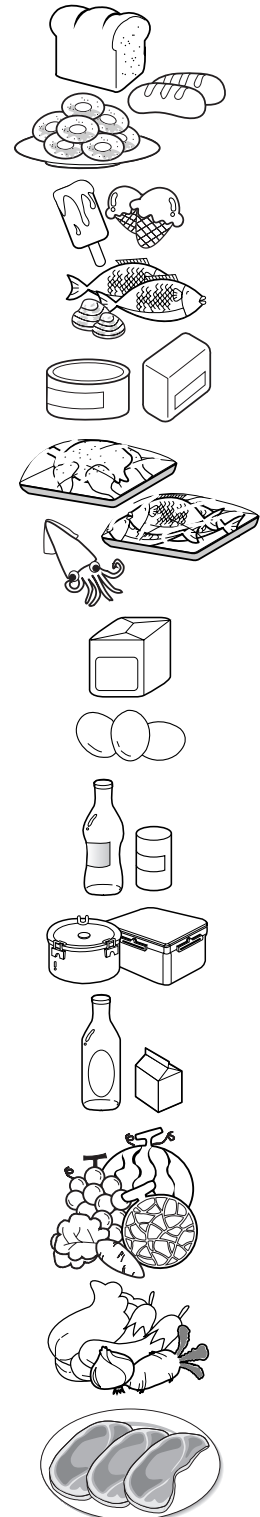

Storing foods

- Store fresh food in the refrigerator compartment. How food is frozen and thawed is an important factor in maintaining its freshness and flavor.
- Do not store food which spoils easily at low temperatures, such as bananas and melons.
- Allow hot food to cool prior to storing. Place hot food in the refrigerator could spoil other food and lead to higher energy consumption.
- When storing the food, cover it with vinyl wrap or store in a container with a lid. This prevents moisture from evaporating, and helps food to keep its taste and nutrients.
- Do not block air vents with food. Smooth circulation of chilled air keeps refrigerator temperatures even.
- Do not open the door frequently. Opening the door lets warm air enter the refrigerator, and cause temperatures to rise.
- Never keep too much food in door rack because they may push against by inner racks so that the door cannot be fully closed.

Freezer compartment

- Do not store bottles in the freezer compartment. They may break when frozen.
 - Do not refreeze food that has been thawed. This causes loss of taste and nutrient.
 - When storing frozen food like ice cream for a long period, place it on the freezer shelf, not in the door rack.
 - Do not touch the cold foods or containers- especially made of metallic -, with wet hands and place glass products in the freezer compartment.
- Damp skin may freeze upon contact with frozen surfaces, causing frostbite or other injury.

Refrigerator compartment

- Avoid placing moist food in top refrigerator shelves, it could freeze from direct contact with chilled air.
- Always clean food prior to refrigeration. Vegetables and fruits should be washed and wiped, and packed food should be wiped, to prevent adjacent food from spoiling.
- When storing eggs in their storage rack or box, ensure that they are fresh, and always store them in an upright position, which keeps them fresh longer.

NOTE

- If you keep the refrigerator in a hot and humid place, frequent opening of the door or storing a lot of vegetables in it may cause dew to form which has no effect on its performance. Remove the dew with dust cloth free from care.

How to remove and replace parts

NOTE

- Dismantling is done in the reverse sequence of assembly.
Be sure to unplug the power plug before dismantling and assembly.
Never apply severe force to dismantle parts. Parts may be damaged.

Freezer compartment lamp

Separate the lamp by pulling it out ③ while slightly striking ① and rotating ② the lamp cover. Turn the bulb counterclockwise. Max. 40 W bulb for refrigerator is used and can be purchased at a service center.

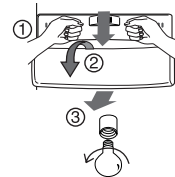

Freezer compartment shelf

To remove a shelf, push the shelf to the left ①, lift the left part of the shelf a bit ②, lift the right part up ③, and take it out.

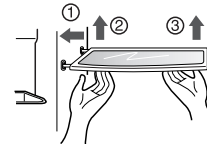

Door rack and support

Lift the door rack holding both sides ① and pull it out ②.

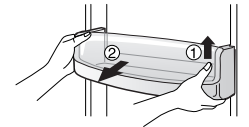

Ice storage bin

Hold the ice storage bin as shown in the right figure and pull it out ② while slightly lifting it ①.

- Do not dismantle the ice storage bin unless it is necessary.
- Use both hands to remove the ice bin to avoid dropping it.

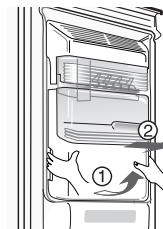

After dispenser is used

The water collector has no self-drainage function, so it should be cleaned regularly. Remove the cover by pulling the front of the water collector cover and dry it with a cloth.

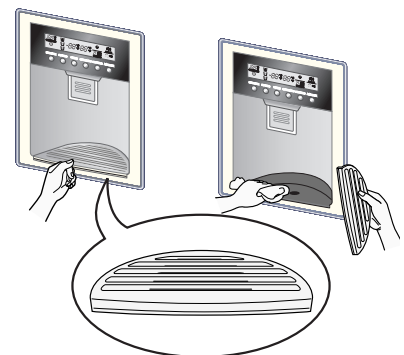

**Lamp in
refrigerator
compartment**

Insert the tool into the marked area (①) and push the tool to disconnect.

Use the tool with the flat tip such as a flat (-) screw driver.

Turn the bulb counterclockwise. Max. 40 W bulb for refrigerator is used and can be purchased at a service center.

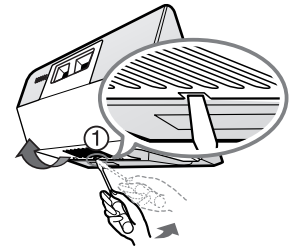
**Vegetable
compartment
cover**

- To remove the vegetable compartment cover, pull out the vegetable compartment a bit to the front ①, lift the front part of the vegetable compartment cover as shown by ②, and take it out.

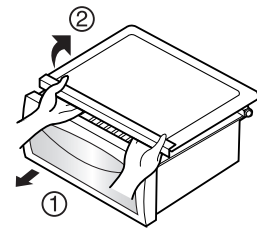

General information

Vacation time During average length vacations, you will probably find it best to leave the refrigerator in operation. Place freezable items in freezer for longer life. When you plan to turn it off, remove all food, disconnect the power cord, clean the interior thoroughly, and leave each door OPEN to prevent odor formation.

Power failure Most power failures that are corrected in an hour or two will not affect your refrigerator temperatures. However, you should minimize the number of door openings while the power is off.

If you move Remove or securely fasten down all loose items inside the refrigerator. To avoid damaging the height adjusting screws, turn them all the way into the base.

Anti condensation pipe The outside wall of the refrigerator cabinet may sometimes get warm, especially just after installation. Don't be alarmed. This is due to the anti-condensation pipe, which pumps hot refrigerant to prevent sweating on the outer cabinet wall.

Cleaning

It is important that your refrigerator be kept clean to prevent undesirable odors. Spilled food should be wiped up immediately, since it may acidify and stain plastic surfaces if allowed to settle.

Exterior Use a lukewarm solution of mild soap or detergent to clean the durable finish of your refrigerator. Wipe with a clean damp cloth and then dry.

Interior Regular cleaning is recommended. Wash all compartments a baking soda solution or a mild detergent and warm water. Rinse and dry.

After cleaning Please verify that the power cord is not damaged, power plug is not overheated, or power plug is well inserted into the power consent.

Warning Always remove power cord from the wall outlet prior to cleaning in the vicinity of electrical parts (lamps, switches, controls, etc.). Wipe up excess moisture with a sponge or cloth to prevent water or liquid from getting into any electrical part and causing an electric shock. Never use metallic scouring pads, brushes, coarse abrasive cleaners, strong alkaline solutions, flammable or toxic cleaning liquids on any surface. Do not touch frozen surfaces with wet or damp hands, because damp object will stick or adhere to extremely cold surfaces.

Troubleshooting

Before calling for service, review this list. It may save you both time and expense. This list includes common occurrences that are not the result of defective workmanship or materials in this appliance.

Occurrence	Possible cause	Solution
Runing of refrigerator		
Refrigerator compressor does not run.	Refrigerator control is off.	Set refrigerator control. See setting the controls.
	Refrigerator is in defrost cycle.	This is normal for a fully automatic defrosting refrigerator. The defrost cycle occurs periodically.
	Plug at wall outlet is disconnected.	Make sure plug is tightly pushed into outlet.
	Power outage. Check house lights.	Call local electric company.
Refrigerator runs too much or too long	Refrigerator is larger than the previous one you owned.	This is normal. Larger, more efficient units run longer in these conditions.
	Room or outside weather is hot.	It is normal for the refrigerator to work longer under these conditions.
	Refrigerator has recently been disconnected for a period of time.	It takes some hours for the refrigerator to cool down completely.
	Large amounts of warm or hot food may have been stored recently.	Warm food will cause the refrigerator to run longer until the desired temperature is reached.
	Doors are opened too frequently or too long.	Warm air entering the refrigerator causes it to run longer. Open the door less often.
	Refrigerator or freezer door may be slightly open.	Make sure the refrigerator is level. Keep food and containers from blocking door. See problem section. OPENING/CLOSING of doors.
	Refrigerator control is set too cold.	Set the refrigerator control to a warmer setting until the refrigerator temperature is satisfactory.
	Refrigerator or freezer gasket is dirty, worn, cracked, or poorly fitted.	Clean or change gasket. Leaks in the door seal will cause refrigerator to run longer in order to maintain desired temperatures.
	Thermostat is keeping the refrigerator at a constant temperature.	This is normal. Refrigerator goes on and off to keep the temperature constant.

Occurrence	Possible cause	Solution
Refrigerator compressor does not run.	Thermostat is keeping the refrigerator at a constant temperature.	This is normal. The refrigerator goes on and off to keep the temperature constant.
Temperatures are too cold		
Temperature in the freezer is too cold but the refrigerator temperature is satisfactory.	Freezer control is set too cold	Set the freezer control to a warmer setting until the freezer temperature is satisfactory.
Temperature in the refrigerator is too cold and the freezer temperature is satisfactory.	Refrigerator control is set too cold.	Set the refrigerator control to a warmer setting
Food stored in drawers freezes.	Refrigerator control is set too cold.	See above solution.
Meat stored in fresh meat drawer freezes.	Meat should be stored at a temperature just below the freezing point of water (32°F, 0°C) for maximum fresh storage time.	It is normal for ice crystals to form due to the moisture content of meat.
Temperatures are too warm		
Temperatures in the refrigerator or freezer are too warm.	Freezer control is set too warm.	Set the freezer or refrigerator control to a colder setting until the freezer or refrigerator temperature is satisfactory.
	Refrigerator control is set too warm. Refrigerator control has some effect on freezer temperature.	Set the freezer or refrigerator control to a colder setting until the freezer or refrigerator temperature is satisfactory.
	Doors are opened too frequently or too long.	Warm air enters the refrigerator/ freezer whenever the door is opened. Open the door less often.
	Door is slightly open.	Close the door completely.
	Large amounts of warm or hot food may have been stored recently.	Wait until the refrigerator or freezer has a chance to reach its selected temperature.
	Refrigerator has recently been disconnected for a period of time.	A refrigerator requires some hours to cool down completely.
Temperature in the refrigerator is too warm but the freezer temperature is satisfactory.	Refrigerator control is set too warm.	Set the refrigerator control to a colder setting.

Occurrence	Possible cause	Solution
Sound and noise		
Louder sound levels when refrigerator is on.	Today's refrigerators have increased storage capacity and maintain more even temperatures.	It is normal for sound levels to be higher.
Louder sound levels when compressor comes on.	Refrigerator operates at higher pressures during the start of the ON cycle.	This is normal. The sound will level off as the refrigerator continues to run.
Vibrating or rattling noise.	Floor is uneven or weak. Refrigerator rocks on the floor when it is moved slightly.	Be sure floor is level and solid and can adequately support refrigerator.
	Items placed on the top of the refrigerator are vibrating.	Remove items.
	Dishes are vibrating on the shelves in the refrigerator.	It is normal for dishes to vibrate slightly. Move dishes slightly. Make sure refrigerator is level and firmly set on floor.
	Refrigerator is touching wall or cabinets.	Move refrigerator so that it does not touch the wall or refrigerator.
Water/Moisture /Ice inside refrigerator		
Moisture collects on the inside walls of the refrigerator.	The weather is hot and humid which increases the rate of frost buildup and internal sweating.	This is normal.
	Door is slightly open.	See problem section opening/closing of doors.
	Door is opened too often or too long.	Open the door less often.
Water/Moisture /Ice outside refrigerator		
Moisture forms on the outside of the refrigerator or between doors.	Weather is humid.	This is normal in humid weather. When humidity is lower, the moisture should disappear.
	Door is slightly open, causing cold air from the inside the refrigerator to meet warm air from the outside.	This time, close the door completely.

Occurrence	Possible cause	Solution
Odors in refrigerator	Interior needs to be cleaned.	Clean interior with sponge,warm water and baking soda.
	Food with strong odor is in the refrigerator.	Cover food completely.
	Some containers and wrapping materials produce odors.	Use a different container or brand of wrapping materials.
Opening/Closing of doors/Drawers		
Door(s) will not close.	Food package is keeping door open.	Move packages that keep door from closing.
Door(s) will not close.	Door was closed too hard, causing other door to open slightly.	Close both doors gently.
	Refrigerator is not level. It rocks on the floor when it is moved slightly.	Adjust the height adjusting screw.
	Floor is uneven or weak. Refrigerator rocks on the floor when it is moved slightly.	Be sure floor is level and can adequately support refrigerator. Contact carpenter to correct sagging or sloping floor.
	Refrigerator is touching wall or cabinets.	Move refrigerator..
Drawers are difficult to move.	Food is touching shelf on top of the drawer	Keep less food in drawer.
	Track that drawer slides on is dirty.	Clean drawer and track.
Dispenser		
Dispenser will not dispense ice	Ice storage bin is empty.	When the first supply of ice is dropped into the bin, the dispenser should operate.
	Freezer temperature is set too warm.	Turn the freezer control to a higher setting so that ice cubes will be made. When the first supply of ice is made, the dispenser should operate.
	Household water line valve is not open.	Open household water line valve and allow sufficient time for ice to be made. When ice is made, dispenser should operate.
	Refrigerator or freezer door is not closed.	Be sure both doors are closed.

Occurrence	Possible cause	Solution
Dispenser will not dispense ice.	Ice has melted and frozen around auger due to infrequent use, temperature fluctuations and/or power outages.	Remove ice storage bin, and thaw and the contents. Clean bin, wipe dry and replace in proper position. When new ice is made, dispenser should operate.
Ice dispenser is jammed.	Ice cubes are jammed between the ice maker arm and back of the bin.	Remove the ice cubes that are jamming the dispenser.
	Ice cubes are frozen together.	Use the dispenser often so that cubes do not freeze together.
	Ice cubes that have been purchased or made in some other way have been used in the dispenser.	Only the ice cubes made by the ice maker should be used with the dispenser.
Dispenser will not dispense water.	Household water line valve is not open. See problem "Icemaker is not making any ice."	Open household water line valve.
	Refrigerator or freezer door is not closed.	Be sure both doors are closed.
Water has an odd taste and/or odor.	Water has been in the tank for too long.	Draw and discard 7 glasses of water to freshen the supply. Draw and discard an additional 7 glasses to completely rinse out tank.
	Unit not properly connected to cold water line.	Connect unit to cold water line which supplies water to kitchen faucet.
Sound of ice dropping	This sound is normally made when ice is dropped into ice storage bin. Volume may vary according to refrigerator's location.	
Sound of water supply	This sound is normally made when ice maker is supplied with water after dropping the ice.	
Other	Please thoroughly read 'Automatic icemaker and dispenser' in this manual.	

LG ELECTRONICS, INC.
LG REFRIGERATOR LIMITED WARRANTY - USA



Your LG Refrigerator will be repaired or replaced, at LG's option, if it proves to be defective in material or workmanship under normal use, during the warranty period ("Warranty Period") set forth below, effective from the date ("Date of Purchase") of original consumer purchase of the product. This warranty is good only to the original purchaser of the product and effective only when used in the United States, including Alaska, Hawaii, and U.S. Territories.

<p><u>WARRANTY PERIOD:</u></p> <p>REFRIGERATOR/FREEZER</p> <p>LABOR: One Year from the Date of Purchase.</p> <p>PARTS: One Year from the Date of Purchase.</p> <p>SEALED SYSTEM (Compressor, Condenser, and Evaporator)</p> <p>LABOR: One Year from the Date of Purchase.</p> <p>PARTS: Seven years from the Date of Purchase.</p> <p>Replacement Units and Repair Parts are warranted for the remaining portion of the original unit's warranty period.</p>	<p><u>HOW SERVICE IS HANDLED:</u></p> <p>In-Home Service (Except Model GR051):</p> <p>Please retain dealer's dated bill of sale or delivery ticket as evidence of the Date of Purchase for proof of warranty, and submit a copy of the bill of sale to the service person at the time warranty service is provided.</p> <p>Please call 1-800-243-0000 and choose the appropriate option to locate your nearest LG Authorized Service Center. (Phones are answered 24 hours a day, 365 days per year.)</p> <p>Or visit our website at: http://www.lgservice.com</p>
---	--

THIS WARRANTY IS IN LIEU OF ANY OTHER WARRANTY, EXPRESS OR IMPLIED, INCLUDING WITHOUT LIMITATION, ANY WARRANTY OF MERCHANTABILITY OR FITNESS FOR A PARTICULAR PURPOSE. TO THE EXTENT ANY IMPLIED WARRANTY IS REQUIRED BY LAW, IT IS LIMITED IN DURATION TO THE EXPRESS WARRANTY PERIOD ABOVE. NEITHER THE MANUFACTURER NOR ITS U.S. DISTRIBUTOR SHALL BE LIABLE FOR ANY INCIDENTAL, CONSEQUENTIAL, INDIRECT, SPECIAL, OR PUNITIVE DAMAGES OF ANY NATURE, INCLUDING WITHOUT LIMITATION, LOST REVENUES OR PROFITS, OR ANY OTHER DAMAGE WHETHER BASED IN CONTRACT, TORT, OR OTHERWISE. Some states do not allow the exclusion or limitation of incidental or consequential damages or limitations on how long an implied warranty lasts, so the above exclusion or limitation may not apply to you. This warranty gives you specific legal rights and you may also have other rights that vary from state to state.

THIS LIMITED WARRANTY DOES NOT APPLY TO:

- Service trips to your home to deliver, pick up, and/or install the product, instruct, or replace house fuses or correct wiring, or correction of unauthorized repairs.
- Damages or operating problems that result from misuse, abuse, operation outside environmental specifications or contrary to the requirements of precautions in the Operating Guide, accident, vermin, fire, flood, improper installation, acts of God, unauthorized modification or alteration, incorrect electrical current or voltage, or commercial use, or use for other than intended purpose.
- Repairs when your LG refrigerator is used in other than normal, single-family household use.

The cost of repair or replacement under these excluded circumstances shall be borne by the consumer.

CUSTOMER INTERACTIVE CENTER NUMBERS

<p>To obtain Customer Assistance, Product Information, or Dealer or Authorized Service Center location:</p>	<p>Call 1-800-243-0000 (24 hours a day, 365 days per year) and select the appropriate option from the menu.</p> <p>Or visit our website at: http://www.lgservice.com</p>
--	---

TO CONTACT LG ELECTRONICS BY MAIL:

LG Customer Interactive Center
P. O. Box 240007
201 James Record Road
Huntsville, Alabama 35824
ATTN: CIC

Free Manuals Download Website

<http://myh66.com>

<http://usermanuals.us>

<http://www.somanuals.com>

<http://www.4manuals.cc>

<http://www.manual-lib.com>

<http://www.404manual.com>

<http://www.luxmanual.com>

<http://aubethermostatmanual.com>

Golf course search by state

<http://golfingnear.com>

Email search by domain

<http://emailbydomain.com>

Auto manuals search

<http://auto.somanuals.com>

TV manuals search

<http://tv.somanuals.com>