



32LY770M
42LY770M

Hospital Grade Interactive Pro:Centric[®] TVs

Commercial Mode Setup Guide

Note: Selected features shown in this guide may not be available on all models.

EXPERIENCED INSTALLER

LG Setup Wizard
pages 12–13

Custom Master TV Setup
pages 46–48

Cloning Procedures
pages 53–58

For Customer Support/Service, please call:

1-888-865-3026

The latest product information and documentation is available online at:

www.LGolutions.com

MODEL and SERIAL NUMBER

The model and serial numbers of this TV are located on the back of the cabinet. For future reference, LG suggests that you record those numbers here:

Model No. _____ Serial No. _____



WARNING:

TO REDUCE THE RISK OF ELECTRIC SHOCK DO NOT REMOVE COVER (OR BACK). NO USER-SERVICEABLE PARTS INSIDE. REFER TO QUALIFIED SERVICE PERSONNEL.



The lightning flash with arrowhead symbol, within an equilateral triangle, is intended to alert the user to the presence of uninsulated "dangerous voltage" within the product's enclosure that may be of sufficient magnitude to constitute a risk of electric shock to persons.



The exclamation point within an equilateral triangle is intended to alert the user to the presence of important operating and maintenance (servicing) instructions in the literature accompanying the appliance.

WARNING:

TO PREVENT FIRE OR SHOCK HAZARDS, DO NOT EXPOSE THIS PRODUCT TO RAIN OR MOISTURE.

WARNING:

This product contains chemicals known to the State of California to cause cancer and birth defects or other reproductive harm. **Wash hands after handling.**

POWER CORD POLARIZATION:

This product is equipped with a 3-wire grounding-type alternating current power plug. This plug will fit into the power outlet only one way. This is a safety feature. If you are unable to insert the plug fully into the outlet, contact your electrician to replace your obsolete outlet. Do not defeat the safety purpose of the 3-wire grounding-type plug.

NOTE TO CABLE/TV INSTALLER:

This reminder is provided to call the cable TV system installer's attention to Article 820-40 of the National Electrical Code (U.S.A.). The code provides guidelines for proper grounding and, in particular, specifies that the cable ground shall be connected to the grounding system of the building, as close to the point of the cable entry as practical.

REGULATORY INFORMATION:

This equipment has been tested and found to comply with the limits for a Class B digital device, pursuant to Part 15 of the FCC Rules. These limits are designed to provide reasonable protection against harmful interference when the equipment is operated in a residential installation. This equipment generates, uses and can radiate radio frequency energy and, if not installed and used in accordance with the instruction manual, may cause harmful interference to radio communications. However, there is no guarantee that interference will not occur in a particular installation. If this equipment does cause harmful interference to radio or television reception, which can be determined by turning the equipment off and on, the user is encouraged to try to correct the interference by one or more of the following measures:

- Reorient or relocate the receiving antenna.
- Increase the separation between the equipment and receiver.
- Connect the equipment to an outlet on a circuit different from that to which the receiver is connected.
- Consult the dealer or an experienced radio/TV technician for help.

CAUTION:

Do not attempt to modify this product in any way without written authorization from LG Electronics U.S.A., Inc. Unauthorized modification could void the user's authority to operate this product.

COMPLIANCE:

The responsible party for this product's compliance is: LG Electronics U.S.A., Inc.
1000 Sylvan Avenue, Englewood Cliffs, NJ 07632, USA • Phone: 1-201-816-2000

Marketed and Distributed in the United States by LG Electronics U.S.A., Inc.
1000 Sylvan Avenue, Englewood Cliffs, NJ 07632

IMPORTANT SAFETY INSTRUCTIONS

1. Read these instructions.
2. Keep these instructions.
3. Heed all warnings.
4. Follow all instructions.
5. Do not use this apparatus near water.
6. Clean only with dry cloth.
7. Do not block any ventilation openings. Install in accordance with the manufacturer's instructions.
8. Do not install near any heat sources, such as radiators, heat registers, stoves, or other apparatus (including amplifiers) that produce heat.
9. Do not defeat the safety purpose of the polarized or grounding-type plug. A polarized plug has two blades with one wider than the other. A grounding-type plug has two blades and a third grounding prong. The wide blade or the third prong are provided for your safety. If the provided plug does not fit into your outlet, consult an electrician for replacement of the obsolete outlet.
10. Protect the power cord from being walked on or pinched, particularly at plugs, convenience receptacles, and the point where it exits from the apparatus.
11. Only use attachments/accessories specified by the manufacturer.
12. Use only with the cart, stand, tripod, bracket, or table specified by the manufacturer or sold with the apparatus. When a cart is used, use caution when moving the cart/apparatus combination in order to avoid injury from tip-over.



13. Refer all servicing to qualified service personnel. Servicing is required when the apparatus has been damaged in any way, such as power-supply cord or plug is damaged, liquid has been spilled or objects have fallen into the apparatus, the apparatus has been exposed to rain or moisture, does not operate normally, or has been dropped.
14. Never touch this apparatus or antenna during a thunder or lightning storm.
15. When mounting a TV on the wall, make sure not to install the TV by the hanging power and signal cables on the back of the TV.
16. Do not allow an impact shock or any objects to fall into the product, and do not drop objects onto the screen.

17. Power Cord

Caution: It is recommended that appliances be placed upon a dedicated circuit; that is, a single outlet circuit which powers only that appliance and has no additional outlets or branch circuits. Check the TV specifications.

Periodically examine the cord of your appliance, and if its appearance indicates damage or deterioration, unplug it, discontinue use of the appliance, and have the cord replaced with an exact replacement part by an authorized servicer. Protect the power cord from physical or mechanical abuse, such as twisting, kinking, or pinching or being closed in a door or walked upon. Pay particular attention to plugs, wall outlets, and the point where the cord exits the appliance.

Do not use a damaged or loose power cord. Be sure to grasp the plug when unplugging the power cord. Do not pull on the power cord to unplug the TV.

18. Overloading

Do not connect too many appliances to the same AC power outlet as this could result in fire or electric shock. Do not overload wall outlets. Overloaded wall outlets, loose or damaged wall outlets, extension cords, frayed power cords, or damaged or cracked wire insulation are dangerous. Any of these conditions could result in fire or electric shock.

19. Outdoor Use/Wet Location



Warning: To reduce the risk of fire or electrical shock, do not expose this product to rain, moisture or other liquids.

Do not touch the TV with wet hands. Do not install this product near flammable objects such as gasoline or candles or expose the TV to direct air conditioning.

Do not expose to dripping or splashing and do not place objects filled with liquids, such as vases, cups, etc., on or over the apparatus (e.g., on shelves above the unit).

20. Grounding

Ensure that you connect the earth ground wire to prevent possible electric shock (i.e., a TV with a three-prong grounded AC plug must be connected to a three-prong grounded AC outlet). If grounding methods are not possible, have a qualified electrician install a separate circuit breaker. Do not try to ground the unit by connecting it to telephone wires, lightning rods, or gas pipes.

21. Disconnect Device

The mains plug is the disconnecting device. The plug must remain readily operable.

As long as this unit is connected to the AC wall outlet, it is not disconnected from the AC power source even if you turn off this unit by SWITCH.

(Continued on next page)

IMPORTANT SAFETY INSTRUCTIONS

(Continued from previous page)

22. Outdoor Antenna Grounding

If an outside antenna or cable system is connected to the product, follow the precautions below.

An outdoor antenna system should not be located in the vicinity of overhead power lines or other electric light or power circuits or where it can come into contact with such power lines or circuits as death or serious injury can occur.

Be sure the antenna system is grounded so as to provide some protection against voltage surges and built-up static charges.

Article 810 of the National Electrical Code (NEC) in the U.S.A. provides information with respect to proper grounding of the mast and supporting structure, grounding of the lead-in wire to an antenna-discharge unit, size of grounding conductors, location of antenna-discharge unit, connection to grounding electrodes, and requirements for the grounding electrode.

Antenna Grounding According to NEC, ANSI/NFPA 70

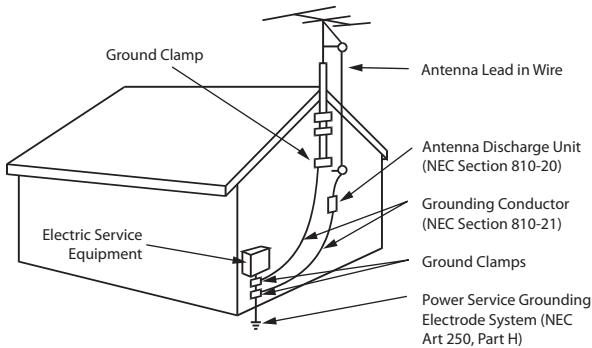

23. Cleaning

When cleaning, unplug the power cord and wipe gently with a soft cloth to prevent scratching. Do not spray water or other liquids directly on the TV as electric shock may occur. Do not clean with chemicals such as alcohol, thinners or benzene.

24. Transporting Product

Make sure the TV is turned Off and unplugged and that all cables have been removed. It may take two or more people to carry larger TVs. Do not press against or put stress on the front panel of the TV during transport.

25. Ventilation

Install the TV where there is proper ventilation. Do not install in a confined space such as a bookcase. Do not cover the TV with cloth or other materials (e.g., plastic) while it is plugged in. Do not install in excessively dusty places.

- 26. Do not touch the ventilation openings, as they may become hot while the TV is operating.
- 27. If you smell smoke or other odors coming from the TV or hear strange sounds, unplug the power cord, and contact an authorized service center.
- 28. Do not press against the front panel of the TV with your hand or a sharp object (e.g., a nail, pencil, or pen) or make a scratch on it.
- 29. Keep the product away from direct sunlight.

30. Dot Defect

The LCD panel is a high technology product with resolution of two million to six million pixels. In a very few cases, you could see fine dots on the screen while you are viewing the TV. Those dots are deactivated pixels and do not affect the performance and reliability of the TV.

31. Generated Sound

“Cracking”: A cracking noise that occurs while the TV is On or when it is turned Off is generated by plastic thermal contraction due to temperature and humidity. This noise is common for products where thermal deformation is required.

Electrical circuit humming/panel buzzing: A low level noise is generated from a high-speed switching circuit, which supplies a large amount of current to operate a product. It varies depending on the product. This generated sound does not affect the performance and reliability of the product.

32. For LCD TV

If the TV feels cold to the touch, there may be a small “flicker” when it is turned On. This is normal; there is nothing wrong with the TV. Some minute dot defects may be visible on the screen, appearing as tiny red, green, or blue spots. However, they have no adverse effect on the TV’s performance. Avoid touching the LCD screen or holding your finger(s) against it for long periods of time. Doing so may produce some temporary distortion effects on the screen.

Table of Contents

Safety Warnings	2	Channel Banks Worksheet	52
Important Safety Instructions	3–4	Cloning Procedures	53–58
Table of Contents	5	Learning Configuration from a Master TV	53
Commercial Mode Overview	6–9	Teaching Configuration to a Target TV	55
Setup Checklist	6	FTG File Manager Utilities Overview	59–64
Pass-through Mode	6	Creating an FTG Configuration File	59
FTG Mode	7	FTG File Manager Main Screen	61
Determining the TV Operating Mode	9	FTG Channel Map Configuration Utility	62
Pro:Centric Operation	10–11	FTG Channel Map Editor	63
Pro:Centric Interactive Menu Features	10	FTG Installer Menu Configuration Utility	64
Pro:Centric Interactive Menu Navigation	10	IP Environment Setup	65–72
Pro:Centric Setup	11	Accessing the IP Environment Menu	65
LG Setup Wizard	12–13	Pro:Centric Setup	65
Before You Begin	12	Network Configuration	67
Initiate Configuration or Exit the LG Setup Wizard	13	Pre-loaded Applications	72
EZ-Manager Wizard	14–22	References	
Initiate the EZ-Manager Wizard	14	Updating TV/PTC Software using a USB Memory Device	73–74
TV Configuration Options	15	Downloading a Splash Screen Image using a USB Memory Device	75–76
Zones and Room Number Assignments	15	Power Consumption Settings	77
Configure Pro:Centric Settings	17	TV Aux Input Configuration	78
USB Configuration	21	b-LAN Setup & Overview	79
Express Script	23–30	FTG Mode via EBL (Local Configuration)	80
Initiate the Express Script	23	Auto Input(s) Sensing Feature	81
Configure Pro:Centric Settings	25	LY770M Hospital Operations	82–83
Complete the TV Configuration	28	Restoring Factory Defaults on the TV(s)	84
Ez Download Utility	31–34	Using the TV's Zoning Features	85–88
Before You Begin	31	Using Media Share Features	89–90
Accessing and Using the Ez Download Utility	31	LY770M Rear and Side Jack Panels	91
Installer Menu	35–45	External Stereo Speaker Specifications	92
Accessing the Installer Menu	35	Installer Remote Control Typical Key Functions	93
Using the Installer Menu	36	Pro:Centric Pillow Speaker and Patient Remote Options	94
Exiting the Installer Menu and Activating Settings	36	Pillow Speaker Setup	95
Custom Master TV Setup	46–48	VESA Standard TV Mounts	96
Before You Begin	46	Troubleshooting	97–99
Clonable TV Setup Menu Features	46	General Troubleshooting	97
Custom Master TV Setup Procedure	47	Commercial Mode Check / FTG Operation Troubleshooting	98
Channel Banks Setup	49–51	Channel Banks Setup Troubleshooting	99
Channel Banks Overview	49	Glossary of Terms	100
Before You Begin	49	Document Revision History / Open Source Software Notice	101
Accessing the Channel Preview/Banks Setup Menu	49	Back Cover	102
Channel Status Options	50		
Selecting the Channel Status	50		
Inactive TV Setup	51		
Channel Banks Worksheets	51		

Notes

- Installer Menu content is intended for use primarily by qualified TV electronics technicians.
- Refer to the applicable Owner's Manual for additional information on TV installation, specifications, maintenance, and safety instructions.
- Design and specifications subject to change without prior notice. This document provides examples of typical TV displays. Your displays may vary from those shown in this document.

Commercial Mode Overview

This document describes how to set up LY770M Pro:Centric® TVs for Commercial Mode operation. LG commercial TV functionality is based on “ownership” of the Channel Map; that is, the Channel Map resides in the TV’s CPU, Protocol Translator Card (PTC), or embedded *b*-LAN™ (EBL) module, or it resides externally from the TV (i.e., in a device from the solution provider).

These TV models are capable of Free-To-Guest (FTG) Mode operation via the TV CPU. Alternatively, the EBL module can be configured either for Pass-through Mode (default) or FTG Mode. When neither the CPU nor EBL is in FTG Mode, these TV models also allow external control via the TV’s MPI port.

Setup Checklist

Note: This document provides information specific to Commercial Mode operation. Refer to the Owner’s Manual for information on TV installation and hardware and cable connections.

Installation

- ___ Unpack TV and all accessories.
- ___ Install batteries in the Installer Remote.
- ___ Install TV on VESA mount or stand.
Note: It may be advisable to make all cable connections before installing on VESA mount or stand, as appropriate.

Cable Connections

- ___ Make all rear jack panel connections, as appropriate.

Commercial Mode Setup

- ___ Complete appropriate procedures as described in this document for Commercial Mode operation.

Hardware Connections

- ___ Install any additional hardware as appropriate to your institution, LAN, etc.

Pass-through Mode

This mode allows you to configure individual TVs for Pro:Centric and/or FTG Mode via CPU operation or create a Master TV Setup for cloning purposes. This mode also allows external control via the GAME CONTROL/MPI port on the TV rear jack panel.

There are three methods for configuring individual TVs that are currently in Pass-through Mode: using one of two LG Setup Wizard options or using the Custom Master TV Setup procedure as described in this document.

LG Setup Wizard Configuration

When the TV is in a factory default state, the LG Setup Wizard provides the following two configuration options:

- The EZ-Manager Wizard provides automated or manual options for configuring essential items for Pro:Centric operation and also provides an option for using a USB memory device to configure the TV. Use the Installer Remote to make selections and complete each step.
- The Express Script provides limited customization of the TV features and Installer Menu items, confined to those that are essential to most hospital TV viewing applications.

See “LG Setup Wizard” on pages 12 to 13 for further information.

Custom Master TV Setup

The Custom Master TV Setup procedure enables you to create a customized Master TV Setup for Pass-through Mode or FTG Mode via CPU configuration purposes. Use the Installer Remote to configure Installer Menu items as required for TV operation and set up TV features (Channel, Picture, Sound, etc.). See “Custom Master TV Setup” on pages 46 to 48 for detailed information.

Installer Menu

To create a Master TV Setup, you will need to know how to access the commercial controller (PTC) Installer Menu and make changes to the default values as required. If necessary, familiarize yourself with the Installer Menu and how to make and save changes. Refer to pages 35 to 45 for information on accessing the Installer Menu and for detailed descriptions of the Installer Menu items.

TV Setup Menus

On-screen setup menus control the features of the TV. Use the Installer Remote to access the TV setup menus, and set the TV features to the desired configuration for the end user.

Cloning

Cloning refers to the process of capturing a Master TV Setup and transferring it to a Target TV. The Master TV's clonable setup menu features should be configured as part of the Master TV Setup. If there are features in the Master TV's setup—channel icons or labels, digital font options, etc.—that are not set or that are set incorrectly, those features also will not be set or will be set incorrectly in the Target TVs. Refer to pages 53 to 58 for detailed information on cloning requirements and procedures.

External MPI Control

To control the TV using an external MPI control device, you must use the TV's GAME CONTROL/MPI port for communication purposes. In these TVs, Installer Menu item 118 POWER SAVINGS controls the power circuitry for both the embedded b-LAN module and the GAME CONTROL/MPI port; therefore, to ensure that the GAME CONTROL/MPI port circuitry is powered, thus enabling MPI communication, Installer Menu item 118 POWER SAVINGS must be set appropriately. See Installer Menu item descriptions as well as Reference section, "b-LAN Setup & Overview," for further information.

Note: These TV models are not equipped with MPI card slots.

FTG Mode

In this mode, an FTG Channel Map enables the decryption of each Pro:Idiom[®] encrypted channel. The FTG Channel Map also provides logical channel mapping of physical RF channels (analog and digital), IP channels, and Aux inputs. The method for creating the FTG Channel Map is ultimately determined by which element of the TV will "own" the FTG Channel Map—the CPU or the EBL.

For these TV models, there are two FTG Modes—FTG Mode via CPU and FTG Mode via EBL—which are separate and distinct FTG Modes of operation, each with its own unique advantages and requirements, as outlined on the following page.

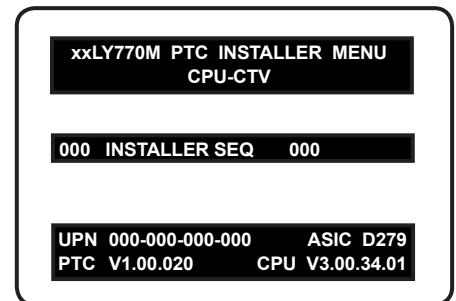

Typical Installer Menu

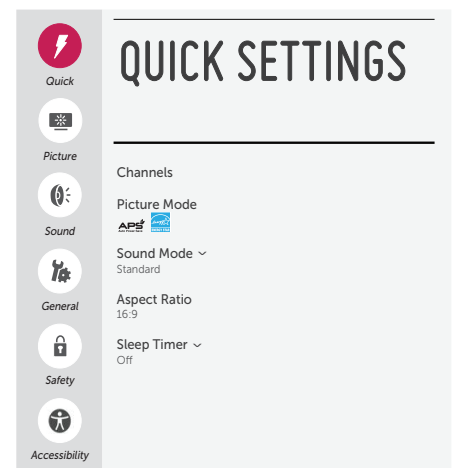

TV Setup Menus

Commercial Mode Overview (Cont.)

When the TV CPU is configured with an FTG Channel Map, the CPU controls and restricts the tuning operation of the TV, and when the EBL is configured with an FTG Channel Map, the EBL controls and restricts the tuning operation of the TV. In these models, depending on the types of channels included in the FTG Channel Map, FTG Mode via CPU also provides the option to select either logical or physical tuning during configuration (refer to “Teaching Configuration to a Target TV” on pages 55 to 58 and also see notes below). You must determine which element of the TV will own the FTG Channel Map before you can begin configuration.

Note: Logical channel mapping of physical RF channels eliminates dash tuning; for example, physical 19-3 can be mapped to logical channel 9. It also allows physical RF channels, IP channels, and Aux inputs to be listed in any order, not only in physical numeric ascending order. Physical channel tuning requires that you include the dash when direct entering RF channel numbers and Aux inputs (the latter designated by 130-0 through 137-0).

Note: Physical channel tuning is not available when IP channels are included in the FTG Channel Map.

FTG Mode via CPU

This mode provides the following features:

- Logical or physical tuning of physical RF channels and Aux inputs.
- Logical tuning of IP channels.
- Mapping of RF channels with minor (program) numbers up to 999.
- FTG Channel Map of up to 600 channels.
- Start Channel set for RF, Aux input, or IP delivered content.
- Pro:Centric data delivery over RF or IP.
- TV Zoning and Wi-Fi Zoning options for location-specific configuration.

LG’s FTG File Manager PC software enables you to create an FTG Configuration (.tlx) file, which may be used to configure the CPU for FTG Mode. You can also save (Learn) a TLX file from a Master TV. In this mode, the CPU is the owner of the FTG Channel Map and must be configured with an FTG Channel Map and FTG Installer Menu settings using one of the following processes:

- Local: Configure an individual LY770M TV via its USB port using a USB memory device / TLX file. The “Teach to TV (TLX)” process and associated procedures are described on pages 53 to 58.
- Remote: Configure all LY770M TVs at the site using a Pro:Centric server head end device (Example: PCS150R). Refer to the **Pro:Centric Server Admin Client User Guide** for further information.

FTG Mode via EBL

This mode provides the following features:

- Logical tuning of physical RF channels and Aux inputs.
- Mapping of RF channels with minor (program) numbers up to 255.
- FTG Channel Map of up to 141 logical channels.
- Start Channel set for RF or Aux input delivered content.
- Pro:Centric data delivery over RF.

LG’s FTG Device Configuration Application PC software is required to configure the EBL. In this mode, the EBL is the owner of the FTG Channel Map and must be configured with an FTG Channel Map and FTG Installer Menu settings using one of the following processes:

- Local: Configure an individual LY770M TV’s EBL via its TV-LINK CFG jack using a direct PC-to-TV connection and the FTG Device Configuration Application. See Reference section, “FTG Mode via EBL (Local Configuration),” for information on the “Write” process for an FTG Channel Map and FTG Installer Menu settings.
- Remote: Configure all LY770M TV EBLs at the site using a Free-To-Guest Management Appliance (FMA) head end device (Example: FMA-LG101). Refer to the **Free-To-Guest (FTG) Device Configuration Application User Guide** and/or the Installation & Configuration Guide for the FMA device for further information.

While the TV is in FTG Mode:

- Users can still access the Installer Menu using an LG Installer Remote; however, all Installer Menu items will be read-only.
- FTG Mode via CPU configuration changes must be made using a TLX file (typically edited in the FTG File Manager), while FTG Mode via EBL configuration changes must be made using the the FTG Device Configuration Application. FTG Channel Map Configuration and FTG Installer Menu Configuration utilities in both PC applications enable you to make changes, respectively, to the FTG Channel Map and FTG Installer Menu settings as necessary. Based on the initial method used to configure the TV for FTG Mode operation (via CPU or EBL), all subsequent changes must be transferred to either the TV CPU or the EBL via a process that is in accordance or compatible with that method (see information on local configuration in this document or refer to documentation for the head end device/server for information on remote management).
- If it becomes necessary to restore the TV to Pass-through Mode, there are several options that will enable you to do so. See Reference section, “Restoring Factory Defaults on the TV(s),” for further information.

Pages 59 to 64 provide overviews of the utilities that comprise the FTG File Manager. Refer to the **Free-To-Guest (FTG) File Manager User Guide** for further information on the FTG File Manager. Refer to the **Free-To-Guest (FTG) Device Configuration Application User Guide** for information on the FTG Device Configuration Application.

Remote Management in FTG Mode

When the TV is configured for FTG Mode via CPU, remote management of the FTG Channel Map and FTG Installer Menu settings is provided by a Pro:Centric server, via a TLX file loaded on the Pro:Centric server Admin Client. Refer to the **Pro:Centric Server Admin Client User Guide** for further information.

When the TV is configured for FTG Mode via EBL, the *b*-LAN module, which is internal to the TV, allows hotel/institution head end equipment (for example, an FMA-LG101) with *b*-LAN technology to provide remote management of the FTG Channel Map and FTG Installer Menu settings. See Reference section, “*b*-LAN Setup & Overview,” for further information.

Determining the TV Operating Mode

To determine the operating mode of the TV, press **MENU** on the Installer Remote. The menu displayed depends on the operating mode. See examples below.

If the Function Menu appears, the TV is in a mode (FTG, PPV, etc.) that does not allow the end user to change the fundamental TV setup. If the TV setup menu appears, the TV is in Pass-through Mode.



Function Menu
Indicates the TV is not in Pass-through Mode. While the TV is in this mode, Installer Menu settings can be accessed as read-only.

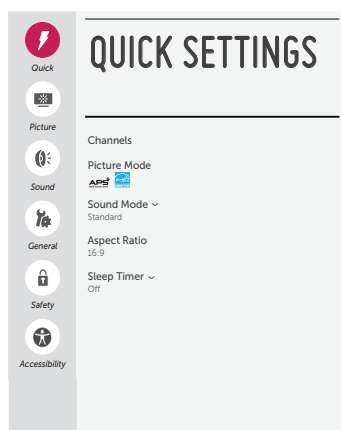

TV Setup Menus
Shows that the TV is in Pass-through Mode.

Pro:Centric Operation

Pro:Centric Interactive Menu Features

LG's Pro:Centric application enables patients and visitors to locate and select television entertainment using an interactive channel guide, check the daily weather, and view hospital and surrounding amenities via custom billboards and points-of-interest maps.

Pro:Centric application features include:

- Portal and information screens/pages (including a "Welcome" page) that include branding logos.
- An optional customized user interface (custom "skins").
- Billboards and points-of-interest maps, which can be customized to focus on hospital amenities, local attractions and businesses, hotels, restaurants, news, events, etc.
- An optional Weather billboard that includes a local radar map, current conditions, and a four day forecast.
- An interactive channel guide that provides a channel list with channel icons. An electronic program guide (EPG) is an optional feature that displays up to three days of programming information viewable by channel and time.
- Video spooling that enables the hospital to deliver a video file to patient and visitor TVs for promotion and information purposes.

The Pro:Centric server Admin Client web editor/content wizard is provided for customer configuration of portal messages and billboards/maps.

Note: Customized content is typically defined by the service integrator and/or hospital administrators. LG does not provide hospital-specific content.

Pro:Centric Interactive Menu Navigation

LG's Pro:Centric pillow speaker provides access to both interactive menus and regular TV features. Press **PORTAL** on the Pro:Centric pillow speaker to access the interactive menus.

Note: Interactive menu options may vary, depending on Pro:Centric features enabled for the site. The following are default interactive menus.



Channel Guide

Shows available TV networks and logical channels. When available, EPG data provides additional channel and program information.

Information

Typically displays information on hospital and nearby amenities, for example, restaurants, cafeterias, facilities, etc., as well as information on local weather.

Help

Provides help for navigating the interactive menus.

Watch TV

Removes the interactive menu from the screen and returns to the previously tuned TV channel.

Pro:Centric Setup

Administration and management options for the Pro:Centric server are described in detail in the *Pro:Centric Server Admin Client User Guide*. This document describes only those settings that must be specified on the TVs to enable Pro:Centric remote management and/or the Pro:Centric application.

- Remote management (TV E-Z Installation): The Pro:Centric server Admin Client provides remote management facilities for downloading splash screen image and software/firmware updates as well as facilities for downloading a TLX file for FTG Mode via CPU configuration.
- Pro:Centric application: The application, which operates in conjunction with FTG and PPV Modes, comprises the Pro:Centric interactive menus/features described on the previous page. Pro:Centric application settings are managed via the Pro:Centric server Admin Client.

The Pro:Centric server settings can be configured using one of the methods described below.

Note: If using a Pro:Centric pillow speaker, also set Installer Menu item 027 HOSPITAL MODE to the required value.

TV in Factory Default State

When the TV is in a factory default state, LG's Setup Wizard (see pages 12 to 13) provides automated or manual options for configuring the Pro:Centric server settings. The EZ-Manager branch of the Setup Wizard also provides a USB configuration option that enables you to configure a TV for FTG Mode via CPU using a TLX file stored on a USB memory device. The TLX file incorporates FTG Installer Menu settings, which includes Installer Menu items 098 PRO:CENTRIC and 119 DATA CHANNEL.

Note: If Pro:Centric data delivery will be over IP, there is a DNS server at the site, and you intend to use the EZ-Manager Wizard to set up the TV, you can create a DNS entry "procentric.local" for the Pro:Centric server that will enable automated Pro:Centric IP configuration via the wizard. If there is no DNS entry for procentric.local, you will need to manually enter the Pro:Centric server IP address and port number during configuration.

TV in Pass-through Mode

If the TV is in Pass-through Mode, either:

- Set Installer Menu items 098 PRO:CENTRIC and 119 DATA CHANNEL to the appropriate values. See Installer Menu information on pages 35 to 45 for further details. Also, as necessary, refer to "Custom Master TV Setup" on pages 46 to 48 and/or cloning information on pages 53 to 58.
- Configure the appropriate Pro:Centric server settings in the IP Environment / Pro:Centric Menu. You must use this option, in particular, if you wish to configure IP settings for the Pro:Centric server. See "Accessing the IP Environment Menu" on page 65 and "Pro:Centric Setup" on pages 65 to 67 for further information.

Note: When the TV is in either Pass-through Mode or FTG Mode via CPU, you can also leave Installer Menu item 119 DATA CHANNEL set to its default value (255) to enable the TV's Data Channel Auto Search feature to set the DATA CHANNEL value. See item 119 description on page 44 for additional information.

TV in FTG Mode

If the TV is in FTG Mode (via CPU or EBL), use the appropriate FTG application software to update Installer Menu items #98 Pro:Centric and #119 Data Channel (along with their affiliated fields). Then, transfer the FTG Installer Menu settings to the TV in accordance with the FTG Mode of configuration. Refer to the FTG Mode overview on pages 7 to 9 for further information on FTG Mode operation and configuration. Also—for FTG Mode via CPU only—see note above regarding the option to use the TV's Data Channel Auto Search feature to set the DATA CHANNEL value.

LG Setup Wizard

Note: After it is turned ON, the TV begins an initialization process, and it may take several minutes for the LG Setup Wizard to appear.

The LG Setup Wizard, comprising EZ-Manager Wizard and Express Script configuration options, will appear on the screen each time the TV is turned ON, until one of its configuration methods has been completed or the wizard is exited. Use the Installer Remote to make selections and complete each step.

- The primary purpose of the EZ-Manager Wizard is to guide you through the process (automated or manual) of configuring the essential Installer Menu items for Pro:Centric operation. However, while intended primarily for Pro:Centric-related configuration, the EZ-Manager Wizard also offers Zoning options. LY770M TVs support the TV Zoning and Wi-Fi Zoning features, both of which enable location-specific settings (see Reference section, “Using the TV’s Zoning Features,” for further information). The EZ-Manager Wizard enables you to set the TV Zone # and/or the Wi-Fi Zone # in the TV as part of the configuration process.
- The EZ-Manager Wizard also enables you to redirect to the TV’s standard TV Manager / USB Download Menu as part of the configuration process, if desired, to perform USB configuration and/or update functions.
- The Express Script guides you through the process of setting up the essential items for most hospital TV viewing applications and also enables you to configure the Pro:Centric settings on the TV. Note that the Express Script uses the TV’s standard RF Auto Tuning feature to create the TV’s channel lineup; IP channels are not supported.



Caution: Do NOT unplug the TV power cord or remove the antenna cable or, if applicable, the LAN cable during the configuration process, as doing so will interrupt the current step and may corrupt the configuration data.



Note: If you do not intend to complete the Express Script, but you wish to enable pillow speaker functionality, you must set Installer Menu item 027 HOSPITAL MODE appropriately. See the “Installer Menu” section of this document for further information.

Before You Begin

- If you plan to create a customized Master TV Setup using the procedure described on pages 46 to 48, be sure to exit the LG Setup Wizard in order to avoid setup conflicts or setting modes that may cause the TV to malfunction or restrict the custom setup procedure. See also “Initiate Configuration or Exit the LG Setup Wizard” on the following page.
- If it has been completed or exited and therefore does not display, the Setup Wizard can be reactivated; however, this requires that you restore the TV to a factory default condition. See Reference section, “Restoring Factory Defaults on the TV(s),” for further information.
- If you wish to enable media sharing (i.e., Smart Share, Screen Share, and DMR) on the TV without using a TLX file for configuration purposes, you will need to create a custom Master TV Setup and use the IP Environment Menu to specify the settings. Custom Master TV Setup is described on pages 46 to 48. Refer to “IP Environment Setup” on pages 65 to 72 for information on the IP Environment Menu.

Initiate Configuration or Exit the LG Setup Wizard

The Welcome screen provides a brief introduction to the LG Setup Wizard.

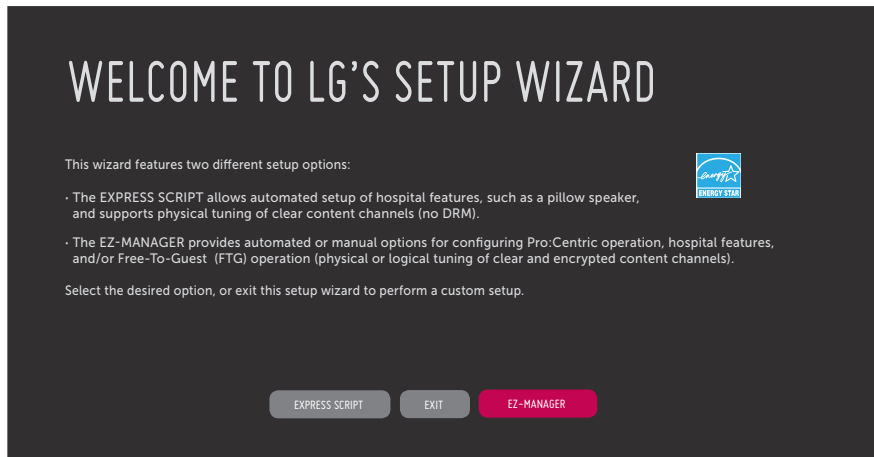

Note: Once you proceed with one of the configuration options, it is not possible to return to the Setup Wizard Welcome screen; however, if you simply wish to exit the EZ-Manager Wizard or Express Script (depending on your selection from the Setup Wizard Welcome screen), you can do so by selecting the “EXIT” button from the subsequent screen(s).

From the Welcome screen, you have the following options:

- To proceed with the EZ-Manager Wizard, use the arrow keys on the Installer Remote to select/highlight **EZ-MANAGER** and press **OK**. Then, continue to the “EZ-Manager Wizard” section on pages 14 to 22.
- To proceed with the Express Script, use the arrow keys on the Installer Remote to select/highlight **EXPRESS SCRIPT** and press **OK**. Then, continue to the “Express Script” section on pages 23 to 30.
- To exit the Setup Wizard, use the arrow keys on the Installer Remote to select/highlight **EXIT** and press **OK**. In the confirmation pop-up window, select **OK**, and then press **OK** once more on the Installer Remote.

Note: Both the EZ-Manager Wizard and the Express Script enable you to configure Pro:Centric settings on this TV, even if you do not intend to configure any of the additional settings available. After you configure the Pro:Centric settings, you will have the option to exit without completing the remainder of the EZ-Manager Wizard or Express Script (as applicable), if desired.

Note: If you exit the Setup Wizard from this Welcome screen, you will retain the use of the Pro:Centric remote management feature on this TV (i.e., Installer Menu item 119 DATA CHANNEL set to 255) in the future. If you actually wish to disable the Pro:Centric feature, both the EZ-Manager Wizard and the Express Script provide an option to do so.

EZ-Manager Wizard

Initiate the EZ-Manager Wizard

After you select the “EZ-Manager” option from the Setup Wizard Welcome screen, an EZ-Manager Welcome screen provides a brief introduction to the EZ-Manager Wizard.

Note: Each EZ-Manager Wizard step is allotted a time frame after which the wizard proceeds without user interaction. If the Pro:Centric server is configured on the system and if no location-specific settings are required in the TV, for example, TV Zone, Wi-Fi Zone, Label, and/or Room Number settings, from this point, the wizard can proceed through each of the configuration steps with no further user interaction.



Note: If there is no user action in this screen within 10 seconds, the wizard will proceed to the next configuration step. Once the wizard has proceeded, it is not possible to return to the EZ-Manager Welcome screen; however, if you simply wish to exit the wizard, you can do so by selecting the “EXIT” button from the subsequent screen(s).

From the EZ-Manager Welcome screen, you have the following options:

- To proceed with the EZ-Manager Wizard, use the arrow keys on the Installer Remote to select/highlight **NEXT** and press **OK**. Then, continue to the “TV Configuration Options” section on the following page.
- To exit the EZ-Manager Wizard, but retain the use of the Pro:Centric remote management feature on this TV (i.e., Installer Menu item 119 DATA CHANNEL set to 255) in the future, use the arrow keys on the Installer Remote to select/highlight **EXIT** and press **OK**. In the confirmation pop-up window, select **OK**, and then press **OK** once more on the Installer Remote.
- If you do not intend to install a Pro:Centric server on this system and you do not wish to use the EZ-Manager Wizard’s Zoning or USB configuration options, exit the wizard as follows: Use the arrow keys on the Installer Remote to select/highlight **NO PRO:CENTRIC** and press **OK**. This will disable the Pro:Centric feature of this TV (i.e., Installer Menu item 119 DATA CHANNEL will be set to 0) and exit the EZ-Manager Wizard. In the confirmation pop-up window, select **OK**, and then press **OK** once more on the Installer Remote.

TV Configuration Options

From the TV Configuration Options screen, you can choose how to proceed with the configuration of this TV (assuming you do not opt to exit the wizard, which you may also do at any time).



Note: If you intend to use the Zoning feature(s) on the TV for location-specific configuration purposes, select the “Zones & Room Number” option from this screen and assign the appropriate TV Zone # and/or the Wi-Fi Zone # in the TV BEFORE you continue with additional configuration.

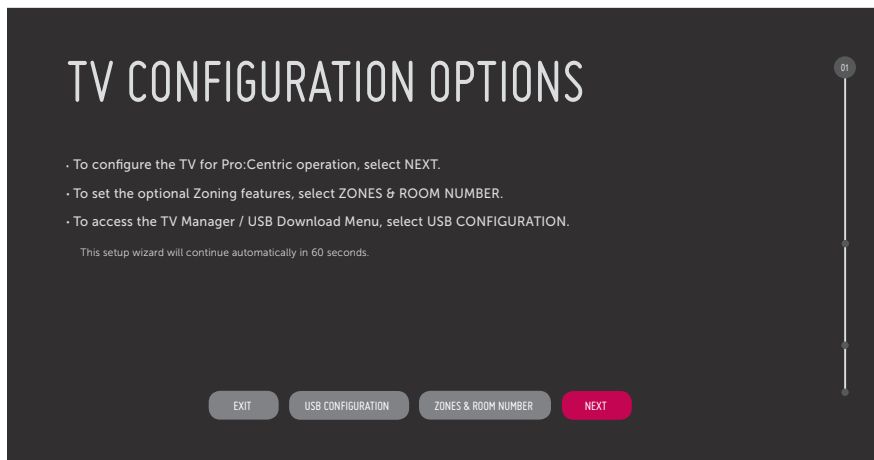

Note: If there is no user action in this screen within one minute, the wizard will automatically continue to the next configuration step.

Use the Left/Right arrow keys on the Installer Remote to navigate between options on this screen. Each time you select/highlight one of the following options, the screen text and fields will change in accordance with your selection.

- To continue with Pro:Centric configuration, select **NEXT** (default) and press **OK** on the Installer Remote. Refer to “Configure Pro:Centric Settings” on pages 17 to 21 for additional information.
- To set the Zoning feature(s) on the TV, select **ZONES & ROOM NUMBER**. See “Zones and Room Number Assignments” below for further information.
- Select **USB CONFIGURATION** to access the TV Manager / USB Download Menu. See “USB Configuration” on pages 21 to 22 for further information.

Note: If you choose to exit the EZ-Manager Wizard from this point on, you will have the option to save any settings made by selecting **SAVE & EXIT** in the exit confirmation pop-up window. Or, you can exit the wizard without saving any settings by simply selecting **OK** in the confirmation pop-up window.

Zones and Room Number Assignments

You may complete one or more of the fields in the Zones, Label, and Room Number screen or leave them at their default settings (TV Zone and Wi-Fi Zone) or blank (Label and Room Number), as desired. However, if you intend to use either of the Zoning features—TV Zoning and/or Wi-Fi Zoning—on this TV, you **MUST** specify the appropriate values in the TV Zone and/or Wi-Fi Zone fields as described on the following page. See also Reference section, “Using the TV’s Zoning Features,” for further information.

EZ-Manager Wizard (Cont.)

Note: Zoning features are only applicable for TVs that will be configured using a TLX file (local or remote configuration).

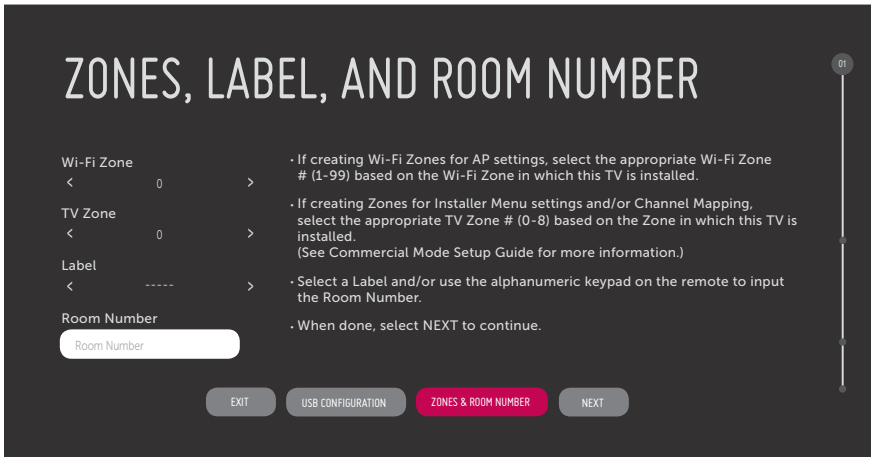

1. Complete the appropriate field(s) as described below. Use the Up/Down arrow keys on the Installer Remote to navigate between each of the fields.
 - **Wi-Fi Zone:** Enables you to set a Wi-Fi Zone # so that the TV can be configured with a particular access point's login data for wireless networking. Login data (i.e., SSID, security type, and security key) may be provided in a TLX file to be used for configuration.
To assign a Wi-Fi Zone, navigate to the Wi-Fi Zone field at the top left of the screen, and use the Left/Right arrow keys to specify the desired Wi-Fi Zone # (1–99).
 - **TV Zone:** Enables you to set a TV Zone # so that the TV can be configured with Installer Menu and/or TV Setup Menu settings intended only for the assigned Zone. The Installer Menu and/or TV Setup Menu settings may be provided in a TLX file to be used for configuration. If the TV is being configured for FTG Mode via CPU, the TV Zone # setting also allows the TV to omit channels that have been restricted in the FTG Channel Map.
To change the TV Zone from its default value (0), navigate to the TV Zone field, and use the Left/Right arrow keys to specify the desired TV Zone # (1–8).
 - **Label:** Allows you to select a North, South, East, or West text label for this TV. In the Label field, use the Left/Right arrow keys to select the applicable label.
 - **Room Number:** Allows you to specify the number of the room—up to 16 characters—in which the TV is located. To enter a room number, navigate to the Room Number field and press **OK**. You can then use the number keys on the Installer Remote to direct enter a room number, or you can use the arrow keys to select the appropriate alphanumeric character(s) from the pop-up virtual keyboard at the bottom of the screen. When you are done, select **Enter** from the virtual keyboard, and then press **OK** on the Installer Remote.
2. When you are ready to continue, select the appropriate option, as follows:
 - To proceed to the next EZ-Manager screen, use the arrow keys to select **NEXT**, and then press **OK** on the Installer Remote. Continue to the “Configure Pro:Centric Settings” section on the following page.
 - To use a USB memory device in conjunction with the TV Manager / USB Download Menu to complete the configuration, continue to “USB Configuration” on pages 21 to 22.

Configure Pro:Centric Settings

Once you select “NEXT” from the TV Configuration Options screen, the Searching for Pro:Centric Server screen is displayed.

Note: If any of the configuration steps fails, you will see a “Diagnostics” screen with an indication of the failure. You will then have the opportunity to reinitiate the configuration process from the previous screen or exit the EZ-Manager Wizard.

Note: Select the “BACK” button, where available, to check previous settings, as necessary.

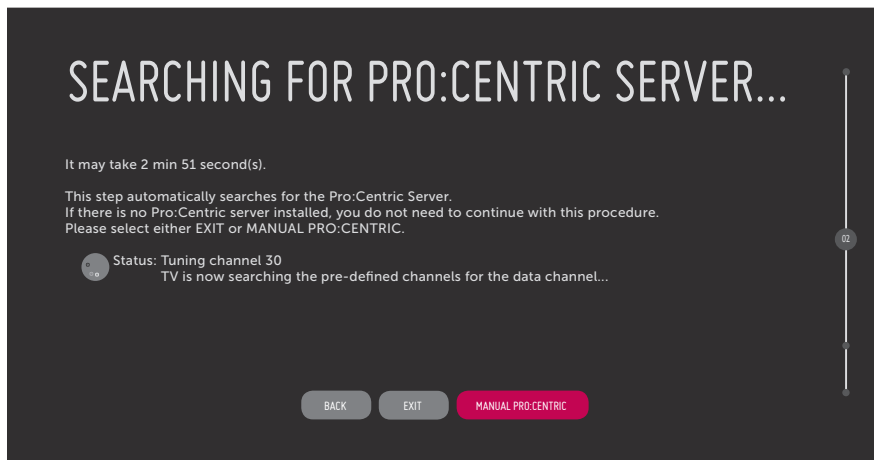

You have the following options:

- You can allow the EZ-Manager Wizard to proceed with a series of automated steps to configure the TV for Pro:Centric operation and then to look for the Pro:Centric application and maintenance (E-Z Installation) files to download. In this case, the wizard uses a search algorithm to determine the Data Channel and the Pro:Centric Application Mode to set in the TV.

Continue with the “Automated Pro:Centric Configuration” subsection below.

- If you already know the settings (i.e., Data Channel and Pro:Centric Application Mode) that need to be configured in order for the TV to connect to the Pro:Centric server and/or if the Pro:Centric server is not yet installed, you may expedite the setup process by entering this data manually.

Continue with the “Manual Pro:Centric Configuration” subsection on page 19.

Automated Pro:Centric Configuration

Note: If the server is not yet configured on the system, use the manual configuration option to configure the Pro:Centric operation. See also note below.

Note: If Pro:Centric data delivery will be over IP and there is a DNS server at the site, you can create a DNS entry “procentric.local” for the Pro:Centric server that will enable automated Pro:Centric IP configuration via the EZ-Manager. If there is no DNS entry for procentric.local, you must use the manual configuration option to configure the Pro:Centric IP operation.

Once the Pro:Centric data channel is found (a Pro:Centric Server Was Found screen will be displayed) and the Pro:Centric Application Mode is determined, the wizard will advance to the Processing the Pro:Centric Configuration screen, which shows the progress of the data downloads (see example on following page). Note that some steps may require a few minutes.

EZ-Manager Wizard (Cont.)

(Continued from previous page)

If the process is successful, no further user interaction is required, though, in some instances, where the option (for example “NEXT”) is available, you may manually move forward to subsequent steps within the wizard to speed up the process.

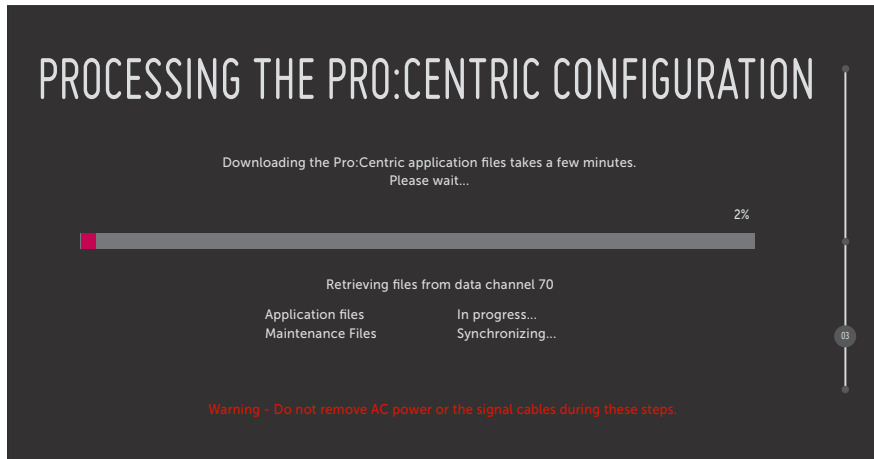

Note: If, after completing the search, the TV is unable to find the Pro:Centric data channel (while the Searching for Pro:Centric Server screen is on display), the wizard will stop and show a Diagnostics screen that enables you to manually return to the previous screen (to reinitiate the configuration) or exit the wizard.

When the Pro:Centric Configuration is complete, an EZ-Manager Configuration Complete screen is displayed (see example below), and after 10 seconds, the wizard exits, and the TV turns OFF.

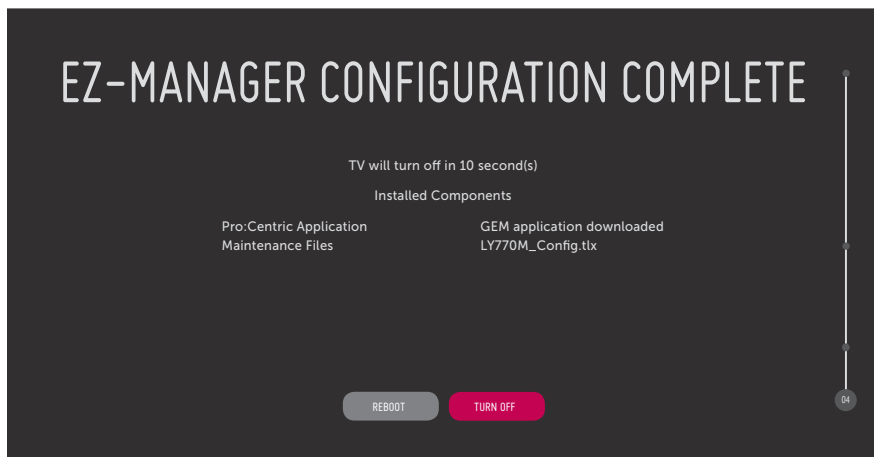

Note: With the EZ-Manager Configuration Complete screen on display, you can also manually turn off or reboot the TV. If desired, select **TURN OFF** or **REBOOT**, respectively, and then press **OK** on the Installer Remote.

Manual Pro:Centric Configuration

1. With the Searching for Pro:Centric Server screen on display, use the arrow keys on the Installer Remote to select/highlight **MANUAL PRO:CENTRIC** at the bottom right of the screen, and then press **OK**.

In the Pro:Centric Manual Configuration screen (see examples below), you will be able to configure the appropriate Pro:Centric settings in the TV. Use the Up/Down arrow keys on the Installer Remote to navigate between fields.

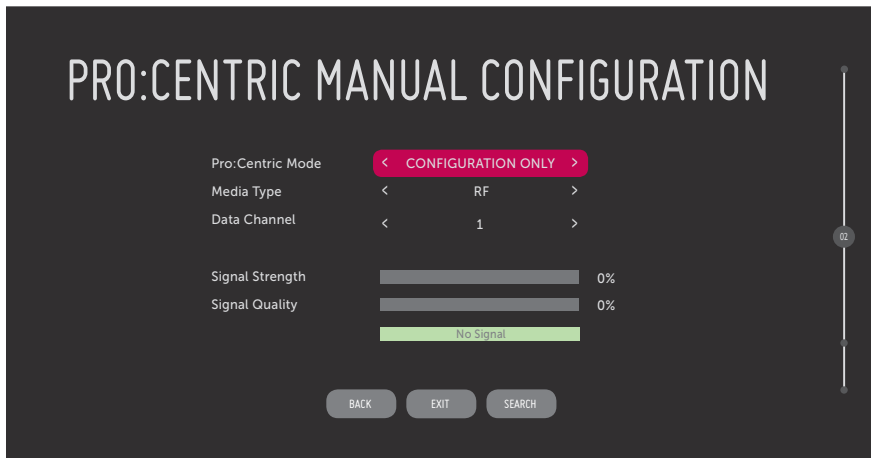

Pro:Centric Manual Configuration Screen with RF Media Fields

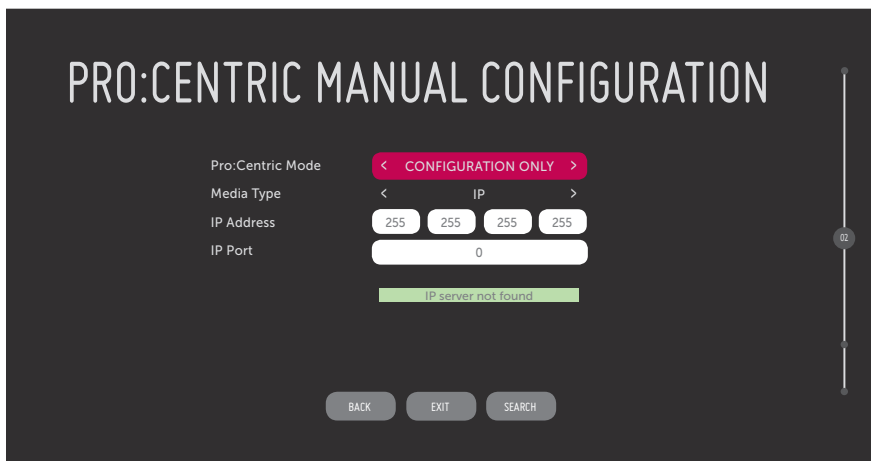

Pro:Centric Manual Configuration Screen with IP Media Fields

2. In the Pro:Centric Mode field, use the Left/Right arrow keys to select the appropriate Pro:Centric Application Mode—FLASH, GEM, HTML, or CONFIGURATION ONLY.

Note: For remote management only, select **CONFIGURATION ONLY**. The TV will search for TV E-Z Installation data downloads; however, Pro:Centric application data will not be downloaded, i.e., Installer Menu item 098 PRO:CENTRIC will be set to 0.

(Continued on next page)

EZ-Manager Wizard (Cont.)

(Continued from previous page)

3. Refer to the appropriate subsection below, depending on the Pro:Centric server configuration, to complete the remaining fields.

RF Configuration

- a) In the Media Type field, use the Left/Right arrow keys to select **RF**.
- b) In the Data Channel field, use the Left/Right arrow keys to select the RF channel number that will be used by the Pro:Centric server as its data channel. The Data Channel value can be set from 1 to 135.*

IP Configuration

- a) In the Media Type field, use the Left/Right arrow keys to select **IP**.

Note: By default, the Pro:Centric Manual Configuration screen initially shows RF configuration fields. When you select "IP" as the Media Type, the Data Channel and Signal Strength/Quality fields are replaced with IP Address and IP Port fields.

- b) Enter the Pro:Centric server IP address and port number in the IP Address and IP Port fields, respectively. The IP address must match the IPv4 multicast address and the port number must match the port number that is set in the Pro:Centric server.

For each data entry field: Use the arrow keys to select the field and press **OK**. Then, you can either use the number keys on the Installer Remote to direct enter data values or use the arrow keys to select the appropriate number(s) from the pop-up virtual keyboard displayed at the bottom of the screen. When you are done, select **Enter** from the virtual keyboard, and then press **OK** on the Installer Remote.

4. Once all fields are completed as required, you have two options (see also note below):
 - To save the data entered and exit the wizard, use the arrow keys to select **EXIT** and then press **OK**. In the subsequent pop-up confirmation window, select **SAVE & EXIT**, and then press **OK** once more. The Pro:Centric application and/or E-Z Installation data will be downloaded to the TV at a later time. This option is useful, in particular, if the Pro:Centric server has not yet been configured.
 - To initiate a real-time download of Pro:Centric application and/or E-Z Installation data, use the arrow keys to select **NEXT**, and then press **OK**.

The EZ-Manager Wizard will proceed with the remaining Pro:Centric application and/or E-Z Installation data download steps (see Processing the Pro:Centric Configuration screen example on page 18).

Note: With RF configuration, Pro:Centric server data must be present on the RF channel selected as the TV's Data Channel in order for you to select "NEXT" (you will see a "data channel found" message below the Signal Quality indicator). With IP configuration, Pro:Centric server data must be present via the wired LAN cable connection in order for you to select "NEXT" (you will see a "IP server found" message below the IP Port field). The "NEXT" button is initially a "SEARCH" button until the data entered is verified.

(Continued on next page)

* PCS150R and later Pro:Centric servers do not support HRC or IRC cable channel frequencies.

(Continued from previous page)

When the Pro:Centric configuration is complete, an EZ-Manager Configuration Complete screen (see example on page 18) is displayed, and after 10 seconds, the wizard exits, and the TV turns OFF.

Note: With the EZ-Manager Configuration Complete screen on display, you can also manually turn off or reboot the TV. If desired, select **TURN OFF** or **REBOOT**, respectively, and then press **OK** on the Installer Remote.

USB Configuration

The TV Manager / USB Download Menu provides options that enable you to download individual configuration or software files to the TV, or you can use the Ez Download utility available from the menu to select and download multiple configuration or software files at one time.

Each of the TV Manager / USB Download Menu functions requires that you have the appropriate file(s) loaded on a USB memory device. If you wish to perform a software update or download a splash screen image from the TV Manager / USB Download Menu, the software update/image file(s) must be stored in a folder named "LG_DTV" in the root directory of the USB memory device. TLX files should simply be stored in the root directory of the USB device.

The procedure below assumes the desired file(s) is/are already loaded onto the USB device. For further information on TV Manager / USB Download Menu functions and file requirements, and/or for information on creating TLX files, refer to the appropriate section(s) in this document.

Before You Begin

- If you intend to use the Zoning feature(s) on this TV, make sure to assign the appropriate TV Zone # and/or Wi-Fi Zone # in the EZ-Manager's Zones, Label, and Room Number screen BEFORE continuing with USB Configuration. See "TV Configuration Options" on page 15 for further information.
- Ensure the USB device to be used has been formatted with FAT format.
- Refer to "Ez Download Utility" on pages 31 to 34 for further information on the Ez Download utility.
- Refer to "Custom Master TV Setup" on pages 46 to 48 for information on creating a TLX file for cloning purposes, and/or refer to "Creating an FTG Configuration File" on pages 59 to 60 for information on creating a FTG Configuration (.tlx) file for FTG Mode via CPU configuration.
- See Reference section, "Downloading a Splash Screen Image using a USB Memory Device," for splash screen image guidelines.
- See Reference section, "Updating TV/PTC Software using a USB Memory Device," for further information on software updates.

USB Configuration via EZ-Manager Wizard

With either the TV Configuration Options or the Zones, Label, and Room Number screen on display, proceed as follows to configure the TV using the USB memory device.

1. Insert the USB memory device that contains the appropriate file(s) into either of the TV's USB ports.

(Continued on next page)

EZ-Manager Wizard (Cont.)

(Continued from previous page)

2. Use the arrow keys on the Installer Remote to select **USB CONFIGURATION**, and then press **OK**.

You will be redirected to the TV's TV Manager / USB Download Menu (see example below).

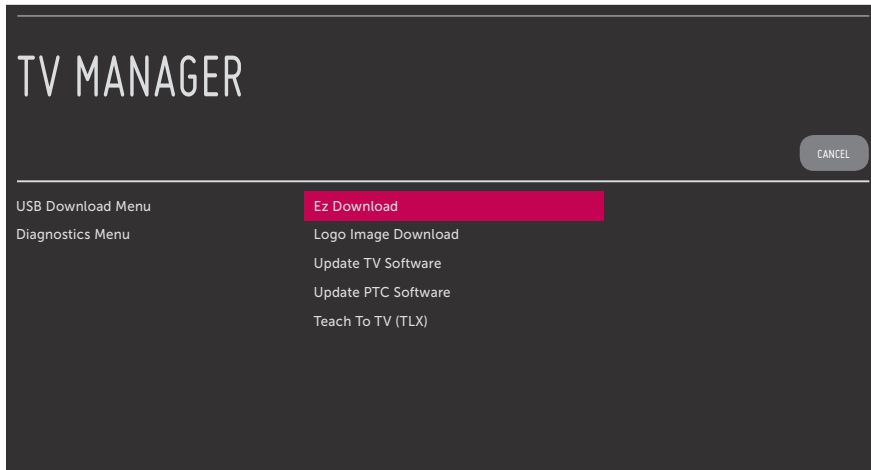

Note: You can select **CANCEL** and press **OK** on the Installer Remote at any time to return to the EZ-Manager Wizard.

3. Select the appropriate option from the TV Manager / USB Download Menu, and complete the download(s) as required.

Note: If you perform a software update, the TV will complete the update and then reboot. Upon restart, the TV will display the EZ-Manager TV Configuration Options screen. If desired, you can re-access the TV Manager / USB Download Menu (to perform additional functions), proceed with configuration via the wizard, or exit the wizard.

4. Remove the USB memory device, and verify that the appropriate configuration/update(s) is/are resident on the TV.

Initiate the Express Script

Note: While the Express Script enables you to set up TVs in lieu of cloning, you can also use an Express Script TV Setup for cloning purposes (clone programmer only), if desired. However, note that TV setup menu customization via the Express Script is limited to Channels Menu options.

After you select the “Express Script” option from the Setup Wizard Welcome screen, an Express Script Welcome screen provides a brief introduction to the Express Script.

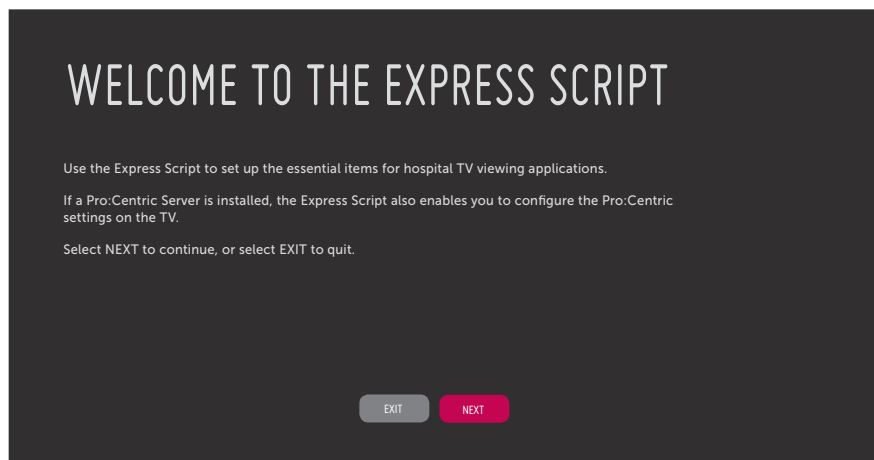

From the Express Script Welcome screen, you have the following options:

- To proceed with the Express Script, use the Left/Right arrow keys on the Installer Remote to select/highlight **NEXT**. Then, press **OK** on the Installer Remote.
Note: Select this option even if you only intend to configure the Pro:Centric settings on this TV. After you configure the Pro:Centric settings, you will have the option to exit without completing the remainder of the wizard, if desired.
- To exit the Express Script without completing any configuration, use the Left/Right arrow keys on the Installer Remote to select/highlight **EXIT** and press **OK**. In the confirmation pop-up window, select **OK**, and then press **OK** once more on the Installer Remote.

Configure Pro:Centric Settings

The next screen enables you to set up the Pro:Centric feature of the TV (see screen examples on following page). By default, the Data Channel is configured for Auto Search, which enables the TV's Data Channel Auto Search feature to set the Data Channel value. See item 119 DATA CHANNEL description on page 44 for further information on the Data Channel Auto Search feature. The Pro:Centric Application Mode default setting is “Configuration Only,” which enables remote management only. That is, the TV will search for TV E-Z Installation data downloads; however, Pro:Centric application data will not be downloaded, i.e., Installer Menu item 098 PRO:CENTRIC will be set to 0.

Express Script (Cont.)

If you wish to proceed with the wizard without changing the default values for the Pro:Centric settings, you can simply select **NEXT** and press **OK** on the Installer Remote. Or, if you wish to exit the wizard while retaining the default values for Pro:Centric settings, use the arrow keys on the Installer Remote to select **DONE**, and then press **OK**.

If you already know the Pro:Centric settings that need to be configured in order for the TV to connect to the Pro:Centric server and/or if the Pro:Centric server is not yet installed, use the procedure on the following page to expedite the setup process. Use the Up/Down arrow keys on the Installer Remote to navigate between the fields.

Note: If you wish to disable the Pro:Centric feature of the TV, select the Data Channel field, and then use the Left/Right arrow keys on the Installer Remote to select **DISABLED**. From here, you may opt to proceed with the wizard (select **NEXT**) or save this setting and exit the wizard (select **DONE**). See also step 3 below.

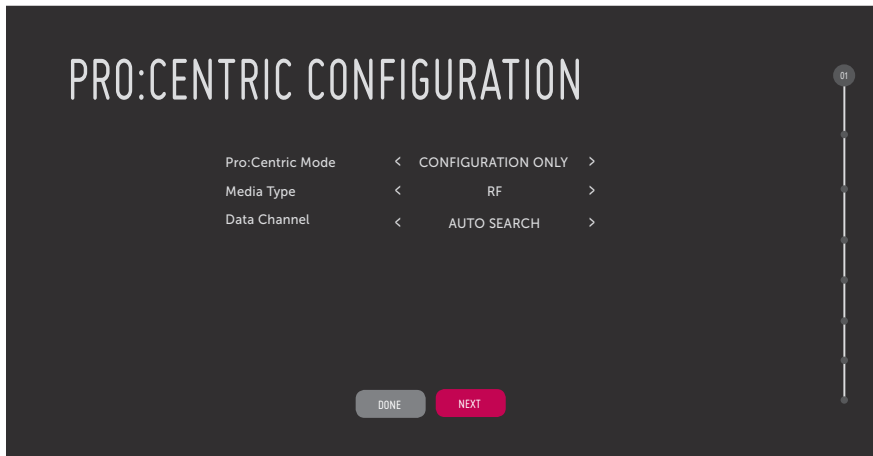

Pro:Centric Configuration Screen with RF Media Fields

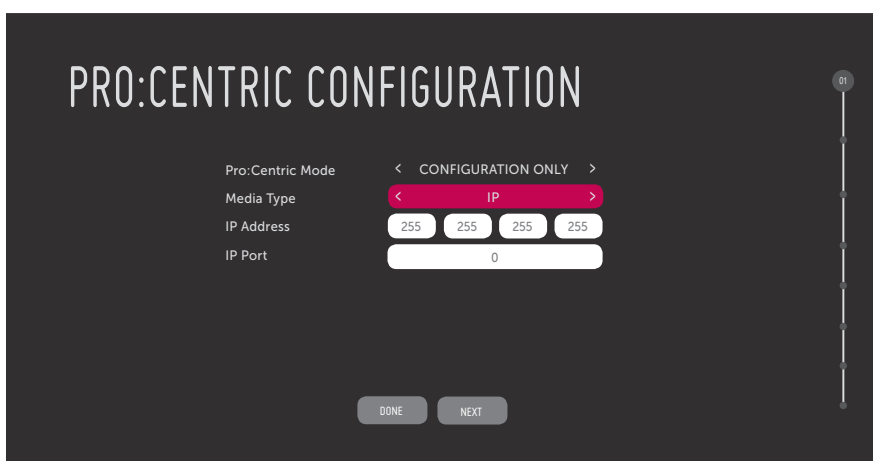

Pro:Centric Configuration Screen with IP Media Fields

(Continued on next page)

(Continued from previous page)

1. In the Pro:Centric Mode field, use the Left/Right arrow keys on the Installer Remote to select the appropriate Pro:Centric Application Mode—FLASH, GEM, HTML, or CONFIGURATION ONLY.

Note: For remote management only, select **CONFIGURATION ONLY**. The TV will search for TV E-Z Installation data downloads; however, Pro:Centric application data will not be downloaded, i.e., Installer Menu item 098 PRO:CENTRIC will be set to 0.

2. Refer to the appropriate subsection below, depending on the Pro:Centric server configuration, to complete the remaining fields.

RF Configuration

- a) In the Media Type field, use the Left/Right arrow keys on the Installer Remote to select **RF**.
- b) In the Data Channel field, use the Left/Right arrow keys to select the RF channel number that will be used by the Pro:Centric server as its data channel. The Data Channel value can be set from 1 to 135. *

IP Configuration

- a) In the Media Type field, use the Left/Right arrow keys on the Installer Remote to select **IP**.
Note: By default, the Pro:Centric Configuration screen initially shows RF configuration fields. When you select “IP” as the Media Type, the Data Channel field is replaced with IP Address and IP Port fields.
- b) Enter the Pro:Centric server IP address and port number in the IP Address and IP Port fields, respectively. The IP address must match the IPv4 multicast address and the port number must match the port number that is set in the Pro:Centric server.

For each data entry field: Use the arrow keys to select the field and press **OK**. Then, you can either use the number keys on the Installer Remote to direct enter data values or use the arrow keys to select the appropriate number(s) from the pop-up virtual keyboard displayed at the bottom of the screen. When you are done, select **Enter** from the virtual keyboard, and then press **OK** on the Installer Remote.

3. Once all fields are completed as required, you have two options:
 - To proceed with TV configuration via the Express Script, select **NEXT** and press **OK** on the Installer Remote. See also “Complete the TV Configuration” on the following page.
 - To save the data entered and exit the Express Script, use the arrow keys to select **DONE** and then press **OK** on the Installer Remote. Remember, however, that if you do not complete the Express Script, pillow speaker functionality will not be enabled unless you set Installer Menu item 027 HOSPITAL MODE appropriately. See the “Installer Menu” section of this document for further information.



Note: If you intend to use a TLX file for cloning or FTG Mode via CPU configuration purposes, exit the Express Script at this time.

* PCS150R and later Pro:Centric servers do not support HRC or IRC cable channel frequencies.

Express Script (Cont.)

Complete the TV Configuration

The following procedure describes the remaining steps in the Express Script. You can select the “BACK” button, where available, to check previous settings, as necessary.

 **Note: If you choose to exit the Express Script from this point on, any settings made will not be retained.**

Note: Typically, if you do not modify the default settings, the “NEXT” button is automatically selected when you proceed forward within the Express Script. Where appropriate, you can simply press **OK** on the Installer Remote to proceed to the next step if the default value(s) for the TV parameter(s) in question are applicable for your installation.

1. In the Select the Tuning Band screen, use the Up/Down arrow keys on the Installer Remote to highlight/select the appropriate tuning band option: Cable Standard (default), Cable HRC, Cable IRC, or Air. Then, press **OK**. When you have made your selection, use the arrow keys to select **NEXT**, and then press **OK**.

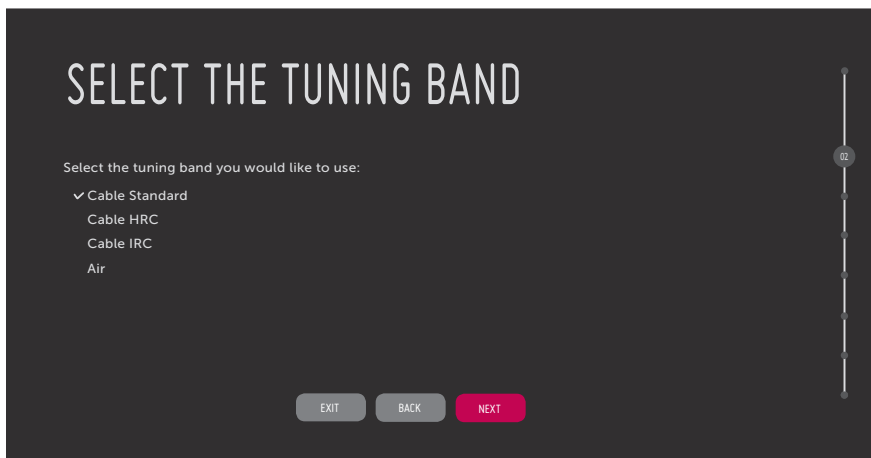

2. By default, all Aux inputs are enabled, as shown initially in the Enable/Disable Aux Inputs screen. To disable an Aux input, use the arrow keys on the Installer Remote to select the desired input, and then use the Left/Right arrow keys to toggle the status value to **DISABLED**.

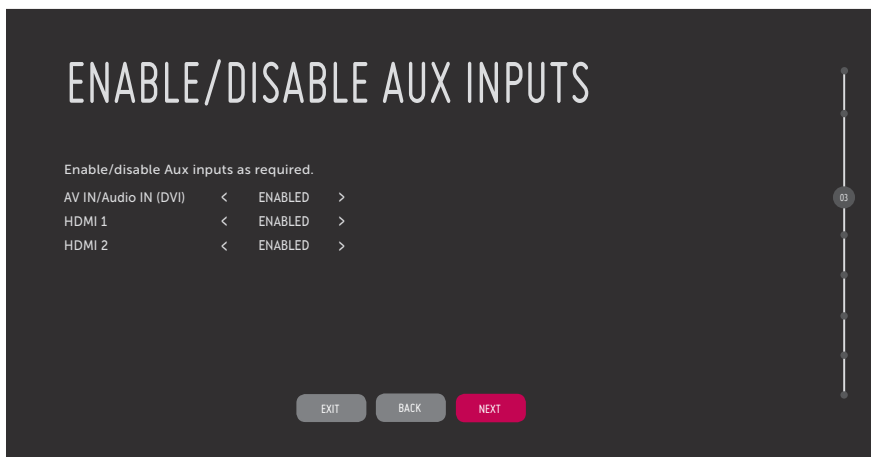

(Continued on next page)

(Continued from previous page)

Note: If an Aux input will not be used, it is advisable to disable it. After the TV setup is transferred to the PTC (see step 7), the only way to remove Aux inputs from the PTC Channel Map, is to go to the Channel Preview/Banks Setup Menu and select Normal-Deleted.

- Use the arrow keys on the Installer Remote to select the appropriate speaker configuration:
 - Highlight/select the desired speaker—Pillow Only (default), TV Only, or Pillow & TV. Then, press **OK**.
 - If applicable, select the pillow speaker code/voltage and press **OK**.

Note: If using a Pro:Centric pillow speaker (LG IR codes) or a pillow speaker with Zenith IR codes, make sure the “Zenith” pillow speaker code (default) is selected.

When you have made your selection(s), use the arrow keys to select **NEXT**, and then press **OK**.

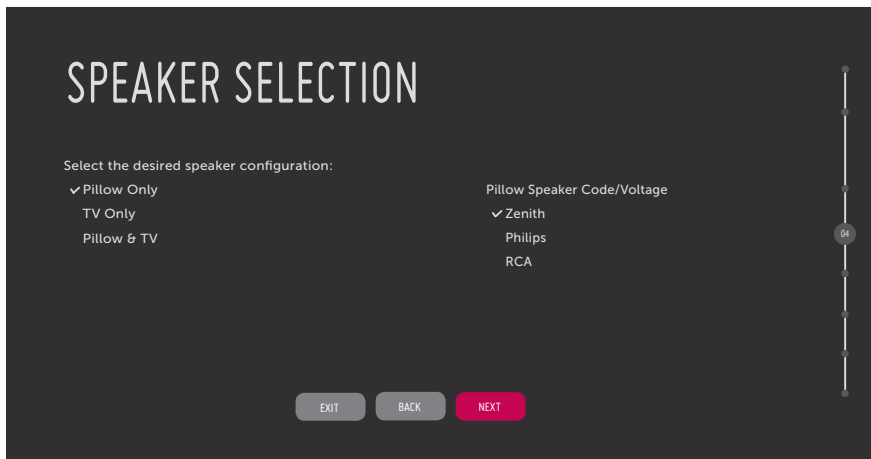

- In the Channel Tuning screen, you have the option to initiate an automated channel scan that will search for all available analog and digital channels. Select **RUN AUTO TUNING** and press **OK** on the Installer Remote to start the channel scan.

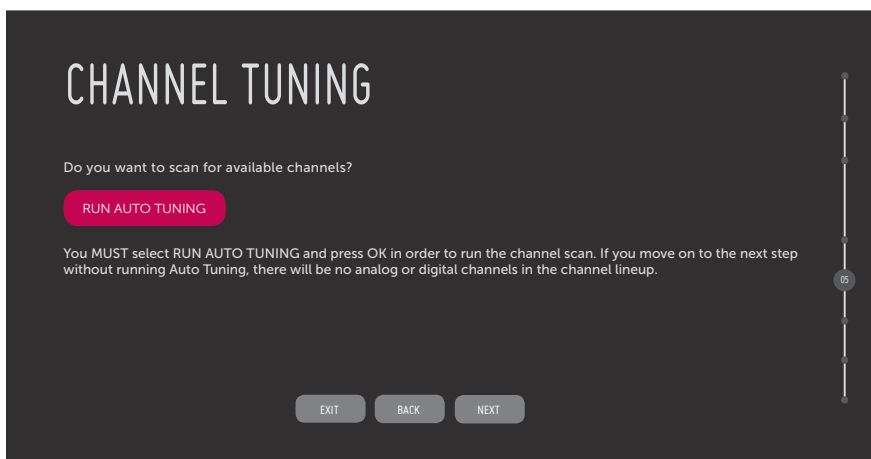

(Continued on next page)

Express Script (Cont.)

(Continued from previous page)



Note: You **MUST** select **RUN AUTO TUNING** and press **OK** in order to run the channel scan. If you move on to the next step without running Auto Tuning, there will be no analog or digital channels in the channel lineup. In this case, upon completion of the Express Script, the only channels in the resulting PTC Channel Map will be any enabled Aux inputs.

Auto Tuning progress will be shown in a new Channel Tuning screen. The scan typically takes a few minutes. When the channel scan is complete, the Express Script will automatically advance to the Edit the Channel Lineup screen. Continue with step 5.

Note: If you do not want to run Auto Tuning, use the arrow keys on the Installer Remote to select **NEXT** and press **OK**.

5. In the Edit the Channel Lineup screen, you can customize the channel lineup, add channel labels and icons, etc. before the channel lineup is transferred to the commercial controller (PTC) in step 7. You can also set up channel banks in this screen.

Note: The total number of channels found (“Searched”) during Auto Tuning is indicated at the top left of the display.

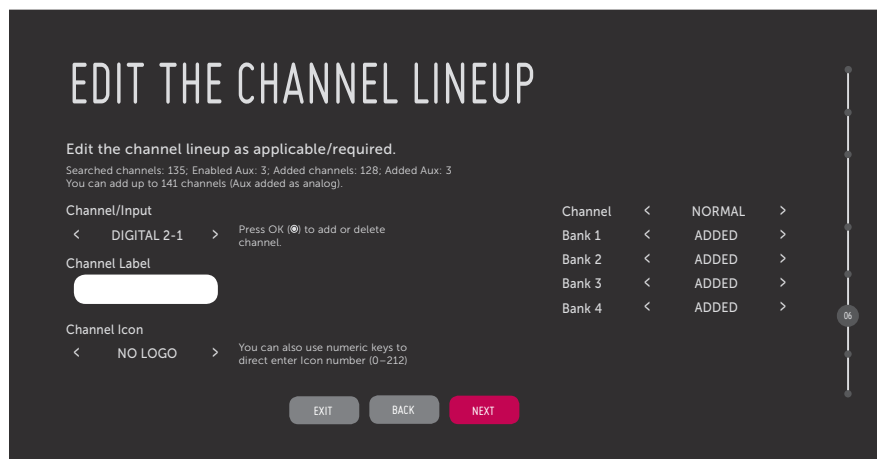

Note: The maximum number of channels (analog, digital, and Aux inputs) that can be transferred to the PTC is 141. An attempt to transfer more than 141 channels of any combination will result in a PTC Channel Map of exactly 141 channels; any extra channels will not be available in the PTC Channel Map. For example, if you enabled three Aux inputs in step 2 and Auto Tuning found 141 channels, you must edit the Channel Map to decrease the number of analog/digital channels to (at most) 138 in order to accommodate the Aux inputs in the PTC Channel Map. Note that Aux inputs will appear between the highest analog and lowest digital channel number in the PTC Channel Map.



Note: If, for any reason, you elect to re-run Auto Tuning after customizing channels in this screen, your current custom channel settings will be lost, and you will need to replicate the desired customization.

(Continued on next page)

(Continued from previous page)

Use the arrow keys to navigate between the fields in this screen:

- Channel/Input: Edit the channel lineup, as necessary, to include only clear (non-encrypted) channels. Use the Left/Right arrow keys on the Installer Remote to select channels, and press **OK** to delete (or re-add) channels per your system requirements.
Note: When a channel is active in the channel lineup (i.e., added), all additional fields in this screen are selectable/available. If a channel is deleted, all other fields in this screen become inaccessible (grayed out).
- Channel Label: Press **OK** to display the pop-up virtual keyboard, and add a custom text label for each channel (up to seven characters) or Aux input (up to 10 characters), as desired.
- Channel Icon: This field enables you to select the appropriate trademark/icon for each channel's Channel-Time on-screen display. If known, you can direct enter the icon number using the number keys on the Installer Remote. Otherwise, use the arrow keys on the Installer Remote to select/highlight either the left (<) or right (>) arrow in the Channel Icon field, and press **OK** until the desired logo is shown. Icons are available for familiar channels, such as ABC, CBS, NBC, etc. Identifiable icons should enable the end user to readily know what common networks are available.
- Channel Banks: Use the arrow keys to define channel banks, as desired. See pages 49 to 52 for further information on channel banks.

When you are finished, use the arrow keys to select **NEXT**, and then press **OK**.

6. In the next screen, choose whether to allow access to channels outside the channel lineup.
 - To allow direct access to channels outside the channel lineup (default: YES), you can simply select **NEXT** and press **OK** on the Installer Remote.
 - To limit access to only the channel lineup (after the Express Script is complete) and restrict access to the Channels Menu in the TV setup menus, use the arrow keys on the Installer Remote to highlight/select the channel access field, and toggle the value to **NO**. When you have made your selection, use the arrow keys to select **NEXT**, and then press **OK**.

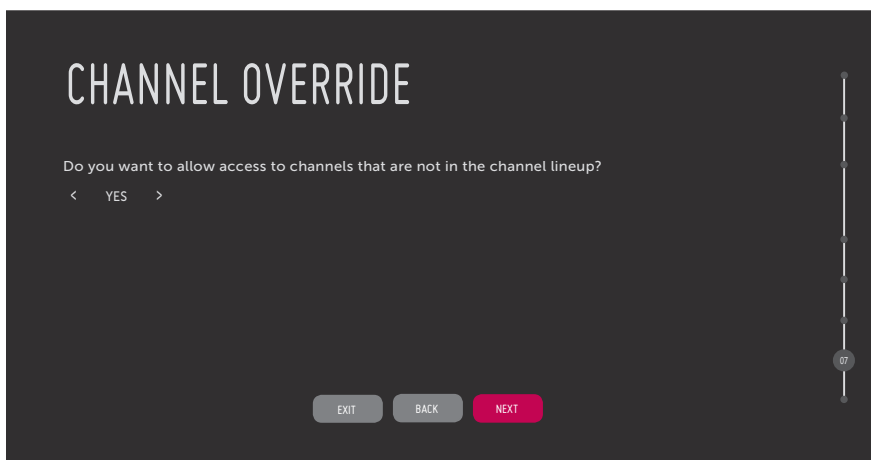

(Continued on next page)

Express Script (Cont.)

(Continued from previous page)

Note: It is recommended that you select “NO” to limit access to the channel lineup and prevent end users from accessing channel settings; i.e., the Channels options in the TV setup menus will be inaccessible/grayed out.

7. As the final step of the Express Script, the TV saves your settings and transfers the auto-tuned/edited channel lineup to the commercial controller (PTC). When you are ready to proceed, select **FINISH**, and then press **OK**.

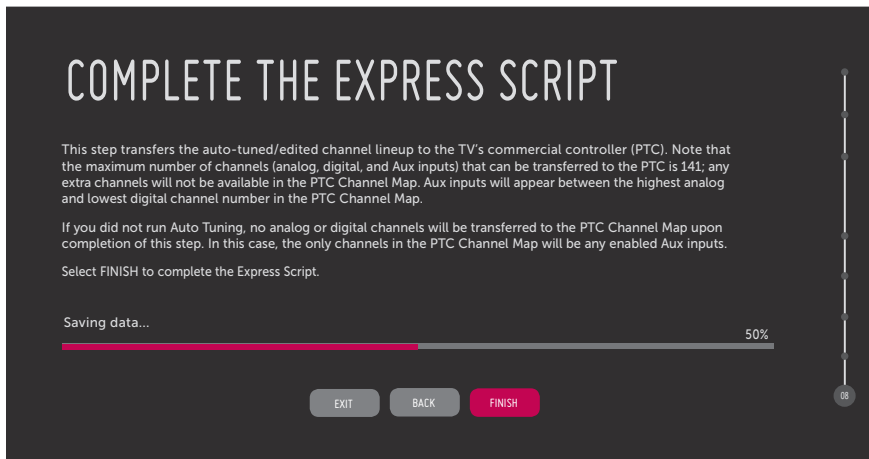

Configuration progress will be shown at the bottom of the screen. When this step is complete, the Express Script exits, and the TV tunes to the first channel in the PTC Channel Map.

Note: If desired, you can clone the TV Setup created from the Express Script using a legacy LT2002 or TLL-1100A clone programmer.

Note: If access to the channel lineup has been limited at the completion of the Express Script (see step 6) and you would like to set up channel banks at a later time, you will need to set Installer Menu item 028 CH. OVERRIDE to 1 to enable access to the Channel Preview/Banks Setup Menu. See pages 49 to 52 for further information on channel banks.

The Ez Download utility, available from the TV Manager / USB Download Menu, enables you to select multiple files at one time from the files loaded on a USB memory device. You may use this utility to download any one or all of the following to a TV: a TLX file for configuration purposes, a TV CPU or PTC software update, a splash screen image.

Before You Begin

- Ensure the USB device has been formatted with FAT format.
- Software update and splash screen image files must be stored in a folder named “LG_DTV” in the root directory of the USB memory device. TLX files should simply be stored in the root directory of the USB device.
- If you have initiated the EZ-Manager Wizard, you can use the wizard’s “USB Configuration” option to access the Ez Download utility, if desired (see “TV Configuration Options” and/or “USB Configuration” on pages 15 and 21, respectively, as necessary).
- If the TV is currently in Pass-through Mode and you intend to use the Zoning feature(s) on this TV for location-specific configuration purposes, make sure to assign the appropriate TV Zone # and/or Wi-Fi Zone # in the TV when directed to do so in the procedure below.
- Refer to “Custom Master TV Setup” on pages 46 to 48 for information on creating a TLX file for cloning purposes, and/or refer to “Creating an FTG Configuration File” on pages 59 to 60 for information on creating an FTG Configuration (.tlx) file for FTG Mode via CPU configuration.
- See Reference section, “Downloading a Splash Screen Image using a USB Memory Device,” for splash screen image guidelines.
- See Reference section, “Updating TV/PTC Software using a USB Memory Device,” for further information on software updates.



Caution: Do not unplug the TV power cord or remove the USB memory device during a data download, as doing so may cause the TV to malfunction or harm the USB device, respectively.

Accessing and Using the Ez Download Utility

1. If it is not ON already, turn ON the TV.
2. The next step depends on whether the LG Setup Wizard appears on the screen when you turn ON the TV:
 - If the wizard is displayed, you can access the Ez Download utility via the EZ-Manager Wizard, as indicated above (see “Before You Begin”). However, to continue with this procedure and access the Ez Download utility from the TV menus, exit the Setup Wizard. Then, continue with step 3.
 - If the wizard is not displayed, go directly to step 3.

(Continued on next page)

Ez Download Utility (Cont.)

(Continued from previous page)

3. If the TV is currently in Pass-through Mode, you would like to transfer (Teach) a TLX file to the TV via the Ez Download utility, and you intend to use one or both of the TV's Zoning feature(s), assign the appropriate TV Zone # and/or Wi-Fi Zone # in the TV at this time. See Reference section, "Using the TV's Zoning Features," for further information.



Note: In order for the proper location-specific TV Zone and/or Wi-Fi Zone profile data to be applied, the Zone designation(s) must be assigned in the Target TV(s) BEFORE you continue with the Ez Download utility.

4. Insert the USB memory device that contains the appropriate file(s) into either of the TV's USB ports.
5. To access the TV Manager / USB Download Menu from the TV menus:
 - Press **MENU** on the Installer Remote to display the TV setup menus (TV is in Pass-through Mode) or the Function Menu (TV is not in Pass-through Mode).
 - Use the arrow navigation keys to select/highlight either the **General** menu icon from the TV setup menus or the **Safety** menu icon from the Function Menu. Then, press the number "7" key a total of seven times to display the TV Manager / USB Download Menu.

Note: The TV Manager / Diagnostics Menu is for service use only.

6. With the TV Manager / USB Download Menu on display, use the Up/Down arrow keys to select **Ez Download**, and then press **OK**.

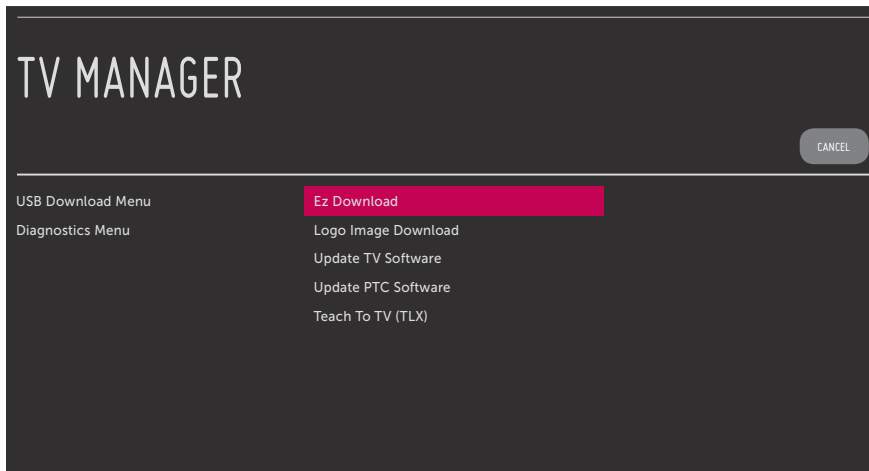

The Ez Download utility screen contains a listing of the Logo (i.e., Splash Screen) Image, TV Software (CPU), and PTC Software files stored in the LG_DTV folder and the TLX files stored in the root directory on the USB device.

(Continued on next page)

(Continued from previous page)

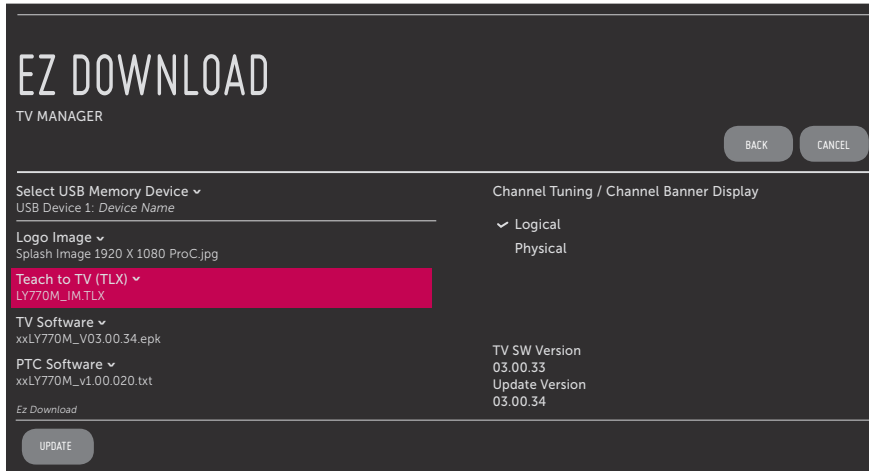

Note: If there are no files of a particular file type on the USB device, that file type field will not be displayed in the Ez Download screen. For example, if there are no PTC files on the USB device, you will not see a “PTC Software” field in the Ez Download screen.

Note: Press **↵** on the Installer Remote or select **BACK**, as necessary, to return to the TV Manager / USB Download Menu. To exit the TV Manager, select **CANCEL** (if accessed from the TV menus, you may also press **EXIT** on the Installer Remote to exit). If you accessed the TV Manager via the EZ-Manager Wizard, you will be returned to the last screen on display before you selected the “USB Configuration” option. If you accessed the TV Manager via the TV menus, you will be returned to program viewing.

7. If more than one USB memory device is currently connected to the TV, be sure to select the USB device that contains the file(s) you wish to use. If necessary, use the Up/Down arrow keys on the Installer Remote to select/highlight the **Select USB Memory Device** field and press **OK**. Then, use the arrow keys to select the appropriate USB device from the drop-down list.
8. To select a file use the Up/Down arrows on the Installer Remote to select/highlight the appropriate file type/pull-down field, and then press **OK** to view a drop-down list of available options. From the drop-down list, use the Up/Down arrow keys to select the desired file.

Note: The utility will only allow you to select one of each file type for downloading. For example, if there are two files in the Ez Download Teach To TV (TLX) list, you can only select one or the other of those two files.

Note: The initial default value for each file type is “None.” After the Ez Download utility is run, a file is automatically created and stored on the USB device that was used. The file, which will have a “.dzm” file extension, maintains a history of the file(s) previously used with the Ez Download. The next time(s) you use this USB device with the Ez Download utility, the file(s) selected for the last download will be pre-selected for the current download.

Note: If a TV Software (CPU) file is selected, TV SW Version and Update Version fields will be displayed at the bottom right of the screen. Ensure the software version of the selected file is the correct version before applying the update to this TV.

(Continued on next page)

Ez Download Utility (Cont.)

(Continued from previous page)

9. If a TLX file that includes an FTG Channel Map is selected, a Channel Tuning / Channel Banner Display field will be displayed at the right of the screen. If the FTG Channel Map comprises RF channels and Aux inputs *only* (the latter designated by 130-0 through 137-0), you can choose the format for the channel tuning/banner display. Use the arrow keys on the Installer Remote to select **Logical** tuning or **Physical** tuning. A checkmark will appear at the left of the selected option. Logical tuning is selected by default.

Note: If an FTG Channel Map includes IP channels, only logical tuning is available. Also, if the selected TLX file does not include an FTG Channel Map, the message, "No Channel Map in TLX file," will be displayed at the right of the screen.

10. When you are ready to continue, use the arrow keys on the Installer Remote to select **UPDATE**, and then press **OK**.

Update progress will be shown in a new screen. Do NOT remove the USB device while updates are in progress. When the Ez Download utility process is complete, the TV will briefly display an overview of the results and then either return to program viewing or reboot (the latter if software has just been updated).

11. Remove the USB memory device, and verify that the appropriate configuration/update(s) is/are resident on the TV.

Note: (TLX configuration only) When configuration is complete, the TV tunes according to the Start Channel setting in the Installer Menu. If a Start Channel is specified, the TV will tune to that channel, though in the case of FTG Mode via CPU configuration, a channel banner will only be displayed if the Start Channel is included in the FTG Channel Map (depending on your selection in step 9, the channel banner will display either the Start Channel's logical channel number or physical RF channel number). Otherwise, the TV will either return to the last channel tuned (TV in Pass-through Mode) or tune to the first channel in the FTG Channel Map (TV in FTG Mode via CPU). In the latter case, remember that the channels in the FTG Channel Map are always arranged in logical order, regardless of your selection in step 9.

Use the Installer Menu to set up, change, or view operational settings. This section describes how to access, use, and exit the Installer Menu from the TV itself. However, you should also refer to the Installer Menu descriptions in this document if you are configuring the TV CPU using a TLX file created using LG's FTG File Manager software or configuring the EBL locally (.rml) or remotely (via FMA-LG101 / .fma) using the FTG Device Configuration Application software.

Refer to the table on pages 37 and 38 for brief descriptions of Installer Menu items. More detailed descriptions follow the table listing.

Accessing the Installer Menu

1. Turn ON the TV.

If the LG Setup Wizard appears on the screen when you turn ON the TV, exit the wizard.

2. Using an Installer Remote, press **MENU** repeatedly until the on-screen display of the TV setup menus (if the TV is in Pass-through Mode) or the Function Menu (if the TV is not in Pass-through Mode) no longer toggles, and then press the Installer Menu entry sequence (e.g., **9-8-7-6**) + **OK** to access the Installer Menu.

Note: The default Installer Menu entry sequence is "9876"; however, if Installer Menu item 000 INSTALLER SEQUENCE has been modified, the entry sequence may be one of three additional options. See Installer Menu detailed descriptions for further information.

The Installer Menu opens with item 000 INSTALLER SEQ 000.

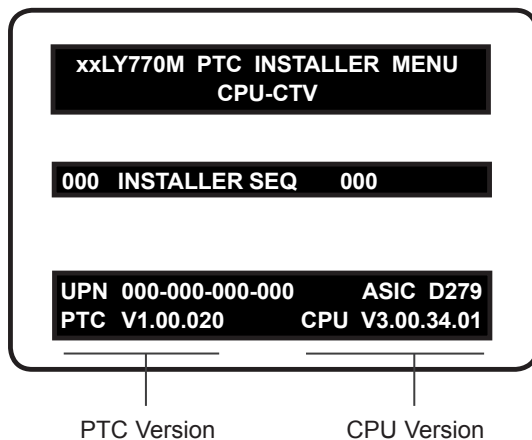

Typical Installer Menu

The Installer Menu header will vary depending on the TV you are setting up. In the Installer Menu footer, you can see the current software versions of the TV, as indicated.

Note: If the password (entry sequence) is not entered or registered correctly, you will see the message "ENTER PASSWORD 0000" at the top of the screen instead of the Installer Menu header. Once you re-enter the correct password (e.g., press 9-8-7-6 + OK), the Installer Menu will display.

Note: If the TV is not in Pass-through Mode, the Installer Menu is accessible as read-only. Also, the TV Zone # will be indicated in the Installer Menu header under the configuration mode indicator described below.

Installer Menu (Cont.)

As part of the Installer Menu header (in all modes), two 3-character acronyms are displayed to indicate the TV's current configuration mode. The table below lists all possible mode identifiers for these TV models.

Acronym	Description
CPU-CTV	Pass-through Mode with Channel Map in CPU
CPU-FTG	FTG Mode via CPU
CPU-P:C	Application Tuning Mode via CPU
EBL-FTG	FTG Mode via EBL
EBL-LNT	SONIFI PPV Mode
MPI-EXT	External MPI Control
PTC-CTV	Pass-through Mode with Channel Map in PTC

Using the Installer Menu

Refer to the table starting on the next page for an overview of the available Installer Menu items, including their item numbers, functions, value ranges, and default values.

Installer Menu items not relevant to these TV models are not present in the Installer Menu; therefore, some numbers are missing. For example, item 006 will not appear. In addition, items that are dependent on other Installer Menu item settings will not be initially accessible. For example, item 046 STRT AUX SRCE will not display in the Installer Menu unless item 004 STRT CHANNEL is set to 0. See Installer Menu detailed descriptions for further information.

Navigation within the Installer Menu

Use the Up/Down arrow keys on the Installer Remote to sequence through the available menu items, or access an item directly by keying in the item number and then pressing **MENU**. For example, to access the SLEEP TIMER option, which is item 015, press 0-1-5 + MENU.

Changing Installer Menu Settings

To change an Installer Menu item value, use the Left/Right arrow keys on the Installer Remote, or enter a valid value directly. To save the new setting, press **OK**, or use the Up/Down arrow keys to navigate to a new Installer Menu item if you have additional items to edit. Note that invalid values will not be saved.

Exiting the Installer Menu and Activating Settings

After you have adjusted all required Installer Menu item settings, press **OK** once on the Installer Remote to save your changes; then, press **OK** again to exit the Installer Menu. Any changes you make will be stored in non-volatile memory.

Note: Each time you exit the Installer Menu in Pass-through Mode, all V-Chip (Parental Control) settings in the TV are reset to their default values; that is, the Lock System, if previously enabled from the Lock setup menu, will now be disabled, and the individual Parental Control settings will be restored to default values.



Caution: Installer Menu settings may affect options available from the TV setup menus or the Function Menu.

Installer Menu (Cont.)

Installer Menu Items 000 through 049

Item	Function	Value Range	Default Value	Brief Description of Function
000	INSTALLER SEQ	0 ~ 3	0	Leave default set to 0.
001	POWER MANAGE	0 ~ 7	0	Selects the number of hours of inactivity allowed before the TV automatically turns itself OFF. Set to 0 to disable Power Management.
002	AC ON	0 ~ 3	0	Set to 1 to enable TV to turn ON when AC power is applied. Set to 2 or 3 to enable Instant ON when AC power is applied. (See detailed descriptions.)
003	BAND/AFC	0 ~ 3	1	Selects Tuning Band: 0=Broadcast, 1=CATV, 2=HRC, 3=IRC
004	STRT CHANNEL	0 ~ 127, 253, 255	255	Channel tuned when TV is turned ON. (Set to 255 to tune to channel tuned before TV turned OFF.)
005	CHAN LOCK	0 / 1	0	If set to 1, cannot tune from current channel.
007	STRT VOLUME	0 ~ 63, 255	255	Volume level when TV is turned ON. (Set to 255 to use volume level before TV turned OFF.)
008	MIN VOLUME	0 ~ 63	0	Sets minimum allowable volume setting.
009	MAX VOLUME	0 ~ 63	63	Sets maximum allowable volume setting.
010	MUTE DISABLE	0 / 1	0	Set to 1 to disable Mute Function.
011	KEY DEFEAT	0 / 1	1	If set to 1, joystick button menu navigation functions (with the exception of the input list) on display panel are not available.
012	IR BANKS ENABLE	0 / 1	0	Set to 1 to enable TV to respond to bank discrete IR codes.
013	SCAN MODE	0 / 1	1	Set to 1 to allow Channel Up/Down to turn ON TV. (See detailed descriptions.)
014	STRT CH IN SM	0 / 1	0	Set to 1 to use the Start Channel for the Channel Map pivot point in Scan Mode.
015	SLEEP TIMER	0 / 1	1	Set to 1 to enable Sleep Timer.
016	EN TIMER	0 / 1	1	Set to 1 to enable On/Off Timers.
017	ALARM	0 / 1	1	Set to 1 to enable Alarm.
020	FEATURE LEVEL	0, 16 ~ 24, 64 ~ 65	1	Determines an additional IR code scheme to which the TV will respond.
021	V-CHIP	0 / 1	1	Set to 1 to enable V-Chip (Parental Control) functions.
022	MAX BLK HRS	0 ~ 99	12	Sets number of V-Chip blocking hours.
023	CAPTION LOCK	0 / 1	0	Set to 1 to retain caption setting set before TV turned OFF.
025	FUNCTION PRE.	0 / 1	1	Set to 1 to allow Channel Preview/Banks Setup Menu access via CH PREVIEW key on Installer Remote.
027	HOSPITAL MODE	0 ~ 162, 254	254	Set according to the speaker selection, the pillow speaker code/supply voltage, and the hospital IR code. See detailed instructions.
028	CH. OVERRIDE	0 / 1	1	If set to 0, user access to channel settings in the TV setup menus is restricted and users can only tune to channels that are included in the channel lineup.
029	OLD OCV	0 / 1	0	Set to 1 to remap the PTC's direct tune channels for Aux inputs from 13x to 9x.
030	ACK MASK	0 / 1	0	If set to 1, enables ACK feature of MPI.
031	POLL RATE	20 ~ 169	94	Selects poll rate for MPI.
032	TIMING PULSE	186 ~ 227	207	Sets baud rate for MPI.
035	HDMI1 ENABLE	0 ~ 2	1	Set to 0 to disable HDMI 1. Set to 1 (DTV Mode) or 2 (PC Mode), as applicable, to enable HDMI 1.
039	REAR AUX EN.	0 / 1	1	Set to 1 to enable display panel Video 1 input jack.
041	SIMPLINK EN	0 / 1	0	Determines the status of the SIMPLINK feature. (See detailed descriptions.)
042	AUTO INPUTS	0 ~ 255	0	Determines the Aux inputs for which auto-sensing is enabled. (See detailed descriptions.)
046	STRT AUX SRCE	1, 3, 5, 255	255	Sets the starting Aux source (if item 004 STRT CHANNEL is set to 0).
047	AUX STATUS	0 / 1	0	Set to 1 for MPI Aux source to be reported as a channel number instead of Channel 0.
049	DIS. AUDIO M.	0 ~ 7	0	Determines the availability of the Sound Out (Audio) Menu in the TV menus, as well as the default Audio Mode when TV is turned ON. (See detailed descriptions.)

Installer Menu (Cont.)

Installer Menu Items 053 through 122

Item	Function	Value Range	Default Value	Brief Description of Function
053	DIS. CH-TIME	0 / 1	0	Set to 1 to disable Channel-Time display.
069	EN. CH-T COL.	0 / 1	1	Set to 1 to enable custom color for the Channel-Time display.
070	FOR. CH-TIME	0 ~ 7	2	Chooses custom foreground color for the Channel-Time display.
071	BCK. CH-TIME	0 ~ 7	2	Chooses custom background color for the Channel-Time display.
073	CH NOT AVBLE	0 / 1	0	If set to 1 and item 028 CH. OVERRIDE is set to 0, a "CHANNEL NOT AVAILABLE" message is displayed if user attempts to direct tune a channel that is not included in the channel lineup.
075	REVERT CH	0 / 1	0	If set to 1 and loss of MPI communication occurs, TV tunes to Start Channel.
077	QUICK SHUTOFF	0 ~ 17	0	Allows TV to be turned OFF with press and hold of pillow speaker channel buttons. Set to 0 to disable. Set from 1 to 17 to define hold time. (See detailed descriptions.)
078	UPN MSB	0 ~ 255	255	User programmable number, most significant byte.
079	UPN MSB-1	0 ~ 255	255	User programmable number, most significant byte - 1.
080	UPN MSB-2	0 ~ 255	255	User programmable number, most significant byte - 2.
081	UPN LSB	0 ~ 255	255	User programmable number, least significant byte.
082	CHKSM ERROR	0 / 1	1	Enforces rigid MPI checksum.
083	HANDSHK TIME	0 ~ 5	5	Relaxes MPI timing to be compatible with PC-based Windows-controlled systems.
084	PERMANENT BLK	0 / 1	0	Removes block hours setting for Parental Control and makes block permanent.
086	V. MUTE TIME	0 ~ 50	0	Use to extend the normal video mute time during channel change.
088	EN NOISE MUTE	0 / 1	1	(Analog channels only) If set to 1, audio is muted if no signal is present.
090	KEY LOCK	0 / 1	0	If set to 1, all display panel joystick button functions are locked. IR is still functional.
091	HDMI2 ENABLE	0 ~ 2	1	Set to 0 to disable HDMI 2. Set to 1 (DTV Mode) or 2 (PC Mode), as applicable, to enable HDMI 2.
094	SAP MENU EN	0 / 1	1	Set to 1 to enable SAP feature in Function Menu.
096	DEF. ASP. RATIO	0 ~ 4	2	Sets default aspect ratio at power up. See detailed descriptions and item 106.
097	AUDIO OUTPUT	0 ~ 9	7	Set as required in accordance with external audio equipment connected to the TV. See detailed descriptions.
098	PRO:CENTRIC	0 ~ 3	0	Set to 0 to disable Pro:Centric operation. Set to 1 for Flash Mode. Set to 2 for GEM (Java Application) Mode. Set to 3 for HTML Mode.
099	BACK LIGHTING	1 ~ 202, 255	255	Sets the level of the TV picture back lighting. (See detailed descriptions.)
101	IR FEEDBACK	0 / 2	0	Set to 2 to disable the TV's Bluetooth feature.
102	ATSC BAND	0 ~ 4	4	Selects ATSC band.
103	ATSC TUNE MODE	0 / 1	1	Set to 1 (default) for Physical Channel scan. Set to 0 for Virtual Channel scan.
104	START MINOR CH	0 ~ 255	0	Selects Minor Start Channel. Set to 0 for NTSC.
106	ASP RATIO LOCK	0 / 1	0	To retain set aspect ratio on power cycle, set to 1. Set to 0 for default ratio on power cycle.
116	VIDEO MUTE EN	0 / 1	0	(Analog channels only) If set to 1, video mutes (blank screen) when no signal is present.
117	FACT DEFAULT	0 / 1	0	Set to 1 to restore the factory default settings of all Installer Menu items.
118	POWER SAVINGS	1, 3, 7	3	Determines the powered status of the embedded b-LAN module and the GAME CONTROL/MPI port. (See detailed descriptions.)
119	DATA CHANNEL	0 ~ 135, 253, 255	255	Set to 0 to disable. Set from 1 to 135 to match the RF channel number used by the Pro:Centric server as its data channel. Set to 255 to use Auto Search to find the Pro:Centric RF channel. (See detailed descriptions.)
121	UPDATE TIME HR	0 ~ 23, 128	128	Sets the Wake For Update hour. The value "128" is displayed as "OFF." Directly entering 128 turns the Wake For Update feature OFF.
122	UPDATE TIME MN	0 ~ 59, 255	0	Sets the minute for Wake For Update. (See detailed descriptions.)

Detailed Descriptions of Installer Menu Items

000 - INSTALLER SEQUENCE

Specifies entry sequence to the Installer Menu.

0 = 9876 1 = 4321
2 = 1478 3 = 3698

001 - POWER MANAGE (Power Management)

Energy saving feature. Determines the number of hours, in the range 1 to 7, of inactivity allowed, either at the TV control panel or from the remote, before the TV automatically turns itself OFF. If set to 0, Power Management is disabled.

002 - AC ON (AC Power Switchable)

If set to 1, this allows the TV to turn ON when AC power is applied. Pressing the POWER button is not necessary. This is desirable if the TV is plugged into a switched AC outlet (i.e., a set-top box). Set to 2 or 3 to enable the Instant ON feature (see additional information below). Set to 0 (default) for standard TV turn ON/OFF operation.

The Instant ON feature allows the TV to turn ON when AC power is applied, but with video and audio muted (Muted ON). The TV retains its ON status while appearing to be OFF. Pressing the POWER button toggles Off/On the video and audio mutes, so that the TV appears to turn ON instantly.

- If this item is set to 2, the TV will reboot to check for and download updates from the Pro:Centric server at every turn OFF. This setting is not recommended if the TV will be configured with a resident application.
- If this item is set to 3, the TV will not reboot to check for and download updates at turn OFF. This setting is recommended if the TV will be configured with a resident application. In this mode, the check for and download of updates is under application control. Refer to your site-specific documentation for further information on configuring the TV with a resident application.

When this item is set to 2 or 3, the TV will reboot once every 24 hours and, if applicable (i.e., item 119 DATA CHANNEL is set), check for and download updates from the Pro:Centric server. The time at which this event occurs depends on the setting of item 121 UPDATE TIME HR. See item 121 description for further information. Once the update cycle is complete, the TV completes the reboot and resumes its Muted ON state.

Note: If set to 1, the TV does not respond to ON/OFF commands from either the remote or the display panel, and the SLEEP TIMER is also nonfunctional.

003 - BAND/AFC (Band/Automatic Frequency Control)

There are four possible settings for this option:

0 = Broadcast 1 = CATV (default)
2 = HRC 3 = IRC

If some channels were not found by Auto Tuning (Channel Search), select the appropriate Band setting here, and add the channels using the Channel Edit option in the Channel Menu.

004 - STRT CHANNEL (Start Channel)

If active, this function allows you to determine the initial Major Start Channel number when the TV is turned ON. This feature is useful for an in-house information channel, since the TV would always select that channel when it is turned ON. If set to 255, the last channel tuned before the TV was turned OFF will be the channel tuned when the TV is turned ON again.

0 = Aux 127 = Map to Major CH 4
1 ~ 125 = Major Ch. # 253 = IP Start Channel
126 = Map to Major CH 3 255 = Last Channel

Note: For a digital Start Channel, always remember to set item 104 to the Minor Start Channel number.

Note: 126 and 127 are mapped only in SONIFI PPV Mode.

Note: The IP Start Channel shown above can only be set in the FTG File Manager, which is used to configure TV CPUs for FTG Mode. The same applies for the additional Major Channel number range of 128 ~ 135 in Physical tuning and 128 ~ 999 in Virtual tuning mode. This means that these values, if set, will only be visible in the read-only Installer Menu when the TV is in FTG Mode. The read-only display also will show additional information about the channel, for example, the IP address and port number, etc.

005 - CHAN LOCK (Channel Lock)

Channel Lock is ideal if the system must always be on the same channel. Changing channels with the Channel Up/Down or keypad numbers is impossible. Channel Lock is inactive if set to 0 (default).

Generally, this feature is used in connection with item 004 STRT CHANNEL where the Start Channel may, for example, be set to 3 or 4. If the Start Channel is 3, then the TV will remain locked on channel 3.

NOTE: For items 007, 008, and 009
For legacy reasons, the scale used is 0–63. The PTC software will translate this to the 0–100 scale used by the TV.

To translate a TV volume level to the Installer Menu value, use the following formula:

$$\text{Installer Value} = \frac{\text{TV Value} \times 63}{100}$$

Enter only the whole number (disregard fractions).

007 - STRT VOLUME (Start Volume)

This function allows the Installer to determine the initial volume level setting when the TV is turned ON. This feature is useful for an in-house information channel, since the TV will always select that volume level when it is turned ON. The range of values is 0 to 63, 255. If set to 255, the last volume level before the TV was turned OFF will be the current volume level when the TV is turned ON again.

Installer Menu (Cont.)

008 - MIN VOLUME (Minimum Volume)

This function determines the minimum volume level allowable with the Volume (VOL) Up/Down control. In this way, for example, someone cannot set the volume too low to hear. The value range is from 0 to 63. The factory default is 0, which provides the full range of volume control, if item 009 MAX VOLUME is set to 63. It is recommended to set the same value on every TV.

Note: The minimum volume level cannot have a value setting higher than the maximum volume level (described below).

009 - MAX VOLUME (Maximum Volume)

This function determines the maximum volume level allowable with the Volume (VOL) Up/Down control. In this way, for example, someone cannot set the volume level high enough to disturb others. The value range is 0 to 63, with 63 as the default, which gives the user the full range of volume control, if item 008 MIN VOLUME is set to 0. It is recommended to set the same value on every TV.

Note: The maximum volume level cannot have a value setting lower than the minimum volume level (described above).

010 - MUTE DISABLE

Enables or disables sound mute function. If set to 1, sound cannot be muted. If set to 0, sound can be muted.

011 - KEY DEFEAT

If set to 1, Key Defeat is enabled, which means that, with the exception of the input list, end users cannot access or navigate within the on-screen menu(s) from the display panel; i.e., joystick button menu navigation functions (input list excepted) will not be available. Set to 0 to disable Key Defeat. Note that all IR features remain functional regardless of this setting.

Note: Users can always access the menus by pressing MENU on the remote.

012 - IR BANKS EN (IR Banks Enable)

For direct access to a particular channel bank. When enabled, you can access a channel bank by inputting the discrete IR code for that bank.

Note: This item is not available in the Installer Menu when item 027 HOSPITAL MODE is set to 0.

013 - SCAN MODE (Functional after Express Script transfer of channel lineup to PTC)

When set to 1 (default), allows TV to be turned ON when Channel Up/Down buttons are pressed on pillow speaker. Also, TV will turn OFF when Channel Up/Down key is used to tune above or below Channel Map pivot point. By default, Channel Map pivot point is between the highest and lowest channel in the Channel Map (also see item 014 STRT CH IN SM). Set to 0 to disable.

014 - STRT CH IN SM (Start Channel in Scan Mode)

Only valid when item 013 SCAN MODE is set to 1 (enabled). When set to 1, forces Channel Map pivot point to be between the RF channel designated in item 004 STRT CHANNEL and next lower channel in the Channel Map. Set to 0 to disable (default).

Note: This item is not available in the Installer Menu when item 013 SCAN MODE is set to 0.

015 - SLEEP TIMER

If set to 1, the Sleep Timer feature may be used. If set to 0, the Sleep Timer is not available.

016 - EN TIMER (Enable On/Off Timers)

If set to 1, the Timer function is available to the end user and enabled continuously. Set to 0 to disable On/Off timers.

Note: The TV clock must be set in order for timers to be used.

017 - ALARM

Gives the installer the option of making the Alarm function available to the end user. If set to 1, the Alarm function is available to the end user. Set to 0 to disable the Alarm function.

Note: The TV clock must be set before the Alarm function will work.

020 - FEATURE LEVEL

This function determines an additional IR code scheme to which the TV will respond, allowing for the use of unique IR codes based on "bed number" in a multi-TV single room installation. First determine the IR mode; then select the bed number.

Note: Item 027 HOSPITAL MODE must be set to 0 to enable Legacy Zenith Bed 1 or Bed 2 IR codes and Speaker selections.

Values	IR Mode	Bed #	Speaker
0-1	Legacy Zenith (Hospital)	1-2	TV
16-24	Multi-code Remote	1-9	TV
64-65	Legacy Zenith (Hospital)	1-2	Pillow

Note: For further information, see documentation for the accessory package that includes the multi-code remote.

021 - V-CHIP (Parental Control)

Set to 1 to activate V-Chip (Parental Control) and have it available to the end user to filter and control or otherwise restrict programming content that can appear. Set to 0 to turn the V-Chip feature Off (not available to user); no programming restrictions can be set.

022 - MAX BLK HRS (Maximum Block Hours)

Sets hours from 0 to 99 for the maximum V-Chip (Parental Control) block hours. Default setting is for 12 blocking hours.

Note: This item is not available in the Installer Menu when item 021 V-CHIP is set to 0 or when item 084 PERMANENT BLK is set to 1.

023 - CAPTION LOCK

If set to 0, captions are OFF when the TV is turned ON. Set to 1 to use the caption setting configured before the TV was turned OFF when the TV is turned ON.

025 - FUNCTION PRE (Function Preview)

Set to 1 to allow access to the Channel Preview/Banks Setup Menu via the CH PREVIEW key on Installer Remote. Set to 0 to disable access to the Channel Preview/Banks Setup Menu.

027 - HOSPITAL MODE

Set according to the speaker selection, the pillow speaker code/ supply voltage and the hospital IR code. If using a Pro:Centric pillow speaker, select one of the Zenith codes in accordance with the desired speaker selection. See table below.

Value	Speaker	Pillow Speaker Code/Voltage	Hospital IR Code
000	Determined by item 020 setting	Zenith (+12v)	Determined by item 020 setting
001	Pillow Only	Zenith (+12v)	Zenith Bed #1
002	Pillow Only	Zenith (+12v)	Zenith Bed #2
017	Pillow Only	Philips (+5v)	Zenith Bed #1
018	Pillow Only	Philips (+5v)	Zenith Bed #2
033	Pillow Only	RCA (-5v)	Zenith Bed #1
034	Pillow Only	RCA (-5v)	Zenith Bed #2
065	TV Only	Zenith (+12v)	Zenith Bed #1
066	TV Only	Zenith (+12v)	Zenith Bed #2
081	TV Only	Philips (+5v)	Zenith Bed #1
082	TV Only	Philips (+5v)	Zenith Bed #2
097	TV Only	RCA (-5v)	Zenith Bed #1
098	TV Only	RCA (-5v)	Zenith Bed #2
129	Both Pillow & TV	Zenith (+12v)	Zenith Bed #1
130	Both Pillow & TV	Zenith (+12v)	Zenith Bed #2
145	Both Pillow & TV	Philips (+5v)	Zenith Bed #1
146	Both Pillow & TV	Philips (+5v)	Zenith Bed #2
161	Both Pillow & TV	RCA (-5v)	Zenith Bed #1
162	Both Pillow & TV	RCA (-5v)	Zenith Bed #2
254	TV Only	Disabled (0v)	Zenith Bed #2

When Hospital Mode is enabled and the TV is in Pass-through Mode, channel banks are also available. Refer to channel banks information in this document for further details.

Channel banks are not supported if Hospital Mode is set to 0 or on TVs that are configured for FTG Mode operation.

When Hospital Mode is set to 0 (disabled), both the IR code that will control the TV and the speaker selection depend on the Installer Menu item 020 FEATURE LEVEL setting.

Note: The default setting (254) is not selectable in the Installer Menu. If you ever need to restore the default setting, you must set item 117 FACT DEFAULT to 1 to reload the factory default settings. See item 117 description for further information.

Note: In the Installer Menu, an informational code is displayed at the right of each Hospital Mode value. Each code consists of three characters. The first character—T, P, or B—identifies the speaker: TV, Pillow, or Both. The second character—Z, P, R, or D—identifies the pillow speaker code: Zenith, Philips, RCA, or Disabled. The third character—1 or 2—identifies the bed number. In the table on the previous page, each bolded character represents an element of the Hospital Mode code.

028 - CH. OVERRIDE (Channel Override)

Applicable for Pass-through Mode only. If set to 1, users can select channels either with Channel Up/Down or by direct keypad entry. This setting also allows full access to channel settings in the TV setup menus (i.e., channels may be added or removed from the channel lineup, channel labels and icons may be edited, etc.). If set to 0, the channel lineup is locked. That is, user access to channel settings in the TV setup menus is restricted, and users can only tune to the channels that are included in the channel lineup. Also, in this case, users can only select channels using Channel Up/Down; direct keypad entry is not available.

029 - OLD OCV (On Command Video™)

Set to 1 to remap the PTC's direct tune channels for Aux inputs from 13x to 9x. This allows 2-digit only tuning systems (i.e., legacy OCV) to direct tune Aux inputs. See also Reference section, "TV Aux Input Configuration."

030 - ACK MASK

MPI Communication Parameter. When set to 1, enables ACK feature of MPI.

031 - POLL RATE

MPI Communication Parameter. Selects poll rate for MPI. Step size of 16 ms. Changing from default may affect communication via MPI.

032 - TIMING PULSE

MPI Communication Parameter. Sets baud rate for MPI. Step size of 4.3 uS. Changing from default may affect communication via MPI.

035 - HDMI1 ENABLE

Set to 1 to enable HDMI 1 input in DTV Mode. Set to 2 to enable HDMI 1 input in PC Mode. Set to 0 to disable display panel HDMI 1 input.

039 - REAR AUX EN. (Rear Aux Enable)

Set to 1 to enable display panel rear Aux (Video 1) input. Set to 0 to disable display panel rear Aux (Video 1) input.

Installer Menu (Cont.)

041 - SIMPLINK EN

Set to 0 to disable the SIMPLINK feature. Set to 1 to enable SIMPLINK functionality (does not enable remote control access to the SIMPLINK Menu).

Note: When both this item *and* item 042 AUTO INPUTS are enabled in the Installer Menu, HDMI inputs will be detected by SIMPLINK, but the Auto Input(s) Sensing Feature will not function.

042 - AUTO INPUTS

Determines the Aux inputs for which auto-sensing is enabled. Set to 0 to disable auto-sensing for all available inputs. Set to 255 to enable auto-sensing for all available inputs. For information on options for individual input settings, see Reference section, "Auto Input(s) Sensing Feature."

Note: In order for auto-sensing to be enabled for an input, that input must also be enabled in the Installer Menu. For example, to enable auto-sensing for HDMI 1, item 035 HDMI1 ENABLE must also be set to 1 or 2. Also, see note above regarding TV operation when both this item and item 041 SIMPLINK EN are enabled.

046 - STRT AUX SRCE (Start Aux Source)

Sets the starting Aux source. When turned ON, the TV will tune to starting Aux source if item 004 STRT CHANNEL is set to 0.

1 = Video 1 5 = HDMI 2 255 = Last Aux
3 = HDMI 1

Note: Above is applicable only if all Aux sources are enabled.

Note: This item is not available in the Installer Menu unless item 004 STRT CHANNEL is set to 0.

047 - AUX STATUS

Set to 1 for MPI Aux source to be reported as a channel number instead of channel 0. Set to 0 to disable Aux identification change. Controls MPI status channel response for Aux inputs.

049 - DIS. AUDIO M. (Disable Audio Menu)

Determines the availability of the Sound Out (Audio) Menu in the TV menus. Also determines the default Audio Mode when TV is turned ON. See the table below and set as required.

Value	Sound Out (Audio) Menu Status	Default Audio Mode at TV Turn ON
0 (default)	Enabled	Internal TV Speaker
1	Disabled	Internal TV Speaker
2	Enabled	External Speaker (optical or HDMI)
3	Disabled	External Speaker (optical or HDMI)
4	Enabled	LG Sound Sync (optical)
5	Disabled	LG Sound Sync (optical)
6	Enabled	LG Sound Sync (BT wireless)
7	Disabled	LG Sound Sync (BT wireless)

Note: If a SIMPLINK-enabled device is connected to the TV and item 041 SIMPLINK EN is set to 1 (enabled), the SIMPLINK device Audio Mode will have priority over the setting of this item when the TV is turned ON.

053 - DIS. CH-TIME (Disable Channel-Time)

Set to 1 to disable the Channel-Time display; Channel-Time display will not appear. Set to 0 to enable the Channel-Time display.

069 - EN. CH-T COL. (Enable Channel-Time Custom Color)

Set to 1 to enable custom color for the Channel-Time display. Set to 0 to disable custom color for the Channel-Time display.

070 - FOR. CH-TIME (Channel-Time Display Foreground Color)

Set according to Color Chart:

0 = Black 3 = Cyan 6 = Yellow
1 = Blue 4 = Red 7 = White
2 = Green 5 = Violet

Note: If foreground color and background color are the same, the menu background will be transparent.

Note: Applies only to "Channel Not Available" message if item 073 CH NOT AVBLE is set to 1 (enabled). Also, items 070 FOR. CH-TIME and 071 BCK. CH-TIME are not available in the Installer Menu when item 069 EN. CH-T COL. is set to 0.

071 - BCK. CH-TIME (Channel-Time Display Background Color)

See description for item 070 FOR. CH-TIME above. The color chart is the same for both items.

073 - CH NOT AVBLE (Channel Not Available)

If set to 1 and item 028 CH. OVERRIDE is set to 0, a "CHANNEL NOT AVAILABLE" message is displayed when a user attempts to direct tune a channel that is not included in the channel lineup.

Note: This item is not available in the Installer Menu when item 028 CH. OVERRIDE is set to 1.

075 - REVERT CH (Revert to Start Channel)

If set to 1 and loss of MPI communication occurs, TV automatically tunes to the specified Start Channel.

Note: This item is not available in the Installer Menu when item 004 STRT CHANNEL is set to 255.

077 - QUICK SHUTOFF

Allows end user (patient) to turn OFF TV using mechanical (analog) Pillow Speaker Channel Up/Down buttons. Patient needs to press and hold either channel button for time determined by value set. Set to 0 to disable. Set from 1 to 17 to establish required hold time of button—from 2 seconds to 10 seconds in half-second increments.

Note: This item is not available in the Installer Menu when item 013 SCAN MODE is set to 0.

078 - UPN MSB (UPN Most Significant Byte)

User programmable number, most significant byte readable by MPI command. Note: Not linked to serial number.

079 - UPN MSB-1 (UPN Most Significant Byte-1)

User programmable number, most significant byte-1 readable by MPI command. Note: Not linked to serial number.

080 - UPN MSB-2 (UPN Most Significant Byte-2)

User programmable number, most significant byte-2 readable by MPI command. Note: Not linked to serial number.

081 - UPN LSB (UPN Least Significant Byte)

User programmable number, least significant byte readable by MPI command. Note: Not linked to serial number.

082 - CHKSM ERROR (Checksum Error)

Enforces rigid MPI checksum validation. Set to 1 for validation. Set to 0 to disable (does not check checksum on MPI async port). SPI is always checked.

083 - HANDSHK TIME (Handshake Time)

Adds an additional delay to the handshake time which is 64 msec, thus relaxing MPI timing requirements to be compatible with PC-based Windows controlled systems. Range is 0 - 5. (Timeout = 25.5MS + [25.5 MS* Handshake time].)

084 - PERMANENT BLK (Permanent Block)

Allows Lock (Parental Control) blocking schemes to be permanent by disabling the blocking hours function. Set to 1 to install Parental Control restrictions permanently. Set to 0 for user-specified hours control of blocking schemes.

Note: This item is not available in the Installer Menu when item 021 V-CHIP is set to 0.

086 - V. MUTE TIME (Video Mute Time)

Use to extend the normal video mute time during channel change. For example, you may wish to extend the normal video mute time to prevent the display of encrypted video (i.e., from a Pro:Idiom encrypted channel) that has not yet been decrypted. When set to 0, the normal video mute time is not extended. Set from 1 to 50 to increase the normal video mute time in 100 ms step increments up to a maximum of 5 seconds (e.g., the value of 25 represents 2.5 seconds, or 25 x 100 ms = 2.5 seconds).

088 - EN NOISE MUTE (Enable Noise Mute)

Applicable for analog channels only. If set to 1, audio mutes if no signal is present.

090 - KEY LOCK

If set to 1, Key Lock is enabled, which means that all display panel joystick button functions will be locked, i.e., non-functional. Set to 0 to disable Key Lock. Note that all IR features remain functional regardless of this setting.

091 - HDMI2 ENABLE

Set to 1 to enable HDMI 2 input in DTV Mode. Set to 2 to enable HDMI 2 input in PC Mode. Set to 0 to disable display panel HDMI 2 input.

094 - SAP MENU EN (2nd Audio Program)

Set to 1 to enable the SAP feature in the Function Menu, when the Function Menu is available (i.e., TV is not in Pass-through Mode). Set to 0 to disable the SAP feature in the Function Menu, when the Function Menu is available.

096 - DEF. ASP. RATIO (Default Aspect Ratio)

Selects default aspect ratio at power up:

0 = Set By System	1 = 4:3
2 = 16:9 (default)	3 = Just Scan
4 = Zoom	

Note: This item is not available in the Installer Menu unless item 106 ASP RATIO LOCK is set to 0.

097 - AUDIO OUTPUT

Determines availability and signal type/level (fixed speaker, variable speaker, or fixed line level [amplifier]) of the audio output to be used by external audio equipment connected to the SPEAKER OUT / LINE OUT jack on the TV. Set to 0 to disable audio output. Otherwise, see the table below and set as required in accordance with audio equipment. See also Reference section, "External Stereo Speaker Specifications."

	Value	Status
Speaker Output	1	Fixed 0.01 Watts
	2	Fixed 0.03 Watts
	3	Fixed 0.05 Watts
	4	Fixed 0.10 Watts
	5	Fixed 0.20 Watts
	6	Fixed 0.50 Watts
	7	Fixed 1.00 Watt (default)
	8	Control with volume
Line Output	9	Fixed line level (typically 400 mVrms ± 100 mVrms @10KΩ) output

098 - PRO:CENTRIC

Selects the Pro:Centric Application Mode. Set to 0 (default) to disable the Pro:Centric application. Set to 1 for Flash Mode. Set to 2 for GEM (Java Application) Mode. Set to 3 for HTML Mode.

The TV must be turned OFF for a few seconds to initiate the Pro:Centric application download. When the TV is turned back ON, it may take several minutes to load the Pro:Centric application after the initial download.

Note: This item is not available in the Installer Menu when item 119 DATA CHANNEL is set to 0.

Installer Menu (Cont.)

099 - BACK LIGHTING

Sets the TV screen brightness at power up. Default setting is 255.

- 1 (dimpest picture)– 100 (brightest picture) Static Back Lighting
- 101 (dimpest picture)– 200 (brightest picture) Dynamic Back Lighting: The TV automatically controls back lighting depending upon the picture level of the current program.
- 201 Automatic Static Back Lighting: The TV automatically controls back lighting by using Intelligent Sensor to detect the level of ambient lighting.
- 202 Automatic Dynamic Back Lighting: The TV automatically controls back lighting by using Intelligent Sensor to detect the level of ambient lighting and depending upon the picture level of the current program.

If set to 201 or 202, back lighting can be controlled via the Picture settings in the TV setup menus. However, each time the TV is turned ON, Picture Mode (set in Picture Menu) is defaulted to Intelligent Sensor. If Picture Mode is manually set to a static option (Vivid, Standard, etc.) during a viewing session, Intelligent Sensor is temporarily disabled.

If set to 255, back lighting is controlled via the Picture settings in the TV's setup menus.

101 - IR FEEDBACK

If set to 0, the TV's Bluetooth feature is enabled (default). If set to 2, the Bluetooth feature is disabled.

Note: Bluetooth may be used in selected installation environments, with Bluetooth enabled devices, for example, an LG Magic Motion Remote (MMR). However, depending on the application for which the TV is installed, you may need to disable Bluetooth.

102 - ATSC BAND

Sets up TV to receive different types of incoming signals:

0 = Broadcast	1 = CATV	2 = HRC
3 = IRC	4 = Same as NTSC	

103 - ATSC TUNE MODE

Sets ATSC tuning mode. Default set to 1 for Physical Channel scan. Set to 0 for Virtual Channel scan.

104 - START MINOR CHANNEL

Sets Minor Start Channel number at power up. 0 = NTSC. If not 0, number selected is the digital channel's Minor Start Channel number.

Note: This item is not available in the Installer Menu when item 004 STRT CHANNEL is set to 0 or 255.

106 - ASP RATIO LOCK (Aspect Ratio Lock)

Set to 1 to retain previous aspect ratio with power off. Set to 0 to retain default aspect ratio with power off. See item 096 DEF. ASP. RATIO above.

116 - VIDEO MUTE EN (Video Mute Enable)

Applicable for analog channels only. If set to 1, video mutes (blank screen) when no signal is present.

117 - FACT DEFAULT (Factory Default)

Set to 1 and press OK to restore the factory default settings of all Installer Menu items. Once complete, the value returns to 0.



Caution: If set to 1, this clears all Installer Menu custom settings and restores the factory default settings. It also clears the channel lineup, including any assigned channel icons and custom text labels.

Note: See also Reference section, "Restoring Factory Defaults on the TV(s)," for further information.

118 - POWER SAVINGS

Default set to 3—the power circuitry for both the embedded *b*-LAN module and the GAME CONTROL/MPI port is only powered when the TV is turned ON. When the TV is turned OFF, the embedded *b*-LAN and the GAME CONTROL/MPI port are not powered.

Note that the TV must be turned ON in order to communicate with the embedded *b*-LAN module for configuration and control when POWER SAVINGS is set to 3. If POWER SAVINGS is set to 1, the *b*-LAN module is always powered.

Similarly, if MPI communication is required for external MPI control, POWER SAVINGS should be set to 1 so that the GAME CONTROL/MPI port circuitry is always powered.

Note: See Reference section, "*b*-LAN Setup & Overview," for further information.



Caution: POWER SAVINGS should NEVER be set to 7. This setting is intended for factory use only.

119 - DATA CHANNEL

Set to 0 to disable. Set from 1 to 135 to match the RF channel number that will be used by the Pro:Centric server as its data channel. If left at the default value (255), the TV's Data Channel Auto Search feature will be enabled (see additional information below).*

Data Channel Auto Search feature: When this item is set to 255 (default), once every 24 hours, the TV will initiate a search of 10 predefined channels (10, 20, 30, ... 100) and then, if necessary, perform a complete search of the RF channels (1 to 135) in an attempt to find the RF channel used by the Pro:Centric server as its data channel. If the Pro:Centric RF channel is found, the DATA CHANNEL value will be changed from 255 to match the server's RF channel number. The time at which the Auto Search occurs depends on the setting of item 121 UPDATE TIME HR. See item 121 description for further information.

* PCS150R and later Pro:Centric servers do not support HRC or IRC cable channel frequencies.

Note: Pro:Centric application updates are downloaded from the Pro:Centric server to the TV when the TV is turned ON; however, TV E-Z Installation updates are downloaded to the TV when the TV is turned OFF. While E-Z Installation updates are in progress, it is not possible to turn ON the TV.

Note: The Data Channel is automatically set to "253" if Media Type is set to "IP" in the EZ-Manager Wizard or Express Script or in the IP Environment / Pro:Centric Menu on the TV (see "LG Setup Wizard" on pages 12 to 13 or "Pro:Centric Setup" on pages 65 to 67, respectively) or if Installer Menu item #119 Data Channel is set to "IP Address" in the FTG File Manager, which is used to configure TV CPUs for FTG Mode via CPU operation. It is not possible to change the value to "253" directly in the Installer Menu.

121 - UPDATE TIME HR

Based on the settings of this item and item 122 UPDATE TIME MN, the Wake For Update feature wakes the TV once daily to check for and, if applicable, download updates from the Pro:Centric server.

Set the Wake For Update hour from 0 to 23. This item uses the 24-hour clock format. The value "128" (default) is displayed as "OFF." Directly entering 128 resets the default value (OFF) for this item, though note that this setting does not mean the TV will not initiate update events—see additional information below.

Under standard TV OFF/ON operating conditions (i.e., item 002 AC ON is set to 0), a Wake For Update event occurs when the TV is OFF and causes the TV's CPU to temporarily turn ON, perform the update cycle, and then turn back OFF, all while the TV appears to be OFF. If item 002 AC ON is set to 2 or 3 for Instant ON, then the TV's CPU is always ON and Wake For Update occurs when the TV is in its Muted ON state (i.e., the TV only appears to be OFF). The Wake for Update event causes the TV's CPU to reboot in order to perform the update cycle and then return to its Muted ON state. See also description for item 002.

Random Distribution of Update Time: If this item is set to 128 (OFF), the time at which either a Data Channel Auto Search (item 119 set to 255) and/or an Instant ON update (item 002 set to 2 or 3) occurs is determined as follows: Each TV initiates the search and/or checks for updates during the 2 AM hour (if the TV clock is set) or after two hours of elapsed time from when AC power was applied (if the TV clock is not set). Also, in this case, a fixed update time minute from 0 to 59 that has been assigned to each TV is used. (The intention of this feature is to prevent all of the installed TVs from performing updates at the same time; however, note that in installations that have a large quantity of TVs with this feature, there will be some TVs that have the same update minute assignments.) The update time for the TV is displayed at the right of this item in the Installer Menu, for example:

121 UPDATE TIME HR OFF 02:34

If the TV display is ON when a Wake For Update event is to occur, the update will take place the next time the TV is turned OFF.

Note: This item is not available in the Installer Menu when item 119 DATA CHANNEL is set to 0, except when item 002 AC ON is set to 2 or 3 for Instant ON.

Note: The TV clock must be set in order for a Wake For Update event to occur at the precise time of day in accordance with item 121 and item 122 settings.

122 - UPDATE TIME MN

Set the Wake For Update minute from 0 to 59. If item 121 is NOT set to 128 and you wish to invoke the "random" minute assignment on the TV, set this item to 255. See also description for item 121 UPDATE TIME HR above.

Note: This item is not available in the Installer Menu unless item 121 UPDATE TIME HR is set from 0 to 23.

Note: The TV clock must be set in order for a Wake For Update event to occur at the precise time of day in accordance with item 121 and item 122 settings.

Custom Master TV Setup

This section describes how to create a customized Master TV Setup for cloning purposes when the TV is in Pass-through Mode. The Master TV Setup can be used to configure either TVs that are to remain in Pass-through Mode or TVs that are to be configured for FTG Mode via CPU.

Note: Cloning requirements and procedures are described in detail on pages 53 to 58.

Note: You can use the FTG File Manager to create an FTG Configuration (.tlx) file for FTG Mode via CPU configuration, if desired (see pages 59 to 60). However, it is not possible to customize TV setup menu settings in the FTG File Manager. If you wish to include customized TV setup menu settings in the TV configuration, in addition to the channel lineup and Installer Menu settings, perform the Master TV Setup procedure to create the configuration file.

Before You Begin

- It is recommended that you disconnect all Aux inputs if you intend to run Auto Tuning (Channel Search). Under certain conditions, Auto Tuning is disabled if there is an Aux input active.
- All Learning and Teaching processes on these TV models are performed via USB memory device / TLX file. The TLX file format clones Installer Menu settings, IP Environment Menu settings (with the exception of unique TV attributes), and all TV sources' (analog, digital, AV1, HDMI, etc.) clonable setup menu settings. See also "Clonable TV Setup Menu Features" list below.
- If the TLX file contains an FTG Channel Map (created during Master TV Setup or in FTG File Manager), the Target TV(s) will be configured for FTG Mode via CPU after Teaching is performed, though as part of the Teaching process, you may have the option to select either logical or physical channel tuning. If you wish to retain the default Pass-through Mode for all Target TVs, the TLX file should not include an FTG Channel Map.

Clonable TV Setup Menu Features

Quick Settings Channels Picture Mode Sound Mode	Sound Sound Mode Sound Effects Volume Mode AV Sync. Adjust	General Language Time & Date – Clock Mode (Auto/Manual) – Time Zone Timers (No Signal Power Off) Standby Light
Picture Picture Mode Picture Adjust	Accessibility Pointer Options Closed Captions	

Note: Some menu options vary between analog and digital channels and Aux inputs.

Custom Master TV Setup Procedure

1. Turn ON the TV.

The next step depends on whether the LG Setup Wizard appears on the screen when you turn ON the TV:

- If the wizard is displayed, the TV is in the required factory default state. Exit the wizard, and then continue with step 2.
- If the wizard is not displayed, restore the TV to a factory default condition before continuing with this procedure. See Reference section, "Restoring Factory Defaults on the TV(s)," as necessary, for further information.

2. Set Installer Menu items.

This step provides specific instruction only on the Installer Menu items that should be set on a Master TV. Refer to pages 35 to 45 for detailed information on all Installer Menu items.

- Use the Installer Remote to access the PTC Installer Menu (see "Accessing the Installer Menu" on page 35 for further information).
- Set Installer Menu item **003 BAND/AFC**, as appropriate.
 - Broadcast: Set to 0.
 - CATV: Set to 1 (default).
 - HRC: Set to 2.
 - IRC: Set to 3.
- Set Installer Menu item **027 HOSPITAL MODE**, as appropriate, to select the speaker configuration.
- Set any other Installer Menu items that affect your TV programming network to the required configuration. For example, enable/disable Aux inputs, set a Start Channel, etc.
- After you have adjusted all Installer Menu item settings as required, and if you do not need to configure any IP Environment settings (see note below), press **OK** once on the Installer Remote to save your changes; then, press **OK** again to exit the menu.

Note: If you intend to configure settings in the IP Environment Menu, which is accessible from the Installer Menu, you can proceed directly to step 3. All Installer Menu settings will be saved automatically when you access the IP Environment Menu.

3. Configure IP Environment settings.

Note: You cannot return directly to the Installer Menu from the IP Environment Menu; thus, you may wish to set all Installer Menu items as needed before you access the IP Environment Menu. Otherwise, you will need to reaccess the Installer Menu to set additional items.

Navigate to Installer Menu item 119 DATA CHANNEL, and press **2-5-3 + MENU** to launch the IP Environment Menu. Then, complete network configuration as required. In particular, if you intend to use the Wi-Fi Zoning feature, you must configure the wireless network connection as part of the Master TV Setup. See "IP Environment Setup" on pages 65 to 72 for further information.

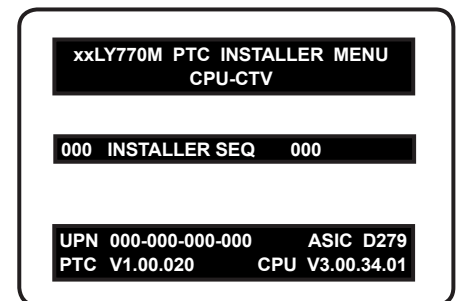

Typical Installer Menu



Adjust the values for these Installer Menu items, as required.

(Continued on next page)

Custom Master TV Setup (Cont.)

(Continued from previous page)

4. Set up TV features.

On-screen setup menus control the features of the TV. Press **MENU** on the Installer Remote to access the TV setup menus, and then set Channel, Picture, Sound, etc. options to the desired configurations. See “Clonable TV Setup Menu Features” list on page 46 and also notes below.

Note: If you intend to use the Zoning feature(s) on this TV, make sure to assign the appropriate TV Zone # and/or Wi-Fi Zone # at this time as described in Reference section, “Using the TV’s Zoning Features.”

Note: If desired and if appropriate, you can run Auto Tuning (see step 5) prior to completing this step.

5. (Optional) Run Auto Tuning.

If you are creating a Master TV Setup and you wish to retain the default Pass-through Mode for the Target TV(s), do NOT run Auto Tuning. If you Learn an auto-tuned/edited channel lineup from a Master TV Setup, thereby creating a TLX file with an FTG Channel Map, and then Teach the TLX file to a Target TV, this will put the Target TV in FTG Mode via CPU. See also notes below.

Note: When you Teach a TLX file that contains an FTG Channel Map to a Target TV (for FTG Mode via CPU configuration), you may have the option to select either logical or physical channel tuning. For either selection, the channel sequence will be based on the order in which the channels appear in FTG Channel Map. You can view and/or edit the channel sequence in the FTG File Manager, as required.

Note: Decryption of Pro:Idiom encrypted channels will not be enabled unless you use the FTG File Manager to set the channel attributes.

- a) Use the Installer Remote to access the Quick Settings Menu. Then, select **Channels > Channel Tuning** and follow the on-screen instructions to search for all available analog and digital channels.
- b) Use the **Channel Manager** option in the Channels Menu to edit the channel lineup, as necessary. Add/delete channels per your system requirements.

6. Verify the TV setup.

Make sure the TV features are set per your requirements. Also, if applicable, verify that the channel lineup is correct.

The Master TV Setup is now ready to be saved to a USB memory device. See “Cloning Procedures” on pages 53 to 58.

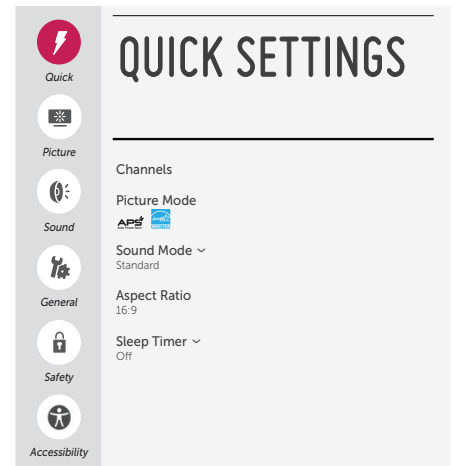

Use the TV setup menus to set the TV features to the desired configuration for the end user.

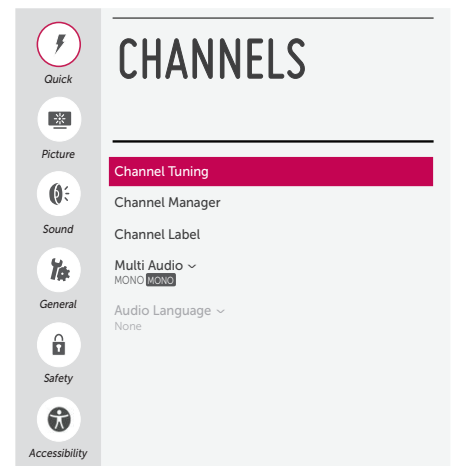

(Optional) Use Channels Menu options to run Auto Tuning and edit the channel lineup.

Channel Banks Overview

Channel Banks enable institution administrators to create tiered channel programming on patient in-room TVs. Each channel bank may offer a custom channel lineup for a pre-determined fee. LY770M TVs are configured with four channel banks, i.e., Channel Banks 1, 2, 3, and 4. The top tier generally contains the most programming (premium, etc.), 2nd tier = lesser programming, 3rd tier = basic programming, etc. It is also possible to create an Inactive TV display with Channel Bank 4, so that an “Inactive TV Call Attendant” message appears when the TV is turned ON. In this case, an administrator can then select another channel bank on the patient’s in-room TV depending on the programming tier requested by the patient.

All channels found during Auto Tuning automatically are added to and active in all four channel banks. See “Channel Status Options” on the following page for information on all available channel status demarcations.

 **Note: Channel banks are only available on TVs that have been configured using the Express Script (i.e., the channel lineup is transferred to the PTC). Channel banks are not supported on TVs that are configured for FTG Mode operation or on TVs in which the channel lineup remains in the CPU.**

 **Note: In the Installer Menu, all available Aux inputs are enabled by default. The Aux inputs will appear between the highest analog and lowest digital channel number in the PTC Channel Map when Channel Up/Down is used on the Installer Remote. If an Aux input will not be used, it is advisable to disable it. In the Express Script, customize the Aux inputs as appropriate in the Enable/Disable Aux Inputs screen (step 2). After the TV setup is transferred to the PTC (as part of the final step of the Express Script), the only way to remove an Aux input from the channel lineup, is to access the Channel Preview/Banks Setup Menu and select “NORMAL-DELETED” as its status.**

Before You Begin

- Channel banks can be defined as part of the Express Script (see pages 23 to 30), if desired. However, if you are setting up channel banks after completing the Express Script, use the Channel Preview/Banks Setup Menu as described below.
- Installer Menu item 028 CH. OVERRIDE must be set to 1 to allow access for channel banks setup. If applicable, make sure to reset item 028 back to 0 when you are finished with channel banks setup.

Accessing the Channel Preview/Banks Setup Menu

1. To select a channel bank, press **CH. BANK** on the Installer Remote. The first time you press the CH. BANK key, the TV display will show the currently active channel bank. Press **CH. BANK** repeatedly until the desired channel bank is selected.
2. After the desired channel bank is selected, press **CH. PREVIEW** on the Installer Remote to display the Channel Preview/Banks Setup Menu (see example at right).

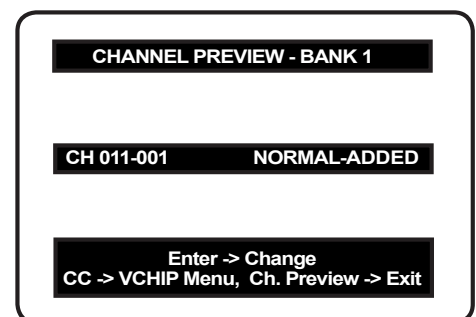

Typical Channel Preview/Banks Setup Menu

Channel Banks Setup (Cont.)

Channel Status Options

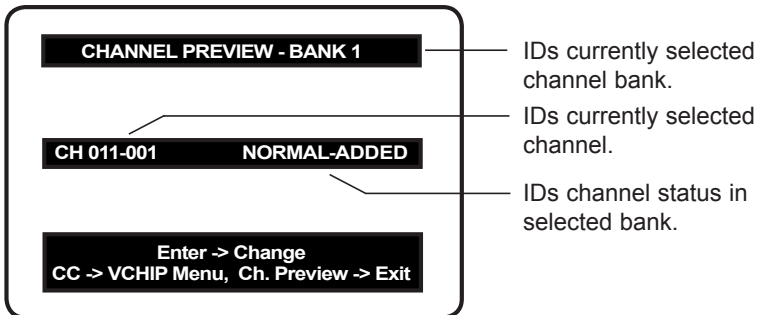

- **NORMAL-ADDED:** The channel will appear in the channel lineup of the currently selected channel bank.
- **NORMAL-DELETED:** The channel will not appear in the channel lineup of the currently selected channel bank.
- **BLANK-ADDED:** The channel will appear in the channel lineup of the currently selected channel bank, with standard audible audio; however, video will be black (no picture). Unless its status is later changed in other banks, the channel status will be BLANK-ADDED in all banks.
- **BLANK-DELETED:** The channel will not appear in the channel lineup of the currently selected channel bank, and in all other channel banks, its channel status will be changed from NORMAL-ADDED to BLANK-ADDED.

Selecting the Channel Status

In the Channel Preview/Banks Setup Menu, use the Channel Up/Down arrows on the Installer Remote to navigate to a channel and the Left/Right arrows to select the channel status.

Adding, Deleting, or Blanking Channels

It is best to complete ADD or DELETE customization before assigning BLANK status. All channels found during Auto Tuning are automatically assigned NORMAL-ADDED status in Channel Banks 1, 2, 3, and 4. The ADDED or DELETED status can be assigned to channels independently in Channel Banks 1, 2, 3, and 4. However, the NORMAL or BLANK status assigned to a channel is for all banks; therefore, a channel blanked, is blanked in all channel banks.

Selecting Deleted Channels

To tune to a NORMAL-DELETED channel:

1. Select a channel bank where the channel's status is NORMAL-ADDED.
2. Navigate to or direct enter the channel number.
3. Select the channel bank where the channel's status is NORMAL-DELETED, and reconfigure the channel status in the Channel Preview/Banks Setup Menu.

Inactive TV Setup

To create an inactive TV display on Channel Bank 4:

1. Press **CH. BANK** on the Installer Remote until Channel Bank 4 is selected, and then press **CH. PREVIEW** to display the Channel Preview/Banks Setup Menu.
2. Press the **SAP** key on the Installer Remote to automatically delete all channels in Channel Bank 4.

When the TV is turned ON by the patient, an "Inactive TV Call Attendant" message will appear on the screen, and after a few moments the TV will turn itself OFF. This will prompt the patient to arrange for an available programming package on Channel Bank 1, 2, or 3. Using the Installer Remote, the administrator can select Channel Bank 1, 2, or 3 depending on the entertainment programming tier selected by the patient. When the patient leaves the hospital, the administrator can then select Channel Bank 4 to reinstate the "Inactive TV" message.

Channel Banks Worksheets

Use Channel Banks Worksheets (see following page) to create channel status charts as part of the setup process. On the channel status charts, show the status for each channel in all channel banks. This then becomes the patient entertainment programming offerings plan.

The following examples show "before-and-after-customization" portions of channel status charts with analog channels, Aux inputs, and digital channels.

Example: Channel Banks After Auto Tuning

BANK	Analog			Aux			Digital													
	2	5	7	AVI	RGB	HDM1	4-1	6-1	13-1	20-5	20-6	30-1	32-1	40-1	40-11	44-1	44-11	45-1	45-11	
1	A	A	A	A	A	A	A	A	A	A	A	A	A	A	A	A	A	A	A	A
2	A	A	A	A	A	A	A	A	A	A	A	A	A	A	A	A	A	A	A	A
3	A	A	A	A	A	A	A	A	A	A	A	A	A	A	A	A	A	A	A	A
4	A	A	A	A	A	A	A	A	A	A	A	A	A	A	A	A	A	A	A	A

A = Active (channel found during Auto Tuning and automatically assigned NORMAL-ADDED status)

Example: Channel Banks After Auto Tuning and Customization with Add/Del/Blank Options

BANK	Analog			Aux			Digital													
	2	5	7	AVI	RGB	HDM1	4-1	6-1	13-1	20-5	20-6	30-1	32-1	40-1	40-11	44-1	44-11	45-1	45-11	
1	BA	A	A	A	A	A	A	A	A	A	A	A	A	A	A	A	A	A	A	A
2	BA	A	A	A	A	A	A	D	D	A	A	A	A	A	A	D	D	D	D	D
3	BD	D	D	A	A	D	A	A	D	D	A	A	A	D	D	D	D	D	D	D
4	BD	D	D	D	D	D	D	D	D	D	D	D	D	D	D	D	D	D	D	D

A = Active channel (channel found during Auto Tuning and retains NORMAL-ADDED status)

D = Deleted channel (channel assigned NORMAL-DELETED status in the Channel Preview/Banks Setup Menu)

BA = Channel assigned BLANK-ADDED status in the Channel Preview/Banks Setup Menu

BD = Channel assigned BLANK-DELETED status in the Channel Preview/Banks Setup Menu

Channel Banks Worksheet

Use this worksheet to plan your program packages. (Photocopy additional worksheets as needed.)

B A N K	Channel Number																			
	1																			
	2																			
	3																			
4																				

B A N K	Channel Number																			
	1																			
	2																			
	3																			
4																				

B A N K	Channel Number																			
	1																			
	2																			
	3																			
4																				

B A N K	Channel Number																			
	1																			
	2																			
	3																			
4																				

B A N K	Channel Number																			
	1																			
	2																			
	3																			
4																				

Date _____ Installer _____ Page ___ of ___
Location _____

Cloning typically refers to the process of capturing a Master TV Setup and transferring it to a Target TV. This section describes how to save (Learn) a Master TV Setup and transfer (Teach) it to a Target TV using a USB memory device / TLX file.

You can also create a TLX file using the FTG File Manager and then use the Teaching procedure to transfer the TLX file to Target TVs. Refer to “Creating an FTG Configuration File” on pages 59 to 60, as necessary.

Learning Configuration from a Master TV

This section describes how to Learn configuration from a Master TV.

Before You Begin

- Ensure the USB device has been formatted with FAT format.
- If the TV is NOT already in FTG Mode via CPU, complete the Custom Master TV Setup procedure (see pages 46 to 48).
- If you would like the Target TV(s) to remain in Pass-through Mode after Teaching, ensure the Master TV does not have an auto-tuned/edited channel lineup; otherwise, Teaching the Learned file will result in the Target TV(s) being configured for FTG Mode via CPU.
- If you intend to use the TV's Zoning feature(s), make sure to assign the appropriate TV Zone # and/or Wi-Fi Zone # as described in Reference section, “Using the TV's Zoning Features,” BEFORE performing the Learning procedure. Also, for Wi-Fi Zoning in particular, the TV's wireless network connection settings should be configured in the IP Environment Menu before Learning is initiated.
- It is not possible to clone a Master TV's clock. Either set a Target TV's clock manually, or use the Auto Clock setting in the TV setup menus.
- Since the Learn From TV (TLX) process retrieves the Channel Map/channel lineup from the CPU, it is not possible to Learn an FTG Channel Map from a TV that is currently in FTG Mode via EBL (Channel Map resides in EBL) or a channel lineup from a TV that was cloned using a clone programmer (channel lineup resides in the PTC).



Caution: Do not unplug the TV power cord or remove the USB memory device while Learning, as doing so may cause the TV to malfunction or harm the USB device, respectively.

Learn Configuration from Master TV

1. Ensure the Master TV is set up completely and turned ON.
2. Insert the USB memory device into the USB port on the Master TV.
3. Press **MENU** on the Installer Remote to display the TV setup menus (TV is in Pass-through Mode) or the Function Menu (TV is already in FTG Mode).
4. Use the arrow navigation keys to select/highlight either the **General** menu icon from the TV setup menus or the **Safety** menu icon from the Function Menu. Then, press the number “7” key a total of seven times to display the TV Manager / USB Download Menu.

Note: The TV Manager / Diagnostics Menu is for service use only.

5. To gain access to the “Learn From TV” option in the TV Manager / USB Download Menu, key in the following number sequence on the Installer Remote: **9-8-7-6**.

(Continued on next page)

Cloning Procedures (Cont.)

(Continued from previous page)

6. Use the Up/Down arrow keys to select **Learn From TV (TLX)**, and then press **OK**.

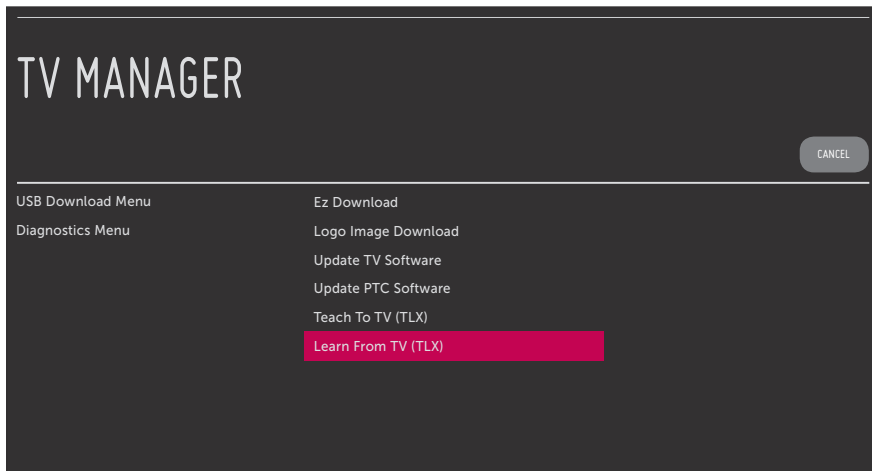

7. In the Learn From TV (TLX) screen:

- If more than one USB memory device is currently connected to the TV, be sure to select the USB device on which you wish to save the TLX file. If necessary, use the Up/Down arrow keys on the Installer Remote to select/highlight the **Select USB Memory Device** field and press **OK**. Then, use the arrow keys to select the appropriate USB device from the drop-down list.
- Next, modify the filename, as required. While the TV model element of the filename may not be changed, you can differentiate this TLX file from others by changing the last five digits of the filename. Use the arrow keys on the Installer Remote to select/highlight either the left (<) or right (>) arrow in the filename field, and press **OK** until the desired number is shown.



8. When you are ready to initiate Learning, use the arrow keys to select **OK** on the screen, and then press **OK** on the Installer Remote.

(Continued on next page)

(Continued from previous page)

Learning status will be shown in a pop-up progress banner at the bottom of the Learn From TV (TLX) screen. This process may take a few minutes. Do NOT remove the USB device until Learning is complete. When the Learning process is complete, a “Saving completed” message is displayed.

9. Press **OK** to return to the Learn From TV (TLX) screen. To return to the TV Manager / USB Download Menu, press **↵** on the Installer Remote or select **BACK** from the Learn From TV (TLX) screen. To return to program viewing, select **CANCEL**.
10. Remove the USB memory device from the Master TV.



Note: If the Master TV has a channel lineup, during Learning, logical channel numbers are automatically assigned in ascending order, starting with 0 (zero), to the physical RF channels of the TV channel lineup to create an FTG Channel Map. See also note below.



Note: If the newly Learned TLX file is to be used for FTG Mode via CPU configuration (i.e., it contains an FTG Channel Map), it is highly recommended that you open the file in the FTG File Manager—BEFORE transferring (Teaching) the file to any Target TVs—to verify FTG Channel Map and FTG Installer Menu settings and enable decryption by marking Pro:Idiom encrypted channels. This will also enable you to confirm channels and add channel attributes, labels, etc.

Teaching Configuration to a Target TV

This section describes how to transfer (Teach) a TLX file from a USB memory device to a TV using the TV Manager / USB Download Menu “Teach To TV (TLX)” option. The TLX file may be created either from a Master TV Setup that was saved (Learned) from a Master TV or in the FTG File Manager.

Before You Begin

- Ensure the USB device has been formatted with FAT format.
- If you have initiated the EZ-Manager Wizard, you can use the wizard’s “USB Configuration” option to access the TV Manager / USB Download Menu and complete the Teaching process, if desired (see “TV Configuration Options” and/or “USB Configuration” on pages 15 and 21, respectively, as necessary).
- You may also use the Ez Download utility to complete the Teaching process. See “Ez Download Utility” on pages 31 to 34 for further information.
- If the Target TV is currently in Pass-through Mode and you intend to use the TV’s Zoning feature(s)—i.e., the TLX file you are Teaching contains an FTG Channel Map and/or FTG profile(s) with TV Zone and/or Wi-Fi Zone assignments—make sure to assign the appropriate TV Zone # and/or Wi-Fi Zone # in the TV when directed to do so in the procedure below. See Reference section, “Using the TV’s Zoning Features,” for further information.
- If you would like the Target TV(s) to remain in Pass-through Mode after Teaching, ensure the TLX file does not contain an FTG Channel Map; otherwise, Teaching will result in the Target TV(s) being configured for FTG Mode via CPU.

(Continued on next page)

Cloning Procedures (Cont.)

(Continued from previous page)

- If the TLX file contains an FTG Channel Map that was Learned from a TV, the physical RF channels in the FTG Channel Map have been assigned logical channel numbers (see “Learning Configuration from a Master TV” above). When you Teach the FTG Channel Map to the Target TV(s), you will have the option to select either logical or physical channel tuning. Even if you select physical channel tuning, the (list of) physical RF channels in the FTG Channel Map will remain in logical order.
- If the TLX file contains an FTG Channel Map that was created in the FTG File Manager, each logical channel number in the FTG Channel Map has been assigned a physical RF channel, an IP channel, or an Aux input (the latter designated by 130-0 through 137-0—see also Reference section, “TV Aux Input Configuration”).

Note: When you Teach the FTG Channel Map to the Target TV(s), depending on the types of channels included in the FTG Channel Map, you may have the option to select either logical or physical channel tuning. If you select physical channel tuning, the physical RF channels and Aux inputs in the FTG Channel Map will remain in logical order.

- If the Target TV EBL is already in FTG Mode, you cannot use this procedure to make changes to the FTG Channel Map and FTG Installer Menu settings. You must use a direct PC-to-TV connection as described in Reference section, “FTG Mode via EBL (Local Configuration),” or an FMA head end device to reconfigure the EBL.
- If the preceding condition applies, but you wish to switch the TV to FTG Mode via CPU, see Reference section, “Restoring Factory Defaults on the TV(s),” for further information before proceeding.
- If the TLX file was created in the FTG File Manager, it may contain multiple zoned FTG Installer Menu profiles for different TV models. Make sure it includes the appropriate Installer Menu profile(s) for the Target TV(s) before Teaching.

 **Caution: Do not unplug the TV power cord or remove the USB memory device while Teaching, as doing so may cause the TV to malfunction or harm the USB device, respectively.**

Teach Configuration to Target TV

1. Turn ON the Target TV.
2. The next step depends on whether the LG Setup Wizard appears on the screen when you turn ON the TV:
 - If the wizard is displayed, you can complete the Teaching process via the EZ-Manager Wizard, as indicated above (see “Before You Begin”). However, to continue with this procedure and access the “Teach to TV (TLX)” option from the TV menus, exit the Setup Wizard. Then, continue with step 3.
 - If the wizard is not displayed, go directly to step 3.

(Continued on next page)

(Continued from previous page)

3. If applicable (see also “Before You Begin” above), make sure to assign the appropriate Zone designation(s) in the Target TV at this time.



Note: In order for the proper location-specific TV Zone and/or Wi-Fi Zone profile data to be applied, the Zone designation(s) must be assigned in the Target TV(s) BEFORE Teaching is performed.

4. Insert the USB memory device with the TLX file into either of the USB ports on the Target TV.
5. Press **MENU** on the Installer Remote to display the TV setup menus (TV is in Pass-through Mode) or the Function Menu (TV is already in FTG Mode via CPU).
6. Use the arrow navigation keys to select/highlight either the **General** menu icon from the TV setup menus or the **Safety** menu icon from the Function Menu. Then, press the number “7” key a total of seven times to display the TV Manager / USB Download Menu.

Note: The TV Manager / Diagnostics Menu is for service use only.

7. With the TV Manager / USB Download Menu on display, use the Up/Down arrow keys to select **Teach To TV (TLX)**, and then press **OK**.

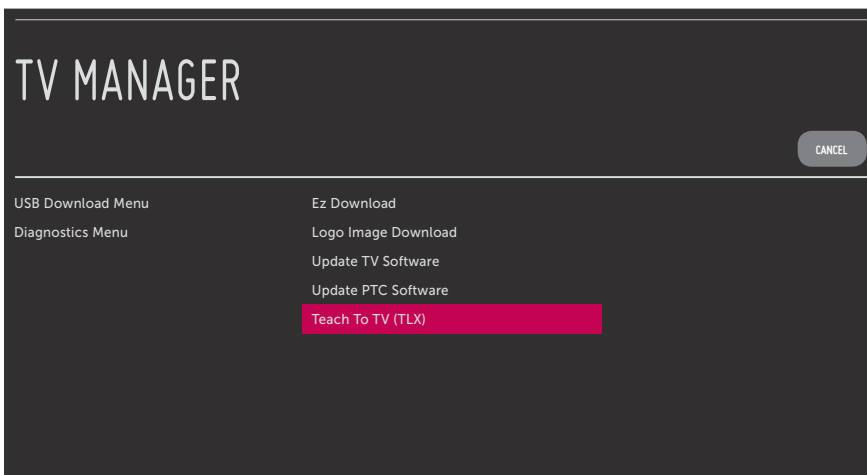

8. In the Teach To TV (TLX) screen:

- If more than one USB memory device is currently connected to the TV, be sure to select the USB device that contains the TLX file you wish to use. If necessary, use the Up/Down arrow keys on the Installer Remote to select/highlight the **Select USB Memory Device** field and press **OK**. Then, use the arrow keys to select the appropriate USB device from the drop-down list.
- Use the arrow keys on the Installer Remote to select/highlight the TLX file you want to install, and then press **OK**. A checkmark will appear at the left of the selected file.

Note: Filenames for TLX files that were Learned from a TV are comprised of the TV model and a five-digit number, for example, xxLY770M-UA00001.TLX.

(Continued on next page)

Cloning Procedures (Cont.)

(Continued from previous page)

- If the TLX file includes an FTG Channel Map with RF channels and Aux inputs *only*, you can choose the format for the channel tuning/banner display. Use the arrows keys to select the desired Channel Tuning / Channel Banner Display option—either Logical or Physical—at the right side of the Teach to TV (TLX) screen. A checkmark will appear at the left of the selected option. Logical tuning is selected by default.

Note: If an FTG Channel Map includes IP channels, only logical tuning is available. Also, if a TLX file does not include an FTG Channel Map, the message, “No Channel Map in TLX file,” will be displayed at the right of the screen.

9. When you are ready to initiate the Teaching process, select **UPDATE** on the screen and then press **OK** on the Installer Remote.

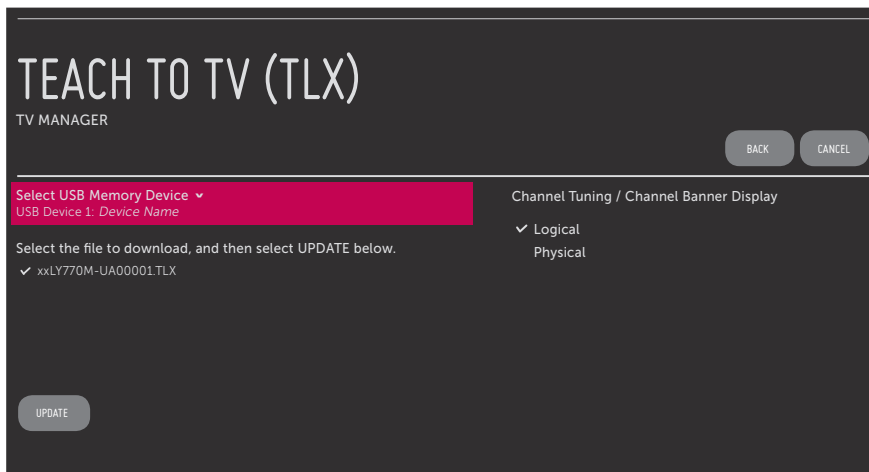

Teaching status will be shown in a pop-up progress banner at the bottom of the Teach To TV (TLX) screen. This process may take a few minutes. Do NOT remove the USB device until Teaching is complete. When the Teaching process is complete, an “Updating completed” message is briefly displayed, and the TV exits the TV Manager / USB Download Menu.

10. Remove the USB memory device from the Target TV, and verify that the appropriate configuration is now resident on the Target TV.

Note: If the Target TV was previously in Pass-through Mode, and the TLX file used for Teaching contained an FTG Channel Map, the Target TV CPU is now in FTG Mode via CPU. After the Teaching process is complete, the TV tunes according to the Start Channel setting in the Installer Menu. If a Start Channel is specified, the TV will tune to that channel, though, in the case of FTG Mode via CPU configuration, a channel banner will only be displayed if the Start Channel is included in the FTG Channel Map (depending on your selection in step 8, the channel banner will display either the Start Channel’s logical channel number or physical RF channel number). Otherwise, the TV will either return to the last channel tuned (TV in Pass-through Mode) or tune to the first channel in the FTG Channel Map (TV in FTG Mode via CPU). If the latter, remember that the channels in the FTG Channel Map are always arranged in logical order, regardless of your selection in step 8.

As indicated in the introduction to this document, there are two separate and distinct methods for configuring LY770M TVs for FTG Mode of operation: one method is to configure the TV CPU for FTG Mode operation, while the other is to configure the TV EBL for FTG Mode operation. FROM A LOCAL CONFIGURATION STANDPOINT, EACH OF THESE METHODS IS MUTUALLY EXCLUSIVE. IF THE CPU IS IN FTG MODE, THE EBL CANNOT BE SWITCHED TO FTG MODE. LIKEWISE, IF THE EBL IS IN FTG MODE, THE CPU CANNOT BE SWITCHED TO FTG MODE.

This section provides an overview of the FTG File Manager, which is used for FTG Mode via CPU configuration. FTG File Manager software is available online at: www.LGolutions.com/ftgsoftware.

Creating an FTG Configuration File

The procedure below describes how to use the FTG File Manager utilities (see sample screens on pages 61 to 64) to create an FTG Configuration (.tlx) file that can be saved to a USB memory device. In order to enable decryption of Pro:Idiom encrypted channels, it is recommended that you create or view/edit an FTG Configuration file using the FTG File Manager.

Note: There is also an option to save (Learn) FTG Configuration from a TV, which may be desirable or required if you want to save customized TV setup menu settings to the FTG Configuration file and/or if you do not know the RF channels at the site. See “Learning Configuration from a Master TV” on pages 53 to 55 for further information.

This procedure provides an overview of the steps required to create an FTG Configuration (.tlx) file. Refer to the **Free-To-Guest (FTG) File Manager User Guide** for further information.

1. Install (if necessary) and launch the FTG File Manager (v1.2.3 or higher) on the PC that will be used to create the FTG Configuration (.tlx) file.
2. You have a number of options:
 - To view and/or base a new FTG Configuration file on an existing FTG Configuration (.tlx) file, click the **Open** button in the TLX File command section of the FTG File Manager main screen, and select/double-click on the desired “.tlx” file.

A list of the file’s contents will be displayed in the TLX File Contents window. Either double-click on an individual item to copy it or click the **Copy All** button directly above the TLX File Contents window to automatically copy all the contents of the opened file to the FTG Configuration List and, if applicable, TV Setup Menu List. Note, though, that while TV setup menu settings can be included in the new FTG Configuration file, the TV setup menu settings are not available for editing.

Edit the configuration of the items in the FTG Configuration List as well as the FTG Configuration List itself and/or the TV Setup Menu List, as necessary, to create a new file. Then, proceed to step 3 when you are ready to continue.
 - To open an existing FTG Configuration (.rml) file created in the FTG Device Configuration Application to use its FTG Channel Map and/or FTG Installer Menu settings, click **File** and then **Open** from the FTG File Manager menu bar, and select/double-click on the desired “.rml” file.

Edit channels and/or settings as necessary. Then, proceed to step 3 when you are ready to continue.
 - Create a new FTG Channel Map using the FTG Channel Map Editor in the FTG Channel Map Configuration Utility. Up to 600 channels (combined total of both RF and IP mapped channels) can be defined in the FTG Channel Map.

When you are ready to continue, click **Configure** and then **FTG File Manager** from the FTG File Manager menu bar to return to the FTG File Manager main screen, and then proceed to step 3.

(Continued on next page)

FTG File Manager Utilities Overview (Cont.)

(Continued from previous page)

Note: To remove an individual item from the FTG Configuration List or the TV Setup Menu List, click on/highlight the item to be removed, and then click the **Remove Item** button directly above the applicable “List” window. To clear both the current FTG Configuration List and TV Setup Menu List contents, click the **Clear** button in the List command section of the FTG File Manager main screen.

Note: To clear the current TLX File Contents, click the **New** button in the TLX File command section of the FTG File Manager main screen (above the TLX File Contents window).

3. To add an FTG Channel Map to the FTG Configuration List, click **>>** under FTG Channel Map. This will copy the current mapped RF and IP channels to the FTG Configuration List.

Note: If you make any change(s) in the FTG Channel Map Configuration Utility to the current data to be included in the FTG Configuration List, you will need to recopy the FTG Channel Map to the FTG Configuration List.

4. (Optional) Load default FTG Installer Menu settings for the TV:

- Click the down arrow at the right of the Chassis field in the Installer Menu Templates section of the FTG File Manager main screen, and select the appropriate chassis from the drop-down list of available models.
- Click the **Load** button.
- Use the FTG Installer Menu Configuration Utility to modify settings, if necessary, including Media Share settings, Wi-Fi Zoning settings, etc. Then, return to the FTG File Manager main screen.

5. If you wish to change the Zone assignment for the current FTG Installer Menu settings, click on the down arrow at the right of the Zone field (below the FTG Installer Menu Settings field), and select the appropriate Zone (0–8).

Note: See Reference section, “Using the TV’s Zoning Features,” for further information on the TV Zoning feature and setting the TV Zone # in the TV(s).

6. To add FTG Installer Menu settings to the FTG Configuration List, click **>>** under FTG Installer Menu Settings. This will copy the selected model settings to the FTG Configuration List.

Note: If you make any change(s) in the FTG Installer Menu Configuration Utility to the current data to be included in the FTG Configuration List, you will need to recopy the FTG Installer Menu settings to the FTG Configuration List.

Note: At the top of both the FTG Configuration List and TV Setup Menu List windows, an Edit Zone field enables you to change the Zone assignment for each LY770M Installer Menu and/or TV Setup Menu profile, if desired. Select/highlight the desired profile, and then click on the down arrow at the right of the applicable Edit Zone field to select the appropriate Zone.

7. Click the **Save** button in the List command section of the FTG File Manager main screen to save the FTG Configuration List and, if present, TV Setup Menu List contents to an FTG Configuration (.tlx) file on the PC’s hard drive for later use.

In the Save As pop-up window, name the file, and click **Save**. The default folder path is C:\Program Files\Zenith\FTG\TLX. Note that the FTG Configuration file will have a “.tlx” file extension.

Note: To remove an individual item from the FTG Configuration List or the TV Setup Menu List before saving the new file, click on/highlight the item to be removed, and then click the **Remove Item** button directly above the applicable window. To clear both the current FTG Configuration List and TV Setup Menu List contents, click the **Clear** button in the List command section of the FTG File Manager main screen.

8. Transfer the FTG Configuration (.tlx) file to a USB memory device, and proceed to “Teaching Configuration to a Target TV” on pages 55 to 58 to transfer the FTG Configuration file to an LY770M TV.

FTG File Manager Utilities Overview

FTG File Manager Main Screen

The FTG File Manager main screen enables you to compile, modify, and save FTG Configuration (.tlx) files. It also allows you to change the Zone assignment for each Installer Menu profile, if desired (see Reference section, "Using the TV's Zoning Features," for further information).

The screenshot shows the FTG File Manager interface with the following callouts:

- FTG CONFIGURATION LIST**: Data to be saved in FTG Configuration (.tlx) file.
- CLEAR/SAVE**: FTG Configuration and TV Setup Menu List options.
- NEW/OPEN**: TLX File options.
- Filename of opened FTG Configuration (.rml) file created using FTG Device Configuration Application.**: Points to the "FTG File:" text box.
- Copy FTG Channel Map to and from FTG Configuration List.**: Points to the "FTG Channel Map" section.
- Copy FTG Installer Menu settings to and from FTG Configuration List. Assign Zone as applicable.**: Points to the "FTG Installer Menu Settings" section.
- Load default FTG Installer Menu for LY770M chassis.**: Points to the "Installer Menu Templates" section.
- TV SETUP MENU LIST**: Data to be saved in FTG Configuration file.
- TLX FILE CONTENTS**: Data contained in opened FTG Configuration (.tlx) file.



Note: The data referenced in the FTG Configuration List is only a snapshot of the current FTG Channel Map and FTG Installer Menu settings when copied to the list. If you make any change(s) to the current data to be included in the FTG Configuration List, you will need to recopy Channel Map and Installer Menu settings to the FTG Configuration List.

FTG File Manager Utilities Overview (Cont.)

FTG Channel Map Editor

The FTG Channel Map Editor shows a single Logical Channel's data and the FTG Channel Map.

LOGICAL CHANNEL MAPPING

Select a Logical Channel number. Then, assign the RF, Major, and Minor channel numbers to complete the mapping.

CUSTOM CHANNEL LABELS/ICONS

Enter custom labels and select icons by name on menu or by number.

SET CHANNEL ATTRIBUTES

Check/select Encrypted, OSD, or Blank Video.

Logical	RF	Major	Minor	Label	ICON	Attribute	Restricted
2	2	2	0	WBBM-TV	14 - CBS	0	
5	5	5	0	WMAQ-TV	15 - NBC	0	
7	7	7	0	WLS-TV	13 - ABC	0	
9	9	9	0	WGN-TV	89 - WGN	0	
11	11	11	0	WTTW	17 - PBS	0	
14	31	31	3	FOX	16 - FOX	0	
15	19	19	3	WGN	89 - WGN	0	
16	47	47	4	KIDS	133 - PBS Kids	0	
17	27	27	3	THE U	174 - UPN	0	
40	65	65	1	HBO-HD	12 - HBO	EO	
41	65	65	11	ESPN-HD	2 - ESPN	EO	
42	67	67	1	ESPN2HD	21 - ESPN2	EO	

ZONE RESTRICTION

Set Zone restriction(s) per channel. See Reference section, "Using the TV's Zoning Features," for further information.

ADD

After defining a new Logical Channel, click to add channel to the FTG Channel Map.

EXIT

Click to exit editor and return to FTG Channel Map Configuration Utility.

UPDATE

After editing an existing Logical Channel's data, click to commit the changes in the FTG Channel Map.

DELETE

Click to remove highlighted channel from FTG Channel Map.

FTG File Manager Utilities Overview (Cont.)

FTG Installer Menu Configuration Utility

CONFIGURATION SETTINGS

Select tabs for categories of Installer Menu items to set up TV.

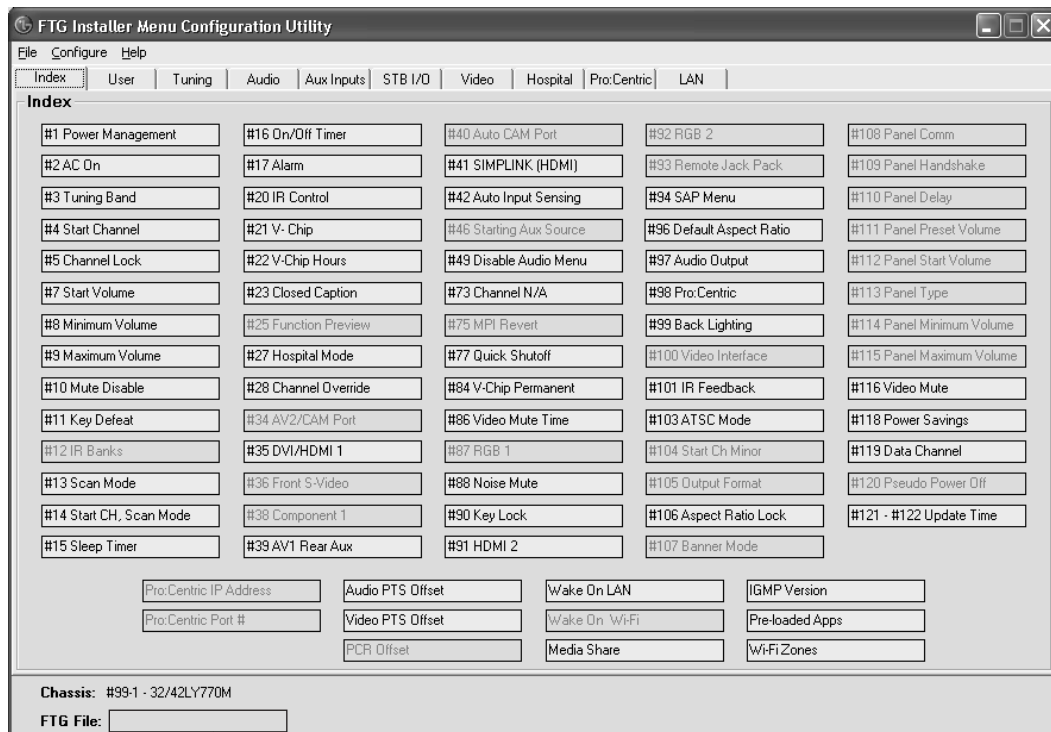

Filename of opened FTG Configuration (.rml) file created using FTG Device Configuration Application.

Note: The Pro:Centric tab enables you to set up Pro:Centric-specific parameters. The LAN tab enables you to set up a variety of LAN features, including the Wi-Fi Zoning feature. Refer to the *Free-To-Guest (FTG) File Manager User Guide* for further information. Also, see Reference section, "Using the TV's Zoning Features," for additional information on Wi-Fi Zoning.

The IP Environment Menu enables you to set up the network features of the TV. If you intend to create a Master TV Setup for cloning purposes (see Master TV Setup procedure on pages 46 to 48), all IP Environment settings, with the exception of Wired Network Connection settings and the TV name (editable in the Media Share Menu), may be cloned.

Note: With the exception of Network Setting configuration, the IP Environment settings are editable (with the Installer Remote) only if the TV is in Pass-through Mode and read-only when the TV is not in Pass-through Mode.

Accessing the IP Environment Menu

Note: When you enter the IP Environment Menu, the Installer Menu is exited (all current settings are saved automatically upon exit). If you are also in the process of updating Installer Menu items, you may wish to set all items as needed before you access the IP Environment Menu. Otherwise, after exiting the IP Environment Menu, you will need to reaccess the Installer Menu to set additional items.

1. Use the Installer Remote to access the Installer Menu (see “Accessing the Installer Menu” on page 35 for further information).
2. Navigate to Installer Menu item 119 DATA CHANNEL, and press **2-5-3 + MENU** to launch the IP Environment Menu.

Use the Up/Down arrow keys on the Installer Remote to select the desired menu option and then press **OK**. Refer to the following sections for information on each of the IP Environment setup options.

When you have completed your IP Environment configuration as required, press **EXIT** or **↵** on the Installer Remote to exit the IP Environment Menu.

Pro:Centric Setup

Pro:Centric options enable you to configure the TV with the appropriate settings to connect to the Pro:Centric server. Use the Up/Down arrow keys on the Installer Remote to navigate between fields.

1. With the IP Environment Menu on display, use the arrow keys on the Installer Remote to select the **Pro:Centric** menu option. Then, press **OK**.
2. Refer to the appropriate subsection(s) below to configure the TV's Pro:Centric settings to match those of the Pro:Centric server.

While the Pro:Centric application (Mode) itself is an additional feature, the appropriate Pro:Centric server configuration must be completed to enable TV E-Z Installation (splash screen, configuration, and software/firmware) data downloads and, if configured, the Pro:Centric application download.

Note: By default, the Pro:Centric Menu initially shows RF configuration fields. When you select “IP” as the Media Type, the Data Channel field is replaced with IP Address and Port Number fields.

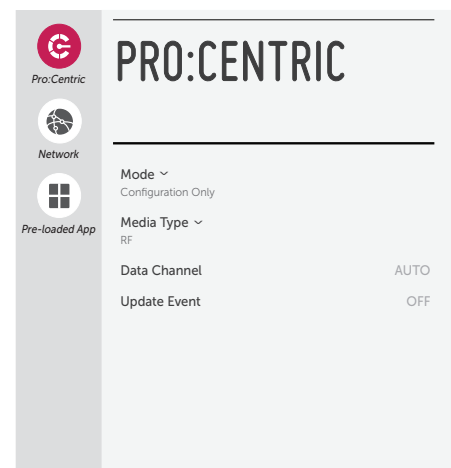

(Continued on next page)

IP Environment Setup (Cont.)

(Continued from previous page)

RF Configuration

- a) Select/highlight the **Media Type** field and press **OK** on the Installer Remote to display the drop-down list of options. Then, use the Up/Down arrow keys to select **RF**.

Note: If the Media Type has already been set in the EZ-Manager Wizard, the specified value will be reflected in this field.

- b) For TVs in Pass-through Mode or FTG Mode via CPU, if the Data Channel is left at its default value (AUTO), the TV's Data Channel Auto Search feature will be enabled. See Installer Menu item 119 DATA CHANNEL description on page 44 for further information.

To toggle between AUTO or MANUAL settings for the Data Channel, select/highlight the **Data Channel** field and press **OK**.

When the Data Channel field is set to "MANUAL," a data entry field is available on the screen, and you can specify the RF channel number that will be used by the Pro:Centric server as its data channel. The Data Channel value can be set from 0 (disabled) to 135.* Use the arrow keys on the Installer Remote to select the Data Channel data entry field and press **OK**. You can then use the number keys on the Installer Remote to direct enter the Data Channel, or you can use the arrow keys to select the appropriate number(s) from the pop-up virtual keyboard displayed at the bottom of the screen. When you are done, select **Enter** from the virtual keyboard, and then press **OK** on the Installer Remote.

Note: If the Data Channel has already been set in the Installer Menu (Installer Menu item 119) or in the EZ-Manager Wizard, the specified channel will appear in the Data Channel data entry field. If you change the Data Channel in this menu, Installer Menu item 119 will now show the value you entered here.

IP Configuration

- a) Select/highlight the **Media Type** field and press **OK** on the Installer Remote to display the drop-down list of options. Then, use the Up/Down arrow keys to select **IP**. IP Address and Port Number fields will appear on the screen (in place of the Data Channel field).

Note: If the Media Type has already been set in the EZ-Manager Wizard, the specified value will be reflected in this field. Also, if the server IP address and port number have already been set in the EZ-Manager Wizard, the specified data will be reflected in the IP Address and Port Number fields.

Note: Setting the Media Type to "IP" automatically sets item 119 DATA CHANNEL in the Installer Menu to 253. You cannot alter this setting unless you revert Media Type to "RF." Also, it is not possible to direct enter "253" in the Installer Menu.

- b) Enter the Pro:Centric server IP address and port number in the IP Address and Port Number fields, respectively. The IP address must match the IPv4 multicast address and the port number must match the port number that is set in the Pro:Centric server.

For each data entry field: Use the arrow keys to select the field and press **OK**. Then, you can either use the number keys on the Installer Remote to direct enter data values or use the arrow keys to select the appropriate number(s) from the pop-up virtual keyboard displayed at the bottom of the screen. When you are done, select **Enter** from the virtual keyboard, and then press **OK** on the Installer Remote.

(Continued on next page)

* PCS150R and later Pro:Centric servers do not support HRC or IRC cable channel frequencies.

(Continued from previous page)

Pro:Centric Application Mode Configuration

Select/highlight the **Mode** field and press **OK** on the Installer Remote to display the drop-down list of options. Then, use the Up/Down arrow keys to select the appropriate Pro:Centric Application Mode setting—**Configuration Only**, **FLASH**, **GEM**, or **HTML**. If the Pro:Centric Application Mode is set to “Configuration Only,” Pro:Centric application data will not be downloaded.

Note: If the mode has already been set in the Installer Menu (item 098 PRO:CENTRIC) or in the EZ-Manager Wizard, the specified mode will be reflected in this field. If you change the mode in this menu, Installer Menu item 098 will now reflect the value you selected here.

3. Select/specify the appropriate Update Event setting(s), as required. Based on Update Time settings, the Wake For Update feature wakes the TV once daily to check for, and if applicable, download updates from the Pro:Centric server. See Installer Menu item 121 UPDATE TIME HR description on page 45 for additional information on Wake For Update functionality.
 - To toggle between ON and OFF in this menu, select/highlight the **Update Event** field and press **OK** on the Installer Remote. When Update Event is set to “ON,” an Update Time field is displayed on the screen.
 - If Update Event is ON, set the Update Time as required. Use the arrow keys on the Installer Remote to select/highlight the Update Time field, and then press **OK**. Hour, Minute, and Meridiem fields will be displayed. Select each field in turn and specify the appropriate Wake For Update time, as desired. Note that the Update Time set in this menu is based on a 12-hour clock. Ensure the meridiem (AM/PM) specification is set accordingly.
4. Once all fields are completed as required, use the arrow keys on the Installer Remote to return to the IP Environment Menu, as necessary, or press **↵** to exit the IP Environment Menu.

Network Configuration

This section describes each of the options available in the Network Menu (see example at right). Refer to the appropriate section(s) on the following pages.

 **Note:** If you intend to use the Wi-Fi Zoning feature with cloning configuration, you must configure the wireless network connection as part of the Master TV Setup. See “Configuring a Wi-Fi Network Connection” on page 69 for further information.

Accessing the Network Menu

With the IP Environment Menu on display, use the arrow keys on the Installer Remote to select the **Network** menu option. Then, press **OK**.

Note: The TV’s MAC address is displayed at the top of the Network Menu screen and cannot be modified.

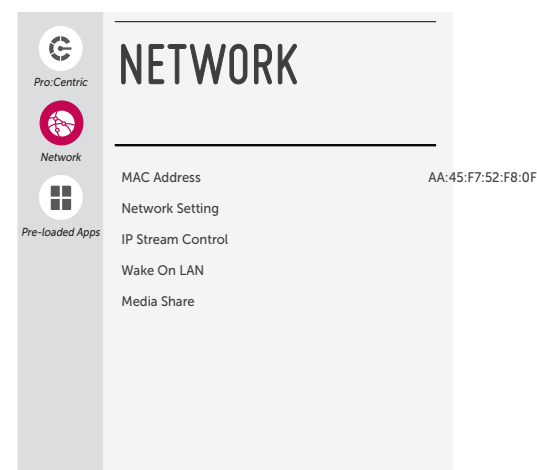

IP Environment Setup (Cont.)

Configuring a Wired Network Connection

Note: If desired, you can configure both wired and wireless connections. However, note that a wired connection is always prioritized over a wireless connection. That is, when the TV is turned OFF and then back ON, if a LAN cable is detected between the TV and the network, the TV will default to the wired connection. If the LAN cable is removed, the TV will then attempt to establish the wireless connection. Whenever the LAN cable is reconnected, the TV will re-establish the wired connection.

1. Connect the appropriate cable between the TV and the network.
2. With the Network Menu on display, use the arrow keys on the Installer Remote to select **Network Setting**. Then, press **OK**. A second Network screen (see example at right), with Wired and Wi-Fi Connection setup options, will be displayed.

By default, the TV uses DHCP, and if a LAN cable is detected, the TV will attempt to connect to the network as soon as you select "Network Setting" above. If the TV is able to connect to the network, a "Connected to Internet" message will be displayed below the Wired Connection field.

3. If the network is not configured for DHCP or you want to specify static configuration data or you would like to change the network configuration from Manual to Automatic, edit the IP configuration for this TV as follows:
 - In the second Network screen, select **Wired Connection** and press **OK**. Then, in the Wired screen, select **Edit** (if not already selected) and press **OK**.
 - In the Edit IP screen, select or de-select the "Set Automatically" checkbox, as required. A checkmark indicates that Automatic configuration is enabled.
 - To manually edit the IP configuration, for each data entry field: Use the arrow keys on the Installer Remote to select the field and press **OK**. You can use the number keys on the Installer Remote to direct enter numeric values or use the arrow keys to select the appropriate numbers from the pop-up virtual keyboard displayed at the bottom of the screen. (Note, however, that you must use the dot "." key from the virtual keyboard to separate each octet of an IP address.) When you are done, select **Enter** from the virtual keyboard, and then press **OK** on the Installer Remote.
 - When all Edit IP fields are set as required, use the arrow keys on the Installer Remote to select **Connect** and press **OK**.

At the top of the screen, you will see a progress display that indicates status as each network element is confirmed (see example at right).

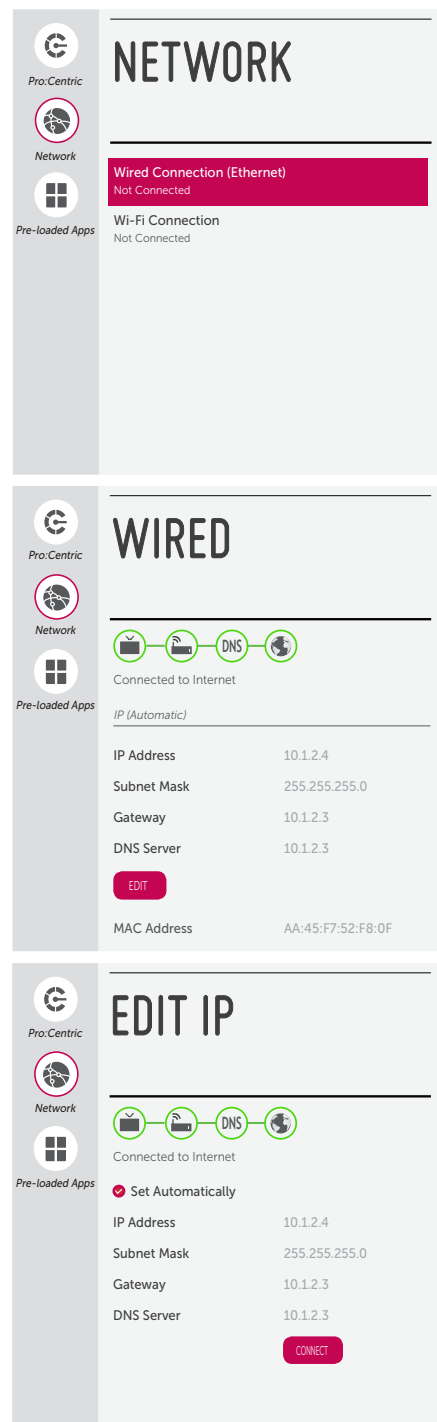

(Continued on next page)

(Continued from previous page)

If the network is connected successfully, a “Connected to Internet” message will appear just below the progress display. If the network connection is not successful, the progress display will identify the network element in which the connection failed. Check your cabling and/or verify the configuration data, as necessary.

4. Once the wired network configuration is complete, use the arrow keys on the Installer Remote to return to the IP Environment Menu, as necessary, or press ↵ to return to the previous Network Menu level(s) and/or exit the IP Environment Menu.

Configuring a Wi-Fi Network Connection

1. With the Network Menu on display, use the arrow keys on the Installer Remote to select **Network Setting**. Then, press **OK**.
2. A second Network screen (see example at right), with Wired and Wi-Fi Connection setup options, will be displayed. Select **Wi-Fi Connection** and press **OK**.
3. In the Wi-Fi screen, available access points are listed in the top half, while additional menu options are listed in the bottom half, of the screen. Use the arrow keys on the Installer Remote to select the desired access point, or select the type of wireless connection to configure (see descriptions below). Then, press **OK**.
 - Add a hidden wireless network: Direct enter the SSID of an access point whose SSID has not been enabled for broadcast (i.e., the access point does not appear in the list of access points).
 - WPS PBC: Connect to a network via an access point that is enabled for PBC.
 - WPS PIN: Complete network/PIN verification via the access point web interface.

Make sure you have the network security password/PIN available if you are attempting to connect to a secured network.

4. Follow the on-screen instructions to complete the appropriate network configuration. Use the Installer Remote to navigate between fields and make entries, etc.

Note: As with a wired connection, you will have the option to specify the IP configuration for this network connection. Once the initial connection is established, you can select **Advanced Settings** (initially greyed out) at the bottom of the Wi-Fi screen to view the IP configuration data. In the Advanced screen, select **Edit** and press **OK**, and then modify the IP data, as required. See step 3 of the wired connection procedure above for further information on the Edit IP screen fields.

5. Once the wireless network configuration is complete, use the arrow keys on the Installer Remote to return to the IP Environment Menu, as necessary, or press ↵ to return to the previous Network Menu level(s) and/or exit the IP Environment Menu.

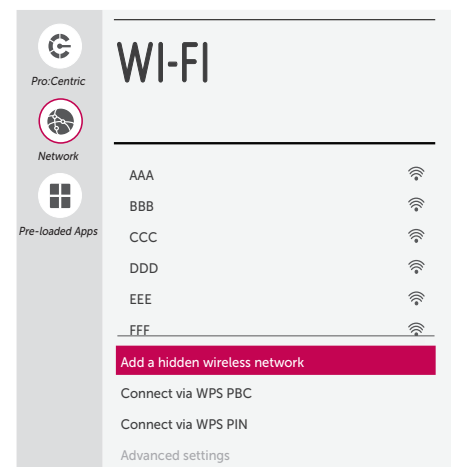
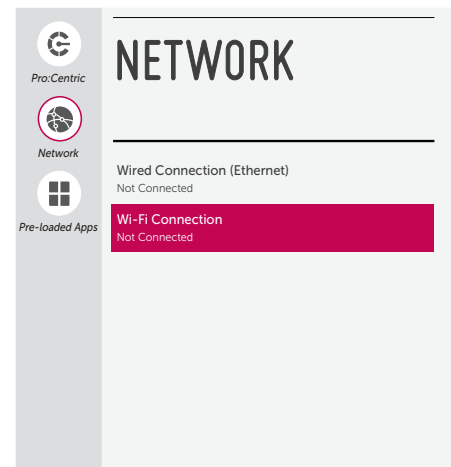

IP Environment Setup (Cont.)

IP Stream Control

If necessary, due to an audio and/or video stream delay, IP Stream Control options enable you to compensate for synchronization irregularities by allowing audio PTS and video PTS offset modifications. This menu also enables you to specify the IGMP version (2 or 3). Note that any modifications to these settings should be performed by qualified personnel only.

1. With the Network Menu on display, use the arrow keys on the Installer Remote to select **IP Stream Control**. Then, press **OK**.
2. In the IP Stream Control screen, use the Up/Down arrow keys on the Installer Remote to select/highlight the appropriate field—Audio PTS Offset, Video PTS Offset, or IGMP Version—and then press **OK**.
3. If you are modifying an offset value, use the Left/Right arrow keys to select the appropriate value for the selected field. Offset values represent offset time in milliseconds (ms) and can be adjusted from -500 ms to +500 ms in 10 ms increments. When you are done, press **OK** on the Installer Remote.

If you are modifying the IGMP version, use the Up/Down arrow keys to select the appropriate version number and press **OK**.

4. Once all modifications are completed as required, use the arrow keys on the Installer Remote to return to the IP Environment Menu, as necessary, or press ↵ to return to the Network Menu and/or exit the IP Environment Menu.

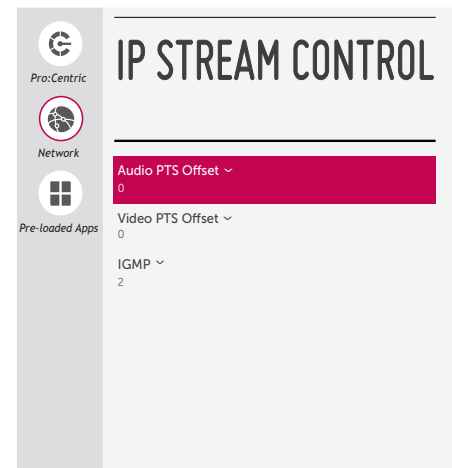

Wake On LAN Setup

The Wake On LAN feature enables the TV to receive software updates and/or be powered ON upon receipt of Wake Up Frame packets and/or Magic Packet data via the wired LAN. To facilitate use of this feature, note that the appropriate wired connection must be made. This menu option enables you to specify Wake On LAN parameters.

1. With the Network Menu on display, use the arrow keys on the Installer Remote to select **Wake On LAN**. Then, press **OK**.
2. In the Wake On LAN screen, use the Up/Down arrow keys on the Installer Remote to select/highlight the desired field and press **OK**. Then, use the arrow keys to select the desired setting—Disabled, Update, or Power On—from the drop-down list of options.
3. Once all fields are completed as required, use the arrow keys on the Installer Remote to return to the IP Environment Menu, as necessary, or press ↵ to return to the Network Menu and/or exit the IP Environment Menu.

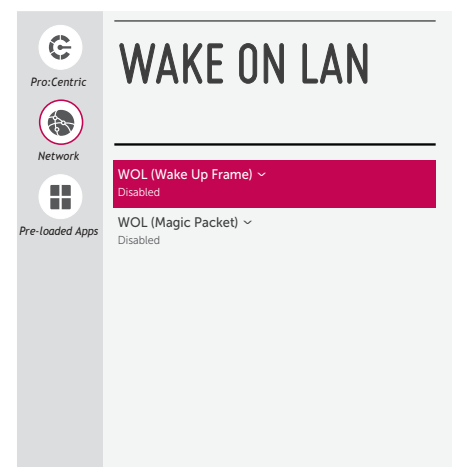

Media Share Setup

Media Share allows you to enable Smart Share[®], Screen Share, and DMR options on this TV.

- The LG Smart Share feature allows guests to use the TV to access and view data shared either by wired DLNA Certified[®] devices connected to the same LAN as the TV or by wireless LG devices using LG's Smart Share application with Wi-Fi Direct[®].
- Screen Share enables screen sharing with a Miracast[®] or Wireless Display (WiDi) capable device (e.g., a laptop with Intel[®] hardware).
- DMR enables the TV to act as a Digital Media Renderer (DMR) device to receive content from DLNA Certified devices on the same network.

Note: See also Reference section, "Using Media Share Features," for additional information

1. With the Network Menu on display, use the arrow keys on the Installer Remote to select **Media Share**. Then, press **OK**.
2. In the Media Share screen, the Smart Share, Screen Share, and DMR features may be toggled from DISABLE to ENABLE and vice versa as follows: Use the Up/Down arrow keys on the Installer Remote to select/highlight the desired feature, and then press **OK**.
3. If desired, you can specify a name for this TV so that it is easy to identify and differentiate from other TVs for which sharing has been enabled.

To edit the TV name, use the Up/Down arrow keys to select the **TV Name** field, and then press **OK**. You can then use the number keys on the Installer Remote to direct enter a numeric TV name, or you can use the arrow keys to select the appropriate alphanumeric character(s) from the pop-up virtual keyboard at the bottom of the screen. When you are done, select **Enter** from the virtual keyboard, and then press **OK** on the Installer Remote.

Note: The default name of each LY770M TV is its serial number. While Smart Share, Screen Share, and DMR settings are clonable, the TV name cannot be cloned.

4. Once all fields are completed as required, use the arrow keys on the Installer Remote to return to the IP Environment Menu, as necessary, or press **↵** to return to the Network Menu and/or exit the IP Environment Menu.

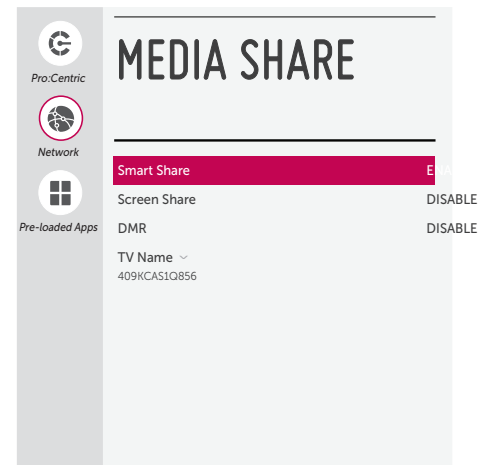

IP Environment Setup (Cont.)

Pre-loaded Applications

This option allows you to select which of the pre-loaded application icons to display in the TV's Smart Launcher, which appears along the bottom of the screen.

When the Pro:Centric application is disabled, the Smart Launcher is available to end users via the PORTAL button on the remote control. Depending on the remote control being used, the Smart Launcher may also be available to end users via a SMART button.

1. With the IP Environment Menu on display, use the arrow keys on the Installer Remote to select **Pre-loaded Apps**. Then, press **OK**.
2. In the Pre-loaded Apps screen, a list of available application options is displayed. Use the Up/Down arrow keys to highlight each application you wish to select or de-select, and press **OK** on the Installer Remote. When an application is selected, a checkmark is displayed at the left of the application name.

Note: Though not included in the application list on this screen, all Screen Share applications are available in the Smart Launcher once they are enabled in the Media Share screen. See "Media Share Setup" on the previous page.

3. When you are done selecting the pre-loaded application icons to be displayed in the Smart Launcher, as required, use the arrow keys on the Installer Remote to return to the IP Environment Menu, as necessary, or press **↵** to exit the IP Environment Menu.

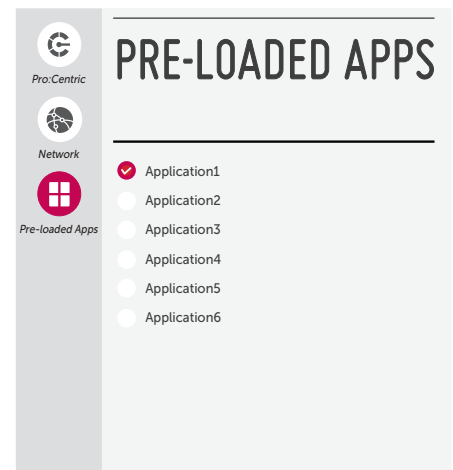

Reference: Updating TV/PTC Software using a USB Memory Device

This section describes how to update TV (CPU) and/or PTC software using the TV Manager / USB Download Menu “Update TV Software” and/or “Update PTC Software” option(s), respectively, though you may also use the Ez Download utility to update software, if desired. See “Ez Download Utility” on pages 31 to 34 for further information.

Before You Begin

- Software update files must be stored in a folder named “LG_DTV” in the root directory of the USB memory device.
- Ensure the USB device has been formatted with FAT format.

Update the TV/PTC Software

Note: You can check the TV/PTC software versions by accessing the Installer Menu with the Installer Remote. See “Accessing the Installer Menu” on page 35 for further information. PTC and CPU versions are displayed in the Installer Menu footer.

Note for TV CPU Software Update only: If the TV detects a software file on the USB device, it will automatically display an Update TV Software screen, and if the file contains a later version of software than is currently running on the TV, you can start the software update from this screen (select **UPDATE** and press **OK**). Otherwise, you can exit the screen (select **CANCEL** and press **OK**), and access the TV Manager / USB Download Menu as described below.

1. Turn ON the TV, and then insert the USB memory device into either of the USB ports on the TV.
2. Press **MENU** on the Installer Remote to display the TV setup menus (TV is in Pass-through Mode) or the Function Menu (TV is not in Pass-through Mode).
3. Use the arrow navigation keys to select/highlight either the **General** menu icon from the TV setup menus or the **Safety** menu icon from the Function Menu. Then, press the number “7” key a total of seven times to display the TV Manager / USB Download Menu.
4. With the TV Manager / USB Download Menu on display, use the Up/Down arrow keys to select **Update TV Software** or **Update PTC Software**, as applicable, and press **OK**.

Note: The TV Manager / Diagnostics Menu is for service use only.

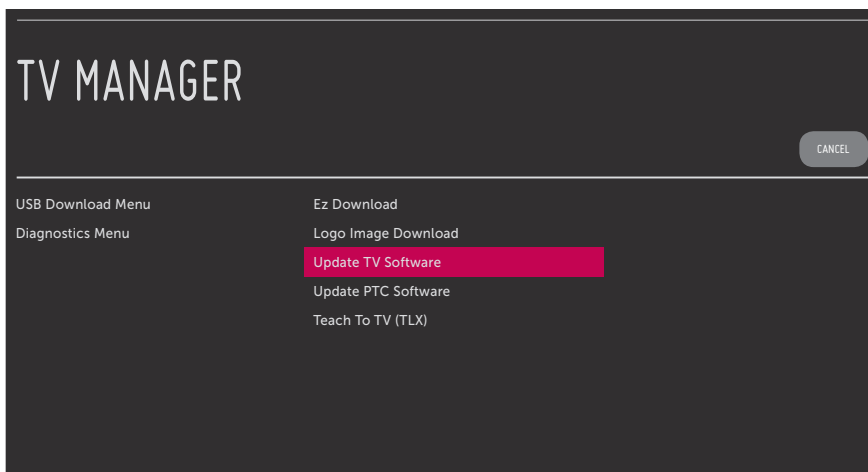

(Continued on next page)

Reference: Updating TV/PTC Software using a USB Memory Device (Cont.)

(Continued from previous page)

5. In the next screen (Update TV Software or Update PTC Software depending on your selection in step 4):

- If more than one USB memory device is currently connected to the TV, be sure to select the USB device that contains the software file you wish to use. If necessary, use the Up/Down arrow keys on the Installer Remote to select/highlight the **Select USB Memory Device** field and press **OK**. Then, use the arrow keys to select the appropriate USB device from the drop-down list.
- Use the Up/Down arrow keys to select/highlight the update file to download, and then press **OK**. A checkmark will appear at the left of the selected file.
- When you are ready to download the update, select **UPDATE** on the screen, and then press **OK** on the Installer Remote

Note: The following screen sample illustrates an Update TV Software screen.

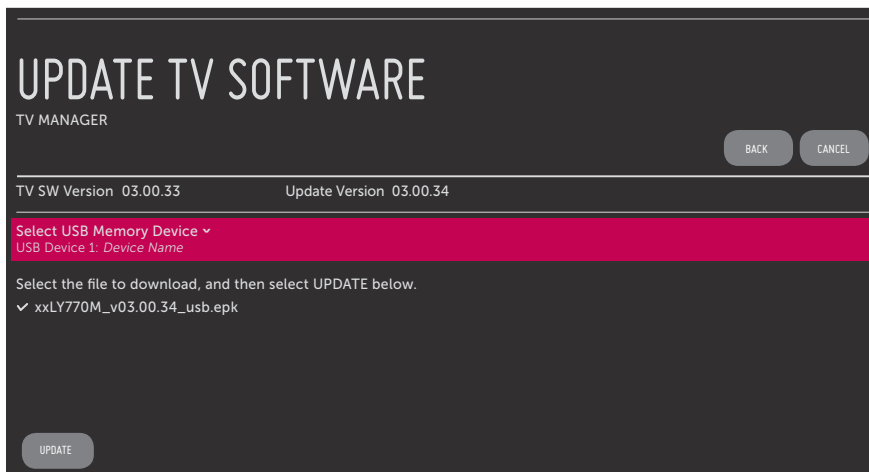

TV software update progress is shown in a new Update TV Software screen, while PTC software update progress is shown in a pop-up banner at the bottom of the Update PTC Software screen. Do NOT remove the USB device until the software update is complete. When the software update is complete, the TV will automatically reboot.

Reference: Downloading a Splash Screen Image using a USB Memory Device

This section describes how to download a splash screen image using the TV Manager / USB Download Menu “Logo Image Download” option, though you may also use the Ez Download utility to download the splash image, if desired. See “Ez Download Utility” on pages 31 to 34 for further information.

Splash Screen Image File Guidelines

- The splash screen image may be either a baseline or progressive JPEG or a 24-bit (RGB 8x8x8) BMP.
- A JPEG image should be no larger than 6 MB.
- A BMP image should be no larger than 5.93 MB.
- The maximum resolution allowed for the splash screen image is 1920 x 1080 pixels (FHD).
- Avoid using special characters, such as ?, -, etc., in the splash screen image file name.

Before You Begin

- The splash screen image file must be stored in a folder named “LG_DTV” in the root directory of the USB memory device.
- Ensure the USB device has been formatted with FAT format.

Download the Splash Screen Image

1. Turn ON the TV, and then insert the USB memory device into either of the USB ports on the TV.
2. Press **MENU** on the Installer Remote to display the TV setup menus (TV is in Pass-through Mode) or the Function Menu (TV is not in Pass-through Mode).
3. Use the arrow navigation keys to select/highlight either the **General** menu icon from the TV setup menus or the **Safety** menu icon from the Function Menu. Then, press the number “7” key a total of seven times to display the TV Manager / USB Download Menu.
4. With the TV Manager / USB Download Menu on display, use the Up/Down arrow keys to select **Logo Image Download**, and then press **OK**.

Note: The TV Manager / Diagnostics Menu is for service use only.

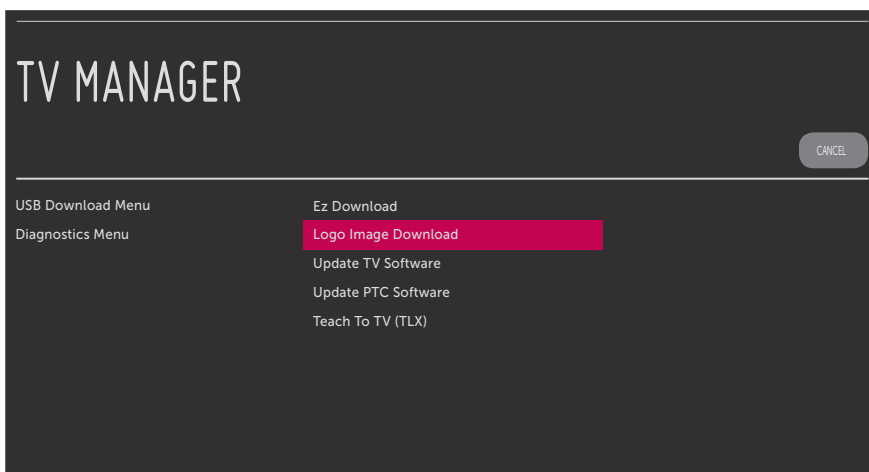

(Continued on next page)

Reference: Downloading a Splash Screen Image using a USB Memory Device (Cont.)

(Continued from previous page)

5. In the Logo Image Download screen:

- If more than one USB memory device is currently connected to the TV, be sure to select the USB device that contains the image file you wish to use. If necessary, use the Up/Down arrow keys on the Installer Remote to select/highlight the **Select USB Memory Device** field and press **OK**. Then, use the arrow keys to select the appropriate USB device from the drop-down list.
- Use the Up/Down arrow keys to select/highlight the image file to download, and then press **OK**. A checkmark will appear at the left of the selected file.
- When you are ready to download the image file, select **UPDATE** on the screen, and then press **OK** on the Installer Remote.

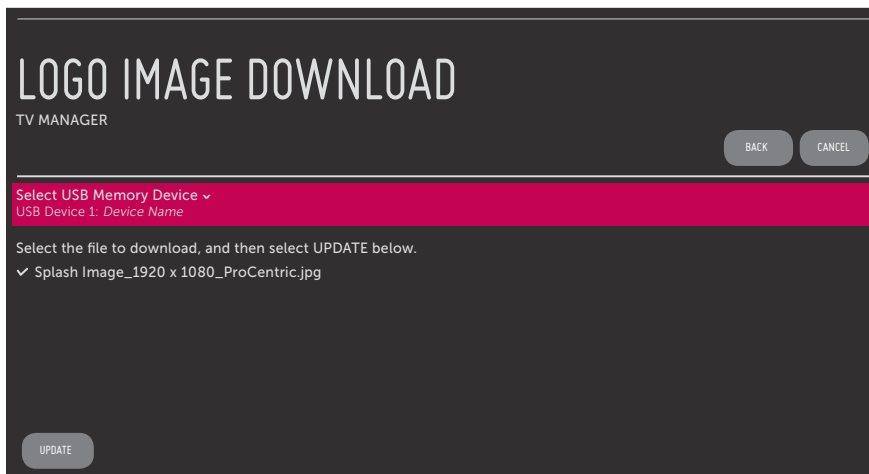

The TV will show update progress in a pop-up banner at the bottom of the screen. Do NOT remove the USB device until the splash screen image update is complete. When the image update is complete, the TV will automatically reboot. During the reboot, you should see the new splash screen.

Reference: Power Consumption Settings

The following tables assume that Installer Menu item 118 POWER SAVINGS is set to 3 (default) and Installer Menu item 099 BACK LIGHTING is set as shown below (default value is 255).

Item 099 Back Lighting (Static)	32LY770M		42LY770M	
	Power Consumption (Watts)	Percent Savings	Power Consumption (Watts)	Percent Savings
100	50.4	0.0%	64.4	0.0%
90	47.9	5.0%	60.8	5.6%
80	46.0	8.7%	57.8	10.2%
70	43.8	13.1%	54.3	15.7%
60	41.4	17.9%	50.6	21.4%
50	39.2	22.2%	47.1	26.9%
40	37.2	26.2%	44.1	31.5%
30	35.0	30.6%	40.6	37.0%
20	33.1	34.3%	37.5	41.8%
10	30.8	38.9%	33.9	47.4%
1	28.9	42.7%	30.7	52.3%

Item 099 Back Lighting (Dynamic)	32LY770M		42LY770M	
	Power Consumption (Watts)	Percent Savings	Power Consumption (Watts)	Percent Savings
200	50.2	0.0%	65.0	0.0%
190	47.9	4.6%	61.3	5.7%
180	46.0	8.4%	58.2	10.5%
170	43.8	12.7%	54.6	16.0%
160	41.4	17.5%	50.9	21.7%
150	39.2	21.9%	47.4	27.1%
140	37.3	25.7%	44.3	31.8%
130	35.0	30.3%	40.8	37.2%
120	33.0	34.3%	37.7	42.0%
110	30.8	38.6%	34.0	47.7%
101	28.8	42.6%	30.8	52.6%

Note: Values are results of controlled experiments under laboratory conditions.

Reference: TV Aux Input Configuration

DIRECT ACCESS Tuning *		TV		ENABLE					MPI DATA				Installer Menu Item 046 START AUX SRCE (Start Aux Source) Value
				Installer Menu			MPI DATA STATUS TYPE 0x41 SOURCES ENABLED (R/W)		DATA STATUS TYPE 0xD2 CURRENT AV SOURCE (R)		DATA STATUS TYPE 0x0D AUX SOURCE (R)		
Installer Menu Item 029 OLD OCV = 0	Installer Menu Item 029 OLD OCV = 1	Aux Input	Input Mode	Item	Function	Value	Enable Bit	Label	Value	Value	Description		
131-0	91-0	Video1 (Rear)	CV	39	REAR AUX EN	1	1	Rear Video (Aux)	1	0	VIDEO	1	
132-0	92-0	HDMI2	DTV	91	HDMI2 ENABLE	1	2	S-Video Rear	2	0	VIDEO	5	
			PC			2				2	COMPUTER		
133-0	93-0	HDMI1/ DVI	DTV	35	HDMI1 ENABLE	1	3	Front Computer	3	0	VIDEO	3	
			PC			2				2	COMPUTER		

* Use Installer Remote to enter channel number indicated based on OLD OCV Installer Menu setting.

Reference: *b*-LAN Setup & Overview

The *b*-LAN module is internal to the TV. It allows hotel/institution head end equipment with *b*-LAN technology to communicate, via the institution's RF distribution system, with the TV for configuration and control.

Installer Menu item 118 POWER SAVINGS controls the power circuitry for both the embedded *b*-LAN module and the GAME CONTROL/MPI port. The default value is 3—the *b*-LAN module is only powered when the TV is turned ON. See chart below.

POWER SAVINGS	TV OFF	TV ON
	<i>b</i> -LAN & GAME CONTROL/MPI Port Power	<i>b</i> -LAN & GAME CONTROL/MPI Port Power
1	On	On
3 (default)	Off	On

A *b*-LAN enabled head end device, such as an LG FMA-LG101, broadcasts over the RF distribution system to communicate to multiple TVs. When the TV is first installed, it must be turned ON in order for its embedded *b*-LAN module to receive communication from the head end device. At this point, if it is desired for the *b*-LAN module to always be powered, including while the TV is turned OFF, set Installer Menu item 118 POWER SAVINGS to 1.

Also, if MPI communication is required for external MPI control, set Installer Menu item 118 POWER SAVINGS to 1 so that the GAME CONTROL/MPI port circuitry is always powered.

 **Caution: POWER SAVINGS should NEVER be set to 7. This setting is intended for factory use only.**

Reference: FTG Mode via EBL (Local Configuration)

The following steps outline local FTG configuration of individual TV EBLs using a direct PC-to-TV (EBL) connection. Refer to the **Free-To-Guest (FTG) Device Configuration Application User Guide** for further information.

FTG Device Configuration Application software is available online at: www.LGolutions.com/ftgsoftware.

Note: If the TV CPU is already in FTG Mode, you cannot use this procedure to make changes to the FTG Channel Map and FTG Installer Menu settings. Refer to FTG Mode information on pages 7 to 9 for further details.

Note: If the preceding condition applies, but you wish to switch the TV to FTG Mode via EBL, see Reference section, "Restoring Factory Defaults on the TV(s)," for further information before proceeding.

1. Install (if necessary) and launch the FTG Device Configuration Application (v5.4.8 or higher) on the PC that will be used to configure the EBL.
2. Build an FTG Channel Map using the FTG Channel Map Editor in the FTG Channel Map Configuration Utility (or, if applicable, open an existing FTG Configuration [.rml] file).

Note: Up to 141 logical channels can be defined in the FTG Channel Map.

3. Connect the PC to the TV-LINK CFG jack on the TV's rear jack panel using a USB-to-TTL serial cable (TTL-232R-5V-AJ). If necessary, install the device driver on the PC.

4. Turn ON the TV.

Note: If Installer Menu item 118 POWER SAVINGS is set to 3 (default), the TV must be ON in order for steps 5 and 6 below to be successful.

5. "Write" the FTG Channel Map to the EBL (switches the EBL from Pass-through Mode to FTG Mode).

Note: After a "Write" of new data, the TV will briefly display a green text banner that shows the EBL firmware version and release date.

6. "Read" the current FTG Installer Menu settings from the EBL using the FTG Installer Menu Configuration Utility. If necessary to make changes to Installer Menu items, "Write" them back to the EBL in FTG Mode.

7. Save the FTG Channel Map and FTG Installer Menu settings to an FTG Configuration (.rml) file for future use.

8. Tune the TV to a logical channel in the FTG Channel Map.

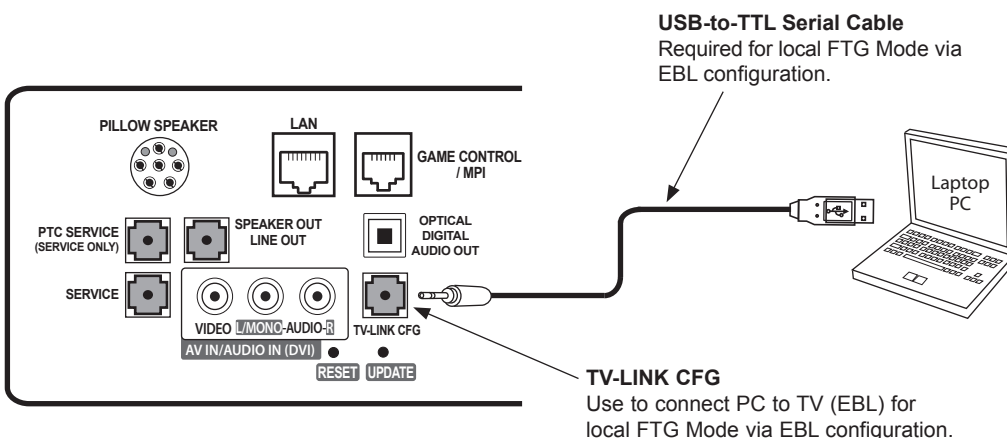

Reference: Auto Input(s) Sensing Feature

This section provides detailed settings information for Installer Menu item 042 AUTO INPUTS.

Note: When both item 042 AUTO INPUTS *and* item 041 SIMPLINK EN are enabled in the Installer Menu, HDMI inputs will be detected by SIMPLINK, but the Auto Input(s) Sensing Feature will not function.

In the Installer Menu, an informational code is displayed at the right of each Auto Inputs value, for example:

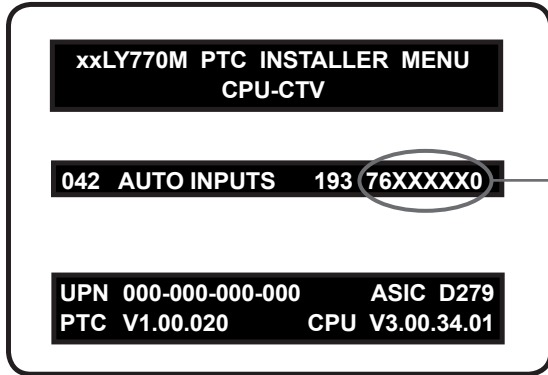

AUTO INPUTS Display Code

This example illustrates Installer Menu item 042 value 193, which enables auto-sensing for all available Aux inputs. The input #s in the display code (7, 6, 0 in this example) identify the enabled Aux inputs. See table below for a listing of the LY770M Aux inputs and their corresponding display code input #s. The second table below shows the display codes for all item 042 values.

Each code consists of eight characters that identify the Aux input(s) for which auto-sensing is enabled. The following table identifies the Installer Menu display code Input # for each Aux input that is available on the LY770M TV models. The table also identifies the Installer Menu item associated with each Aux input. Remember that in order for auto-sensing to be enabled for an input, that input must also be enabled in the Installer Menu.

Installer Menu Display Code Input #	Aux Input	Installer Menu	
		Item	Function
0	AV1	039	REAR AUX EN
6	HDMI 1	035	HDMI1 ENABLE
7	HDMI 2	091	HDMI2 ENABLE

To disable auto-sensing for all available Aux inputs, set item 042 to 0. To enable auto-sensing for all available Aux inputs, set item 042 to 255. All other available settings (i.e., settings for individual inputs) are listed in the table below.

Item 042 Value	Inputs			Installer Menu Display
	AV1	HDMI 1	HDMI 2	
001	Enabled	Disabled	Disabled	DDXXXXX0
064	Disabled	Enabled	Disabled	D6XXXXXD
065	Enabled	Enabled	Disabled	D6XXXXX0
128	Disabled	Disabled	Enabled	7DXXXXXD
129	Enabled	Disabled	Enabled	7DXXXXX0
192	Disabled	Enabled	Enabled	76XXXXXD
193	Enabled	Enabled	Enabled	76XXXXX0

X = Aux input source is Disabled or Not Available (i.e., on these TV models)

D = Auto-sensing for input is Disabled

Input # = Auto-sensing for input is Enabled

Reference: LY770M Hospital Operations

Hospital Features

The following table identifies when and how the LY770M hospital features are supported in three different TV configurations. As indicated in the introduction to this document, LG commercial TV functionality is based on “ownership” of the Channel Map. For the purposes of this table, “CPU” indicates that the TV is in Pass-through Mode with the Channel Map in the CPU (i.e., auto-tuned/edited channel lineup) and “PTC” indicates that the TV is in Pass-through Mode with the Channel Map in the PTC (i.e., if the Express Script was run).

Hospital Mode State	Item	CPU		PTC		FTG/PPV Mode	
		Disabled	Enabled	Disabled	Enabled	Disabled	Enabled
Installer Menu	Item						
IR Banks Enable	012				X		
Scan Mode	013	(a)	(a)	X	X	X*	X*
Start Channel in Scan Mode	014			X	X	X*	X*
Feature Level	020						
Bed 1/Bed 2	020	X		X		X	
Multi-code IR	020	X	X	X	X	X	X
Speaker	020	X		X		X	
Function Preview	025			X	X		
Hospital Mode	027						
Bed 1/Bed 2	027		X		X		X
Pillow Speaker Voltage	027	(b)	X	(b)	X	(b)	X
Speaker	027		X		X		X
Quick Shutoff	077	(c)	(c)	(c)	(c)	(c)	(c)
Channel Banks							
Number of Banks Enabled				1	4		
Channel Preview/Banks Setup Menu				X	X		
Blanked Channel				X	X	X	X
Inactive TV					X		
SAP Key					X		
Aux Input Sources							
Input List Menu		X	X	X		X	X
Aux in Scan List				X	X	(d)	(d)
TV Setup Menus							
Audio (TV Speaker)		(e)	(e)	(e)	(e)		
Option (Power Indicator)		X	X	X	X		

* Applicable for FTG Mode via CPU only.

X = feature supported

a) Turn ON function only. Always goes to channel 2-0.

b) Defaults to Zenith pillow speaker code/(+12v) supply voltage.

c) Quick Shutoff feature only functions when Scan Mode is enabled and if you are using an analog pillow speaker.

d) Dependent upon installer-defined FTG/PPV Channel Map.

e) Audio Menu is only accessible when the speaker selected is TV Only or both TV & Pillow.

Reference: LY770M Hospital Operations (Cont.)

Speaker Selection

The following table outlines speaker settings as determined by Installer Menu items 027 HOSPITAL MODE and 020 FEATURE LEVEL.

Item 027 HOSPITAL MODE Value	Item 020 FEATURE LEVEL Value	Audio Menu TV Speaker	Speaker
0	0 ~ 24	OFF	None
0	0 ~ 24	ON	TV Only
0	64 ~ 65	N/A	Pillow Only
1 ~ 34	N/A	N/A	Pillow Only
65 ~ 98	N/A	OFF	None
65 ~ 98	N/A	ON	TV Only
129 ~ 162	N/A	OFF	Pillow Only
129 ~ 162	N/A	ON	Pillow & TV

Note: If the TV is in FTG Mode, the Audio Menu is no longer accessible.

Reference: Restoring Factory Defaults on the TV(s)

This section describes how to restore all factory defaults or just the Installer Menu factory defaults either on a single TV that is currently in Pass-through or FTG Mode or on multiple TVs that are currently in FTG Mode.

Restore All Factory Defaults

This section describes how to restore a single TV, regardless of its current mode, to a factory default condition. The following procedure requires that you contact LG technical support to obtain a predefined value/password for Installer Menu item 117 FACT DEFAULT that enables access to initiate a factory “IN-STOP” process. This procedure will also reactivate the LG Setup Wizard.

1. Use the Installer Remote to access the TV’s Installer Menu.
2. Navigate to Installer Menu item 117 FACT DEFAULT, and key in the value provided by technical support. Then, press **OK**.
3. At the prompt for confirmation, key in the password provided by technical support. This will initiate the IN-STOP that restores the factory defaults on the TV.

Installer Menu Item 117 FACT DEFAULT

If the TV is currently in Pass-through Mode, you can set Installer Menu item 117 FACT DEFAULT to 1 to restore the Installer Menu factory defaults and clear the PTC Channel Map, including any assigned channel icons and custom text labels. Note, however, that if a complete restoration of the TV’s factory defaults is required, see “Restore All Factory Defaults” above.

Additional FTG Mode via CPU Options

There are two additional options for restoring Pass-through Mode/Installer Menu factory defaults on TVs that are in FTG Mode via the CPU. The first enables you to restore a single TV to Pass-through Mode, while the second enables you to restore multiple TVs to Pass-through Mode at one time. However, both options require that you create a “Zero Mapped Channels” FTG Configuration (.tlx) file, i.e., an FTG Configuration file with no data. Refer to the *Free-To-Guest (FTG) File Manager User Guide* for further information.

- Using a USB memory device, “Teach” a “Zero Mapped Channels” FTG Configuration (.tlx) file to the TV. Refer to “Teaching Configuration to a Target TV” on pages 55 to 58 for further information on Teaching.
- If your system uses a Pro:Centric server for remote management, use the Pro:Centric server Admin Client to load a “Zero Mapped Channels” FTG Configuration (.tlx) file on the Pro:Centric server. Refer to the *Pro:Centric Server Admin Client User Guide* for further information.

Additional FTG Mode via EBL Options

There are two additional options for restoring Pass-through Mode/factory defaults on TVs that are in FTG Mode via the EBL. The first enables you to restore a single TV to Pass-through Mode, while the second enables you to restore multiple TVs to Pass-through Mode at one time.

 **Note: While the IN-STOP process described above will clear both the PTC and the CPU, both options below only clear the PTC. Thus, the current Channel Map and TV setup menu settings will remain in the CPU after the reset is completed.**

- Using a direct PC-to-TV connection, “Write” an unpopulated Channel Map—that is, a Channel Map with 0 (zero) channels—to the TV. See Reference section, “FTG Mode via EBL (Local Configuration),” and/or the *Free-To-Guest (FTG) Device Configuration Application User Guide* for further information.
- If your system uses an FMA for remote management/broadcast configuration, configure the FMA device with an FMA Configuration (.fma) file that only contains a “0 Mapped Channels” FTG Channel Map to broadcast to the TV EBL(s). Refer to the *Free-To-Guest (FTG) Device Configuration Application User Guide* and/or the Installation & Configuration Guide for the FMA device for further information.

Reference: Using the TV's Zoning Features

This section describes the TV Zoning and Wi-Fi Zoning features available with the LY770M model TVs. These features are primarily intended for use when the TV is configured for FTG Mode via CPU operation; however, Wi-Fi Zoning, along with selected elements of TV Zoning (Installer Menu and TV Setup Menu profile Zone assignments), may also be used with TV cloning processes using a USB memory device / TLX file. Refer to the appropriate section(s) below for further information on the Zoning features and how to set the TV or Wi-Fi Zone # in a TV that is currently in Pass-through Mode.

TV Zoning Feature

The TV Zoning feature enables you to create localized configurations for TVs in selected locations, or "Zones," within the installation environment, for example, a hotel lobby, fitness center, restaurant, etc.

Using the TV Zoning Feature with FTG Mode via CPU Configuration

The FTG File Manager may be used to create an FTG Configuration (.tlx) file that contains multiple Installer Menu and TV Setup Menu profiles, each with its own Zone assignment. Up to nine unique Zones can be designated for LY770M FTG Installer Menu and/or TV Setup Menu profiles. Zone restrictions can also be placed on individual channels in the FTG Channel Map. Thus, for example, you may create an FTG Installer Menu and/or TV Setup Menu profile to specifically configure a TV in the hotel lobby and also restrict the channels that are available to be tuned on that TV.

The TV Zone # must be set appropriately on each TV in order for the TVs to be configured correctly. See "Set the TV Zone # and/or Wi-Fi Zone # in the TV" on page 87, and set the TV Zone # in all the TVs in a select area, so that the TVs are configured with corresponding FTG Installer Menu and/or TV Setup Menu settings and/or can omit channels that have been restricted in the FTG Channel Map. TV Zone 0 is the default TV Zone #.

The following subsections briefly describe how to assign Zone designations in the FTG File Manager. Refer to the **Free-To-Guest (FTG) File Manager User Guide** for further information.

FTG Installer Menu Profile Zone Assignments

The FTG File Manager main screen enables you to change the Zone assignment (default = Zone 0) for each Installer Menu profile to be included in an FTG Configuration (.tlx) file. For example, you may wish to create one LY770M Installer Menu profile for the hotel lobby and another LY770M Installer Menu profile for the fitness center, both of which are different from the Installer Menu profile used for standard guest rooms. The TV Zoning feature enables you to save multiple LY770M FTG Installer Menu profiles, each with its own Zone assignment, in one FTG Configuration file. If each TV in the aforementioned locations (Zones) has had its TV Zone # set appropriately, as described in the procedure on page 87 or via the EZ-Manager (if applicable), the TV(s) will only be configured by the Installer Menu profile that matches its(their) Zone setting.

In the FTG File Manager main screen, you can also edit the Zone assignment for each Installer Menu profile and/or TV Setup Menu profile already present in the FTG Configuration List and TV Setup Menu List windows.

Note: See also the FTG File Manager main screen overview on page 61. In addition, note that TV Setup Menu profiles cannot be created in the FTG File Manager; they must be "Learned" from a TV.

FTG Channel Map Zone Restrictions

The FTG Channel Map Editor in the FTG File Manager's FTG Channel Map Configuration Utility enables you to place Zone restrictions on individual channels that may be prohibited or deemed unsuitable for certain locations. In the FTG Channel Map Editor, one or more Zone restrictions (1–8) may be placed on each channel that is to be restricted. For example, if you wish to restrict a channel from Zones 2 and 4, select both "Zone 2" and "Zone 4" in the Zone Restriction section of the FTG Channel Map Editor screen when defining or editing that channel.

Reference: Using the TV's Zoning Features (Cont.)

Note: While a channel can be restricted from up to eight Zones, a TV can only ever be in (set for) one Zone. See also the FTG Channel Map Editor overview on page 63.

At the same time, keep in mind that the TV Zone designations are not mutually exclusive. That is, you may opt to place Zone restrictions on selected channels in the FTG Channel Map, but at the same time, you can choose to configure all TVs at the site with the same Installer Menu and/or TV Setup Menu settings. For example, an FTG Configuration (.tlx) file being used to configure the TVs at a site may contain multiple Installer Menu and TV Setup Menu profiles with different Zone assignments, as well as an FTG Channel Map with Zone restrictions on several channels. Each TV that still has the default TV Zone 0 setting will *only* be configured by the Installer Menu and/or TV Setup Menu profile(s) with a Zone 0 designation. If, on the other hand, the TV Zone # is set to 1, the TV will first look in the file for the LY770M Installer Menu and/or TV Setup Menu profile(s) with a Zone 1 designation. If none of the LY770M Installer Menu and/or TV Setup Menu profiles has a Zone 1 designation, the TV will then look for the LY770M profile(s) with a Zone 0 designation. For the FTG Channel Map configuration, when the TV Zone # is set to 0, the TV will ignore any Zone restrictions (1–8) that may be placed on channels in the FTG Channel Map. However, when the TV Zone # is set to 1, the TV will omit any channels that have been restricted from Zone 1 in the FTG Channel Map.

Using the TV Zoning Feature with Cloning Configuration

A location-specific configuration / TLX file may be saved (Learned) from an individual TV as part of a Master TV Setup and then be used during Teaching. For example, if the TV Zone # in the Master TV is set to 3 before Learning is initiated, the Master TV's Installer Menu and TV Setup Menu profiles will be saved with the TV Zone 3 assignment when Learning is completed. In order to configure the Target TVs with the Zone 3 Installer Menu and TV Setup Menu profiles Learned from the Master TV, you must set the TV Zone # accordingly in the Target TVs before transferring (Teaching) the Master TV Setup. See "Set the TV Zone # and/or Wi-Fi Zone # in the TV" on the following page. Also, see "Cloning Procedures" on pages 53 to 58 for additional information on the cloning processes. TV Zone 0 is the default TV Zone #.

Wi-Fi Zoning Feature

The Wi-Fi Zoning feature enables you to use a TLX file to configure an individual TV or group of TVs with a particular Wi-Fi access point's login data to create "Wi-Fi Zones" within the installation environment.

Using the Wi-Fi Zoning Feature with FTG Mode via CPU Configuration

The FTG File Manager may be used to create an FTG Configuration (.tlx) file with an FTG Installer Menu profile that contains login data for multiple Wi-Fi access points, each assigned a Wi-Fi Zone #. Up to 100 Wi-Fi Zones can be designated within each FTG Installer Menu profile, thus allowing for distribution of the Wi-Fi network load. For example, if a site has 50 LY770M TVs within close proximity, you may wish to create 10 Wi-Fi Zones, each with its own access point that has unique login data, so that no more than five of the TVs are connected to one access point at any given time.

In order for a TV to be configured by the proper Installer Menu profile with the desired Wi-Fi access point login data for wireless networking (i.e., SSID, security type, and security key), you must set both the TV Zone # and the Wi-Fi Zone # in the TV (see "Set the TV Zone # and/or Wi-Fi Zone # in the TV" on the following page for further information). If the Wi-Fi Zone # in the TV is set to 0 (default), the TV will not obtain access point login data from the Installer Menu profile with which it is configured unless the profile contains the global Wi-Fi Zone 100. Similarly, any TV that does not find its matching Wi-Fi Zone # in the TLX file, but that does find the global Wi-Fi Zone 100, will be configured with the global access point login data.

Refer to the **Free-To-Guest (FTG) File Manager User Guide** for further information on defining Wi-Fi Zones in the FTG File Manager.

Using the Wi-Fi Zoning Feature with Cloning Configuration

A location-specific Wi-Fi configuration / TLX file may be saved (Learned) from an individual TV as part of a Master TV Setup and then be used during Teaching. First, the wireless network (i.e., the access point login data) must be configured in the Master TV's IP Environment Menu (see "Configuring a Wi-Fi Network Connection" on page 69). Then, a Wi-Fi Zone # must be set in the Master TV (see "Set the TV Zone # and/or Wi-Fi Zone # in the TV" below). If desired, a TV Zone # may also be set in the Master TV.

For example, if the Wi-Fi Zone # is set to 4 and the TV Zone # is set to 5 before Learning is initiated, after Learning is completed, the Master TV's Installer Menu profile will be saved with the Zone 5 assignment, and within that Installer Menu profile, the access point login data for wireless networking (i.e., SSID, security type, and security key) will be saved with a Wi-Fi Zone 4 assignment. In order to configure the Target TVs with the proper Installer Menu profile and access point login data, you must set both the TV Zone # and the Wi-Fi Zone # in the Target TVs accordingly before transferring (Teaching) the Master TV Setup. See "Set the TV Zone # and/or Wi-Fi Zone # in the TV" below. Also, see "Cloning Procedures" on pages 53 to 58 for additional information on the cloning processes. If the Wi-Fi Zone # in the TV is set to 0 (default), the TV will not obtain access point login data from the Installer Menu profile with which it is configured unless the profile contains the global Wi-Fi Zone 100. Similarly, any TV that does not find its matching Wi-Fi Zone # in the TLX file, but that does find the global Wi-Fi Zone 100, will be configured with the global access point login data.

Set the TV Zone # and/or Wi-Fi Zone # in the TV

You can set the TV Zone # and/or the Wi-Fi Zone # in the EZ-Manager Wizard (see "EZ-Manager Wizard" on pages 14 to 22) or, if the TV is in Pass-through Mode, via the TV's setup menus as described below. Note that the following procedure can only be performed while the TV is in Pass-through Mode. You will also be able to specify a Label (North, South, East, West) and Room Number for this TV, if desired.

1. Turn ON the TV.
2. Press **MENU** on the Installer Remote, and use the arrow navigation keys to select/highlight the **General** menu option. Then, press **OK**.
3. In the General Menu, use the Up/Down arrow keys to select **Room Info**, and then press **OK**.
4. In the Room Info screen, complete the appropriate fields as described below. Use the Up/Down arrow keys on the Installer Remote to navigate between each of the fields.
 - **Wi-Fi Zone:** Enables you to set a Wi-Fi Zone # so that the TV can be configured with a particular access point's login data for wireless networking. Login data (i.e., SSID, security type, and security key) may be provided in a TLX file to be used for configuration.
To assign a Wi-Fi Zone, select/highlight the **Wi-Fi Zone** field and press **OK**. Then, use the Left/Right arrow keys to specify the desired Wi-Fi Zone # (1–99). Press **OK** when you are finished.
 - **TV Zone:** Enables you to set a TV Zone # so that the TV can be configured with Installer Menu and/or TV Setup Menu settings intended only for the assigned Zone. The Installer Menu and/or TV Setup Menu settings may be provided in a TLX file to be used for configuration. If the TV is being configured for FTG Mode via CPU, the TV Zone # setting also allows the TV to omit channels that have been restricted in the FTG Channel Map.
To change the TV Zone, select/highlight the **TV Zone** field and press **OK**. Then, use the Left/Right arrow keys to specify the desired TV Zone # (0–8). Press **OK** when you are finished.

(Continued on next page)

Reference: Using the TV's Zoning Features (Cont.)

(Continued from previous page)

- **Label:** Allows you to select a North, South, East, or West text label for this TV. Select/highlight the **Label** field and press **OK**. Then, use the Up/Down arrow keys to select the applicable label. Press **OK** when you are finished.
 - **Room Number:** Allows you to specify the number of the room in which the TV is located. To enter a room number, use the Up/Down arrow keys to select/highlight the **Room Number** field and press **OK**. You can then use the number keys on the Installer Remote to directly enter a room number, or you can use the arrow keys to select the appropriate alphanumeric character(s) from the pop-up virtual keyboard at the bottom of the screen. When you are done, select **Enter** from the virtual keyboard, and then press **OK** on the Installer Remote.
5. When you have completed the fields as necessary, press **↵** to return to and/or exit the TV menus, or press **MENU** to return to program viewing.

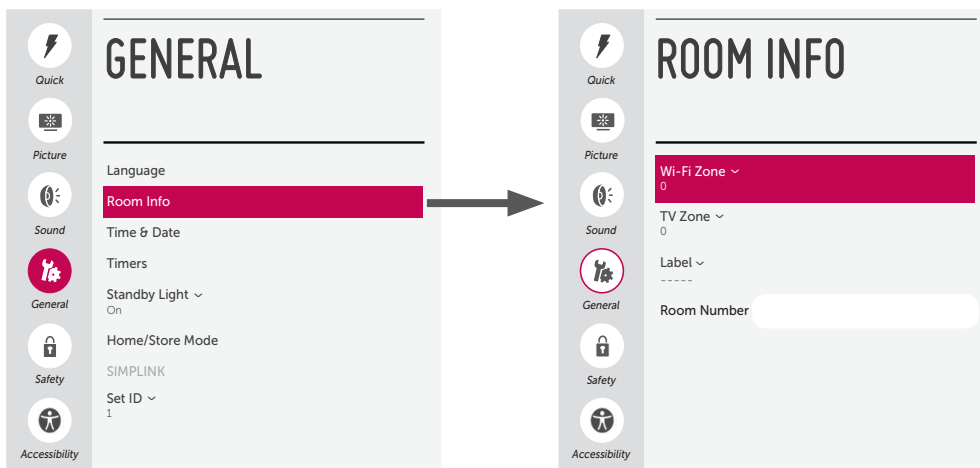

Reference: Using Media Share Features

When the TV's Smart Share, Screen Share, and DMR options are enabled in the IP Environment / Media Share Menu (see "Accessing the IP Environment Menu" and "Media Share Setup" on pages 65 and 71, as necessary), guests have the ability to use the following Media Share features:

- Smart Share: Allows guests to use the TV to access and view media files (photos, videos, music, etc.) shared either by wired DLNA Certified devices (the devices must be connected to the same LAN as the TV) or wireless LG devices using LG's Smart Share application with Wi-Fi Direct.
- Screen Share: Allows guests to select a Miracast or WiDi capable device, whose screen can be displayed on the TV.

This section provides an overview of the Smart Share and Screen Share functionality.

Smart Share

The following steps describe how to access and use the Smart Share feature, either with wired DLNA Certified devices on the same LAN as the TV or using wireless LG devices/Wi-Fi Direct. If you intend to connect to an LG device using Wi-Fi Direct, remember that you must also turn ON Wi-Fi Direct and launch the Smart Share application on the LG device.

1. Turn ON the TV.

The next step depends on whether you need to turn ON Wi-Fi Direct (i.e., to connect to a wireless LG device):

- If you do not need to turn ON Wi-Fi Direct, you can proceed directly to step 7.
- Otherwise, press **MENU** on the Installer Remote to display the TV menus (either the setup menus or the Function Menu depending on whether the TV is or is not in Pass-through Mode). Then, continue with step 2.

2. Use the Up/Down arrows to select/highlight the **General** menu icon, and then press **OK**.

3. In the General Menu, use the Up/Down arrows to select **Wi-Fi Direct**, and then press **OK**.

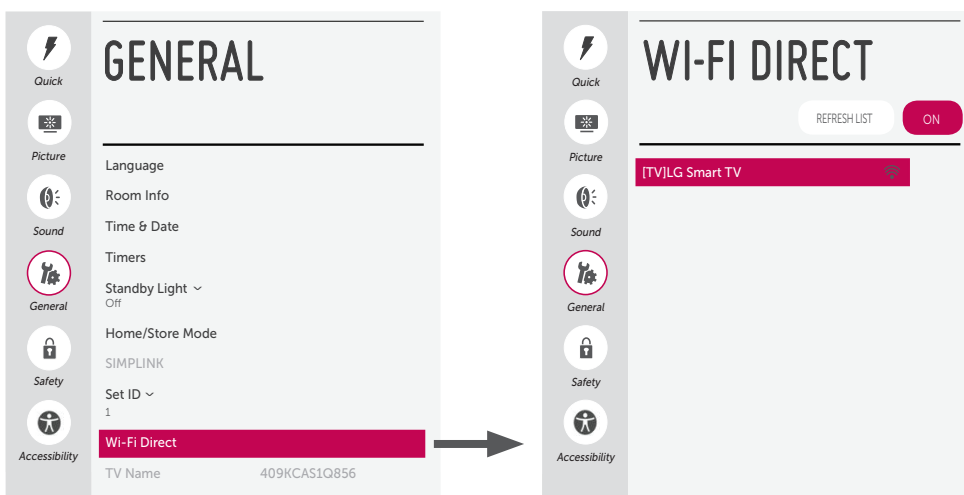

Note: The example at left shows the General Menu when the TV is in Pass-through Mode. The Wi-Fi Direct screen is the same whether the TV is or is not in Pass-through Mode.

(Continued on next page)

Reference: Using Media Share Features (Cont.)

(Continued from previous page)

4. When you initially access the Wi-Fi Direct screen, the OFF/ON toggle button at the top right of the screen is selected/highlighted by default. If Wi-Fi Direct is currently OFF, press **OK** on the Installer Remote to turn Wi-Fi Direct ON. This will prompt the TV to search for all available Wi-Fi Direct enabled wireless devices, including mobile devices, laptops, etc. Devices found will be listed in the lower half of the screen.

Note: If the search does not initially locate any devices, you can select **REFRESH LIST** and press **OK** to rescan.

5. Use the Up/Down arrow keys to select/highlight the device with which you wish to share, and then press **OK**.

6. A pop-up window will prompt you to confirm your connection request. Select **Yes** and press **OK** to continue.

The share request will be sent to the targeted device. The user of that device may choose to allow or not allow the share connection. Similarly, once Wi-Fi Direct is turned ON, other devices may request share connections with this TV (pop-up share requests typically appear in the bottom right of the TV screen).

7. Use one of the following methods to access media files/folders, depending on the current configuration of the TV:

- If the TV is in Pass-through Mode (i.e., the Pro:Centric application is not loaded), press the **PORTAL** button on the Installer Remote, and use the Left/Right arrow keys to select **SmartShare** from the TV's Smart Launcher.
- If the TV is not in Pass-through Mode, use the Up/Down arrow keys on the Installer Remote to select the **SmartShare** option from the General Menu.

Note: Depending on the remote control being used (in any mode), you may also access the Smart Launcher via the SMART button.

8. In the Smart Share screen, select the desired Smart Share device, and then select the desired media category to view files.

Screen Share (Miracast / WiDi)

The following steps describe how to access and use the Miracast / WiDi features.

1. Turn ON the TV, and then use one of the following methods to access the Screen Share application, depending on the current configuration of the TV:

- If the TV is in Pass-through Mode (i.e., the Pro:Centric application is not loaded), press the **PORTAL** button on the Installer Remote, and use the Left/Right arrow keys to select **Screen Share** from the TV's Smart Launcher.
- If the TV is not in Pass-through Mode, press **MENU** on the Installer Remote to display the Function Menu, use the Up/Down arrows to select/highlight the **Input** menu icon, and then press **OK**. Then, use the Up/Down arrows to select the **Screen Share** option from the Input Menu.

Note: Depending on the remote control being used (in any mode), you may also access the Smart Launcher via the SMART button.

2. Follow the on-screen instructions to initiate the Miracast / WiDi connection from your Miracast / WiDi device. Note that you may be prompted to enter a PIN number that appears on the TV screen into your Miracast / WiDi connection window to complete the connection.

Once the connection is established, the TV display may be used as a second screen for the Miracast / WiDi device.

Reference: LY770M Rear and Side Jack Panels

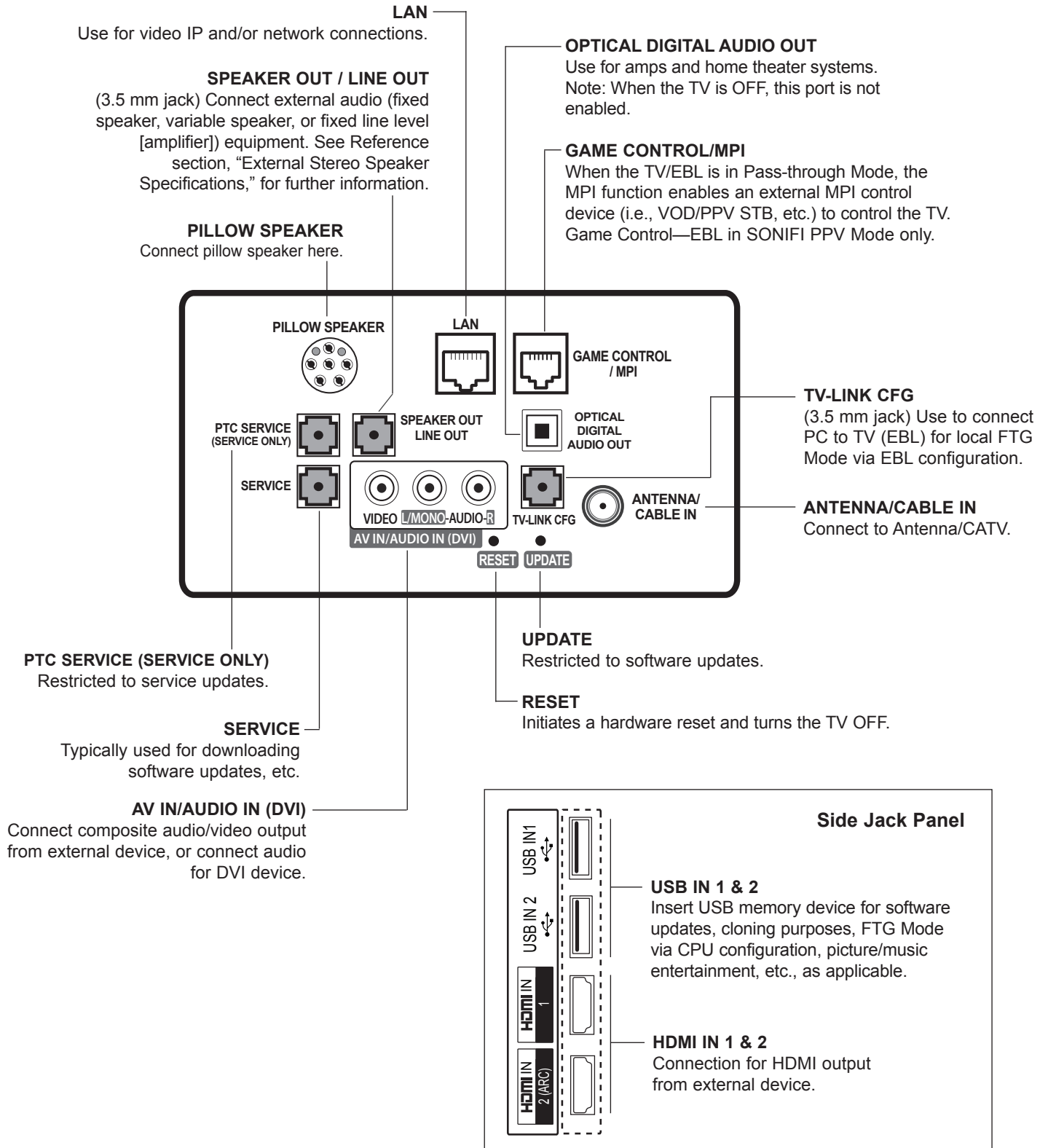

Reference: External Stereo Speaker Specifications

The SPEAKER OUT / LINE OUT 3.5 mm stereo jack on the LY770M rear panel provides stereo speaker signal outputs (fixed speaker, variable speaker, or fixed line level [amplifier]) for external audio equipment. Set Installer Menu item 097 AUDIO OUTPUT as required in accordance with external audio equipment connected to the TV. Also, refer to the following diagram for pinout details.

 **Caution: Do NOT plug in a mono connector, as this may damage the TV.**

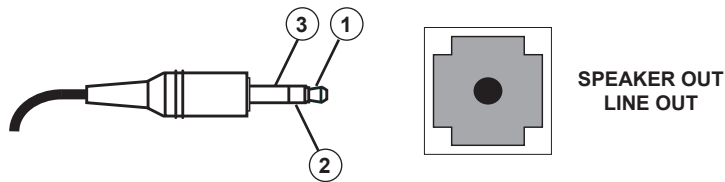

-
- | | |
|---|-----------------|
| 1 | LEFT (Tip) |
| 2 | RIGHT (Ring) |
| 3 | GROUND (Sleeve) |
-

Reference: Installer Remote Control Typical Key Functions

An LG Installer Remote is required to set up and operate the TV. The LG Installer Remote illustrated below shows typical remote control functions and is provided for reference only.

TV LG1/TV LG2 & TV Z1/TV Z2
Selects the LG or Zenith IR codes sent by the remote. In order for the TV to respond, this setting must match the setting in the TV.

Numbers (0 - 9) & DASH
Use to enter a channel or program number. Dash is used for sub-channel numbers such as 9-1, 9-2, etc.

FLASHBK (Flashback)
Returns to the previously tuned channel.

CHANNEL UP/DOWN
Changes channels based on channels in the channel lineup.

VOLUME UP/DOWN
Increases/decreases sound level.

Arrows (Up/Down/Left/Right) & OK
Use to navigate on-screen menus, direct tune channels, and adjust TV settings.

CH. BANK
Selects Channel Bank 1, 2, 3, or 4 when Hospital Mode is enabled and the channel lineup resides in the TV's PTC. Otherwise, this button displays available Aux inputs.

CH. PREVIEW
Displays and exits the Channel Preview/Banks Setup Menu.

MUTE
Switches sound On or Off.

TIMER
Sets the amount of time before the TV automatically turns itself Off.

ALARM
Enables users to schedule a one-time "alarm" event, in which the TV turns itself On at the user-specified time.

EXIT
Clears all on-screen displays and returns to program viewing.

POWER
Turns the TV On or Off.

MENU
Displays and removes the TV setup menus (or, if applicable, the Function Menu).

PORTAL
Displays and removes the Pro:Centric interactive menu.

INFO
Displays channel information.

GUIDE
Displays and removes the Pro:Centric channel guide/EPG.

↵ (RETURN)
Returns one level to the previous menu/display.

Color buttons access special functions in some menus.

CC
Activates subtitles, unless the Channel Preview/Banks Setup Menu is currently on the screen, in which case this option displays the Lock (V-Chip) Menu.

SAP
Analog Mode: Selects MTS sound (Mono, Stereo, or SAP). DTV Mode: Changes the audio program language, if additional languages are available. *

*** SAP notes:**

- If SAP is selected and no SAP is provided, sound may not be heard on channel.
- Each channel may have its own SAP setting.
- Each time digital channels are tuned, the TV attempts to locate the default audio program language. If the default audio program language is not available, the TV will use the first available audio program.

Reference: Pro:Centric Pillow Speaker and Patient Remote Options

LG Pro:Centric pillow speakers and/or patient remotes are available for purchase (see examples at right). For additional information and/or to purchase a Pro:Centric pillow speaker or patient remote, please contact your LG service representative.

Pillow Speaker and Patient Remote Functionality

Both the Pro:Centric pillow speaker and the Pro:Centric patient remote provide access to Pro:Centric application features (via PORTAL, INFO, and GUIDE buttons). See also “Installer Remote Control Typical Key Functions” on the previous page for further information on button functions.

USB Media Navigation

This section provides a brief overview of the Pro:Centric pillow speaker and Pro:Centric patient remote navigation tools for use with USB media files (photos, videos, music, etc.).

Note: The Pro:Centric pillow speaker is currently the only pillow speaker that enables users to navigate and play/view USB media files.

Note: Refer to the Owner’s Manual for detailed information on USB memory device requirements and the types of media supported by the LY770M TVs.

1. Insert the USB memory device into either of the TV’s USB ports.

Once the TV detects the USB device, a SmartShare icon will be displayed on the screen. Press **Enter** (pillow speaker) or **OK** (patient remote) to access the SmartShare application.

2. Use the arrow keys on the pillow speaker/patient remote to select/highlight the desired option(s) in the SmartShare screen, and then press **Enter/OK**.

3. Within each USB media directory (Photos, Videos, or Music):

- Use the arrow keys on the pillow speaker/patient remote to navigate from one folder or file to another, and press **Enter/OK** to open or play a selected folder or file.
- Use the arrow keys on the pillow speaker/patient remote, as necessary, to scroll through all available files.
- In View and Play modes, you typically can use the pillow speaker/patient remote to navigate to another directory level (without exiting the SmartShare application).
- To exit the SmartShare application, press **Return** (pillow speaker) or **↵** (patient remote). The TV’s Smart Launcher will be displayed along the bottom of the screen, and you can use the Left/Right arrow keys on the pillow speaker/patient remote to select **LiveTV** to return to program viewing. If you wish to relaunch the SmartShare application, you must physically remove and then reinsert the USB memory device.

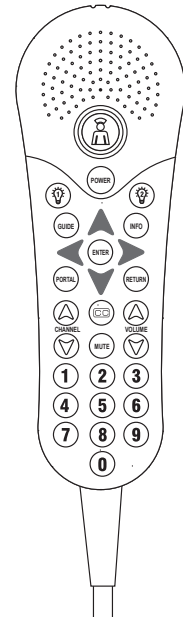

Typical Pro:Centric Pillow Speaker



Typical Pro:Centric Patient Remote

Reference: Pillow Speaker Setup

The pillow speaker will only be functional after the Express Script/Custom Master TV Setup and/or cloning procedures are complete.

Note: When Installer Menu item 027 HOSPITAL MODE is set to 254 (factory default value), there is no power (voltage) supplied to the pillow speaker.

Connecting a Pillow Speaker to the TV

Connect the pillow speaker (see example at right) to the PILLOW SPEAKER interface on the rear jack panel of the TV.

 **Caution:** Use a pillow speaker that is a UL recognized pendant control bearing the warning: "Risk of fire if used in oxygen enriched atmosphere. Keep pendant control away from oxygen equipment."

Controlling the TV with Serial Data

These TV models are capable of being controlled by a single-wire, serial data signal. This is an LG patented technology and is being implemented by certain brands of "smart" pillow speakers.

Pillow Speaker Interface

This connector provides an interface for patient-pendant remote control or entertainment audio and nurse call systems. All lines are isolated from the AC power line. (Optoisolators isolate the control lines, and a transformer isolates the audio.) Earth ground is provided on pin 4 (Common) in the default configuration (e.g., for Zenith/Philips pillow speakers). For negative voltage configuration (e.g., for RCA pillow speakers), +5 volts is provided on pin 4 (Common), with pin 3 (Channel Up/Data In) referenced to ground.

The following table describes the pillow speaker interface pinout (see also diagram at right).

Pin No.	Description
1	Analog external control for TV ON/OFF.
2	No connection
3	Analog external control for Channel Up or Serial Data In.
4	Common connection for control, data, and audio output.
5	Isolated Audio Output. Nominal 14 ohm source impedance with short circuit protection. Intended for a pillow speaker with a low-impedance, pad-type volume control.
6	Analog external control for Channel Down.

Controlling the TV with Mechanical Switches

A typical analog pillow speaker with mechanical switches will momentarily connect pin 1, 3, or 6 to pin 4 (Common) to control Power ON/OFF, Channel Up, or Channel Down (see schematic at right). These pins are at +13 volts DC (when measured from pin 4) with the switches open. Typical current draw is 8 mA when a switch is closed. (This operation is identical to previous models using the 5-wire interface, except that only +7 volts DC was supplied and current draw was only 2.5 mA.)

Typical Pillow Speaker (Serial Data Control)

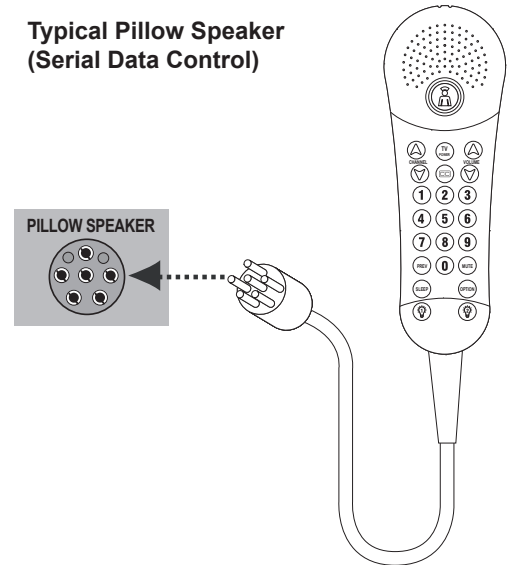

Pillow Speaker Interface Pinout

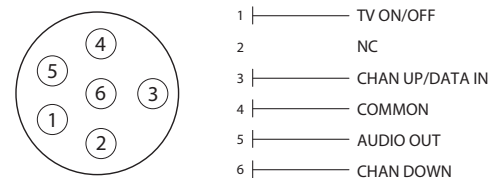

Typical Schematic for Analog Pillow Speaker

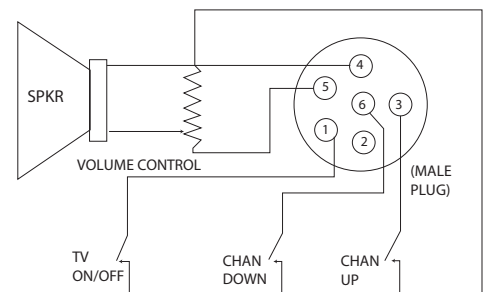

Reference: VESA Standard TV Mounts

General Guidelines: Choosing a Location for Installing a VESA Standard Mount

To the right are some examples of VESA standard mounts. Since there are numerous types of stands and mounts available, only a few are shown here. Refer to the instructions provided with the TV stand that will be used to mount the TV. Be sure the style of stand selected is capable of supporting the weight of the TV and is appropriate for the application.

Wall Mounts

If the mount will be on a wall, a typical wooden stud behind the wall board would be the preferred choice for a location to attach the wall mount. The wall mount location chosen should be appropriate for drilling holes and have available the required power source as well as antenna/cable and any other equipment leads as necessary.

Pedestal Mounts and Stands

A sturdy surface on a desk or other similar flat table-like furniture would be the appropriate location for mounting a pedestal-style TV stand.

Most stands are designed so that the wiring is threaded through the stand itself or a loop-through style clamp so that the wiring is neatly bunched and not strung in such a way as to create a potential hazard to the user. (Some stands are portable and can be moved from one location to another.) Be sure all safety considerations are followed.

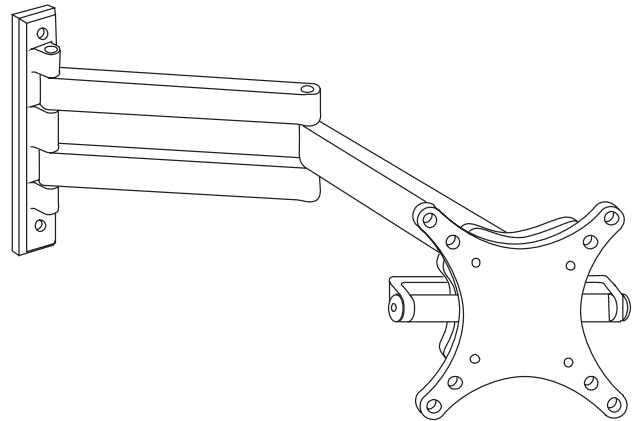

Typical Wall Stud Type Mount with Swivel Bracket

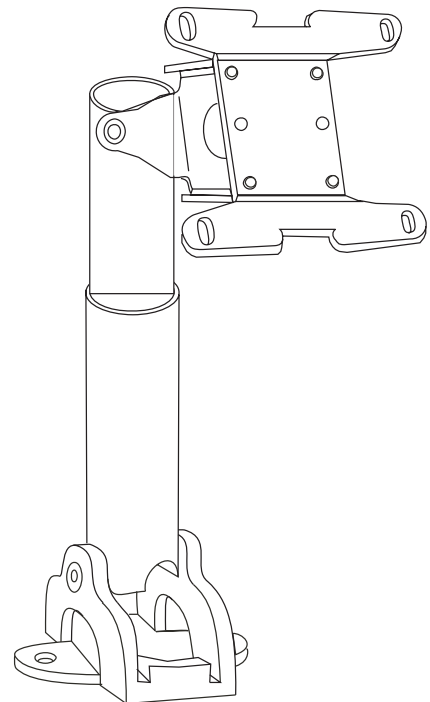

Typical Pedestal Type Mount with Swivel Bracket

General Troubleshooting (Some Quick and Easy Tips for Resolving Problems)

Installation

Symptom	Possible Cause(s)	Possible Solution(s)
Cannot direct enter channel number.	(TV in Pass-through Mode) Installer Menu item 028 CH. OVERRIDE is set to 0, i.e., disabled and/or Channel Access was denied in Express Script.	If the channel lineup is locked (recommended setting), only channels that are active in the TV's channel lineup can be selected. Set 028 CH. OVERRIDE to 1 to allow access for direct keypad entry to all channels.
	(TV in FTG Mode) The channel entered is not included in the FTG Channel Map.	Channel access is restricted to channels included in the FTG Channel Map. If necessary, make changes to the FTG Channel Map using the FTG File Manager or the FTG Device Configuration Application, as appropriate.
No channels present after Express Script.	Auto Tuning not run.	Refer to Express Script procedure. Auto Tuning must be run in order for the channel lineup to be populated. To reactivate the Express Script, restore the TV to a factory default condition.

Picture Reception and Sound

Symptom	Possible Cause(s)	Possible Solution(s)
No picture.	TV is turned OFF.	<ul style="list-style-type: none"> Turn TV ON. Power failure?
	Antenna/cable not connected.	Connect antenna/cable signal to TV.
	Connections incorrect.	Check connections on TV.
	MPI not connected.	If applicable, connect MPI cable to MPI device.
	Encrypted program.	Try another channel.
Normal picture, poor or no sound.	Wrong tuning band.	Adjust Installer Menu settings.
	Broadcast problem.	Try a different channel.
	Audio muted.	Press MUTE or use Volume Up key to increase sound level.
	Pillow/TV speaker not configured properly.	Check that Installer Menu items 020 FEATURE LEVEL and 027 HOSPITAL MODE are set as required. Also, if applicable, select TV Speaker in the Audio Menu.

Erratic Operation

Symptom	Possible Cause(s)	Possible Solution(s)
Installer Menu setup.	Wrong Installer Menu settings.	Adjust Installer Menu settings as required.

Installer Remote (not supplied with TV)

Symptom	Possible Cause(s)	Possible Solution(s)
Remote doesn't work.	Remote not in TV Mode.	Depending on the remote used, you may need to use a MODE key to put the remote into TV Mode.
	Not aimed at IR receiver.	Point remote at IR receiver on TV.
	Remote too far from IR receiver or IR path is obstructed.	Move remote closer to IR receiver on TV, darken room, and/or remove obstructions.
	MPI not connected.	If applicable, connect MPI cable to MPI device.
	Weak batteries.	Replace batteries.
	Wrong battery polarity.	Check that "+" and "-" match in battery compartment.
	Too much light in room.	Dim room light.
Remote IR codes do not match setting(s) in TV.	Make sure the Installer Remote is compatible. Contact your LG representative, as necessary. Then, check settings both in the TV and on the remote. IR codes sent by the remote must match the setting(s) in the TV.	

Troubleshooting (Cont.)

Commercial Mode Check / FTG Operation Troubleshooting

Commercial Mode Check

Use this flowchart to determine whether the TV is currently in Commercial Mode.

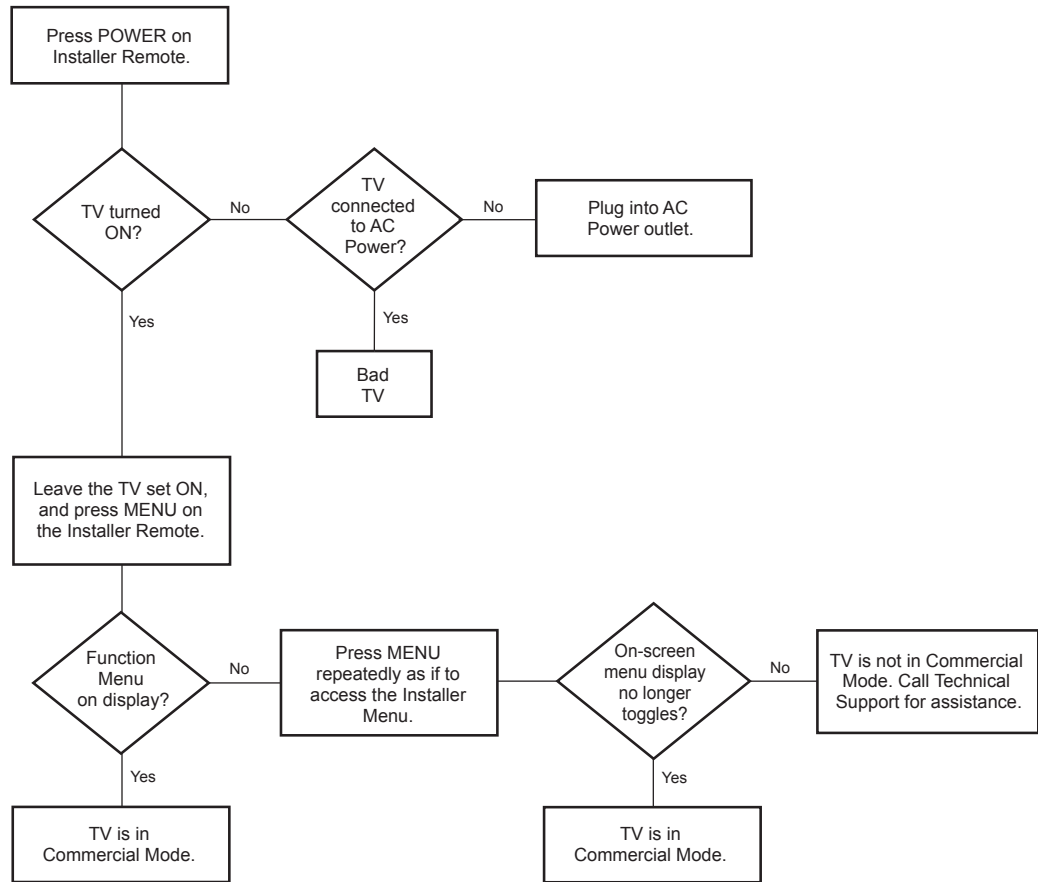

FTG Operation Troubleshooting

The following table provides troubleshooting information for when the EBL is configured for FTG Mode operation.

Symptom	Possible Cause(s)	Solution(s)
Communication Error ("Communications Timeout")	Cable(s) not connected.	Check and connect communication cables.
	TV not powered.	Check/connect the TV power cord.
	TV not turned ON.	TV needs to be turned ON (default setting of Installer Menu item 118 POWER SAVINGS).
	Wrong COM (communication) port.	In the FTG Device Configuration Application, select the correct COM port for the cable being used.

Troubleshooting (Cont.)

Channel Banks Setup Troubleshooting

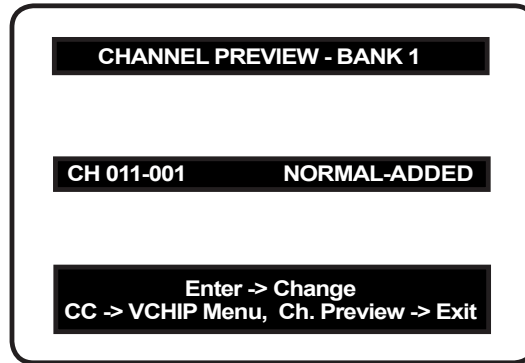

Channel Preview/Banks Setup Menu

Symptom	Possible Cause	Possible Solution
Cannot change channel status in menu.	Channel Access was denied in Express Script.	Set CH. OVERRIDE to 1 to allow access for channel status change. (Make sure to reset item 028 back to 0 when you are finished with channel banks setup.)
Channel Preview/Banks Setup Menu does not appear.	Express Script not completed.	The Channel Preview/Banks Setup Menu will not be available until the TV setup is transferred to the PTC. Also, set Installer Menu item 028 CH. OVERRIDE to 1 to allow access for channel status changes. (If applicable, make sure to reset item 028 back to 0 when you are finished with channel banks setup.)
Channel is blanked in all channel banks.	Blanking a channel in one channel bank will make it blank in all channel banks.	
Cannot tune in deleted channel on Channel Preview/Banks Setup Menu.		Select a channel bank where the deleted channel number is set to NORMAL-ADDED. Direct enter the deleted channel number. Change to the bank in which you want to activate the channel. Select "NORMAL-ADDED" on the Channel Preview/Banks Setup Menu.
"Inactive TV" message appears and then TV turns OFF.	TV is set up to display "Inactive TV" message if all channels are "NORMAL-DELETED" from Channel Bank 4.	Select another channel bank (1, 2, or 3) to return TV to normal operation.
Channel found during Auto Tuning does not tune in with Channel Up/Down.	Channel was deleted in currently selected channel bank.	If banks were set up, premium channels may only be available on another channel bank. Select the channel bank where the channel is set to NORMAL-ADDED. Or, direct enter channel number; then go to Channel Preview/Banks Setup Menu and select "NORMAL-ADDED."
When BANK on Installer Remote is pressed, TV shows Input List Menu.	Installer Menu item 027 HOSPITAL MODE is set to 0.	Set item 027 to appropriate setting for channel banks to appear with CH. BANK key presses.

Glossary of Terms

b-LAN

SONIFI Solutions, Inc. proprietary RF communication system used to configure/control TV via RF distribution system.

Channel Lineup

Channels set in the TV memory, via Auto Tuning/manual editing.

Cloning

The process of capturing a Master TV Setup and transferring it to a Target TV using a USB memory device.

Commercial Mode

A mode of operation that provides a broad range of commercial TV features based on control (settings) provided by the PTC and/or an MPI control device.

CPU

The TV's Central Processing Unit. Responsible for the presentation of video and audio from content received via the TV's tuner or Aux inputs.

EBL

Embedded *b-LAN* module. See also *b-LAN*.

E-Z Installation

Enables splash screen image, TV configuration, and software/firmware file downloads to selected TV models from a Pro:Centric server. Managed and administered via the Pro:Centric Admin Client.

Express Script

Hospital model TV configuration script that guides the installer through the process of setting up essential hospital model features for a typical viewing application.

EZ-Manager Wizard

Lodging/hospital model TV configuration wizard that provides configuration options for Pro:Centric operation as well as an option for using a USB memory device to configure a TV.

FTG Channel Map

Typically refers to a logical channel mapping of physical RF channels. This allows digital channels, like analog channels, to be tuned without requiring the dash key. Also, channels (analog or digital) can be arranged in any order that seems logical for customer tuning/viewing.

FTG Mode

LG commercial TV mode that enables decryption of Pro:Idiom encrypted channels and uses logical channel mapping. Implementation and TV operation is based on the "owner" of the FTG Logical Channel Map—the CPU or the EBL. LG's proprietary PC software is required for configuration.

Function Menu

Available via Installer Remote "MENU" key. Indicates the TV is not in Pass-through Mode. Restricts menu options to a subset of the TV setup menus, allowing users to retain functional control, while disabling setup options.

Installer Menu

Defines commercial TV functionality based on the parameters set.

LG Free-To-Guest (FTG)

Refers to a particular commercial mode of operation within an LG TV. See also FTG Mode.

Logical Channel Number

A number assigned to either a physical or virtual channel number in a Logical Channel Map.

Major Channel Number

Typically, the RF channel number assigned to a digital video stream.

Master TV

A TV whose Channel Map and Installer Menu and TV setup menu settings have been configured as a Master TV Setup for cloning purposes.

Minor Channel Number

A sub-channel or program number assigned to the content embedded in the digital video stream.

MPI

Multiple Protocol Interface. An MPI port or, for some TV models, an MPI card slot provides external control options for solution providers.

Pass-through Mode

The TV's factory default mode of operation. TVs can be configured for stand-alone use or as Master TVs for cloning purposes, and/or TVs may be controlled externally in this mode.

Physical Channel Number

The major channel number assigned to represent a specific 6 MHz RF band as specified by either the broadcast or CATV channel plan. See CEA (formerly EIA) or NCTA specifications for further information.

Pro:Centric Application

LG content delivery and communication interface that provides interactive entertainment, weather, amenities, etc. information for end users. (Powered by Pro:Centric server.)

Pro:Centric Admin Client

Web editor/content wizard provided for service provider and customer configuration of Pro:Centric application elements.

Pro:Idiom

Zenith proprietary security software that unlocks access to premium content to help assure rapid, broad deployment of HDTV and other high-value digital content.

PTC

Protocol Translator Card. The commercial controller (microprocessor) of the commercial TV.

Target TV

A TV to which a Master TV Setup will be transferred.

TV Setup Menus

Available via Installer Remote "MENU" key in Pass-through Mode only. Menus provide access to setup and functional features of the TV.

USB Memory Device

A USB flash drive or USB storage device, etc. that can be used for TV configuration purposes (typically cloning or FTG Mode via CPU configuration) or for updating TV software.

Virtual Channel Number

An alias (virtual) channel number provided in the data stream, by the broadcaster, of a digital broadcast channel to be displayed by consumer TVs in place of the physical channel number. The major number is the same as the original analog channel number and the minor number is the nth program available in that digital video stream.

Document Revision History / Open Source Software Notice

Document Revision History

Date	Description
January 2015	Revision A: New document
January 2015	Revision B: Installer Menu update
January 2015	Revision C: Title page update

Product documentation is available online at: www.LGolutions.com.

Open Source Software Notice

To obtain the source code under GPL, LGPL, MPL and other open source licenses, that is contained in this product, please visit <http://opensource.lge.com>. In addition to the source code, all referenced license terms, warranty disclaimers and copyright notices are available for download. LG Electronics will also provide open source code to you on CD-ROM for a charge covering the cost of performing such distribution (such as the cost of media, shipping and handling) upon e-mail request to opensource@lge.com. This offer is valid for three (3) years from the date on which you purchased the product.



For Customer Support/Service, please call:

1-888-865-3026

www.LGsolutions.com

Pro:Idiom is a registered trademark of Zenith Electronics LLC. Pro:Centric and Smart Share are registered trademarks of LG Electronics Inc. *b*-LAN is a trademark of SONIFI Solutions, Inc. DLNA Certified is a registered trademark of Digital Living Network Alliance. Intel is a registered trademark of Intel Corporation in the U.S. and/or other countries. Wi-Fi Direct and Miracast are registered trademarks of Wi-Fi Alliance. All other trademarks or registered trademarks are the property of their respective owners.

© Copyright 2015 LG Electronics U.S.A., Inc.

206-4271
Revision C

Free Manuals Download Website

<http://myh66.com>

<http://usermanuals.us>

<http://www.somanuals.com>

<http://www.4manuals.cc>

<http://www.manual-lib.com>

<http://www.404manual.com>

<http://www.luxmanual.com>

<http://aubethermostatmanual.com>

Golf course search by state

<http://golfingnear.com>

Email search by domain

<http://emailbydomain.com>

Auto manuals search

<http://auto.somanuals.com>

TV manuals search

<http://tv.somanuals.com>