

AP_LX-M150A(ENG)_112S



MICRO HI-FI SYSTEM OWNER'S MANUAL

MODEL: LX-M150

(LX-M150A/D/X , LXS-M150)

**Please read this manual carefully before operating your set.
Retain it for future reference.**

**Designs and specifications are subject to change without
notice for improvement.**



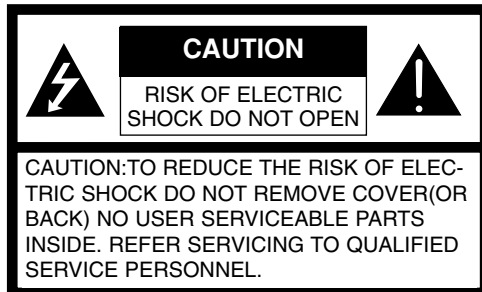

Explanation Graphical Symbols:



The lightning flash with arrowhead symbol, within an equilateral triangle is intended to alert the user to the presence of uninsulated dangerous voltage within the product's enclosure that may be of sufficient magnitude to constitute a risk of electric shock to persons.



The exclamation point within an equilateral triangle is intended to alert the user to the presence of important operating and maintenance (servicing) instructions in the literature accompanying the appliance.

WARNING

TO REDUCE THE RISK OF FIRE OF ELECTRIC SHOCK, DO NOT EXPOSE THIS APPLIANCE TO RAIN OR MOISTURE.

To avoid electrical shock, do not open the cabinet, Refer servicing to qualified personnel only.

The apparatus shall not be exposed to dripping or splashing and that no objects filled with liquids, such as vases, shall be placed on the apparatus.

Warning: Do not install this equipment in a confined space such as a book case or similar unit.

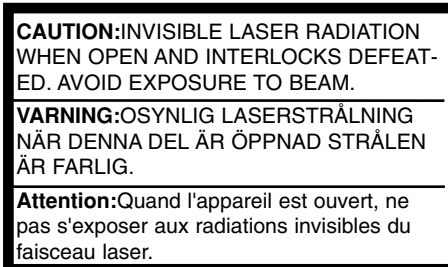

This label is located on the interior.

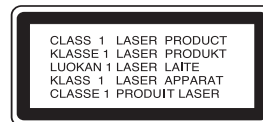

This Compact Disc player is classified as a CLASS 1 LASER product.

The CLASS 1 LASER PRODUCT label is located on the exterior.

CAUTION

Use of controls or adjustments or performance of procedures other than those specified here-in may result in hazardous radiation exposure.

Laser component in this product is capable of emitting radiation exceeding the limit for Class 1.

CAUTION concerning the Power Cord

Most appliances recommend they be placed upon a dedicated circuit;

That is, a single outlet circuit which powers only that appliance and has no additional outlets or branch circuits. Check the specification page of this owner's manual to be certain.

Do not overload wall outlets. Overloaded wall outlets, loose or damaged wall outlets, extension cords, frayed power cords, or damaged or cracked wire insulation are dangerous. Any of these conditions could result in electric shock or fire. Periodically examine the cord of your appliance, and if its appearance indicates damage or deterioration, unplug it, discontinue use of the appliance, and have the cord replaced with an exact replacement part by an authorized servicer.

Protect the power cord from physical or mechanical abuse, such as being twisted, kinked, pinched, closed in a door, or walked upon. Pay particular attention to plugs, wall outlets, and the point where the cord exits the appliance.



2

Contents

1 Introduction	4	Recording	14
About the Symbols for instructions	4	Basic Setting	14
Notes on Tapes	4	Recording from Radio,CD or Auxiliary source	14
Notes on Discs	4	CD to Tape Synchronized Recording	14
Handling discs	4	CD Playback	15-16
Storing discs	4	Basic Playback	15
Cleaning discs	4	To Pause Play Back	15
Adjusting the voltage - OPTIONAL	4	To Stop Play	15
Front / Rear Panel	5	To Skipping the Track	15
Remote Control	6	To Play Fast Rewind or Fast Forward.	15
Remote Control battery installation	6	To Repeat Play	15
Remote Control Operation Range	6	To check the MP3 file information	15
Display Window	7	To Program Play	16
2 Installation	8	About MP3	16
Speaker System Connection	8	4 Maintenance and Service	17
Antenna (Aerial) Connections	8	Troubleshooting	17
Auxiliary Function	9	5 Reference	18
Audio Adjustment	9	Specifications	18
Volume Adjustment	9		
XDSS (Extreme Dynamic Sound System)	9		
MUTE	9		
Sound Quality Adjustment	9		
3 Operation	10-13		
Setting the Clock	10		
Sleep Function	10		
Timer Function	11		
RDS Function - OPTIONAL	12		
About RDS	12		
RDS Tuning	12		
RDS Display Options	12		
Programme Search (PTY)	12		
Presetting the Radio Stations	13		
Listening to the Radio	13		
Tape Playback	14		
Basic Playback	14		
To Stop Play	14		
To Pause Play	14		
To Play Rewind or Fast Forward	14		
Auto Stop Deck	14		

1. Introduction

About the symbols for instructions

-  Indicates hazards likely to cause harm to the unit itself or other material damage.
-  Indicates special operating features of this unit.

Notes on Tapes

Preventing overwriting a recording

Removing the tab(s) of the cassette (with a small screwdriver) will prevent accidental erasure.

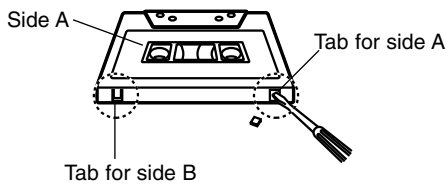

To record again, cover the hole of the tab with adhesive tape.

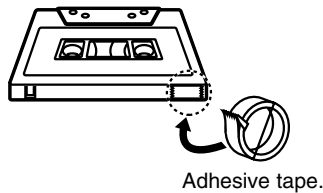

Notes on Discs

Handling discs

Do not touch the playback side of the disc. Hold the disc by the edges so that fingerprints do not get on the surface. Never stick paper or tape on the disc.

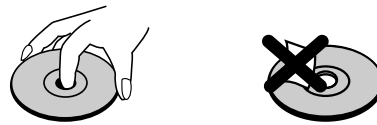

Storing discs

After playing, store the disc in its case. Do not expose the disc to direct sunlight or sources of heat and never leave it in a parked car exposed to direct sunlight.

Cleaning discs

Fingerprints and dust on the disc can cause poor picture quality and sound distortion. Before playing, clean the disc with a clean cloth. Wipe the disc from the center out.

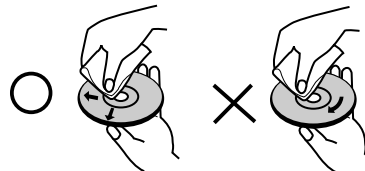

Do not use strong solvents such as alcohol, benzene, thinner, commercially available cleaners, or anti-static spray intended for older vinyl records.

Adjusting the voltage - OPTIONAL

If your unit is equipped with a voltage selector at the back side, be sure to set it to your local power supplied before connecting the AC power cord.

Front / Rear Panel

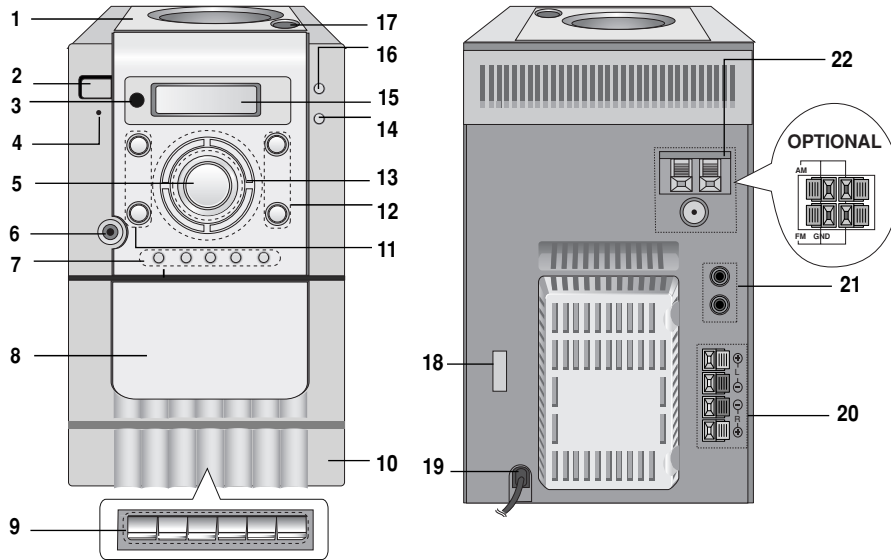

- | | |
|---|---|
| <ol style="list-style-type: none"> 1. CD DOOR▲ 2. POWER (⏻STANDBY/ON) button 3. Remote Control Sensor 4. POWER indicator 5. VOLUME CONTROL KNOB 6. HEADPHONE SOCKET (🎧 PHONE):
∅3.5mm 7. • CLOCK button
• TIMER button
• REPEAT button
• PROGRAM/MEMORY button
• STOP/CLEAR button 8. CASSETTE Holder 9. • RECORD (●) button - TAPE
• PLAY (▶) button - TAPE
• REWIND (◀◀) button - TAPE
• FAST FORWARD (▶▶) button - TAPE
• STOP/EJECT(■/▲) button - TAPE
• PAUSE(⏸) button -TAPE 10. TAPE button DOOR | <ol style="list-style-type: none"> 11. • CD PLAY/PAUSE (CD▶/⏸) button
• PRESET (+/-) buttons 12. • CD SKIP/SEARCH (◀◀◀/▶▶▶▶) buttons
• TUNING (+/-) buttons -TUNER 13. • FUNCTION SELECT (FUNCTION) button
(TUNER/ CD/ TAPE /AUX)
• TUNER/BAND button
• RDS (OPTIONAL)/SET button
• MODE/RIF button 14. EQUALIZER PATTERN (EQ) button 15. DISPLAY 16. XDSS button 17. CD OPEN/CLOSE(▲) (OPEN/CLOSE) button 18. VOLTAGE SELECT SWITCH : OPTIONAL 19. POWER CORD 20. SPEAKER TERMINAL 21. AUXILIARY INPUT SOCKET (AUX) 22. ANTENNA TERMINAL |
|---|---|

Introduction

Remote control

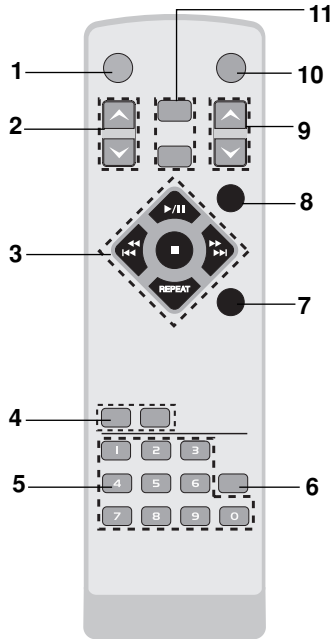

1. POWER button
2. PRESET (V/A) buttons
3. CD FUNCTION buttons
 - CD PLAY/ PAUSE (▶/||) buttons
 - CD STOP(■) button
 - CD SKIP/SEARCH (◀◀◀/▶▶▶) buttons
 - REPEAT button
4. • EQUALIZER PATTERN (EQ PATT.) button
- XDSS button
5. NUMBER buttons
6. MP3 file information display (MP3 Info) button
7. PROGRAM button
8. SLEEP button
9. VOLUME CONTROL (V/A) buttons
10. MUTE button
11. • TUNER/BAND button
- AUX button

Remote control battery installation

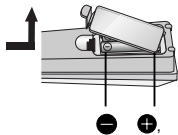

Detach the battery cover on the rear of the remote control, and insert two R03 (size AAA) batteries with + and - aligned correctly.

⚠ Caution: Do not mix old and new batteries. Never mix different types of batteries (standard, alkaline, etc.).

Remote Control Operation Range

Point the remote control at the remote sensor and press the buttons.

- Distance: About 23 ft (7 m) from the front of the remote sensor.
- Angle: About 30° in each direction of the front of the remote sensor.

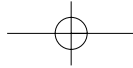

Display Window

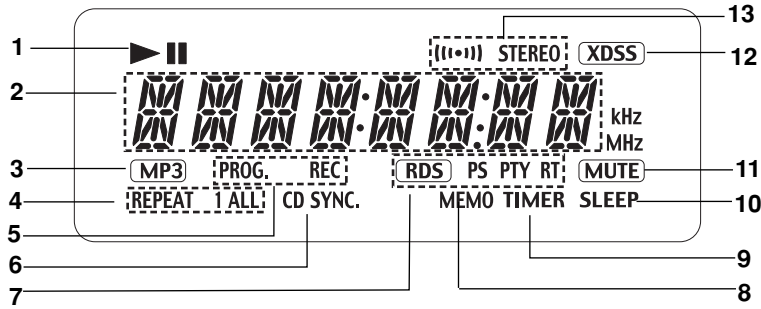

- | | |
|-----------------------------------|---------------------------------|
| 1. PLAY/ PAUSE indicator | 8. MEMO. indicator |
| 2. FUNCTION indicators | 9. TIMER indicator |
| 3. MP3 indicator | 10. SLEEP indicator |
| 4. CD REPEAT indicator | 11. MUTE indicator |
| 5. • PROGRAM indicator | 12. XDSS indicator |
| 6. CD SYNCHRO RECORDING indicator | 13. • FM STEREO indicator |
| 7. RDS indicator : OPTIONAL | • FM STEREO RECEIVING indicator |

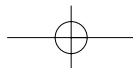
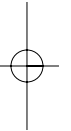
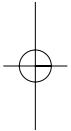

2. Installation

Speaker System Connection

Connect the speaker cords to the speaker terminals.

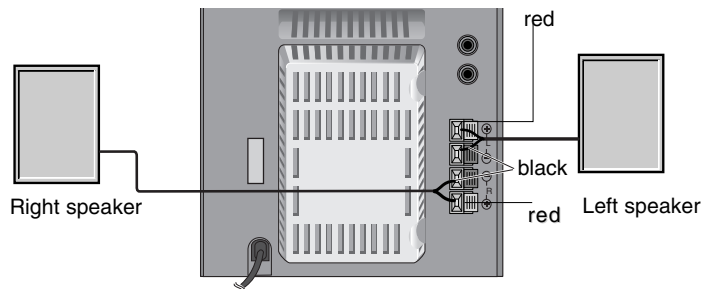

Notes

- Be sure to match the speaker cord to the appropriate terminal on the components: + to + and - to -. If the cords are reversed, the sound will be distorted and will lack base.
- If you use front speakers with low maximum input rating, adjust the volume carefully to avoid excessive output on the speakers.
- Do not disassemble the front cover of supplied speaker.

Antenna (Aerial) Connections

Connect the supplied FM/AM antennas for listening to the radio.

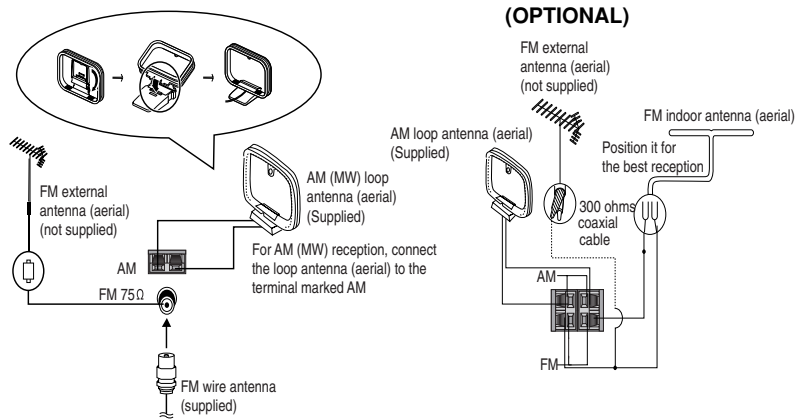

Notes

- To prevent noise pickup, keep the AM loop antenna away from the unit and other components.
- Be sure to fully extend the FM wire antenna.
- After connecting the FM wire antenna, keep it as horizontal as possible.

Auxiliary Function

1. Connect an auxiliary device i.e. TV or VCR, via the rear mounted AUX phone sockets.
2. Press AUX.

Note

You can also record from the auxiliary input source, see Recording Section.

Audio Adjustment

Volume Adjustment

- Turn VOLUME CONTROL KNOB clockwise to increase the sound level, or counterclockwise to decrease it on the front panel.
- Press VOLUME CONTROL (▲) to increase the sound level, or press the VOLUME CONTROL (▼) to decrease it on the remote control.

XDSS (Extreme Dynamic Sound System)

Press XDSS to reinforce treble, bass and the surround effect. The "XDSS ON" or "XDSS OFF" indicator lights. To cancel, press XDSS again.

MUTE

Press MUTE to mute your unit. You can mute your unit in order, for example, to answer the telephone, "MUTE" indicator flashes in the display window.

Sound Quality Adjustment

• To activate stereo sound

You can choose between 4 fixed sound impressions.

Select a desired sound mode by using the EQ button.

FLAT : linear frequency response

ROCK : more bass, more treble

POP : less bass, less treble

CLASSIC: for orchestral music

• Headphone Socket

Connect a stereo headphone plug (∅ 3.5mm) into the headphone jack.

The speakers are automatically disconnected when you plug in the headphone.(not supplied)

Installation

3.Operation

Setting the Clock

1. Press CLOCK.
(If the clock requires setting, press and hold CLOCK for more than 2 seconds.)
- The hours begin to flash.
2. Select a 12 hour cycle or 24 hour cycle by pressing TUNING (+/-) on the front panel.

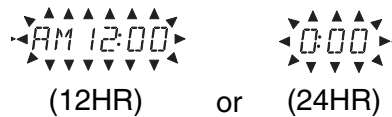

3. Press SET to confirm the selected hour cycle.
4. Use TUNING (+/-) buttons to set the correct hours on the front panel.
5. Press SET.
6. Use TUNING (+/-) buttons to set the correct minutes on the front panel.
7. Press SET and the correct time is shown on the display.
8. Press CLOCK at any time to display the time for about 3 seconds.

Note

The unit can also set the clock function in power off state.

Sleep Function

When the sleep timer is used, the power is automatically turned off after the specified time has elapsed.

1. To specify the time delay before the power is turned off, press SLEEP.
In the display window you can see *SLEEP 90* for about 5 seconds.
This means that the system turns off automatically after 90 minutes.
Each time the button is pressed the time interval before it turns off is reduced by 10 minutes. i.e. 80...70... etc.
Select the desired time to turn off.
2. To check the remaining time until the power is turned off.
While the sleep function is active press SLEEP briefly. The time remaining until it turns off is displayed for about 5 seconds.

Note

If you press SLEEP while the sleep time is displayed, the SLEEP time is reset.

To cancel the sleep timer mode

If you wish to stop the function, press the SLEEP button repeatedly until "SLEEP 10" appears, and then press SLEEP once again while "SLEEP 10" is displayed.

Timer Function

With the TIMER function you can have the radio reception and CD play turned on and off at the time desired.

1. Press CLOCK to check the current time.

For your reference

If you don't set clock, timer function doesn't work.

2. Press TIMER to enter the time setting mode.
TUNER-CD flashes in the display window in turn.

For your reference

If you want to correct the previous memorized TIMER setting, press and hold the TIMER button more than 2 seconds.

- The previous memorized timer on time and "TIMER" indicators appear in the display.
3. Press SET when the desired function is flashing.
 - 4.1. When you select the TUNER function, Select the previous memorized preset number with PRESET (+/-) on the front panel and press SET.
 - "ON TIME" indicator appears for about 0.5 seconds in the display window and then disappears.
 2. When you select the CD function,
 - "ON TIME" indicator appears for about 0.5 seconds in the display window and then disappears.
 5. Set the hour to switch on by pressing TUNING (+/-) buttons on the front panel.
 6. Press SET to confirm the hour to switch on.
 7. Set the minute to switch on by pressing TUNING (+/-) buttons on the front panel.
 8. Press SET to confirm the minute to switch on.
 9. Set the hour to switch off by pressing TUNING (+/-) buttons on the front panel.

10. Press SET to confirm the hour to switch off.

11. Set the minute to switch off by pressing TUNING (+/-) buttons on the front panel.

12. Press SET.

13. Adjust the volume level by pressing TUNING (+/-) buttons on the front panel.

14. Press SET.

"TIMER" appears in the display window and the time setting has been completed.

15. Switch the system off.

The selected function is automatically switched on and off at the time set.

To cancel or check the timer

Each time the TIMER button is pressed you can select the time set or cancel. You can also check the time setting status.

To activate or check the time, press the TIMER button so that "TIMER" appears in the display window.

To cancel the TIMER, press the TIMER button so that "TIMER" disappears in the display window.

Note

The unit can also set the clock function in power off state.

RDS Function - OPTIONAL

About RDS

This unit is equipped with RDS (Radio Data System), which brings a wide range of information to FM radio. Now in use in many countries, RDS is a system for transmitting station call signs or network information, a description of station programme type text message about the station or specifics of musical selection and the correct time.

RDS Tuning

When a FM station is tuned in and it contains RDS data, the unit will automatically display the station's call sign and the RDS indicator will light in the Display Window as well as indicators for the programme type recognition (PTY), Radio Text (RT), Clock Time (CT) and RDS services programme (PS) if transmitted by the station.

RDS Display Options

The RDS system is capable of transmitting a wide variety of information in addition to the initial call sign that appears when a station is first tuned. In normal RDS operation the display will indicate the station name, broadcast network or call letters. Pressing RDS on the front panel enables you to cycle through the various data types in the sequence:

(PS → FREQUENCY → PTY → RT → CT)

- PTY (Programme type recognition)- The name of the programme type is shown in the Display Window.
- RT (Radio text recognition)- The name of the radio text is shown in the Display Window.
- CT (Time controlled by the channel)- Enables the unit to receive the actual time and show it in the Display Window.
- PS (Programme Service name)- The name of the channel is shown in the Display Window.

Note

Some RDS stations may not choose to include some of these additional features. If the data required for the selected mode is not being transmitted, the Display Window will show a PTY NONE, RT NONE, CT NONE, PS NONE message.

Programme Search (PTY)

A major benefit of RDS is its ability to encode broadcasts with Programme Type (PTY) codes that indicate the type of material being broadcast. The following list shows the abbreviations used to indicate each PTY along with an explanation of the PTY.

NEWS	News
AFFAIRS	Current Affairs
INFO	Information
SPORT	Sports
EDUCATE	Educational
DRAMA	Drama
CULTURE	Culture
SCIENCE	Science
VARIED	Varied Speech Programme
POP M	Popular Music
ROCK M	Rock Music
EASY M	Easy Listening Music
LIGHT M	Classical Music
CLASSICS	Serious Classical Music
OTHER M	Other Music
WEATHER	Weather Information
FINANCE	Financial Programmes
CHILDREN	Children's Programmes
SOCIAL	Social Affairs Programmes
RELIGION	Religious Broadcasts
PHONE IN	Phone-In Programmes
TRAVEL	Travel and Touring
LEISURE	Leisure and Hobby
JAZZ	Jazz Music
COUNTRY	Country Music
NATION M	National Music
OLDIES	Oldies Music
FOLK M	Folk Music
DOCUMENT	Documentary Programmes
TEST	Station Alarm Test Message
ALARM 1	Emergency Broadcast Information

You may search for a specific Programme Type (PTY) by following these steps:

1. Press TUNER/BAND to select FM mode.
2. Select a desired station by pressing TUNING (+/-). When the RDS transmission is received, the display shows the program service name (PS) after RDS indicator appears.
3. Press the RDS to select PTY mode.
4. To search for a different PTY, press the PRESET (+/-) while the last PTY in use is still displayed to scroll through the list of available PTY types.
5. When the PTY is selected, press the (◀◀◀◀/▶▶▶▶) within 5 seconds. The unit will go into an automatic search mode and attempt to find the next station with acceptable signal strength that matches the desired PTY type.

Presetting the Radio Stations

You can preset 50 stations for FM and AM. Before tuning, make sure that you have turned down the volume to the minimum.

1. Press TUNER/BAND to select the FM or AM you want in the display window. Every time you press TUNER/BAND, FM and AM changes alternately.
2. Press TUNING (+/-) on the front panel until the frequency indication starts to change, then release. Scanning stops when the unit tunes in a station.

Notes

- Tuning in automatically
Press TUNING (+/-) for more than 0.5 seconds.
 - Tuning in manually
Press TUNING (+/-) briefly and repeatedly.
3. Press PROGRAM/MEMO. on the front panel
A preset number will flash in the display window.
 4. Press PRESET (+/-) (or PRESET (▼/▲) on the remote control) to select the preset number you want.
 5. Press PROGRAM/MEMO.
The station is stored.
 6. Repeat steps 3 to 6 to store other stations.

To clear all the memorized stations

Press and hold PROGRAM/MEMO. on the front panel for about two seconds, "CLEAR" appears in the display window and then press CLEAR, the stations are cleared.

For your reference

If all stations have already been entered, FULL message will appear in the display window for a moment and then a preset number will flash. To change the preset number, follow the steps 5-6.

To recall presets

Press and hold PRESET (+/-) (or PRESET (▼/▲) on the remote control) until the desired preset number appears or press it repeatedly.

Listening to the radio

1. Press TUNER/BAND to select the FM or AM you want in the display window. The last received station is tuned in.
2. Press PRESET (+/-) (or PRESET (▼/▲) on the remote control) repeatedly to select the preset station you want.
 - Each time you press the button, the unit tunes in one preset station at a time.
3. Adjust the volume by pressing VOLUME CONTROL KNOB on the front panel or VOLUME (▼/▲) on the remote control repeatedly.

To listen to non-preset radio stations

- Use manual or automatic tuning in step 2.
- For automatic tuning, press and hold TUNING (+/-) on the front panel.

To turn off the radio

Press POWER to turn the unit off or select another function mode (CD, TAPE or AUX).

For your reference

- If an FM program is noisy
Press MODE/RIF so that "STEREO" disappears in the display window. There will be no stereo effect, but the reception will improve. Press MODE/RIF again to restore the stereo effect.
- To improve reception Reposition the supplied antennas.

Notes

- Use MODE/RIF (Radio Interference Filter) function to switch to MONO reception if stereo reception is distorted by noise.
- When recording the MW(AM) broadcast, beat noises may occur. If it does, press MODE/RIF once.

Tape Playback

Basic Playback

1. Press FUNCTION repeatedly to appear TAPE indicator.
2. Open cassette deck by pushing STOP/EJECT (■/▲) button.
3. Insert a cassette with the tape side to the bottom and then close deck.
4. Press PLAY (▶).

To Stop Play

Press STOP/EJECT (■/▲) during playback.

To Pause Play

Press PAUSE (⏸) during playback. Press this button again it to resume play.

To Play Fast Rewind or Fast Forward

After pressing REWIND/FAST FORWARD (◀◀/▶▶) on the front panel during playback or stopping.

AUTO STOP DECK

After auto stop deck plays only front side, the unit stops automatically.

Recording

Wind the tape to the point recording starts. (Use only normal tapes.)

Basic Setting

1. Select the function (MP3/CD, TUNER/BAND or AUX) you want to record.
2. Open the cassette deck and insert a blank cassette into the cassette compartment.

Recording from Radio, CD or Auxiliary source

1. Press FUNCTION button to select desired recording source, and then press RECORD (●) button. The recording begins.

For your reference

When you press RECORD (●) button, PLAY (▶) button is pressed automatically.

2. To pause recording
Press PAUSE (⏸) button during recording. Press PAUSE (⏸) button again to resume recording.
3. To stop recording
Press STOP/EJECT (■/▲).

CD to Tape Synchronized Recording

The CD synchro recording function dubs a complete CD and programmed titles automatically into a cassette.

1. When you select CD function, press RECORD (●) button. "REC" appears and "CD SYNC" displays in the display window.
2. The synchronized recording is started automatically after about 8 seconds.

Notes

- If you wish to record from the desired track, select the desired track with CD SKIP/SEARCH (◀◀◀/▶▶▶) before commencing CD synchro recording.
- The function change is not possible during recording.

CD Playback

Basic Playback

1. Press FUNCTION repeatedly to appear CD indicator.
If no disc is loaded then "NO DISC" is displayed.
2. Press CD OPEN/CLOSE (▲ OPEN/CLOSE) and place the disc into the disc tray.

Note

To load an 8cm(3 inch) disc, put it onto the inner circle of the tray.

3. Press CD OPEN/CLOSE (▲ OPEN/ CLOSE) to close the disc compartment.
Audio CD: "READING" appears in the display window, and then the total number of tracks and the playing time are displayed.
MP3 CD: "READING" appears in the display window, and then the total number of files is displayed.
4. Press CD PLAY/ PAUSE (▶/||).

To Pause Play

Press CD PLAY/ PAUSE (▶/||) during playback. Press this button again it to resume play.

To Stop Play

Press CD STOP (■) during playback.

To Skipping the Track

- Press the CD SKIP/SEARCH (▶▶▶▶) button to go to the next track.
- When the CD SKIP/SEARCH (◀◀◀◀) button is pressed once midway through a track, the player returns to the start of that track. When it is pressed again, a track is skipped each time the button is pressed.

To Play Fast Rewind or Fast Forward

After pressing CD SKIP/SEARCH (◀◀◀◀/▶▶▶▶) buttons for more the 2 seconds on the front panel, then release during playback,press PLAY (▶/||) at the point you want.

Note

This function is not available to play a MP3 file.

To Repeat Play

To play one track repeatedly

Press REPEAT once during playback.
- "REPEAT 1" appears in the display.

To play all tracks repeatedly

Press REPEAT again during playback.
- "REPEAT ALL" appears in the display.

To cancel repeat play

Press REPEAT once more during playback.
- "Repeat indicator" disappears.

To check MP3 file information

Press the MP3 Info button during MP3 file playback.

- The information (Title, Artist or Album) of the MP3 file will be shown in the display window.
- If there is no information of the MP3 file, "NO ID3 TAG" indicator will be shown in the display window.
- The "MP3 file name" and "ID3 TAG" should be named using English.

Note

This unit can play a CD-R or CD-RW that contains audio titles or MP3 files.

To Program Play

You can arrange the order of the tracks on the discs and create your own program. The program can contain up to 20 tracks.

1. Press PROGRAM/MEMO. (or PROGRAM on the remote control) on the stop mode.
2. Press CD SKIP/SEARCH (◀◀◀/▶▶▶▶) buttons to select the track you want.
3. Press PROGRAM/MEMO. (or PROGRAM on the remote control).
4. Repeat 1~3.
5. Press CD PLAY/ PAUSE (▶/||).

To check program contents

Press PROGRAM/MEMO. (or PROGRAM on the remote control) on the stop mode.

- A track and program number will be displayed.

To clear program contents

Press PROGRAM/MEMO. (or PROGRAM on the remote control) on the stop mode. And then press STOP/CLEAR on the front panel or STOP(■) on the remote control.

To add program contents

1. Press PROGRAM/MEMO. (or PROGRAM on the remote control) repeatedly on the program stop mode until "Track Number" blinks.
2. Repeat 2~5.

To modify program contents

1. Press the PROGRAM/MEMO. (or PROGRAM on the remote control) to display program number you want to modify.
2. Repeat 2~4.

About MP3

- An MP3 file is audio data compressed by using the MPEG1 audio layer-3 file-coding scheme. We call files that have the ".mp3" file extension "MP3 files".
- The unit can not read an MP3 file that has not ".mp3" file extension.

MP3 Disc compatibility with this unit is limited as follows:

1. Sampling Frequency / 8 - 48kHz
2. Bit rate / 8 - 320kbps
3. CD-R physical format should be "ISO 9660"
4. If you record MP3 files using the software which cannot create a FILE SYSTEM, for example "Direct-CD" etc., it is impossible to playback MP3 files. We recommend that you use "Easy-CD Creator", which creates an ISO9660 file system.
5. File names should be named using 30 letters or less and must incorporate ".mp3" extension e.g. "*****.MP3".
6. Do not use special letters such as "/ : * ? " < > " etc.
7. Even if the total number of files on the disc have more than 1000, it will only be shown up to 999.

About MULTI SESSION

- This function recognizes the multi session disc according to a disc of CD-ROM type.
- ex) If there are MP3 files in the first session, the MP3 file in the first session is only played. If there are only MP3 files in the whole session, all of the MP3 files in the session are played. If there is Audio CD in the first session, only the Audio CD in the first session is played.

4. Maintenance and Service

Troubleshooting

Symptom	Cause	Correction
No power.	<ul style="list-style-type: none"> The power cord is disconnected. 	<ul style="list-style-type: none"> Plug the power cord into the wall outlet securely.
No sound.	<ul style="list-style-type: none"> The audio cables are not connected securely. 	<ul style="list-style-type: none"> Connect the audio cable into the jacks securely.
	<ul style="list-style-type: none"> The power of the external source equipment is switched off. 	<ul style="list-style-type: none"> Switch on the external source equipment.
The unit does not start playback.	<ul style="list-style-type: none"> No disc or tape is inserted. 	<ul style="list-style-type: none"> Insert a disc or tape.
	<ul style="list-style-type: none"> An unplayable disc or tape is inserted. 	<ul style="list-style-type: none"> Insert a playable disc or tape.
	<ul style="list-style-type: none"> The disc is placed upside down. 	<ul style="list-style-type: none"> Place the disc with the playback side down.
	<ul style="list-style-type: none"> The disc is not placed within the guide. 	<ul style="list-style-type: none"> Place the disc on the disc tray correctly inside the guide.
	<ul style="list-style-type: none"> The disc is dirty. 	<ul style="list-style-type: none"> Clean the disc.
The remote control does not work properly.	<ul style="list-style-type: none"> The remote control is not pointed at the remote sensor of the unit. 	<ul style="list-style-type: none"> Point the remote control at the remote sensor of the unit.
	<ul style="list-style-type: none"> The remote control is too far from the unit. 	<ul style="list-style-type: none"> Operate the remote control within about 23 ft (7 m).
	<ul style="list-style-type: none"> There is an obstacle in the path of the remote control and the unit. 	<ul style="list-style-type: none"> Remove the obstacle.
	<ul style="list-style-type: none"> The batteries in the remote control are exhausted. 	<ul style="list-style-type: none"> Replace the batteries with new ones.

5. Reference

Specifications

[General]	Power supply	Refer to the back panel of the unit.	
	Power consumption	20W	
	Mass	3kg	
	External dimensions (WxHxD)	146 X 238 X 251mm	
[CD]	Frequency response	40 - 18000 Hz	
	Signal-to-noise ratio	60 dB	
	Dynamic range	60 dB	
[Tuner]	FM	Tuning Range	87.5 - 108.0 MHz or 65 - 74 MHz, 87.5 - 108.0 MHz
		Intermediate Frequency	10.7 MHz
		Signal to Noise Ratio	55/50 dB(MONO/STEREO)
		Frequency Response	60 - 10000 Hz
	AM (MW)	Tuning Range	522 - 1611 kHz or 530 - 1610 kHz
		Intermediate Frequency	450 kHz
		Signal to Noise Ratio	35 dB
		Frequency Response	100 - 1800 Hz
[Amp]	Output Power	5W + 5W	
	T.H.D	0.5%	
	Frequency Response	60 - 20000 Hz	
	Signal-to-noise ratio	60 dB	
[TAPE]	Tape Speed	4.75 Cm/sec	
	Wow Flutter	0.3% (MTT -111, JIS-WTD)	
	F.F/REW Time	120sec (C-60)	
	Frequency Response	250 - 8000Hz	
	Signal to Noise Ratio	40dB(P/B)/38db(R/P)	
	Channel Separation	32dB(P/B)/30dB(R/P)	
	Erase Ratio	50dB (MTT-5511)	
[Speakers]	Type	1 Way 1 Speaker	
	Impedance	4 Ω	
	Frequency Response	100 - 18000 Hz	
	Sound Pressure Level	88 dB/W (1m)	
	Rated Input Power	5W	
	Max. Input Power	10W	
	Net Dimensions (WxHxD)	148 x 238 x 183mm	
	Net Weight (1EA)	1.4kg	

Designs and specifications are subject to change without notice.

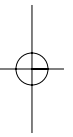
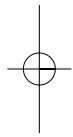
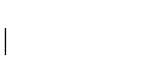
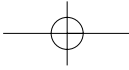

P/NO : 3834RH0112S

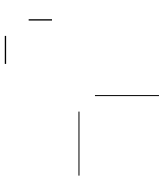
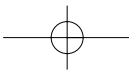
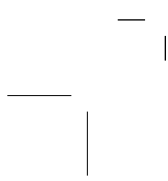

Free Manuals Download Website

<http://myh66.com>

<http://usermanuals.us>

<http://www.somanuals.com>

<http://www.4manuals.cc>

<http://www.manual-lib.com>

<http://www.404manual.com>

<http://www.luxmanual.com>

<http://aubethermostatmanual.com>

Golf course search by state

<http://golfingnear.com>

Email search by domain

<http://emailbydomain.com>

Auto manuals search

<http://auto.somanuals.com>

TV manuals search

<http://tv.somanuals.com>