

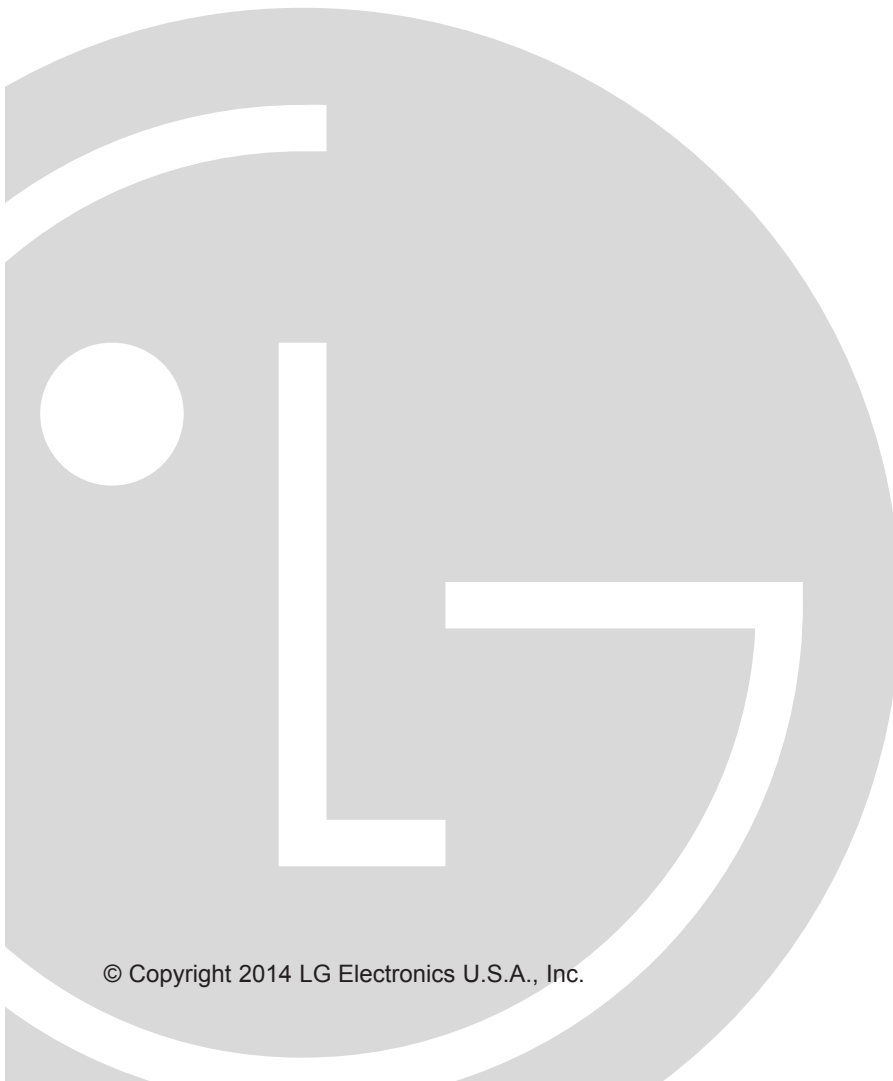

CodePlus™ OAT100R Off Air Transcoder System

Installation & Setup Guide Warranty







© Copyright 2014 LG Electronics U.S.A., Inc.

P/N: 206-4218 (Rev D)

For Customer Support/Service, please call: **1-888-865-3026**

The latest product information and documentation is available online at:
www.LG solutions.com

	WARNING RISK OF ELECTRIC SHOCK DO NOT OPEN	
WARNING: TO REDUCE THE RISK OF ELECTRIC SHOCK DO NOT REMOVE COVER (OR BACK). NO USER-SERVICEABLE PARTS INSIDE. REFER TO QUALIFIED SERVICE PERSONNEL.		
	The lightning flash with arrowhead symbol, within an equilateral triangle, is intended to alert the user to the presence of uninsulated "dangerous voltage" within the product's enclosure that may be of sufficient magnitude to constitute a risk of electric shock to persons.	
	The exclamation point within an equilateral triangle is intended to alert the user to the presence of important operating and maintenance (servicing) instructions in the literature accompanying the appliance.	

WARNING:

TO PREVENT FIRE OR SHOCK HAZARDS, DO NOT EXPOSE THIS PRODUCT TO RAIN OR MOISTURE.

Apparatus shall not be exposed to dripping or splashing and no objects filled with liquids, such as vases, shall be placed on the apparatus.

L'appareil ne doit pas être exposé à des égouttements d'eau ou des éclaboussures et de plus qu'aucun objet rempli de liquide tel que des vases ne doit être placé sur l'appareil.

REGULATORY INFORMATION:

This equipment has been tested and found to comply with the limits for a Class A digital device, pursuant to Part 15 of the FCC Rules. These limits are designed to provide reasonable protection against harmful interference when the equipment is operated in a commercial environment. This equipment generates, uses and can radiate radio frequency energy and, if not installed and used in accordance with the instruction manual, may cause harmful interference to radio communications. Operation of this equipment in a residential area is likely to cause harmful interference in which case the user should be required to correct the interference at his own expense.

CAUTION:

Do not attempt to modify this product in any way without written authorization from LG Electronics U.S.A., Inc. Unauthorized modification could void the user's authority to operate this product.

COMPLIANCE:

The responsible party for this product's compliance is: LG Electronics U.S.A., Inc.
2000 Millbrook Drive, Lincolnshire, IL 60069, USA • Phone: 1-847-941-8000

Marketed and Distributed in the United States by LG Electronics U.S.A., Inc.
2000 Millbrook Drive, Lincolnshire, IL 60069

IMPORTANT SAFETY INSTRUCTIONS

1. Read these instructions.
2. Keep these instructions.
3. Heed all warnings.
4. Follow all instructions.
5. Do not use this apparatus near water.
6. Clean only with dry cloth.
7. Do not block any ventilation openings. Install in accordance with the manufacturer's instructions.
8. Do not install near any heat sources, such as radiators, heat registers, stoves, or other apparatus (including amplifiers) that produce heat.
9. Do not defeat the safety purpose of the polarized or grounding-type plug. A polarized plug has two blades with one wider than the other. A grounding-type plug has two blades and a third grounding prong. The wide blade or the third prong are provided for your safety. If the provided plug does not fit into your outlet, consult an electrician for replacement of the obsolete outlet.
10. Protect the power cord from being walked on or pinched, particularly at plugs, convenience receptacles, and the point where it exits from the apparatus.
11. Only use attachments/accessories specified by the manufacturer.
12. Use only with the cart, stand, tripod, bracket, or table specified by the manufacturer or sold with the apparatus. When a cart is used, use caution when moving the cart/apparatus combination in order to avoid injury from tip-over.
13. Refer all servicing to qualified service personnel. Servicing is required when the apparatus has been damaged in any way, such as power-supply cord or plug is damaged, liquid has been spilled or objects have fallen into the apparatus, the apparatus has been exposed to rain or moisture, does not operate normally, or has been dropped.
14. **Power Sources**

This product should be operated only from the type of power source indicated on the marking label. If you are not sure of the type of power supply to your INSTALLATION, consult your product dealer or local power company.
15. **Overloading**

Do not overload wall power outlets and extension cords as this can result in a risk of fire or electric shock.
16. **Disconnect Device**

The AC mains plug is used as the disconnect device. The disconnect device must remain readily operable.
17. **Object and Liquid Entry**

Never push objects of any kind into this product through openings as they may touch dangerous voltage points or short-out parts that could result in a fire or electric shock. Never spill liquid of any kind on the product. Do not use liquid cleaners or aerosol cleaners.
18. **Outdoor Use**

 **Warning: To prevent fire or shock hazards, do not expose this product to rain or moisture.**
19. **Wet Location**

Do not use this product near water or moisture or in an area, such as a basement, that might become flooded. The apparatus shall not be exposed to dripping or splashing and no objects filled with liquids, such as vases, shall be placed on the apparatus.
20. **Test Equipment**

In some cases, LG has supplied or recommended the use of test equipment and devices for the setup and testing of the equipment. The operation and maintenance of test equipment is described in their associated instruction manuals. Please refer to these manuals for explicit instructions regarding the safe use and handling of the equipment.

(Continued on next page)

IMPORTANT SAFETY INSTRUCTIONS

(Continued from previous page)

21. Damage Requiring Service

Unplug this product from the wall power outlet and refer servicing to qualified service personnel under the following conditions:

- a. If the power-supply cord or plug is damaged.
- b. If liquid has been spilled, or objects have fallen into the product.
- c. If the product has been exposed to rain or water.
- d. If the product does not operate normally by following the operating instructions. Adjust only those controls that are covered by the operating instructions, as an improper adjustment of other controls may result in damage and will often require extensive work by a qualified technician to restore the product to its normal operation.
- e. If the product has been dropped or the cabinet has been damaged.
- f. If the product exhibits a distinct change in performance.



Caution: Refer all servicing to qualified service personnel.

22. Servicing



Caution: These servicing instructions are for use by qualified service personnel only. To reduce the risk of electrical shock, do not perform any servicing other than that described in the operating instructions unless you are qualified to do so.

23. Replacement Parts

When replacement parts are required, be sure the service technician uses replacement parts specified by the manufacturer or that have the same characteristics as the original parts. Unauthorized substitutions may result in fire, electric shock, or other hazards.

24. Safety Check

Upon completion of any service or repairs to this product, ask the service technician to perform safety checks to determine that the product is in proper operating condition.

OAT100R Rack Installation

(also see pages 12 and 13)

To install the OAT100R in a rack:

- Carefully slide the OAT100R into a standard 19-inch equipment rack.
- When mounting in the rack, make sure to use the appropriate hardware. **ALL FOUR MOUNTING SCREWS MUST BE USED.**
- This equipment is not designed to support other devices. Do **NOT** stack other equipment on the top of the OAT100R.
- Rear cabling must be dressed and supported so that the weight of the cabling is not a strain on the OAT100R connectors.
- **MOUNTING OF THE EQUIPMENT IN THE RACK SHOULD BE SUCH THAT A HAZARDOUS CONDITION IS NOT ACHIEVED DUE TO UNEVEN MECHANICAL LOADING.**

Rack-mount Considerations

A. Elevated Operating Ambient

If installed in a closed or multi-unit rack assembly, the operating ambient temperature of the rack environment may be greater than room ambient. Therefore, consideration should be given to installing the equipment in an environment compatible with the maximum ambient temperature (T_{ma}) specified by the manufacturer (see Specifications information in this document).

(Continued on next page)

IMPORTANT SAFETY INSTRUCTIONS

(Continued from previous page)

B. Reduced Air Flow

Installation of the equipment in a rack should be such that the amount of air flow required for safe operation of the equipment is not compromised. To ventilate the system normally and avoid overheating, leave at least 1 inch (2.5 cm) on each side (including top and bottom) of the OAT100R. Do NOT stack other equipment on the top of the OAT100R. Also, ensure that the unit's AC power adapter is never stacked or bundled with other AC power adapters. Each adapter should have adequate ventilation and should be isolated from other heat sources.

C. Circuit Overloading

Consideration should be given to the connection of the equipment to the supply circuit and the effect that overloading of the circuits might have on overcurrent protection and supply wiring.

D. Reliable Earthing

Maintain reliable earthing of rack-mounted equipment. Particular attention should be given to supply connections other than direct connections to the branch circuit (e.g., use of power strips).

E. Mains Outlet Earthing

The apparatus with Class I construction must be connected to a mains socket outlet with a protective earthing connection.

OAT100R Server Installation on a Flat Surface

To install the OAT100R on a level surface (table top, shelf, etc.):

- Install the equipment in an environment compatible with the maximum operating ambient temperature (T_{ma}) specified by the manufacturer (see Specifications information in this document).
- Place spacers or rubber feet (not provided) on the bottom of the OAT100R.
- Carefully place the OAT100R on the level surface.
- To ventilate the system normally and avoid overheating, leave at least 1 inch (2.5 cm) on each side (including top and bottom) of the OAT100R. Do NOT stack other equipment on the top of the OAT100R.

Table of Contents

Safety Warnings	2	Configuration Options via Command Line	39–67
Important Safety Instructions.	3–5	Log In to the OAT100R and Access the Main Menu	39
Table of Contents	6	View System Information	40
OAT100R Product Description	7	Monitor the System	40
Setup Information	8–9	View the System Program Map	41
Packet Identifiers (PIDs) Overview	10	Tuner Menu Commands	42
Rear and Front Panel Overviews	11	Setup Menu Commands	48
Rack Installation	12–13	Update Menu Commands	65
Typical Rack Installation	12	Reset the System.	67
Rack-mount Considerations.	13	Exit the Current Session	67
System Setup	14–21	Troubleshooting.	68–72
Typical Setup Flowchart for OAT100R with RF Output	14	OAT100R Setup	68
Typical Setup Flowchart for OAT100R with IP Output.	15	OAT100R Communication	69
Typical System Installation.	16	Receiver Reception	70
Network and Communication Setup	22	Specifications	73
Configuration Options via GUI	23–38	Document Revision History / Notes	74
Access the OAT100R Web GUI.	23	Open Source Software Notice.	75
OAT100R System Status.	24	Warranty	Back Cover
Tuner Information.	25		
Tuner Menu Options	26		
Input Channel Options	28		
OAT100R System Setup Options	30		
MUX Setup Options	35		
OAT100R Maintenance Options	36		

OAT100R Product Description

The LG CodePlus™ OAT100R Off Air Transcoder System provides a flexible solution for system providers who provide terrestrial delivered DTV content to commercial facilities (hotels, hospitals, etc.). The OAT100R incorporates eight RF tuners that receive up to eight off air DTV channels from the terrestrial broadcast service.

Features

- Transcodes broadcast DTV content for distribution on SMATV or IPTV network
- Two output options: either RF or IP
 - RF output: The OAT100R generates four contiguous 256-QAM or 64-QAM cable channels. With 256-QAM output, up to two broadcast channels are multiplexed on each QAM channel, with support for up to eight programs per tuner input. This capability provides output of up to 64 programs. With 64-QAM output, one broadcast channel is multiplexed on each QAM channel, with support for up to eight programs per tuner input. This capability provides output of up to 32 programs.
 - IP output: The OAT100R provides up to eight multicast streams with support for up to eight programs each if provided in the original broadcast.
- Provides one MPEG-2 video output with up to two AC3 audio outputs per program
- Supports any QAM compatible television
- Transcoded output supports Closed Captions and V-Chip (Parental Control) (if included in the signal source)
- Remote management capability over Ethernet via either graphical user interface (GUI) or command line interface
- Small, lightweight chassis
- 19-inch rack-mountable
- 1U height profile to minimize rack space usage

The OAT100R converts terrestrial DTV programming to a groomed, multiplexed transport stream that is compatible with any digital television that supports QAM tuning.

Note: LG CodePlus PIVD100R (Pro:Idiom® Video Distribution) and OAT100R units may be combined in the head end to deliver an entire channel lineup of digital programming.

Note: Design and specifications subject to change without prior notice.

Setup Information

This document provides installation and setup support only for the OAT100R. One or more VHF and/or UHF antennas must be installed before you proceed to set up the OAT100R. LG recommends that the system be professionally installed.

Check the following items before you begin the OAT100R installation and setup procedures.

VHF and/or UHF Antennas

- ___ Create a station plan for the OAT100R terrestrial input(s).
- ___ Install the appropriate antenna(s) in accordance with the desired channels. The VHF and/or UHF antenna(s) must be located where it/they will have unobstructed access to the terrestrial signals. Amplify the antenna distribution as necessary.
- ___ Point the antenna(s) so as to achieve the best signal quality (use appropriate equipment for measurement purposes).
- ___ Up to eight 75 ohm RG-6 or larger coaxial cables from the terrestrial antenna distribution system should be available for connection to the OAT100R.
- ___ Confirm that the installation environment meets the >17 dB specification for the OAT100R RF input signal-to-noise ratio.
- ___ Measure the signal level at each of the OAT100R RF inputs. For proper system performance, the signal level at each RF input must be between +3 dBm (+52 dBmV) and -83 dBm (-34 dBmV). A nominal value of -53 dBm (-4 dBmV) is recommended. Note that additional equipment (i.e., attenuators) may be required to adjust the signal level.

OAT100R

- ___ Unpack the OAT100R unit and all accessories.

OAT100R Accessories: • AC Power Cord and Adapter

- ___ Select the location for mounting the OAT100R. Ensure that adequate ventilation is available.
- ___ Obtain the necessary attachment hardware to mount the OAT100R chassis in its targeted location.
- ___ Plan and install the necessary cabling and network (Ethernet) and AC power access for the OAT100R. You will also need the following to connect a PC directly to the OAT100R for system setup purposes: FTDI TTL-USB cable (P/N TTL-232R-5V-AJ).

Channel Assignments for RF Output

- ___ Create a channel assignment plan for the installation site, or modify an existing plan to incorporate the RF output of the OAT100R. Ensure that up to four contiguous CATV broadcast channels are allocated for the OAT100R RF output. The OAT100R uses either a 256-QAM or 64-QAM modulation format, thereby occupying approximately 24 MHz of frequency spectrum.

The RF start channel is user-assigned during system setup, and the remaining channels are then automatically assigned per EIA-542 STD CATV frequency allocation standards. For example, if the RF start channel assignment is channel 2, the three remaining channels

Setup Information (Cont.)

will be 3, 4, and 5. However, if the RF start channel assignment is 6, the three remaining channels will be 95, 96, and 97. Refer to EIA-542 STD CATV frequency allocation tables for further information as required.

The highest available RF channel number for the OAT100R is 135. Thus, to allocate all four channels available for OAT100R RF output, the RF start channel must be set no higher than 132.

- ___ Find a location on the frequency spectrum that is free of existing noise.

Channel Assignments for IP Output

- ___ The OAT100R outputs IPv4 multicast streams. Ensure the institution's IP network and room receivers support IPv4 multicast and that the network is capable of selectively routing multicast traffic. Refer to vendor equipment documentation for further information.

- ___ Create a channel assignment plan for the installation site, or modify an existing plan to incorporate the IP output of the OAT100R. Ensure that up to eight unused and unreserved IPv4 multicast addresses, within the designated range 224.0.0.0 to 239.255.255.255, are allocated for the OAT100R IP output.

IP channels are user-assigned during system setup. You may opt to specify an IP start channel and enable the system to auto-increment the remaining channel assignments. For example, if the IP start channel assignment is 227.0.0.40, the remaining channels will be 227.0.0.41, 227.0.0.42, etc. Or, you may opt to manually specify the IP details for each IP channel.

- ___ Reserve at least one User Datagram Protocol (UDP) port for the multicast data streams. You can use the system default (1234) or another unassigned port number for each data stream, as required, for example, 50000, 50001, etc. The port(s) must avoid conflict with other protocols in use.

Note: Refer to the IANA IPv4 Multicast Address Space Registry and/or the IANA Service Name and Transport Protocol Port Number Registry for further IP address/port information as required.

Packet Identifiers (PIDs)

Note: If Pro:Idiom channels are NOT present in the site's entertainment system, PIDs do not need to be set in the OAT100R, and therefore, you will not need to design a PID map for the OAT100R output.

Note: See also "Packet Identifiers (PIDs) Overview" on the following page.

- ___ Survey the PIDs currently used in the system, and design a PID map for the OAT100R output (ensure that up to 64 PIDs are allocated). Ensure that Pro:Idiom message PIDs are never used by the video/audio PIDs for the OAT100R channels (or any other system elements).

The program start PID is user-assigned during system setup, and the 63 remaining PIDs are then automatically assigned within the 64-PID contiguous block.

- ___ PIDs must be specified in the OAT100R system as hexadecimal numbers.

Packet Identifiers (PIDs) Overview

Each RF channel has five or more associated PIDs assigned in a hierarchy (see diagram below), and the content of each RF channel is carried in a transport stream.

The transport stream is a packet-based protocol, where each packet has a PID that is used to uniquely identify packets for particular purposes (video, audio, etc.). This allows multiple video and audio streams to be multiplexed without receiver confusion. For example, if a stream contains three video programs, each video program has a unique PID. The PAT PID is always 0x0000 and all other PIDs can be in the range 0x0010 to 0x1ffe, inclusive.

The PAT and PMT are tables that indicate which PIDs are used for which purposes. The PAT contains a list of PMT PIDs. The PMT contains a list of the PIDs of elementary stream data, such as audio or video, etc. Typical transport streams contain one PID for the PAT, as well as three or more PIDs for each program (one for PMT, one for video, and one or more for audio). The PIDs used for each elementary stream must be unique to allow receivers to properly demultiplex.

Pro:Idiom adds a third PID type to each PMT. The Pro:Idiom message PID may fall anywhere in the range 0x0010 to 0x1ffe, inclusive and also must be unique. If Pro:Idiom channels are present in the target system, ensure that Pro:Idiom message PIDs are never used on any other streams in that system. To facilitate PID allocation, the OAT100R uses a block of 64 contiguous PIDs that can be moved by selecting the start PID.

Refer to ISO/IEC 13818-1:2000, Section 2.4.3, "Specification of the Transport Stream syntax and semantics," for further information.

Typical PID Hierarchy

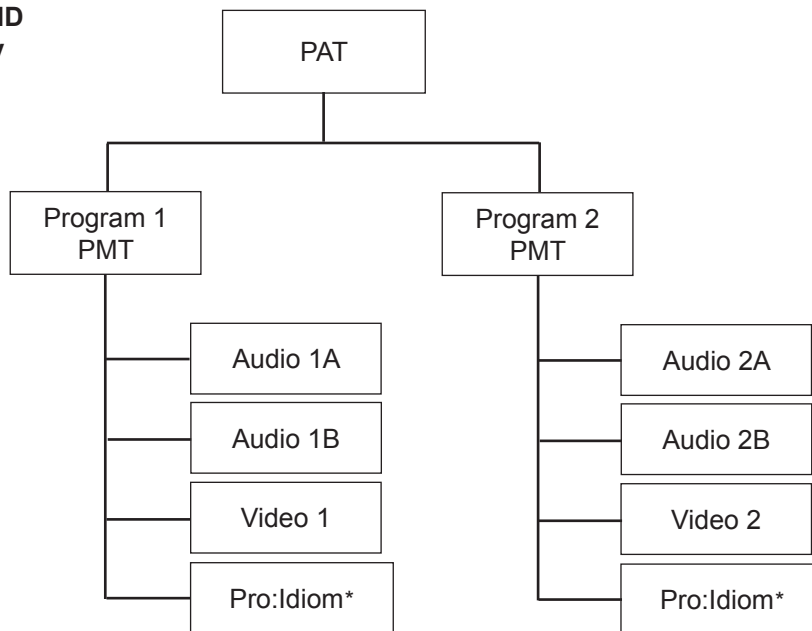

* For channels with Pro:Idiom encrypted content only.

Rear and Front Panel Overviews

OAT100R Rear View

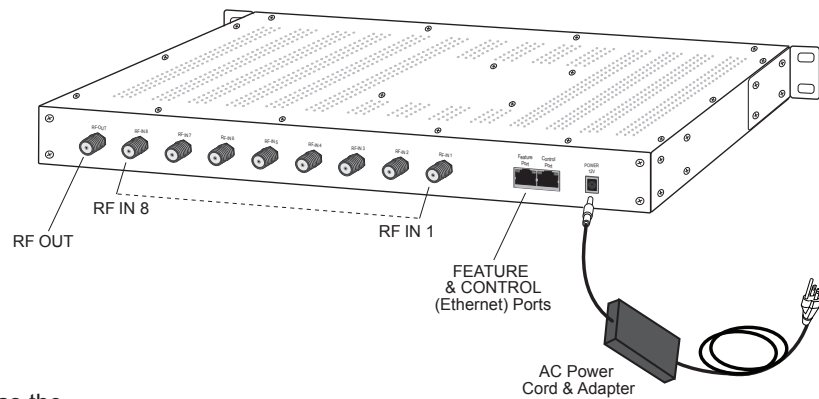

Disconnect Device

The AC mains plug is used as the disconnect device. The disconnect device must remain readily operable.

OAT100R Front View

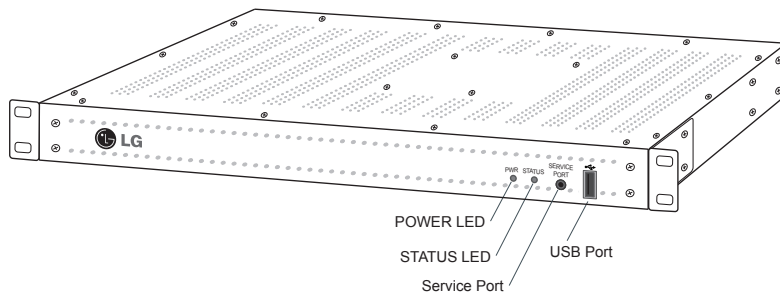

Ventilation Holes

Air flow must not be obstructed. To ventilate the system normally and avoid overheating, leave at least 1 inch (2.5 cm) on each side (including top and bottom) of the OAT100R. Do NOT stack other equipment on the top of the OAT100R.

Rack Installation

Typical Rack Installation

1. (Optional) As shipped, the OAT100R mounting brackets are attached flush with the front of the unit (see diagram a). If desired, the mounting brackets may be detached from the unit and reattached, for example, so that they are flush with the rear of the unit (see diagram b). If you wish to change the location/orientation of the mounting brackets, carefully remove each of the four (M4 x 10 mm) screws and attendant washers (one flat and one lock washer per screw) holding each bracket in place. Then, use the same screws and washers to reattach the mounting brackets in the desired location.
2. Carefully slide the chassis into a standard 19-inch equipment rack.
3. Use all four mounting screws to secure the chassis to the rack.

(a)

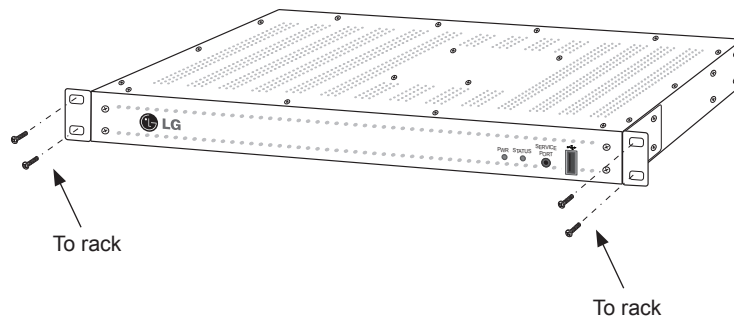

(b)

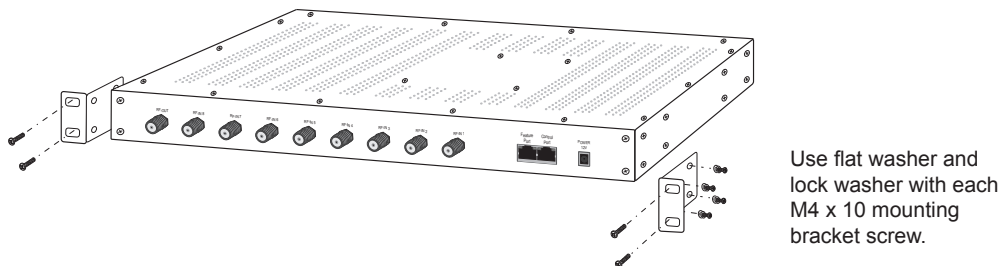

Rack Installation (Cont.)

Front View
of Rack Cabinet

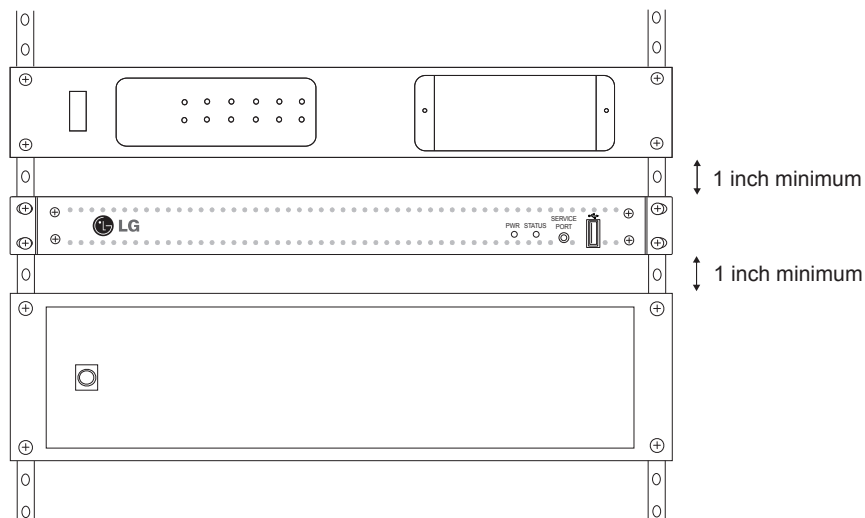

Rack-mount Considerations

A. Elevated Operating Ambient

If installed in a closed or multi-unit rack assembly, the operating ambient temperature of the rack environment may be greater than room ambient. Therefore, consideration should be given to installing the equipment in an environment compatible with the maximum ambient temperature (T_{ma}) specified by the manufacturer (see Specifications information in this document).

B. Reduced Air Flow

Installation of the equipment in a rack should be such that the amount of air flow required for safe operation of the equipment is not compromised. To ventilate the system normally and avoid overheating, leave at least 1 inch (2.5 cm) on each side (including top and bottom) of the OAT100R. Do NOT stack other equipment on the top of the OAT100R. Also, ensure that the unit's AC power adapter is never stacked or bundled with other AC power adapters. Each adapter should have adequate ventilation and should be isolated from other heat sources.

C. Circuit Overloading

Consideration should be given to the connection of the equipment to the supply circuit and the effect that overloading of the circuits might have on overcurrent protection and supply wiring.

D. Reliable Earthing

Maintain reliable earthing of rack-mounted equipment. Particular attention should be given to supply connections other than direct connections to the branch circuit (e.g., use of power strips).

E. Mains Outlet Earthing

The apparatus with Class I construction must be connected to a mains socket outlet with a protective earthing connection.

System Setup

Refer to the following diagrams, and complete the system installation as described on pages 16 to 21.

Caution: Do NOT make system connections until instructed to do so during the system installation procedure. In some instances, configuration steps must be performed before physical connections are made.

Typical Setup Flow Chart for OAT100R with RF Output

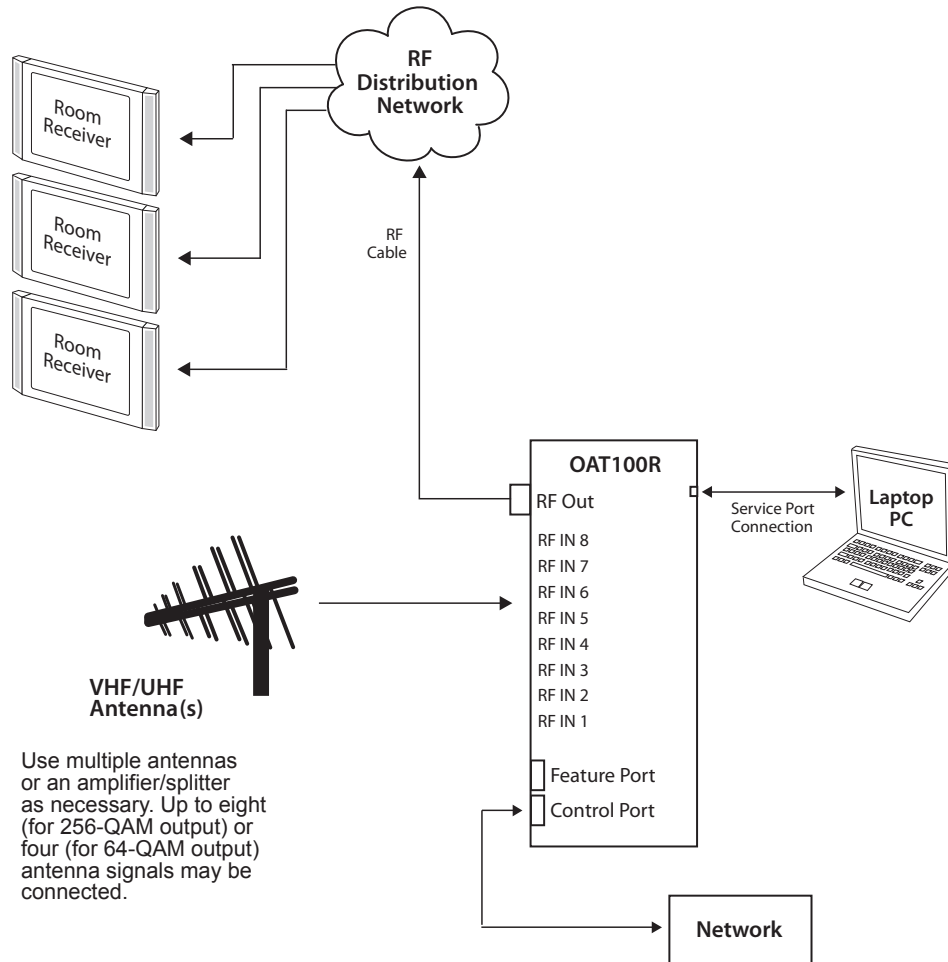

System Setup (Cont.)

Typical Setup Flow Chart for OAT100R with IP Output

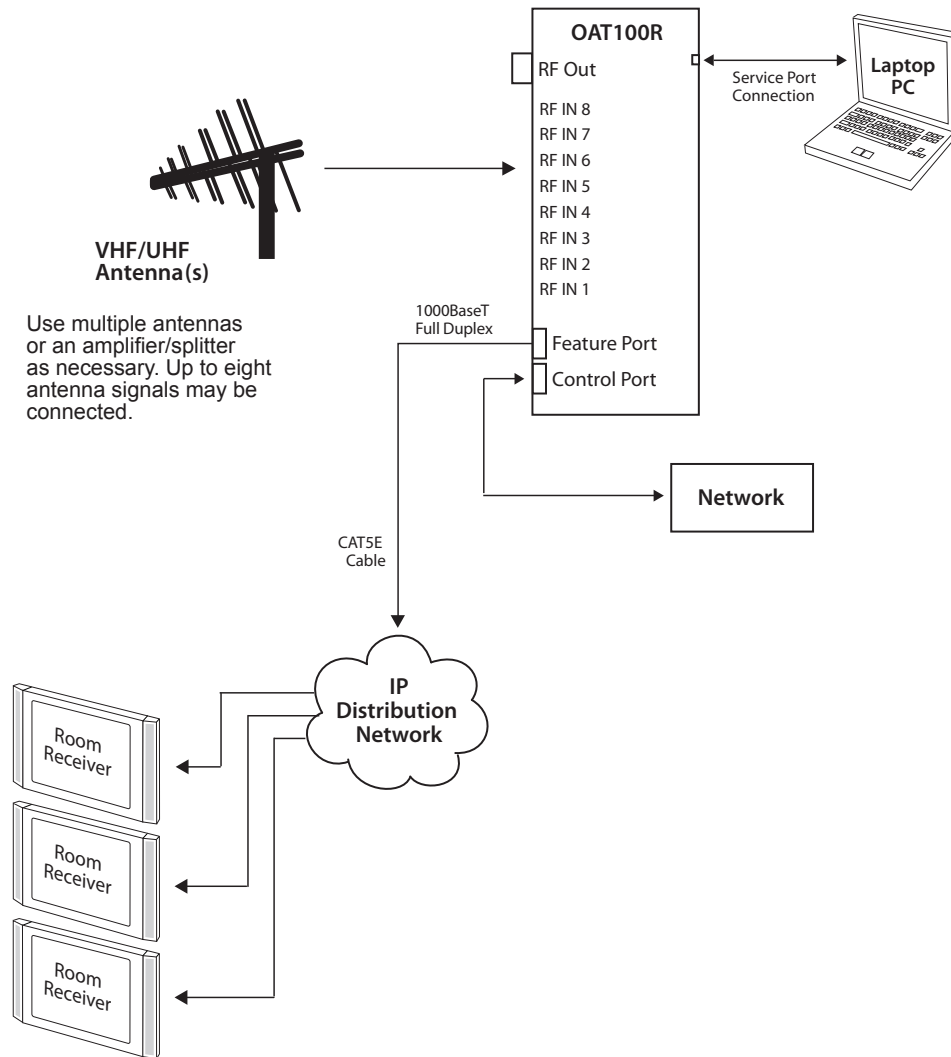

System Setup (Cont.)

Typical System Installation

(see also Typical Setup Flow Charts on the previous pages)

1. If not already done (see setup information on page 8):
 - Confirm that the installation environment meets the >17 dB specification for the OAT100R RF input signal-to-noise ratio.
 - Measure the signal level at each of the antenna RF inputs. For proper system performance, the signal level at each antenna input must be between +3 dBm (+52 dBmV) and -83 dBm (-34 dBmV). A nominal value of -53 dBm (-4 dBmV) is recommended.
2. Connect a 75 ohm RG-6 or larger coaxial cable from the terrestrial antenna distribution system to each RF IN port to be used on the OAT100R rear panel. Up to eight OAT100R RF tuners may be connected for RF 256-QAM output or IP output; up to four OAT100R RF tuners may be connected for RF 64-QAM output.
3. To enable remote management, connect one end of a CAT5 RJ-45 Ethernet cable to the Control Port on the OAT100R rear panel, and connect the other end of the cable to the institution's network.



Caution: The subnet 192.168.0.x is reserved for internal communication and cannot be used for the Control Port network subnet. This is the only restriction; for example, you can use 192.168.1.x, 10.x.x.x, etc. Contact your service representative for further information.

4. Connect the OAT100R power supply to the POWER connector on the OAT100R rear panel. Then, plug the AC power cord into a powered AC line receptacle. When power is applied, the PWR (Power) LED on the OAT100R front panel will initially flash red and then turn green.

The boot-up process for the OAT100R may take up to two minutes. When boot-up is complete, the STATUS LED on the OAT100R front panel will light continuously green.
5. Once the STATUS LED is lit continuously (no longer blinking), use the FTDI TTL-232R-5V-AJ cable to connect a PC to the Service Port on the OAT100R front panel.
6. Using HyperTerminal or an equivalent terminal emulation program on the PC, configure the serial port as follows: Bits per second/ baud = 115200; Data bits = 8; Parity = None; Stop bits = 1; Flow Control = None

Once the connection is established, you should see a login prompt. If the login prompt is not automatically displayed, press **Enter** to refresh the screen.
7. At the `login as:` prompt, type **admin** and press **Enter**. Then, at the `password:` prompt, type **Password4Partners** (case-sensitive) and press **Enter**.



Note: After the system setup is complete, it is highly recommended that you change the admin user password from its default value. See "Change the Login Password" on page 62 for further information.

(Continued on next page)

System Setup (Cont.)

(Continued from previous page)

8. At the `Command >` prompt, type **info** and press **Enter**. (You can press **Enter** at any OAT100R command prompt to view current menu, if desired.)

The initial System Information display identifies OAT100R default configuration settings, including the Control Port IP address, the PID configuration, and the output configuration, for example:

```
OAT100R
CodePlus Off Air Transcoder System
Copyright (c) 2010-2012 LG Electronics U.S.A, Inc.
Copyright (c) 2010-2012 Zenith Electronics LLC

SN:          201-12301011
Version      2.1
HW id:       12-19
Ctrl MAC:    00:0C:63:3A:FF:EC
Ctrl IP:     10.166.60.92
Program PIDs: 0x30 - 0x6f
Output:      RF
RF config:   Mode 2, 256-QAM-B, RF: 6 MHz, 5.36 MSps
RF channels: 2 3 4 5
Local time:  Tue Jan 8 14:42:02 CDT 2014
```

9. Check the Ctrl IP (Control Port IP address) field in the System Information display. By default, the OAT100R uses DHCP; thus, the DHCP server, if configured, assigns an IP address to the OAT100R once the OAT100R successfully connects to the network.
- If the Ctrl IP field shows an IP address, the OAT100R is up and running on the network. Continue with step 10.
 - If the network is configured for DHCP but the Ctrl IP field is blank, refer to “Network Setup” troubleshooting information on page 68.
 - If the network is not configured for DHCP, you will need to configure a static IP address for the OAT100R. Complete steps 10 to 13 (as required), and then set the OAT100R IP address using the commands indicated in step 14.
10. Check the Output field in the System Information display. If the default value (RF) does not identify the appropriate output type, set the output mode as follows:
- a) At the `Command >` prompt, type **setup** and press **Enter** to access the Setup Menu.
 - b) Use the Setup Menu “omode” command to set the appropriate output mode. See “Set the Output Mode” on page 49 for further information.
11. The next step depends on the output mode:
- If you are setting up the system for RF output, continue with step 12.
 - If you are setting up the system for IP output, go to step 13.

(Continued on next page)

System Setup (Cont.)

(Continued from previous page)

12. (RF output only) Complete OAT100R RF output configuration as follows:

- a) If the `Command >` prompt is on display, type **setup** and press **Enter** to access the Setup Menu.
- b) Use the Setup Menu “r” command to configure the RF mode and the RF channels. See “Configure the RF Output” on page 54 for further information.
- c) Connect RF OUT on the OAT100R rear panel to the RF distribution center combiner, and balance the RF signal so that the signal level at the TV(s) is between 0 to +7 dBmV.



Caution: For proper system performance, the OAT100R signal level at the TV input (ANTENNA IN) must be between 0 to +7 dBmV. Note that additional equipment (i.e., attenuators) may be required to adjust the signal level.

- d) Go to step 14.

13. (IP output only) Complete OAT100R IP output configuration as follows:

- a) If the `Command >` prompt is on display, type **setup** and press **Enter** to access the Setup Menu. Then, at the `Setup Command >` prompt, type **ipout** and press **Enter** to access the IP Output Configuration Menu.
- b) The IP Output Configuration Menu offers two options for configuring output IP channels:
 - To manually configure the output IP channels, use the “set” command. You will need to specify a multicast IP address and the multicast port number for each tuner.
 - To auto-configure output IP channels from a base multicast IP address and port number, use the “fill” command. Once you enter the base multicast IP address and the multicast port number, the system will auto-increment the remaining IP channels.

Refer to “Configure the IP Output” on pages 56 to 59 for further information on the IP Output Configuration Menu commands.

- c) (Optional) Use the IP Output Configuration Menu “ttl” command, as necessary, to set the multicast TTL, i.e., the number of hops allowed before the multicast data is dropped. If a router is being used on the system, the TTL value should be the number of router hops + 1. If a router is not being used, leave the TTL set to 1 (default).

Note: The option to set the TTL is available only with OAT100R version 2.0 or later software.

- d) Once you have completed the output IP configuration, make sure to use the IP Output Configuration Menu “apply” command to confirm and apply the configuration data to the system. Then, at the next `IP Output Command >` prompt, type **exit** and press **Enter** to return to the Setup Menu prompt.
- e) Connect a CAT5E or better cable between the Feature Port on the OAT100R rear panel and the institution’s IP distribution network.
- f) Continue with step 14.

(Continued on next page)

System Setup (Cont.)

(Continued from previous page)

14. (Optional) For remote management purposes, you can set a static IP address for the OAT100R Control Port as follows:
 - a) If the `Command >` prompt is on display, type **setup** and press **Enter** to access the Setup Menu.
 - b) At the `Setup Command >` prompt, type **setip** and press **Enter**. The system will display the current network configuration, followed by the Network Configuration Menu.
 - c) Use the Network Configuration Menu “ip” and “dns” commands to configure the Control Port. See “Configure the Control Port” on page 52 for further information.

Note: Review the New Network Configuration overview carefully before you confirm the Control Port configuration settings. Ensure each of the addresses was entered correctly.

Note: If you change the Control Port configuration, you will be prompted to reset the system. If you intend to modify additional configuration settings during the current session, you may wait until all changes are complete before you reset the system.
15. Once all physical connections to the OAT100R have been made and the Control Port IP address has been assigned or configured, you also have the option to complete the system setup remotely using either the web GUI or the command line interface.
 - To complete the system setup in the current session (via the Service Port), continue with step 16.
 - If you wish to complete the setup remotely, reset the system at this time: At either the `Command >` prompt or the `Setup Command >` prompt, type **reset** and press **Enter**. When you are ready, establish remote communication with the OAT100R, and then continue with step 16. Note that you may use the GUI to perform the configuration steps, if desired. Refer to “Network and Communication Setup” on page 22 for information on establishing remote communication with the OAT100R and/or “Configuration Options via GUI” on pages 23 to 38 for further information on the GUI.
16. (Required only if Pro:Idiom channels are present in the system) Check the Program PIDs field in the System Information display (if necessary, you can rerun the “info” command from either the `Command >` or `Setup Command >` prompt). If the default range (0x30 - 0x6f) is not appropriate for this system, set the PIDs as follows:
 - a) If the `Command >` prompt is on display, type **setup** and press **Enter** to access the Setup Menu.
 - b) Use the Setup Menu “pid” command to configure the program PIDs. See “Configure the Program PIDs” on page 50 for further information. Note that PIDs must be specified as hexadecimal numbers.
17. (Optional) If desired, you can identify the location in which the OAT100R is installed. The location description will be displayed as part of the System Information in the command line interface and as part of the System Status and Tuner Information screens in the GUI.

(Continued on next page)

System Setup (Cont.)

(Continued from previous page)

- a) If the `Command >` prompt is on display, type **setup** and press **Enter** to access the Setup Menu.
 - b) Use the Setup Menu “location” command to identify the site location. See “Identify the Site Location” on page 64 for further information.
18. (64-QAM output only) Streams 1, 2, 3, and 4 are configured by default when 64-QAM output is used, though any four of the OAT100R tuners may be mapped to these streams. In the default system configuration, Tuner 1 is mapped to Stream 1, Tuner 2 is mapped to Stream 2, etc. If Tuners 5, 6, 7, and/or 8 are among the four tuners that were connected to the terrestrial antenna distribution system, make sure the tuners are mapped to the appropriate streams, as follows:
- a) If the `Command >` prompt is on display, type **tuner** and press **Enter** to access the Tuner Menu.
 - b) At the `Enter Tuner number >` prompt, type the number of the first OAT100R RF IN port/tuner to configure. Then, press **Enter**.
The system will identify the current tuner and then display a Tuner Menu command prompt, for example:
`Current Tuner: Tuner-5`
 - c) Use the Tuner Menu “output” command to map the tuner to the appropriate stream (1, 2, 3, or 4). See “Configure Tuner/Output Assignments” on page 46 for further information.
 - d) Repeat step (c) for each of the additional three tuners, as required.
Note: Use the “tuner” command as described on page 43, to access the Tuner Menu for each of the tuners in turn.
 - e) When you are finished mapping the last tuner stream, at the `Tuner Command >` prompt, type **exit** and press **Enter** to return to the Main Menu `Command >` prompt.
19. (Optional) As part of the system setup, you will need to set tuner channel and program numbers. If you are not sure which RF channels and programs are available on each of the tuners, you may wish to run one or more RF scans before you set the channel and program numbers as described later in this procedure.
- a) If the `Command >` prompt is on display, type **setup** and press **Enter** to access the Setup Menu.
 - b) Use the Setup Menu “scan” command to initiate an RF scan. See “Scan for RF Channels” on page 55 for further information.

Note that an RF scan takes several minutes. When a scan is complete, the system will provide a listing of the available channels on the selected tuner(s) as well as the program(s) available for each of those channels.

(Continued on next page)

System Setup (Cont.)

(Continued from previous page)

Repeat this step for additional tuners as necessary; if multiple tuners are connected to one antenna, you do not need to run separate RF scans on each. Make note of the results, and then continue with step 20.

20. If the `Setup Command >` prompt is on display, type **exit** and press **Enter** to return to the `Main Menu Command >` prompt.

21. At the `Command >` prompt, type **tuner** and press **Enter** to access the Tuner Menu. The next series of steps will guide you through the process of setting the channel and program numbers and verifying the configuration for each tuner.

22. At the `Enter Tuner number >` prompt, type the number of the first OAT100R RF IN port/tuner to configure. Then, press **Enter**.

The system will identify the current tuner and then display a Tuner Menu command prompt, for example:

```
Current Tuner: Tuner-1  
Tuner-1 Command >
```

23. Use the Tuner Menu “channel” and “prog” commands, respectively, to set the channel and program(s) for the tuner. Refer to “Set the Tuner Channel” and “Program Mapping” on pages 44 and 45 for further information.

24. At the next `Tuner Command >` prompt, type **info** and press **Enter**, and then check the following fields in the Tuner Information display:

- SNR: To avoid interference, the signal-to-noise ratio should be greater than 18.
- FEC Errors: There should be zero (0) forward error correction (FEC) errors.
- Locked: The tuner should be locked to the antenna signal.

If any of these fields shows a value that is NOT in accordance with the specifications above, refer to “Receiver Reception” troubleshooting information on page 70.

25. Repeat steps 23 and 24 for each tuner being used.

Note: Use the “tuner” command, as described on page 43, to access the Tuner Menu for each of the tuners in turn.

26. If you changed the Control Port configuration (see step 14) and you have not yet reset the system, type **exit** and press **Enter** to return to the `Main Menu Command >` prompt. Then, reset the system as follows:

- a) At the `Command >` prompt, type **reset** and press **Enter**.
- b) At the prompt for confirmation, type **y** and press **Enter**.

The reset process, during which each of the tuners will also be reinitialized, may take up to two minutes, after which the system resumes normal operation.

27. Check one or more room receivers to make sure all content is properly mapped and available.

Network and Communication Setup

This section describes OAT100R communication options for configuration purposes.



Note: Before you proceed with any additional configuration, the system should be installed and operating as described in the system installation procedure on pages 16 to 21.

Also note that configuration updates periodically require that you reset the OAT100R. Make sure to reset the unit when directed to do so.

There are three options for communicating with the OAT100R.

- When the OAT100R is connected to an IP network, you can use a standard Internet browser to communicate with the OAT100R via a graphical user interface (GUI).
- When the OAT100R is connected to an IP network, you can also use an SSH client to communicate with the OAT100R via a command line interface.
- To establish a direct connection to the OAT100R, connect a PC to the serial port on the OAT100R using the FTDI TTL-USB cable (P/N TTL-232R-5V-AJ). Plug the USB end of the cable into an open USB port on your PC. If necessary, install the device driver. Plug the other end of the cable into the Service Port jack on the OAT100R rear panel.

Using HyperTerminal or an equivalent terminal emulation program on the PC, configure the serial port as follows:

- Bits per second/ baud = 115200
- Data bits = 8
- Parity = None
- Stop bits = 1
- Flow Control = None

OAT100R configuration options via web GUI are described on pages 23 to 38; OAT100R configuration options via command line are described on pages 39 to 67. For security and control purposes, some options available from the command line menus are not available from the GUI.

You will need to know the “admin” user password in order to log in to either the web GUI or the command line interface. The default admin user password is “Password4Partners” (case-sensitive). If necessary, for example, if the password has been changed from its default value, consult the system administrator to obtain the current admin user password.

Note: The default network setting for the OAT100R is DHCP, in which case the server assigns an IP address to the OAT100R. If necessary, consult the network administrator to obtain the IP address that has been assigned to the OAT100R.

Note: If you want to connect the PC directly to the OAT100R Control Port using an Ethernet CAT5E cable, in order to establish communication you must first connect the PC to the OAT100R Service Port and set the OAT100R’s IP address (see “Configure the Control Port” on page 52). The OAT100R’s IP address must be on the same subnet as the PC’s IP address.

Configuration Options via GUI

Access the OAT100R Web GUI

Note: The OAT100R must be connected to an IP network for GUI access. See “Network and Communication Setup” on page 22 for further information.

If necessary, consult the system administrator to obtain the current “admin” user password before proceeding. The default admin user password is “Password4Partners” (case-sensitive).

1. Launch a web browser, and type **http://ipaddress** in the browser’s address bar, where *ipaddress* is the network IP address of the OAT100R. Then, press **Enter**.
2. The system will display a login authentication pop-up window. In the User Name field, type **admin**; in the Password field, type the admin user password. Then, click **OK**.

The OAT100R web GUI opens with the System Status on display (see “OAT100R System Status” on the next page for further information). The options panel at the left of the screen enables you to view and configure system settings. The following sections provide detailed information on the configuration settings and commands.

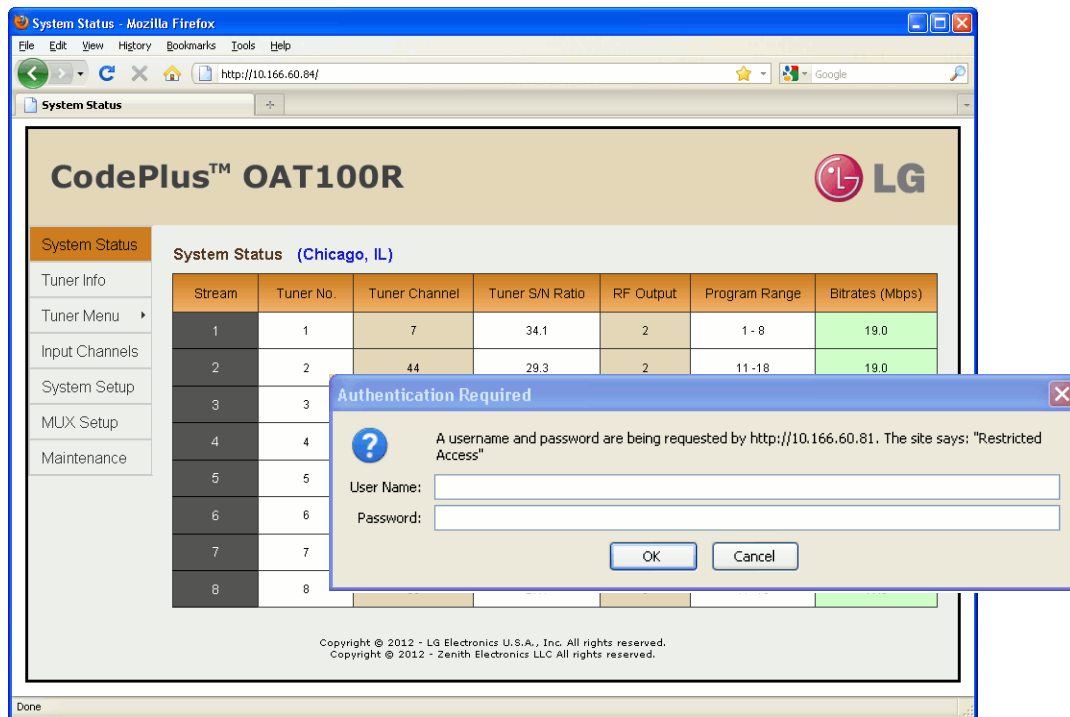

Note: It is possible, if desired, to change the login password via the command line interface Setup Menu “pwd” command as described on page 62.

When you have completed your activities in the OAT100R web GUI, it is recommended that you close your browser to prevent unauthorized access to the system.

Configuration Options via GUI (Cont.)

OAT100R System Status

Note: In both the System Status and Tuner Information screens, the site location, if specified in the System Setup screen or in the command line interface Setup Menu, is identified in blue text to the right of the screen title.

For each transport stream, the System Status screen identifies the tuner (OAT100R RF IN port) number, the tuner channel number, the tuner signal-to-noise (S/N) ratio, the program number range, and the streaming bitrates. Depending on the output mode, the display also identifies (for each stream) either the RF channel or the multicast IP address and port number.

From the System Status screen, you can click on a tuner channel number to access the Tuner Menu for the selected tuner. Also, you can click on an RF channel number or multicast IP address, depending on the output mode, to access the System Setup screen and menu options for the OAT100R. Refer to “Tuner Menu Options” on pages 26 to 28 for information on the Tuner Menu and “OAT100R System Setup Options” on pages 30 to 34 for information on the System Setup display and menu options.

To view the System Status data at any time while you are working in the web GUI, click on **System Status** in the options panel at the left of the screen.

Stream	Tuner No.	Tuner Channel	Tuner S/N Ratio	Multicast IP Output	Program Range	Bitrate (Mbps)
1	1	7	35.6	232.18.1.1 : 1234	1 - 8	19.2
2	2	19	28.6	224.0.0.1 : 1234	1 - 8	18.4
3	3	21	31.3	231.5.0.2 : 5878	1 - 8	16.4
4	4	27	31.5	238.5.0.3 : 53211	1 - 8	18.6
5	5	29	32.6	229.6.0.4 : 1234	1 - 8	17.0
6	6	30	17.8	227.6.0.5 : 63222	1 - 8	8.2
7	7	31	31.3	239.6.0.6 : 1234	1 - 8	15.0
8	8	36	29.3	233.6.0.8 : 1234	1 - 8	19.1

Copyright © 2012 - LG Electronics U.S.A., Inc. All rights reserved.
Copyright © 2012 - Zenith Electronics LLC All rights reserved.

Typical System Status Screen

The Tuner S/N Ratio and Bitrates columns refresh every 30 seconds with the latest data. The background colors in these columns provide the following information about the data values:

- Signal-to-noise ratio: Under standard operating conditions, the signal-to-noise ratio value should be shown with a white background. If a tuner’s signal-to-noise ratio is less than 18, the value will be shown with a **yellow** background.

Configuration Options via GUI (Cont.)

- Bitrates: If a bitrates value is shown with a **green** background, the data transmission is within a standard operating range; if the bitrates value is shown with a **yellow** background, the data transmission may be too slow (i.e., between 0.2 and 2 Mbps); and if the bitrates value is shown with a **red** background, there is little to no data transmission (under 0.2 Mbps). If a tuner is powered off, the Bitrates column will show "N/A."

Note: The System Status screen sample on the previous page shows a typical system with RF 256-QAM output. For a system with RF 64-QAM output, the System Status will show up to four streams. Streams 1, 2, 3, and 4 are configured by default when 64-QAM output is used, though any four of the OAT100R tuners may be mapped to these streams (see "MUX Setup Options" on page 35 for further information).

Tuner Information

Note: In both the System Status and Tuner Information screens, the site location, if specified in the System Setup screen or in the command line interface Setup Menu, is identified in blue text to the right of the screen title.

For each tuner, the Tuner Information screen identifies the tuner channel number, the powered state of the tuner, the lock status of the signal, the signal-to-noise (S/N) ratio, the number of FEC errors, and the input bitrates.

Under standard operating conditions a powered tuner should be locked to the antenna signal; the signal-to-noise ratio should be greater than 18; the number of FEC errors should equal "0" (zero); and the input bitrates should equal 19.4 Mbps. If one or more tuners does not appear to be operating normally, refer to "Receiver Reception" troubleshooting information on page 70.

CodePlus™ OAT100R		Tuner Info (Chicago, IL)					
Tuner No.	Channel	Power State	Signal Lock	S/N Ratio	FEC Error	Bitrates (Mbps)	
1	7	On	Locked	35.1	0	19.4	
2	27	On	Locked	30.7	0	19.4	
3	29	On	Locked	31.5	0	19.4	
4	45	On	Locked	31.8	0	19.4	
5	39	On	Locked	23.7	0	19.4	
6	43	On	Locked	31.1	0	19.4	
7	36	On	Locked	29.9	0	19.4	
8	47	On	Locked	29.9	0	19.4	

Typical Tuner Information Screen

Configuration Options via GUI (Cont.)

From the Tuner Information screen, you can click on a tuner channel number to access the Tuner Menu for the selected tuner. Refer to “Tuner Menu Options” on pages 26 to 28 for information on the Tuner Menu.

To view the tuner information data at any time while you are working in the web GUI, click on **Tuner Info** in the options panel at the left of the screen.

Note: If a tuner is powered off, the Power State column in the Tuner Information screen will indicate “Off,” and the Bitrates column will show “N/A.” The Bitrates column of the System Status screen will also show “N/A” to reflect the powered off status of the tuner.

8	50	Off	Not Locked	0.0	0	N/A
---	----	-----	------------	-----	---	-----

Tuner Menu Options

The Tuner Menu screen enables you to view and/or modify tuner configuration. To access the Tuner Menu for a selected tuner, either:

- Click on the desired tuner channel number in the System Status or Tuner Information screen, or
- Click on **Tuner Menu** in the options panel at the left of the screen, and then select the appropriate tuner number from the submenu (see example below).

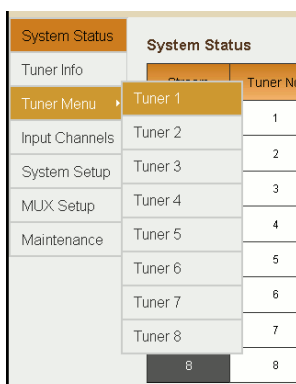

On the left side of the Tuner Menu screen, an Information section displays tuner status and configuration data, including the tuner channel number, the power and signal lock status of the tuner, the tuner signal-to-noise ratio, the FEC error count, and the output stream number.

Note: Output streams are mapped in the MUX Setup screen. See “MUX Setup Options” on page 35 for further information.

On the right side of the Tuner Menu screen, several menu options are available, as described in the following subsections.

Configuration Options via GUI (Cont.)



Typical Tuner Menu Screen

Set the Tuner Channel

In the Change Channel section of the Tuner Menu screen, you can specify the appropriate channel number for the tuner.

Note: It is also possible to set tuner channels in the Input Channels screen. See “Modify Tuner/Output Assignments” on page 35 for further information.

Note: If the system is set for RF 64-QAM output, up to four tuners can be used at a time.

1. Click on the down arrow at the right of the Channel Number field, and select either the desired channel number or N/C (no connection) from the drop-down list of options.
2. Click on the **Set** button at the right of the field.

If the channel is set successfully, the system will display **Success** at the bottom of the Tuner Information display.

(Continued on next page)

Configuration Options via GUI (Cont.)

(Continued from previous page)

When you click “Set,” the system will also search for and then identify the program(s), if any, found for the selected channel, for example:

3 program(s) found for this channel: [1](#) [2](#) [3](#) or No Program found for this channel:

Refer to the “Program Mapping” section below for information on assigning programs to transport streams.

Note: The system does not determine whether a particular channel is valid for your system; it only determines if a “Change Channel” operation is successful.

Program Mapping

After a tuner channel is set, input programs are initially assigned to transport streams (output programs) in numerical order. If more than eight programs were found, the first eight will be assigned. In the Program Mapping section of the Tuner Menu screen, you can edit the program assignments, as desired.

1. Edit the program number in each Input Program field, as required. Note that duplicate input program numbers are not allowed. Type **NC**, if necessary, to indicate “no connection.”
2. When you have completed the fields as required, click on the **Set** button at the bottom of the Input Program column to confirm your settings.

If you successfully set the program mapping parameters, the system will display **Success!** at the bottom of the Tuner Information display.

Power the Tuner On or Off

In the Tuner Power section of the Tuner Menu screen, you can power ON or power OFF the tuner.

- To power ON the tuner, click on the **On** button.
- To power OFF the tuner, click on the **Off** button.

In each case, if the action is completed successfully, the system will display **Success!** at the bottom of the Tuner Information display. However, note that the power ON process may take up to 90 seconds as tuner firmware is reloaded. If desired, you can track the tuner progress via the command line interface Tuner Menu “info” command (see “View Tuner Information” on page 43 for further information).

Note: If a Tuner is powered off, the Power State column in the Tuner Information screen will indicate this status.

Input Channel Options

The Input Channels screen enables you to scan for available off air RF channels for the selected tuner(s) and also enables you to assign tuner channels. To access the Input Channels screen, click on **Input Channels** in the options panel at the left of the screen (see example on following page).

Configuration Options via GUI (Cont.)

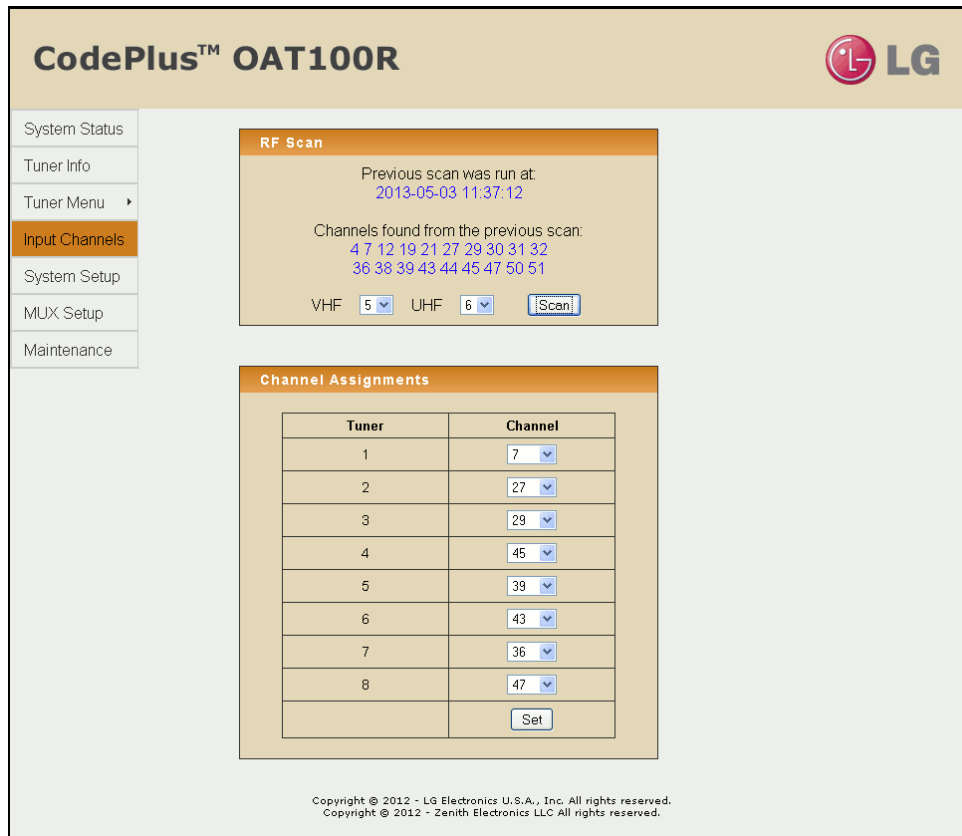

Typical Input Channels Screen

Scan for RF Channels

In the RF Scan section of the Input Channels screen, you can select up to two tuners at a time and initiate a scan for all available off air RF channels. If an RF scan was run previously, the screen will show the date and time of the previous scan, along with a listing of the channels found.

1. Click on the down arrow at the right of the VHF and/or UHF fields, and select the tuner(s) to scan for RF channels.
2. Click on the **Scan** button to initiate the scan.

The RF scan will take several minutes. When the scan is complete, the system provides a listing of the channels found for the selected tuner(s).

Note: If multiple tuners are connected to one antenna, you do not need to run separate RF scans on each.

Note: If the system is set for RF 64-QAM output, up to four tuners can be used at a time. Make sure the tuners to be scanned have been mapped to streams in the MUX Setup screen (see "MUX Setup Options" on page 35); otherwise, the RF scan(s) will not find any channels.

Configuration Options via GUI (Cont.)

Modify Tuner/Channel Assignments

1. Click on the down arrow at the right of each Channel field you wish to reassign, and select from the drop-down list of options the appropriate channel number or N/C (no connection) for the tuner listed in the Tuner column.
2. When you have completed the assignments, click on the **Set** button at the bottom of the Channel column.
3. The system will display a pop-up window prompting for confirmation of the changes. Either:
 - Click **OK** to confirm and apply the new assignments.
 - Click **Cancel** to return to the Input Channels screen without saving your changes.

If you successfully change the tuner/channel assignments, the system will display **Success!** at the bottom of the Input Channels screen.

OAT100R System Setup Options

The System Setup screen enables you to view and/or modify the system configuration. To access the System Setup screen, click on **System Setup** in the options panel at the left of the screen (see example on following page).

On the left side of the System Setup screen, the System Information section provides important information about the current configuration of the OAT100R, including the unit serial number, software version, hardware ID (firmware version), Control Port MAC and IP addresses, and output configuration. On the right side of the screen, several menu options are available, as described in the following subsections.

Configure the Program PIDs

If any Pro:Idiom channels are configured in the site's entertainment system, you must configure program PIDs for the OAT100R output in the Program PID section of the System Setup screen. See "Packet Identifiers (PIDs) Overview" on page 10 for further information, and/or check with your service representative, if necessary. Type the starting program PID number in hexadecimal format in the Start PID Number field, and then click on the **Set** button at the right of the field. The system will auto-increment the remaining 63 program PIDs from the starting PID.

If you successfully set the starting program PID, the system will display **Success!** at the bottom of the System Information display. The System Information display will also show the updated program PID range.

Identify the Site Location

In the Location Description section of the System Setup screen, you can identify the site in which the OAT100R is installed. Type the location description directly into the text field provided, and then click on the **Set** button at the right of the field. If you successfully set the location description, the system will display **Success!** at the bottom of the System Information display.

If specified in the System Setup screen (as described above) or in the command line interface Setup Menu, the site location is identified in blue text at the right of the System Status and Tuner Information screen titles.

Configuration Options via GUI (Cont.)

CodePlus™ OAT100R



System Status	System Information	Location Description
Tuner Info	Serial Number: 201-12301011	Chicago, IL <input type="text"/> <input type="button" value="Set"/>
Tuner Menu ▶	Version: 2.1	
Input Channels	Hardware ID: 11-21	Program PID
System Setup	Control Port MAC: 00:0C:63:3A:FF:D8	Start PID Number (hex): <input type="text" value="30"/> <input type="button" value="Set"/>
MUX Setup	Control Port IP: 10.166.60.87	
Maintenance	Program PID Range: 0x30 - 0x6f	Control Port IP Configuration
	Output: RF (256-QAM)	DHCP Mode: <input checked="" type="radio"/> Enable <input type="radio"/> Disable
	RF Channels: 2 3 4 5	Hostname: <input type="text" value="oat100r"/>
	Time Zone: America, Chicago	IP Address: <input type="text"/>
	Current Time: Tuesday, January 08, 2014 12:04:39	Subnet Mask: <input type="text"/>
		Default Gateway: <input type="text"/>
		Primary DNS IP Address: <input type="text"/>
		Secondary DNS IP Address: <input type="text"/>
		<input type="button" value="Set"/>
		Output Mode
		<input checked="" type="radio"/> RF <input type="radio"/> IP
		RF Output Configuration
		RF Mode: <input type="radio"/> 64-QAM <input checked="" type="radio"/> 256-QAM
		Start RF Channel: <input type="text" value="2"/> <input type="button" value="Set"/>
		Time Configuration
		Time Zone: <input type="text" value="America/Chicago"/> ▼
		NTP: <input checked="" type="radio"/> Enable <input type="radio"/> Disable
		NTP Server: <input type="text" value="64.90.182.55"/>
		Date And Time:
		Year <input type="text" value="2012"/> ▼ Month <input type="text" value="Jun"/> ▼ Day <input type="text" value="20"/> ▼
		Hour <input type="text" value="14"/> ▼ Minute <input type="text" value="49"/> ▼
		<input type="button" value="Set"/>
		System Reset
		<input type="button" value="Reset"/>

Copyright © 2012 - LG Electronics U.S.A., Inc. All rights reserved.
Copyright © 2012 - Zenith Electronics LLC All rights reserved.

Typical System Setup Screen

Configuration Options via GUI (Cont.)

Control Port Configuration

In the Control Port IP Configuration section of the System Setup screen, you can modify the Control Port configuration as required.

1. Select the appropriate DHCP Mode—Enable (default) or Disable—by clicking the radio button at the left of the desired option.
Note: If DHCP is enabled, the server assigns an IP address to the OAT100R, and only the Hostname field will be editable. All other fields will be inaccessible/grayed out.
2. If desired, modify the name of the host in the Hostname field.
3. If DHCP is disabled, specify the host IP address, the subnet mask, the default gateway IP address, the primary DNS IP address, and the secondary DNS IP address in the fields provided. Type each in the format xxx.xxx.xxx.xxx.
4. When you have completed the fields as required, click on the **Set** button below the Secondary DNS IP Address field.

If you successfully changed the IP configuration of the Control Port, the system will display **Success! Reset the system!** at the bottom of the System Information display. The System Information display will also show the new Control Port IP address, if applicable.

5. Click on the **Reset** button in the System Reset section of the System Setup screen if you are ready to reset the system immediately (see “Reset the System” on page 34 for further information).
Note: If you intend to modify additional configuration settings during the current session, you may wait until all changes are complete before you reset the system.

Output Mode Configuration

In the Output Mode section of the System Setup screen, you can modify the OAT100R output configuration (see RF and IP output configuration examples on following page).

Note: If you reconfigure the system output from IP output to RF (256-QAM or 64-QAM) output or from 256-QAM output to 64-QAM output, all MUX and tuner settings will be reset to their default values.

Complete output configuration as follows:

1. Select the Output Mode—RF or IP—by clicking the radio button at the left of the appropriate option.
Note: Depending on the current configuration of the system, when you access the System Setup screen, either the RF Output Configuration or IP Output Configuration fields initially will be on display below the Output Mode options. If you select a new mode, the system will display the applicable fields per your selection.

(Continued on next page)

Configuration Options via GUI (Cont.)

(Continued from previous page)

2. Refer to the appropriate subsection below, depending on the output mode selected, to complete the output configuration fields.

RF Output Configuration

- a) Select the RF Mode—64-QAM or 256-QAM (default)—by clicking the radio button at the left of the appropriate option.
- b) In the Start RF Channel field, type the RF start channel number. The remaining three channels will be automatically assigned per EIA-542 STD CATV frequency allocation standards.

IP Output Configuration

- a) For each IP channel stream, type the appropriate multicast IP address and port number in the IP Address and IP Port fields, respectively.

Note: If you would like the OAT100R to auto-increment IP channels from a base multicast IP address, you will need to complete output IP channel configuration from the command line interface. See “Configure the IP Output” on pages 56 to 59 for further information.

- b) (Optional) In the TTL field, specify the number of hops allowed before the multicast data is dropped. If a router is being used on the system, the TTL value should be the number of router hops + 1. If a router is not being used, leave the TTL set to 1 (default).

Note: The option to set the TTL is available only with OAT100R version 2.0 or later software.

3. When you have completed the fields as required, click on the **Set** button below the Start RF Channel field or below the last IP Port field, as applicable.

If you successfully changed output configuration parameters, the system will display **Success** at the bottom of the System Information display. The System Information display will also show the updated output configuration.

Output Mode

RF IP

RF Output Configuration

RF Mode: 64-QAM 256-QAM

Start RF Channel:

Typical RF Output Configuration Fields

Output Mode

RF IP

IP Multicast Output Configuration

Stream	IP Address	IP Port
1	<input type="text" value="227.0.0.0"/>	<input type="text" value="1234"/>
2	<input type="text" value="227.0.0.1"/>	<input type="text" value="1234"/>
3	<input type="text" value="227.0.0.2"/>	<input type="text" value="1234"/>
4	<input type="text" value="227.0.0.3"/>	<input type="text" value="1234"/>
5	<input type="text" value="227.0.0.4"/>	<input type="text" value="1234"/>
6	<input type="text" value="227.0.0.5"/>	<input type="text" value="1234"/>
7	<input type="text" value="227.0.0.6"/>	<input type="text" value="1234"/>
8	<input type="text" value="227.0.0.7"/>	<input type="text" value="1234"/>

TTL:

Typical IP Output Configuration Fields

Configuration Options via GUI (Cont.)

Date and Time Configuration

By default, the OAT100R is synchronized with an NTP server and configured for the US Central time zone. If the OAT100R is connected to the Internet, the NTP client will periodically update the time setting on the OAT100R. If the OAT100R is not connected to the Internet, you also have the option to disable NTP synchronization and specify date and time data manually.

1. Click on the down arrow at the right of the Time Zone field in the Time Configuration section of the System Setup screen, and select the appropriate time zone from the drop-down list of options.
2. Select the appropriate NTP setting—Enable or Disable—by clicking the radio button at the left of the appropriate option.

Note: Per your selection, certain of the Time Configuration fields will become inaccessible/grayed out. If NTP is enabled, Date and Time fields will be grayed out; if NTP is disabled, the NTP Server field will be grayed out.

3. The next step depends on whether you enabled or disabled NTP:
 - If you enabled NTP, type the IP address of the NTP server in the NTP Server field.
 - If you disabled NTP, complete the Date and Time fields to manually specify the date and time for the OAT100R. Click on the down arrow at the right of each field (Year, Month, Day, Hour, Minute) to select the appropriate value from the drop-down list of options.
4. When you have completed the fields as required, click on the **Set** button at the bottom of the Time Configuration section.

If you successfully changed the OAT100R time configuration, the system will display **Success! Reset the system!** at the bottom of the System Information display. The System Information display will also show the updated information in the Time Zone and Current Time fields, as applicable.

5. Click on the **Reset** button in the System Reset section of the System Setup screen if you are ready to reset the system immediately (see “Reset the System” below for further information).

Note: If you intend to modify additional configuration settings during the current session, you may wait until all changes are complete before you reset the system.

Reset the System

1. Click on the **Reset** button in the System Reset section of the System Setup screen.
2. The system will display a pop-up window prompting for confirmation. Either:
 - Click **OK** to initiate a reset of the OAT100R. The reset process, during which each of the tuners will also be reinitialized, may take up to two minutes, after which the system resumes normal operation.
 - Click **Cancel** to return to the System Setup screen without resetting the OAT100R.

Configuration Options via GUI (Cont.)

MUX Setup Options

The MUX Setup screen enables you to reset or reconfigure tuner/output assignments. To access the MUX Setup screen, click on **MUX Setup** in the options panel at the left of the screen.

The screenshot shows the MUX Setup screen for the CodePlus™ OAT100R. The screen has a left-hand navigation menu with options: System Status, Tuner Info, Tuner Menu, Input Channels, System Setup, MUX Setup (highlighted), and Maintenance. The main area is titled 'MUX Setup' and contains a table with two columns: 'Stream' and 'Tuner'. The table has 8 rows, each representing a stream and its assigned tuner. The 'Reset' button is located at the bottom left of the table, and the 'Set' button is at the bottom right. Below the table, there is a copyright notice: 'Copyright © 2012 - LG Electronics U.S.A., Inc. All rights reserved. Copyright © 2012 - Zenith Electronics LLC All rights reserved.'

Stream	Tuner
1	1
2	2
3	3
4	4
5	5
6	6
7	7
8	8

Typical MUX Setup Screen

Note: If the system is set for RF 64-QAM output, the MUX Setup screen will show only four streams. Streams 1, 2, 3, and 4 are configured by default when 64-QAM output is used, though any four of the OAT100R tuners may be mapped to these streams.

Reset Tuner/Output Assignments

To reset the previous, i.e., last stored, tuner/output assignments, click on the **Reset** button at the bottom of the Stream column. The tuner/output assignments will be reset immediately.

Modify Tuner/Output Assignments

This option enables you to reconfigure tuner/output assignments. Note that each tuner can only be assigned to one output stream. For example: If Tuner 1 is currently streaming on Stream 1, you cannot map Tuner 1 to any additional streams. To remap Tuner 1 to a new stream, you must assign a different tuner to Stream 1.

1. Click on the down arrow at the right of each Tuner field you wish to reassign, and select from the drop-down list of options the appropriate tuner number or N/C (no connection) for the stream listed in the Stream column.

(Continued on next page)

Configuration Options via GUI (Cont.)

(Continued from previous page)

2. When you have completed the assignments, click on the **Set** button at the bottom of the Tuner column.

Note: The system will display an error message and will not allow you to continue if you attempt to map one tuner to multiple streams.

3. If no errors (i.e., duplicate tuners) are detected, the system will display a pop-up window prompting for confirmation of the changes. Either:
 - Click **OK** to confirm and apply the new assignments.
 - Click **Cancel** to return to the MUX Setup screen without saving your changes.

If you successfully change the tuner/output assignments, the system will display **Success!** below the MUX Setup screen. This operation typically takes up to 20 seconds

OAT100R Maintenance Options

The Maintenance screen enables you to update firmware and reset the system. To access the Maintenance screen, click on **Maintenance** in the options panel at the left of the screen.

CodePlus™ OAT100R

System Status
Tuner Info
Tuner Menu
Input Channels
System Setup
MUX Setup
Maintenance

System Reset
Reset

Firmware Update
Filename: Browse...
Upload
Status

Result:

Copyright © 2011-2012 - LG Electronics U.S.A., Inc. All rights reserved.
Copyright © 2011-2012 - Zenith Electronics LLC All rights reserved.

Typical
Maintenance
Screen

Configuration Options via GUI (Cont.)

Update the OAT100R Firmware

The appropriate update file must be provided by LG. The system will not download an improper file.

1. In the Firmware Update section of the Maintenance screen, either click on the **Browse** button at the right of or simply click in the Filename field, and navigate to/select the appropriate file from the File Upload pop-up window.
2. Once you have selected the appropriate file, click on the **Upload** button below the Filename field to initiate the firmware update.
3. The system will display a pop-up window prompting for confirmation to update the system. Either:
 - Click **OK** to continue.
 - Click **Cancel** to return to the Maintenance screen without updating the OAT100R firmware.

If you opt to proceed, the system will initiate the firmware update, and progress and results messages will be displayed in the Result section at the bottom of the screen, for example:

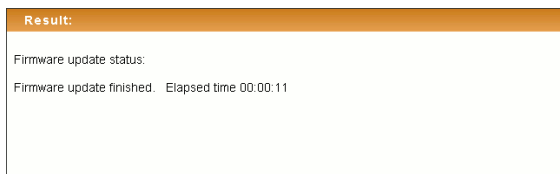

4. When the firmware update is finished, click on the **Reset** button in the System Reset section of the Maintenance screen to reset the system (see “Reset the System” on the following page for further information).

Check Firmware Update Status

In the Firmware Update section of the Maintenance screen, click on the **Status** button to check the current firmware update status.

The system will display firmware update status (for example, “Firmware Update finished” or “Firmware Update is in progress”) in the Result section at the bottom of the screen. If a firmware update has never been performed on this system, the Result display will show:

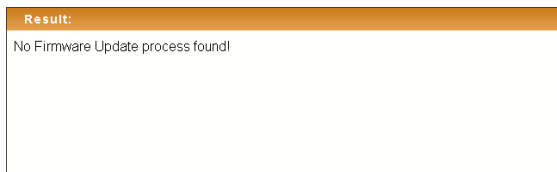

Configuration Options via GUI (Cont.)

Reset the System

1. Click on the **Reset** button in the System Reset section of the Maintenance screen.
2. The system will display a pop-up window prompting for confirmation. Either:
 - Click **OK** to initiate a reset of the OAT100R. The reset process, during which each of the tuners will also be reinitialized, may take up to two minutes, after which the system resumes normal operation.
 - Click **Cancel** to return to the Maintenance screen without resetting the OAT100R.

Configuration Options via Command Line

Log In to the OAT100R and Access the Main Menu

Note: The OAT100R must be connected to an IP network for SSH client access. For direct access to the OAT100R Service Port, use the FTDI TTL-USB cable (P/N TTL-232R-5V-AJ). See also “Network and Communication Setup” on page 22 for further information.

If necessary, consult the system administrator to obtain the current “admin” user password before proceeding. The default admin user password is “Password4Partners” (case-sensitive).

1. Establish communication with the OAT100R using an SSH client or via a direct connection to the OAT100R Service Port.

Once communication is established, you should see a login prompt. (If the login prompt is not automatically displayed, press **Enter** to refresh the screen.)

2. At the `login as:` prompt, type **admin** and press **Enter**.
3. At the `password:` prompt, type the admin user password and press **Enter**.
4. At the `Command >` prompt, either:
 - Press **Enter** to display the OAT100R Main Menu (see example below).
 - Type the desired command and press **Enter**.

The following sections describe each of the configuration commands.

Note: You can always press **Enter** at the `Command >` prompt to display the OAT100R Main Menu.

Example: OAT100R Main Menu

```
-----  
Main Menu  
-----  
  info           System information  
  monitor        System monitor  
  map            System program map  
  tuner          Tuner Menu  
  setup          Setup Menu  
  update         Update Menu  
  reset          System reset  
  exit           End session  
Command >
```

Configuration Options via Command Line (Cont.)

View System Information

1. Log in to the OAT100R as described on the previous page.
2. At the `Command >` prompt, type **info** and press **Enter**.

The System Information display identifies important information about the OAT100R, including the unit serial number, software version, hardware ID (firmware version), Control Port MAC and IP addresses, and output configuration, for example:

```
OAT100R
CodePlus Off Air Transcoder System
Copyright (c) 2010-2012 LG Electronics U.S.A, Inc.
Copyright (c) 2010-2012 Zenith Electronics LLC

Location:      Chicago, IL
SN:           201-12301011
Version       2.1
HW id:        12-19
Ctrl MAC:     00:0C:63:3A:FF:EC
Ctrl IP:      10.166.60.92
Program PIDs: 0x30 - 0x6f
Output:       RF
RF config:    Mode 2, 256-QAM-B, RF: 6 MHz, 5.36 MSps
RF channels:  2 3 4 5
Local time:   Tue Jan 8 14:42:02 CDT 2014
```

Note: If the system is configured for IP output, the Output field will show “IP” and RF fields will not be present. Also, the Location field is only present if the site location has been specified either in the GUI System Setup screen or in the command line interface Setup Menu.

It is recommended that you record this information for future reference. If you find it necessary to call customer service or engineering support, please have this information available.

Monitor the System

This option enables you to view static or dynamic system streaming data.

1. Log in to the OAT100R as described on the previous page.
2. At the `Command >` prompt, either:
 - Type **monitor** and press **Enter** to display the current system data (see example on following page).
 - To monitor streaming data in real time, type **monitor** and the number of seconds before the data refreshes. Then, press **Enter**. For example, to refresh the data every second, type **monitor 1** and press **Enter**.

When you are finished monitoring streaming data, press **Enter** to stop the system monitor and return to the `Command >` prompt.

Configuration Options via Command Line (Cont.)

Example: System Monitor Display

SYSTEM MONITOR

Date: 2014-01-09 16:44:27

Output: RF 256-QAM-B

Bitrates (Mbps):

Tun	RF In	SNR	Errs	Lck	Out	Str	RF Out	
1	50	25	0	Yes	15.7	1	3-1	:)
2	12	33	0	Yes	13.4	2	3-11	:)
3	19	29	0	Yes	18.4	3	4-1	:)
4	21	32	0	Yes	16.3	4	4-11	:)
5	27	26	0	Yes	18.6	5	5-1	:)
6	29	31	0	Yes	17.0	6	5-11	:)
7	31	33	0	Yes	15.1	7	6-1	:)
8	47	29	0	Yes	18.2	8	6-11	:)

Use a parameter for auto-refresh, e.g. type: "monitor 1"

View the System Program Map

1. Log in to the OAT100R as described on page 39.
2. At the Command > prompt, type **map** and press **Enter**.

The System Program Map display shows program assignments for each tuner, for example:

SYSTEM PROGRAM MAP

Date: 2014-01-09 12:28:41

SN: 201-12301011

Version: 2.1

HWID: 11-20

Output: RF 64-QAM-B

Tun	RF In-Prog	Str	RF Out
8	38-1	1	2-1
7	36-1	2	3-1
7	36-2	2	3-2
7	36-4	2	3-3
6	31-3	3	4-1
5	29-5	4	5-1
5	29-6	4	5-2

Configuration Options via Command Line (Cont.)

Tuner Menu Commands

The following subsections describe how to access and use the Tuner Menu commands.

Access the Tuner Menu

1. Log in to the OAT100R as described on page 39.
2. At the `Command >` prompt, type **tuner** and press **Enter**.
3. At the `Enter Tuner number [0] >` prompt, type the number of the OAT100R X-Port connected to the tuner for which you wish to view/modify configuration. Then, press **Enter**.

The system identifies the current tuner and then displays a Tuner command prompt, for example:

```
Current Tuner: Tuner-1
Tuner-1 Command >
```

4. At the `Tuner Command >` prompt, either:
 - Press **Enter** to display the Tuner Menu (see example below).
 - Type the desired command and press **Enter**.

Note: You can always press **Enter** at the `Tuner Command >` prompt to display the Tuner Menu.

Example: Tuner Menu

```
-----
Tuner Menu
-----
tuner      Change Tuner
info       Tuner info
monitor    System monitor
map        System program map
channel    Set channel
prog       Select programs
output     Output stream
on         Turn Tuner On
off        Turn Tuner Off
reset      Reset Tuner
exit       Return to the main menu

Tuner-1 Command >
```

Configuration Options via Command Line (Cont.)

Change Tuner

This command enables you to switch to the Tuner Menu for another tuner.

1. At the `Tuner Command >` prompt, type **tuner** and press **Enter**.
2. At the `Enter Tuner number [#]>` prompt, type the number of the OAT100R X-Port connected to the tuner for which you wish to view/modify configuration. Then, press **Enter**.

The system will identify the (newly) current tuner and then display a command prompt, for example:

```
Current Tuner: Tuner-3
Tuner-3 Command >
```

View Tuner Information

At the `Tuner Command >` prompt, type **info** and press **Enter** to display tuner status and configuration data, for example:

```
Tuner-1 Info
=====
Power:          On
Status:         Streaming
Channel:        7
SNR:           32.9
FEC errors:     0
Signal lock:    Yes
Bitrate:        19.4
Output:         7
```

```
Program selection:
Program 1: 1
Program 2: 2
Program 3: 3
Program 4: NC
Program 5: NC
Program 6: NC
Program 7: NC
Program 8: NC
```

Under standard operating conditions a powered tuner should be streaming (see also note on following page). In addition, the tuner should be locked to the antenna signal; the signal-to-noise ratio should be greater than 18; the number of FEC errors should equal "0" (zero); and the input bitrates should equal 19.4 Mbps. If a tuner does not appear to be operating normally, refer to "Receiver Reception" troubleshooting information on page 70.

Configuration Options via Command Line (Cont.)

Note: When a tuner is powered ON from a power OFF state, the Status field of the Tuner Information display reflects the progress of the power ON process, which may take up to 90 seconds as tuner firmware is reloaded. During the power ON process, the Status field shows “Initializing,” and once the process is complete, the Status field shows “Streaming.” A viewable stream appears 10 to 15 seconds after the tuner status changes to “Streaming.”

Monitor the System

This option enables you to view static or dynamic system streaming data and is also available from the OAT100R Main Menu and the Setup Menu.

At the `Tuner Command >` prompt, either:

- Type **monitor** and press **Enter** to display the current system data (see sample display under the “Monitor the System” section on page 40).
- To monitor streaming data in real time, type **monitor** and the number of seconds before the data refreshes. Then, press **Enter**. For example, to refresh the data every second, type **monitor 1** and press **Enter**.

When you are finished monitoring streaming data, press **Enter** to stop the system monitor and return to the `Tuner Command >` prompt.

View the System Program Map

This option enables you to display program assignments for each tuner and is also available from the OAT100R Main Menu and the Setup Menu.

At the `Tuner Command >` prompt, type **map** and press **Enter** to display the current system program assignments (see sample display under the “View the System Program Map” section on page 41).

Set the Tuner Channel

The terrestrial channel range is 2 to 69.

1. At the `Tuner Command >` prompt, type **channel** and press **Enter**.
2. At the `Enter channel [#]>` prompt, either:
 - Press **Enter** to accept the default value in square brackets, or
 - Type in a new channel number and then press **Enter**.

Note: If you enter channel “1” or a channel number that is higher than “69,” the system will display an “invalid channel” message and then return to the `Tuner Command >` prompt.

Note: To specify “no connection,” type **0** at the channel prompt and press **Enter**.

(Continued on next page)

Configuration Options via Command Line (Cont.)

(Continued from previous page)

If the channel is set successfully, the system will display confirmation and then will search for and identify the programs found for the specified channel, for example:

```
Channel: 7
Program selection (default):
  Program 1:  1
  Program 2:  2
  Program 3:  3
  Program 4:  NC
  Program 5:  NC
  Program 6:  NC
  Program 7:  NC
  Program 8:  NC
```

After a tuner channel is set, programs are initially assigned to transport streams in numerical order. If more than eight programs were found, the first eight will be assigned. You can edit the program assignments as desired using the “prog” command described below.

Program Mapping

1. At the `Tuner Command >` prompt, type **prog** and press **Enter**.

The system displays the current program settings and then displays the first of a series of prompts for each input program, for example:

```
Current program selection:
  Program 1:  1
  Program 2:  2
  Program 3:  3
  Program 4:  NC
  Program 5:  NC
  Program 6:  NC
  Program 7:  NC
  Program 8:  NC
```

```
Channel 7 programs: 1 2 3
```

```
Select input program 1 (use 0 for NC) [1]:
```

Note: Below the initial Current Program Selection list, the display identifies the programs that are available for the selected tuner/channel. More than eight programs may be available; however, only eight may be selected.

(Continued on next page)

Configuration Options via Command Line (Cont.)

(Continued from previous page)

2. At the `Select input program` prompt, either:
 - Press **Enter** to accept the default value in square brackets, or
 - Type **0** and press **Enter** to specify “no connection.”
 - Type in a new program number and press **Enter**.

After you enter input program 1, the system will prompt for input program 2, then input program 3, then input program 4, etc.

3. Repeat step 2 to select each of the eight input programs.

Once you specify the last input program, the system will display an overview of the new program configuration and prompt for confirmation, for example:

New program selection:

```
Program 1:  2
Program 2:  1
Program 3:  3
Program 4:  NC
Program 5:  NC
Program 6:  NC
Program 7:  NC
Program 8:  NC
```

Do you want to save the new configuration? [y/n]:

4. Either:
 - Type **y** and press **Enter** to save the new configuration.
 - Type **n** and press **Enter** to return to the Tuner Command prompt without changing the program configuration.

Configure Tuner/Output Assignments

This option enables you to reconfigure tuner/output assignments. Note that each tuner can only be assigned one output stream. If you remap an existing stream assignment to another tuner, the initial assignment will be disconnected.

For example: If Tuner 1 is currently streaming on Output 1, and Tuner 2 is remapped so that it is streaming on Output 1, the initial Tuner 1 assignment will be disconnected. If all tuners are currently assigned to output streams, Tuner 1 will now be assigned the output that was previously assigned to Tuner 2. If Tuner 2 initially had “no connection” status before it was remapped to Output 1, Tuner 1 will now have “no connection” status.

If you wish to remap an existing stream to another tuner, it is recommended that you first modify the output assignment of the stream in question to “no connection” before you reassign the stream as required.

(Continued on next page)

Configuration Options via Command Line (Cont.)

(Continued from previous page)

Note: If the system is set for RF 64-QAM output, the stream number prompt (see step 2) will allow only four stream options. Streams 1, 2, 3, and 4 are configured by default when 64-QAM output is used, though any four of the OAT100R tuners may be mapped to these streams.

1. At the `Tuner Command >` prompt, type **output** and press **Enter**.
2. At the `Enter output stream number (1-8 or 0 for no connect) [#]>` prompt, either:
 - Press **Enter** to accept the default value (i.e., the current setting) in square brackets.
 - Type **0** and press **Enter** to specify “no connection.”
 - Type in the appropriate stream number and press **Enter** to remap the tuner output to a different stream.

The system will display confirmation, for example:

```
Output stream remapped. Tuner is now streaming on output 2.
```

Note: You can run the “monitor” command, if desired, to review the system settings. Refer to “Monitor the System” on page 44 for further information.

Power the Tuner On or Off

At the `Tuner Command >` prompt, either:

- Type **on** and press **Enter** to power ON the tuner. The system will display confirmation, for example:

```
Powering on Tuner-1: OK
```

Note that the power ON process may take up to 90 seconds as tuner firmware is reloaded. If desired, you can track the tuner progress via the Tuner Menu “info” command (see “View Tuner Information” on page 43 for further information).

- Type **off** and press **Enter** to power OFF the tuner. The system will display confirmation, for example:

```
Powering off Tuner-1: OK
```

Reset the Tuner

1. At the `Tuner Command >` prompt, type **reset** and press **Enter**.

The system will prompt for confirmation:

```
Do you want to reset the Tuner? [y/n]:
```

2. Either:
 - Type **y** and press **Enter** to initiate an immediate reset of the tuner (i.e., resynchronize the tuner on the input stream). Note that a tuner reset may take up to 15 seconds.
 - Type **n** and press **Enter** to return to the Tuner Command prompt without resetting the tuner.

Configuration Options via Command Line (Cont.)

Exit the Tuner Menu

At the `Tuner Command >` prompt, type **exit** and press **Enter** to exit the Tuner Menu and return to the OAT100R Main Menu `Command >` prompt.

Setup Menu Commands

The following subsections describe how to access and use the Setup Menu commands.

Access the Setup Menu

1. Log in to the OAT100R as described on page 39.
2. At the `Command >` prompt, type **setup** and press **Enter**.
3. At the `Setup Command >` prompt, either:
 - Press **Enter** to display the Setup Menu (see example below).
 - Type the desired command and press **Enter**.

Note: You can always press **Enter** at the `Setup Command >` prompt to display the Setup Menu.

Example: Setup Menu

```
-----  
Setup Menu  
-----  
info          System information  
monitor       System monitor  
map           System program map  
omode         Set output mode  
pid           System PID configuration  
proidiom      Pro:Idiom configuration  
setip         Control port IP configuration menu  
rf            RF output configuration  
scan          Scan RF channels  
ipout         IP output configuration menu  
tz            Timezone setup  
time          Time setup  
pwd           Change password  
tundiag       Tuner Diagnostic  
location      Location description  
exit          Return to the main menu  
reset         System reset  
  
Setup Command >
```

Configuration Options via Command Line (Cont.)

View System Information

This option is also available from the OAT100R Main Menu.

At the `Setup Command >` prompt, type **info** and press **Enter**.

The System Information display identifies important information about the OAT100R, including the unit serial number, software version, hardware ID (firmware version), Control Port MAC and IP addresses, and output configuration. See sample display under the “View System Information” section on page 40.

It is recommended that you record this information for future reference. If you find it necessary to call customer service or engineering support, please have this information available.

Monitor the System

This option enables you to view static or dynamic system streaming data and is also available from the OAT100R Main Menu and the Tuner Menu.

At the `Setup Command >` prompt, either:

- Type **monitor** and press **Enter** to display the current system data (see sample display under the “Monitor the System” section on page 40).
- To monitor streaming data in real time, type **monitor** and the number of seconds before the data refreshes. Then, press **Enter**. For example, to refresh the data every second, type **monitor 1** and press **Enter**.

When you are finished monitoring streaming data, press **Enter** to stop the system monitor and return to the `Setup Command >` prompt.

View the System Program Map

This option enables you to display program assignments for each tuner and is also available from the OAT100R Main Menu and the Tuner Menu.

At the `Setup Command >` prompt, type **map** and press **Enter** to display the current system program assignments (see sample display under the “View the System Program Map” section on page 41).

Set the Output Mode

Note: If you reconfigure the system output from IP output to RF (256-QAM or 64-QAM) output all MUX and tuner settings will be reset to their default values. However, if you reconfigure the system output from RF 256-QAM output to IP output, MUX and tuner settings will be retained.

1. At the `Setup Command >` prompt, type **omode** and press **Enter**.

The system will display a list of the available output modes, followed by a prompt for the new output mode, for example:

(Continued on next page)

Configuration Options via Command Line (Cont.)

(Continued from previous page)

Available output modes:

- 1 - RF
- 2 - IP

Enter number of new output mode [1]>

2. At the prompt, either press **Enter** to accept the default value (i.e., the current setting) in square brackets, or type the number that corresponds to the appropriate output mode and press **Enter**.

The system will confirm your selection, for example:

```
Output mode is set: RF
```

3. Complete the appropriate configuration, depending on the output mode. Refer to “Configure the RF Output” on page 54 or “Configure the IP Output” on pages 56 to 59, as applicable.

Configure the Program PIDs

If any Pro:Idiom channels are configured in the site’s entertainment system, you must configure program PIDs for the OAT100R output. See “Packet Identifiers (PIDs) Overview” on page 10 for further information, and/or check with your service representative, if necessary.

1. At the `Setup Command >` prompt, type **pid** and press **Enter**.

The system displays an overview of the current PID configuration (including Pro:Idiom PIDs) followed by a prompt for the starting program PID, for example:

```
Current PID Configuration
```

```
Program PIDs range:      0x30 - 0x6f
Pro:Idiom PIDs range:   0x1050 - 0x1057
Send Pro:Idiom messages: no
```

```
Enter the starting program PID [0x30]:
```

2. At the prompt, type the new starting program PID in hexadecimal format, and then press **Enter**.

Note: The system will auto-increment the remaining 63 program PIDs from the starting PID.

Note: If any of the program PIDs conflicts with PIDs that have been set/reserved for Pro:Idiom, the system will display an error message and then return to the starting program PID prompt.

If you change the starting program PID, the system will display an overview of the new configuration and prompt for confirmation, for example:

(Continued on next page)

Configuration Options via Command Line (Cont.)

(Continued from previous page)

New PID Configuration

```
Program PIDs range:      0x31 - 0x70
Pro:Idiom PIDs range:    0x1050 - 0x1057
Send Pro:Idiom messages: no
```

Do you want to save the new configuration? [y/n]:

3. Either:

- Type **y** and press **Enter**, to save the new configuration. The system will confirm the configuration update:

```
New configuration has been saved.
```

- Type **n** and press **Enter** to return to the `Setup Command >` prompt without saving your changes.

Configure the Pro:Idiom PIDs

This option enables you to configure Pro:Idiom PIDs and enable/disable Pro:Idiom messages in the output stream. It is intended only for qualified service personnel and should only be used when recommended by LG. This option requires the Pro:Idiom user password. If this is the first time the command is being run, contact LG for the password; otherwise, if necessary, obtain the password from the system administrator.

1. At the `Setup Command >` prompt, type **proidiom** and press **Enter**.
2. At the `Enter Pro:Idiom user password: prompt`, type the password (case-sensitive) and press **Enter**.

The system displays an overview of the current PID configuration (including program PIDs) followed by a prompt for the starting Pro:Idiom PID, for example:

Current PID Configuration

```
Program PIDs range:      0x30 - 0x6f
Pro:Idiom PIDs range:    0x1050 - 0x1057
Send Pro:Idiom messages: no
```

Enter the starting Pro:Idiom PID [0x1050]:

3. At the prompt, either press **Enter** to accept the default value (i.e., the current setting) in square brackets, or type the appropriate starting Pro:Idiom PID in hexadecimal format, and then press **Enter**.
4. At the `Insert Pro:Idiom messages in output stream? (y/n) [n]: prompt`, either:
 - Type **y** and press **Enter** to enable Pro:Idiom messages in the output stream, or
 - Type **n** and press **Enter** to disable Pro:Idiom messages in the output stream.

(Continued on next page)

Configuration Options via Command Line (Cont.)

(Continued from previous page)

After you specify the Pro:Idiom messages setting, the system will display an overview of the new configuration and prompt for confirmation, for example:

```
New PID Configuration
```

```
Program PIDs range:      0x30 - 0x6f
Pro:Idiom PIDs range:    0x1051 - 0x1058
Send Pro:Idiom messages: no
```

```
Do you want to save the new configuration? [y/n]:
```

5. Either:

- Type **y** and press **Enter**, to save the new configuration. The system will confirm the configuration update:

```
New configuration has been saved.
```

- Type **n** and press **Enter** to return to the `Setup Command >` prompt without saving your changes.

Configure the Control Port

1. At the `Setup Command >` prompt, type **setip** and press **Enter**.

The system displays an overview of the current TCP/IP network configuration followed by the Network Configuration Menu, for example:

```
Current Network Configuration
```

```
Interface controller port
```

```
Host name:      oat100r
Using DHCP:     YES
```

```
DNS servers
```

```
Primary DNS:    68.94.156.1
Secondary DNS:  68.94.157.1
```

```
-----
Network Configuration Menu
-----
```

```
ip      Configure Control Port IP
dns     Configure DNS
exit    Exit network configuration
```

```
Choose item to modify >
```

(Continued on next page)

Configuration Options via Command Line (Cont.)

(Continued from previous page)

2. Either:

- Continue with step 3 for information on modifying the IP configuration of the Control Port.
- Go to step 8 for information on modifying the DNS configuration.
- To exit the Network Configuration Menu without modifying any settings, type **exit** at the Network Configuration Menu > prompt.

3. Type **ip** and press **Enter** to modify the configuration of the Control Port.

4. At the Host name [oat100r]: prompt, either press **Enter** to accept the default value in square brackets, or type a new host name and then press **Enter**.

5. At the Using DHCP (Y/N) [Y]: prompt, type **y** if the OAT100R uses DHCP, or type **n** to specify the network IP addresses. Then, press **Enter**.

6. If the OAT100R is NOT using DHCP, type the information requested at each of the following prompts. Press **Enter** after each entry.

This host IP address []: *(Type the host IP address in the format xxx.xxx.xxx.xxx.)*

Network mask []: *(Type the netmask in the format xxx.xxx.xxx.xxx.)*

Gateway IP address []: *(Type the IP address of the default gateway in the format xxx.xxx.xxx.xxx.)*

7. Once you enter the gateway IP address, the system will redisplay the Network Configuration Menu.

- To modify the DNS configuration, continue with step 8.
- If no additional network configuration is required, go to step 9.

8. To change the DNS configuration, type **dns** and press **Enter**.

At each of the following prompts, type the information requested. Press **Enter** after each entry.

Configuring DNS

Primary DNS IP address []:

Secondary DNS IP address []:

Once you enter the secondary DNS IP address, the system will redisplay the Network Configuration Menu. You can select another option to modify (see previous steps) or you can exit as described below.

9. When you are finished with network configuration, type **exit** at the Network Configuration Menu > prompt. The system will display an overview of the new network configuration and then prompt for confirmation to save the changes, for example:

(Continued on next page)

Configuration Options via Command Line (Cont.)

(Continued from previous page)

```
New Network Configuration
Interface controller port
Host name:          oat100r
Using DHCP:        NO
Host IP address:   10.166.60.92
Network mask:     255.255.255.0
Gateway IP address: 10.166.60.1

DNS servers
Primary DNS:       68.94.156.2
Secondary DNS:    68.94.157.2

Do you want to save the new configuration? (Y/N):
```

10. Type **y** or **n** and press **Enter**, as appropriate.

If you opt **NOT** to save the new configuration, the system will return immediately to the `Setup Command >` prompt. Otherwise, the system will confirm the configuration updates and prompt you to reset the system:

```
New configuration has been saved. Please restart the system.
```

11. If you are ready to reset the system immediately, at the `Setup Command >` prompt, type **reset** and press **Enter** (see “Reset the System” on page 64 for further information).

Note: If you intend to modify additional configuration settings during the current session, you may wait until all changes are complete before you reset the system.

Configure the RF Output

This option enables you to specify the appropriate RF channels for your location. See “Channel Assignments for RF Output” on pages 8 and 9, and/or check with your service representative, if necessary.

Note: Ensure the output mode also has been set accordingly. See “Set the Output Mode” on page 49 for further information.

Note: If you reconfigure the system output from 256-QAM output to 64-QAM output all MUX and tuner settings will be reset to their default values.

1. At the `Setup Command >` prompt, type **rf** and press **Enter**.

The system displays a list of the RF mode options and prompts for a selection:

```
RF Setup
Available RF modes are:
1) RF: OFF
2) 256-QAM-B, RF: 6 MHz, 5.36 MSps (default)
3) 64-QAM-B, RF: 6 MHz, 5.06 MSps
```

(Continued on next page)

Configuration Options via Command Line (Cont.)

(Continued from previous page)

Select a new RF mode [2]:

2. At the prompt for the RF mode, either:

- Type **1** and press **Enter** to disable RF output.
- Type **2** and press **Enter** to enable 256-QAM output.
- Type **3** and press **Enter** to enable 64-QAM output.

Note: You can simply press **Enter** if the default shown in square brackets is the correct option for this system.

3. If you selected either of the QAM-B (256-QAM or 64-QAM) options in step 2, the system will prompt next for an RF channel number (i.e., the RF start channel number):

Enter a new RF channel [2]:

At the prompt, either press **Enter** to accept the default value in square brackets, or type a new RF start channel number and then press **Enter**.

4. At the Enter number of channels [4]: prompt, either press **Enter** to accept the default value in square brackets, or type the applicable number of channels (Maximum = 4).

Once you specify the RF setup, the system displays an overview of the settings, for example:

```
RF config: Mode 2, 256-QAM-B, RF: 6 MHz, 5.36 MSps
RF channels: 7 8 9 10
```

Scan for RF Channels

This option enables you to select up to two tuners at a time and initiate a scan for all available off air RF channels.

Note: If multiple tuners are connected to one antenna, you do not need to run separate RF scans on each.

Note: If the system is set for RF 64-QAM output, up to four tuners can be used at a time. Make sure the tuners to be scanned have been mapped to streams (see “Configure Tuner/Output Assignments” on page 46); otherwise, the RF scan(s) will not find any channels.

1. At the Setup Command > prompt, type **scan** and press **Enter**.

The system will prompt for confirmation, for example:

A channel scan takes several minutes to complete.

During that time, the scanning tuner(s) will not stream normally.

Do you want to scan for RF channels now? [y/n]:

(Continued on next page)

Configuration Options via Command Line (Cont.)

(Continued from previous page)

2. At the prompt for confirmation, either:
 - Type **y** and press **Enter** if you want to run an RF scan. Continue with step 3.
 - Type **n** and press **Enter** to return to the Setup Command prompt without scanning for RF channels.
3. At the `Enter tuner for VHF scan [1] >` prompt, either press **Enter** to accept the default value in square brackets, or type the number of the tuner on which to run the VHF scan, and then, press **Enter**.
4. At the `Enter tuner for UHF scan [1] >` prompt, either press **Enter** to accept the default value in square brackets, or type the number of the tuner on which to run the UHF scan, and then, press **Enter**.

Once you specify the tuner for the UHF scan, the system will display the following reminder before initiating the scan:

```
This will take several minutes to complete. Please be patient.
```

When the scan is complete, the system displays a listing of the channels and programs found for the selected tuner(s), for example:

```
Channel scan completed successfully.
Scan found a total of 9 channels.
    Channel 7 programs: 1 2 3
    Channel 17 programs: 3 5
    Channel 19 programs: 3 4
    Channel 21 programs: 1 2 3
    Channel 27 programs: 3 4 5 6 7
    Channel 36 programs: 1 2 4
    Channel 43 programs: 3 4 5 100 101 200 209 300 301 302
    Channel 44 programs: 1 2 3
    Channel 47 programs: 3 4 5 6 7 8
```

Configure the IP Output

IP Output Configuration Menu options enable you to view and/or modify the IP output configuration for your system. Each of the menu options is described on the pages that follow.

Note: Ensure the output mode also has been set accordingly. See “Set the Output Mode” on page 49 for further information.

Access the IP Output Configuration Menu

1. At the `Setup Command >` prompt, type **ipout** and press **Enter**.
2. At the `IP Output Command >` prompt, either:
 - Press **Enter** to display the IP Output Configuration Menu (see example on following page).
 - Type the desired command and press **Enter**.

Configuration Options via Command Line (Cont.)

Example: Output IP Configuration Menu

```
-----  
IP Output Configuration Menu  
-----  
display    Display output IP configuration  
set        Configure output IP channel  
fill       Fill IP configuration with autoincrement IP  
ttl        Set the multicast TTL *  
apply      Apply the new IP configuration  
exit       Return to the Setup Menu
```

IP Output Command >

Display Output IP Configuration

1. At the IP Output Command > prompt, type **display** and press **Enter** to view the current output configuration, for example:

N	IP Address	Port
1-1	227.0.0.0	1234
2-1	227.0.0.2	1234
3-1	227.0.0.4	1234
4-1	227.0.0.6	1234
5-1	227.0.0.8	1234
6-1	227.0.0.10	1234
7-1	227.0.0.11	1234
8-1	227.0.0.12	1234

TTL: 1

Note: The multicast TTL is displayed only if the OAT100R software is version 2.0 or later.

2. At the IP Output Command > prompt, type **exit** and press **Enter** to return to the Setup Menu when you are finished reviewing the display.

Manually Configure Output IP Channels

This option enables you to specify the multicast IP address and port number for each program. Each program must be assigned a unique IPv4 multicast address. See "Channel Assignments for IP Output" on page 9, and/or check with your service representative, if necessary.

Note: If you wish to set a base multicast IP address and have the system auto-increment the remaining program data, use the "fill" option described below.

1. At the IP Output Command > prompt, type **set** and press **Enter**.

(Continued on next page)

* Available only with OAT100R version 2.0 or later software.

Configuration Options via Command Line (Cont.)

(Continued from previous page)

2. At the `Enter Tuner number [#]>` command, either press **Enter** to accept the default value in square brackets, or type the appropriate tuner number and press **Enter**.
3. At the `Enter multicast IP address [227.0.0.0]:` command, either press **Enter** to accept the default value in square brackets, or type the appropriate multicast IP address for this stream and press **Enter**.
4. At the `Enter new multicast port [1234]>` command, either press **Enter** to accept the default value in square brackets, or type the appropriate port number for the multicast stream and press **Enter**.
5. After you type the port number, the system returns to the `IP Output Command >` prompt. To configure additional IP channels, repeat steps 1 to 4.

When you have set all output IP channels as required, continue with step 6.

6. (Optional) Use the Output IP Configuration Menu `"ttl"` command to set the multicast TTL, as necessary. See "Set the Multicast TTL" on the following page for further information. After you enter the TTL, the system returns to the `IP Output Command >` prompt.

Note: The option to set the TTL is available only with OAT100R version 2.0 or later software. If a router is not being used on the system, leave the TTL set to 1 (default).

7. At the `IP Output Command >` prompt, type **apply** and press **Enter** to confirm and apply the configuration data to the system.

The system will display confirmation before returning to the `IP Output Command >` prompt, for example:

```
New IP outputs configuration is now active.
```

8. At the `IP Output Command >` prompt, type **exit** and press **Enter** to return to the Setup Menu.

Auto-configure Output IP Channels

This option enables you to have the system auto-increment the output IP channels from a base multicast IP address and port number. Each program must be assigned a unique IPv4 multicast address. See "Channel Assignments for IP Output" on page 9, and/or check with your service representative, if necessary.

Note: If you wish to manually configure each IP channel, use the "set" option described above.

1. At the `IP Output Command >` prompt, type **fill** and press **Enter**.
2. At the `Enter base multicast IP address [227.0.0.0]:` command, either press **Enter** to accept the default value in square brackets, or type the appropriate base multicast IP address and press **Enter**.

(Continued on next page)

Configuration Options via Command Line (Cont.)

(Continued from previous page)

3. At the `Enter new multicast port [1234]` prompt, either press **Enter** to accept the default value in square brackets, or type the appropriate port number for the multicast streams and then press **Enter**.
4. After you type the port number, the system returns to the `IP Output Command >` prompt.
5. (Optional) Use the Output IP Configuration Menu “ttl” command to set the multicast TTL, as necessary. See “Set the Multicast TTL” below for further information. After you enter the TTL, the system returns to the `IP Output Command >` prompt.

Note: The option to set the TTL is available only with OAT100R version 2.0 or later software. If a router is not being used on the system, leave the TTL set to 1 (default).

6. At the `IP Output Command >` prompt, type **apply** and press **Enter** to confirm and apply the configuration data to the system.

The system will display confirmation before returning to the `IP Output Command >` prompt, for example:

```
New IP outputs configuration is now active.
```

7. At the `IP Output Command >` prompt, type **exit** and press **Enter** to return to the Setup Menu.

Set the Multicast TTL

This option enables you to specify the number of hops allowed before the multicast data is dropped. If a router is being used on the system, the TTL value should be the number of router hops + 1. If a router is not being used, leave the TTL set to 1 (default).

Note: The “ttl” command is available only with OAT100R version 2.0 or later software.

1. At the `IP Output Command >` prompt, type **ttl** and press **Enter**.
2. At the `Enter new multicast TTL [1]>` prompt, type the new TTL value and press **Enter**.
3. Make sure to use the Output IP Configuration Menu “apply” command to confirm and apply any update to the system. See also “Apply IP Output Configuration” below.

Apply IP Output Configuration

If you make any changes to the IP output configuration, you must use this command to confirm and apply the configuration to the system. At the `IP Output Command >` prompt, type **apply** and press **Enter** to confirm and apply the configuration data to the system.

The system will display confirmation before returning to the `IP Output Command >` prompt, for example:

```
New IP outputs configuration is now active.
```

Configuration Options via Command Line (Cont.)

Set the Time Zone

Note: See “Set the Date and Time” on the following page for information on setting the date and time for the OAT100R.

1. At the `Setup Command >` prompt, type **tz** and press **Enter**.

The system displays the current time zone information for the OAT100R and prompts you to specify whether or not you wish to change the time zone.

```
Current time zone is: America/New York
Change the time zone? [y/n]:
```

2. Either:

- Type **n** and press **Enter** to return to the `Setup Command >` prompt without changing the current time zone.
- Type **y** and press **Enter** to change the time zone. Then, continue with step 3.

3. The system will display the following prompt for a location, followed by a list of options:

```
Please identify a location so that time zone rules can be set correctly.
Please select a continent or ocean.
```

At the `#?` prompt, type the number that corresponds to the appropriate option for your location, and then press **Enter**.

4. The system will display the following prompt for a country, followed by a list of options:

```
Please select a country.
```

At the `#?` prompt, type the number that corresponds to the appropriate option for your country, and then press **Enter**.

5. The system will display the following prompt for a region, followed by a list of options:

```
Please select one of the following time zone regions.
```

At the `#?` prompt, type the number that corresponds to the appropriate option for your region, and then press **Enter**.

After you specify the time zone region, the system displays an overview of your location selections and prompts for confirmation, for example:

```
The following information has been given:
```

```
United States
Central Time
```

```
Therefore TZ='America/Chicago' will be used.
```

```
Local time is now: Tue Jan 8 16:23:10 CST 2014.
```

```
Universal Time is now: Tue Jan 8 22:23:10 UTC 2014.
```

```
Is the above information OK?
```

```
1) Yes
```

```
2) No
```

```
#?
```

(Continued on next page)

Configuration Options via Command Line (Cont.)

(Continued from previous page)

6. Either:

- Type **1** and press **Enter** if the information in the display is correct. The system will confirm the setting and then prompt you to reset the OAT100R:

```
Time zone has been set. Please reset the system.
```

Continue with step 7.

- Type **2** and press **Enter** to return to the initial location prompt and reset the time zone (repeat this procedure from step 3).

7. If you are ready to reset the system immediately, at the `Setup Command >` prompt, type **reset** and press **Enter** (see “Reset the System” on page 64 for further information).

Note: If you intend to modify additional configuration settings during the current session, you may wait until all changes are complete before you reset the system.

Set the Date and Time

By default, the OAT100R is synchronized with an NTP server and configured for the US Central time zone. If the OAT100R is connected to the Internet, the NTP client will periodically update the time setting on the OAT100R. If the OAT100R is not connected to the Internet, you also have the option to disable NTP synchronization and specify date and time data manually. Refer to “Set the Time Zone” above for information on setting the time zone.

1. At the `Setup Command >` prompt, type **time** and press **Enter**.

2. At the `Use NTP for time synchronization (Y/N) ? [Y]:` prompt, either:

- Type **y** and press **Enter** if you intend to use an NTP client for time synchronization.

```
At the Enter new NTP server IP: [64.90.182.55]: prompt, either press Enter
to accept the default value in square brackets, or type the appropriate NTP server IP
address and press Enter.
```

The system will display confirmation, for example:

```
Time will now be synchronized via NTP from server: xxx.xxx.xxx.xxx
(where xxx.xxx.xxx.xxx is the NTP server IP address you provided above)
```

- Type **n** and press **Enter** to set the time manually.

The system will display the current time, for example:

```
Current time: 2014-01-08 18:49:56
```

and then initiate a series of prompts to enable you to set the time. Continue with step 3.

3. At each of the following prompts, type the year, month, and day, respectively. Note that all three of these fields require numerical values. Press **Enter** after each entry.

(Continued on next page)

Configuration Options via Command Line (Cont.)

(Continued from previous page)

If applicable, you can also press **Enter** at each prompt to accept the default value in square brackets.

```
Enter new year [2014]>
Enter new month [01]>
Enter new day [08]>
```

4. At each of the following prompts, type the hour and minute, respectively. Note that the hour should be entered in 24-hour format. Press **Enter** after each entry.

If applicable, you can also press **Enter** at each prompt to accept the default value in square brackets.

```
Enter new hour [18]>
Enter new minute [49]>
```

5. The system will display the new time and then prompt for confirmation, for example:

```
New time: 2014-01-08 18:53:00
Apply? [y/n]
```

Either, type **y** and press **Enter** to apply the new configuration to the system, or type **n** and press **Enter** to return to the `Setup Command >` prompt without changing the time configuration.

If you do apply new manual configuration, the system will display confirmation, for example:

```
New time is set
```

Change the Login Password

For security purposes, it is recommended that the admin user login password be unique to the system. Note that the login password is case-sensitive.

1. At the `Setup Command >` prompt, type **pwd** and press **Enter**.

The system prompts for the current admin user password:

```
Changing password for admin
Old password:
```

2. Type the current password and press **Enter**. The system will then prompt you to type and retype the new password:

```
New password:
Retype password:
```

3. Type and then retype the new password at the prompts. Press **Enter** after each entry.

Once you complete the Password fields successfully, the system displays confirmation:

```
Password for admin changed by admin.
```

Configuration Options via Command Line (Cont.)

Run a Tuner Diagnostic

This command enables you to run a diagnostic test on all OAT100R tuners.



Caution: The tuner diagnostic requires that all tuners be switched to a known good channel for testing purposes. Thus, standard system operation will be disrupted for the duration of the routine (up to five minutes).



Caution: If there is not a known good channel that is appropriate for each of the tuners, note in advance that the tuner(s) for which the channel is not valid will fail the diagnostic.

1. At the `Setup Command >` prompt, type **tundiag** and press **Enter**.
2. At the `Enter channel [2] >` prompt, either press **Enter** to accept the default value in brackets, or type in the number of a known good channel to test and press **Enter**.

The system will prompt for confirmation:

This is a diagnostic routine that may only be run in a controlled environment such as the factory.

Are you sure you want to continue (y/n)? [y/n]:

3. Either:
 - Type **y** and press **Enter** to initiate the diagnostic routine. When testing is complete, the system will display a results screen (see example below).
 - Type **n** and press **Enter** to return to the Setup Menu command without running the tuner diagnostic.

Example: Tuner Diagnostic Results

Tuner	Lock	FEC_ERR	LVL	SNR	Bitr	P/F
1	Yes	0	0	0	15.7	Pass
2	No	1	0	0	0.0	Fail
3	Yes	0	0	0	18.4	Pass
4	Yes	0	0	0	16.3	Pass
5	Yes	0	0	0	18.6	Pass
6	Yes	0	0	0	17.0	Pass
7	No	2	0	0	0.0	Fail
8	Yes	0	0	0	18.2	Pass

Configuration Options via Command Line (Cont.)

Identify the Site Location

This option enables you to identify the site in which the OAT100R is installed. If specified as described below or in the GUI System Setup screen, the site location is identified as part of the System Information display (available from the Main Menu and Setup Menu).

1. At the `Setup Command >` prompt, type **location** and press **Enter**.
2. At the `Enter Location Description:` prompt, type a brief description of the location. Then, press **Enter**.

The system will prompt for confirmation:

```
Are you sure you want to set the location description? [y/n]:
```

3. Either:
 - Type **y** and press **Enter** to confirm. The system will display confirmation, for example:

```
Location description has been set.
```
 - Type **n** and press **Enter** to return to the Setup Command prompt without specifying a location.

Exit the Setup Menu

At the `Setup Command >` prompt, type **exit** and press **Enter** to exit the Setup Menu and return to the OAT100R Main Menu `Command >` prompt.

Reset the System

This command is also available from the OAT100R Main Menu.

1. At the `Setup Command >` prompt, type **reset** and press **Enter**.
The system will prompt for confirmation:

```
Are you sure you want to reset the system? [y/n]:
```
2. Either:
 - Type **y** and press **Enter** to initiate an immediate reset of the OAT100R. The reset process, during which each of the tuners will also be reinitialized, may take up to two minutes, after which the system resumes normal operation.
 - Type **n** and press **Enter** to return to the Setup Command prompt without resetting the system.

Configuration Options via Command Line (Cont.)

Update Menu Commands

The following subsections describe how to access and use the Update Menu commands.

Access the Update Menu

1. Log in to the OAT100R as described on page 39.
2. At the `Command >` prompt, type **update** and press **Enter**.
3. At the `Update Command >` prompt, either:
 - Press **Enter** to display the Update Menu (see example below).
 - Type the desired command and press **Enter**.

Note: You can always press **Enter** at the `Update Command >` prompt to display the Update Menu.

Example: Update Menu

```
-----  
Update Menu  
-----  
update      Update  
updser      Update via serial link  
ucfg        Configure update server  
exit        Return to the main menu  
  
Update Command >
```

Update OAT100R Firmware via Ethernet

This option enables you to update OAT100R firmware via the Ethernet. The appropriate update file must be provided by LG; the system will not download an improper file.

Note: See “Update OAT100R Firmware via Serial Link” on the following page for information on updating firmware via a serial link.

1. At the `Update Command >` prompt, type **update** and press **Enter**.
2. At the `Enter update file name:` prompt, type in the firmware update filename and press **Enter**.

The system will initiate the download and confirm progress, for example:

```
Downloading file: oat100r_app_xxxx.upd
```

3. When the update is successfully completed, exit the Update Menu and reset the system (see “Reset the System” on page 67 for further information).

Configuration Options via Command Line (Cont.)

Update OAT100R Firmware via Serial Link

This option enables you to update OAT100R firmware via a serial link to the OAT100R. The appropriate update file must be provided by LG; the system will not transfer an improper file.

Note: See “Update OAT100R Firmware via Ethernet” above for information on updating firmware via the Ethernet.

1. At the `Update Command >` prompt, type **updser** and press **Enter**.
2. At the `Send file using XMODEM` prompt, transfer the firmware update file using Xmodem protocol. For example, in HyperTerminal, select **Transfer** and then **Send File...** In the Send File window, enter or select the appropriate filename in the Filename field, and select **Xmodem** in the Protocol field.

The system will display progress messages as well as the result of the update process (which may take several minutes).

3. When the update is successfully completed, exit the Update Menu and reset the system (see “Reset the System” on page 67 for further information).

Configure the Update Server

1. At the `Update Command >` prompt, type **ucfg** and press **Enter**.
2. At the `Enter update protocol (ftp or tftp) [ftp]:` prompt, either press **Enter** to accept the default value (i.e., the current setting) in square brackets or type the new update protocol to use (ftp or tftp) and press **Enter**.
3. At the `Enter update host IP address [xxx.xxx.xxx.xxx]:` prompt, either press **Enter** to accept the default value in square brackets, or type the IP address of the OAT100R and press **Enter**.
4. (FTP only) At the `Enter update user name [update]:` prompt, type the name for the update user.
5. (FTP only) At the `Enter update user password [update]:` prompt, type the password for the update user.

Exit the Update Menu

At the `Update Command >` prompt, type **exit** and press **Enter** to exit the Update Menu and return to the OAT100R Main Menu `Command >` prompt.

Configuration Options via Command Line (Cont.)

Reset the System

Note: This option is also available from the Setup Menu.

1. If not already logged in, log in to the OAT100R as described on page 39.
2. At the Main Menu `Command >` prompt, type **reset** and press **Enter**.

The system will prompt for confirmation:

```
Are you sure you want to reset the system? [y/n]:
```

3. Either:
 - Type **y** and press **Enter** to initiate an immediate reset of the OAT100R. The reset process, during which each of the tuners will also be reinitialized, may take up to two minutes, after which the system resumes normal operation.
 - Type **n** and press **Enter** to return to the Command prompt without resetting the system.

Exit the Current Session

At the Main Menu `Command >` prompt, type **exit** and press **Enter** to end the current session.

Troubleshooting

OAT100R Setup

The following sections provide basic troubleshooting information for the OAT100R.

Equipment Setup Review

- Make sure all connectors and connections are tight and secure on all entertainment system components.
- Check the OAT100R PWR LED. Under standard operating conditions, the PWR (Power) LED on the OAT100R front panel is continuously lit green. If there is a hardware fault, the PWR LED will turn and stay red.

Note: When power is first applied to the OAT100R, the PWR LED initially flashes red and then turns green.

- Check the OAT100R STATUS LED. When the OAT100R is booted and operating normally, the STATUS LED is continuously lit green.

Network Setup

If the network is configured for DHCP but the OAT100R has not been assigned an IP address, i.e., the Ctrl IP field in the OAT100R System Information display is blank:

1. Check the Control Port connector on the rear panel of the OAT100R. Make sure the cable connection is tight and secure.
2. Observe the green LED on the Control Port. Once the OAT100R is connected to the network, the LED will be lit continuously.
3. Contact the network administrator to verify the network status and check that the DHCP server is working properly.

Troubleshooting (Cont.)

OAT100R Communication

If you are unable to establish communication with the OAT100R either via the web GUI or the command line interface, refer to the following flow chart.

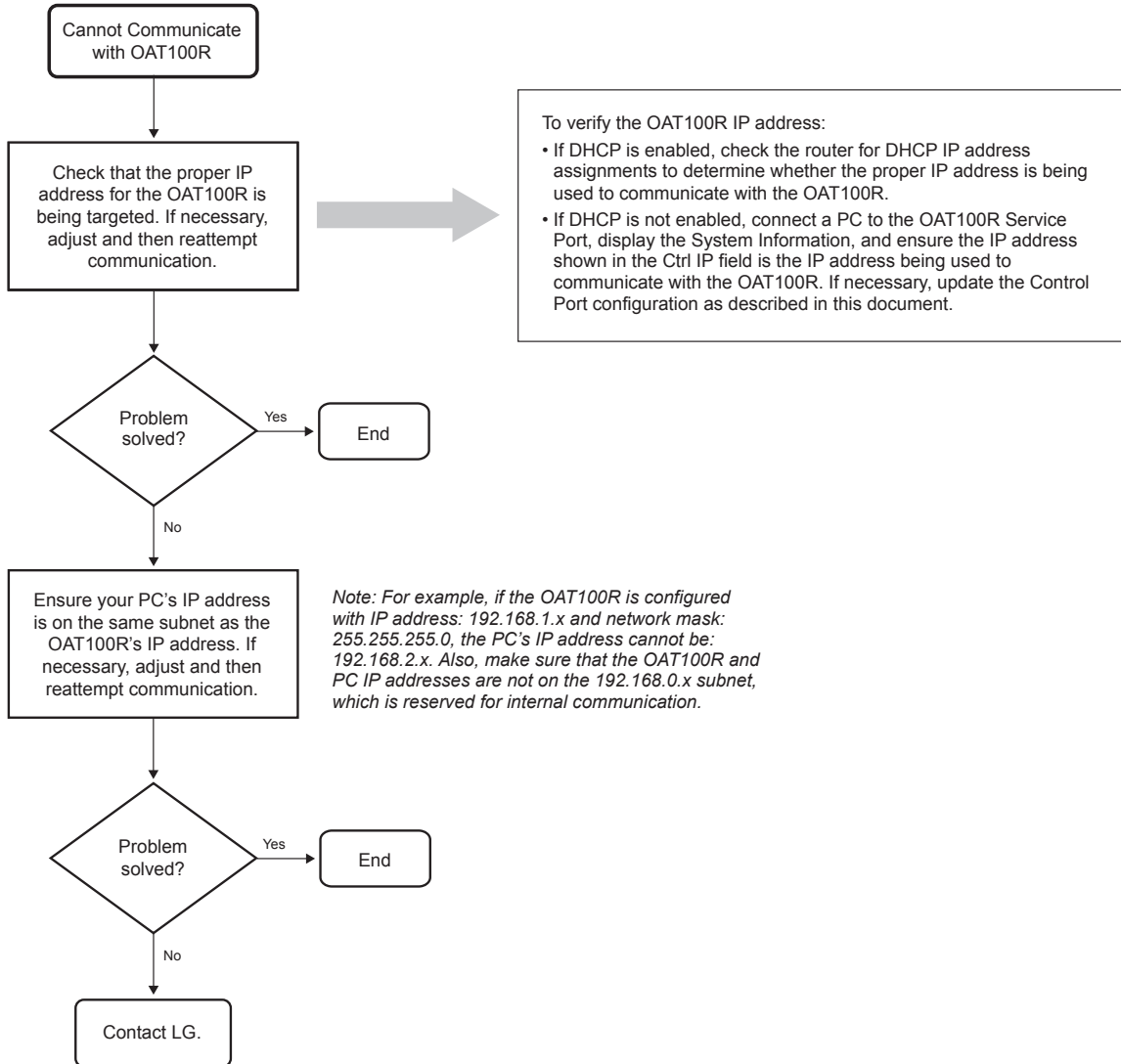

Troubleshooting (Cont.)

Receiver Reception

If one or more receivers have symptoms of broken audio or video or no signal, refer to the troubleshooting flow charts below and on the following pages. If necessary, contact LG for additional troubleshooting help.

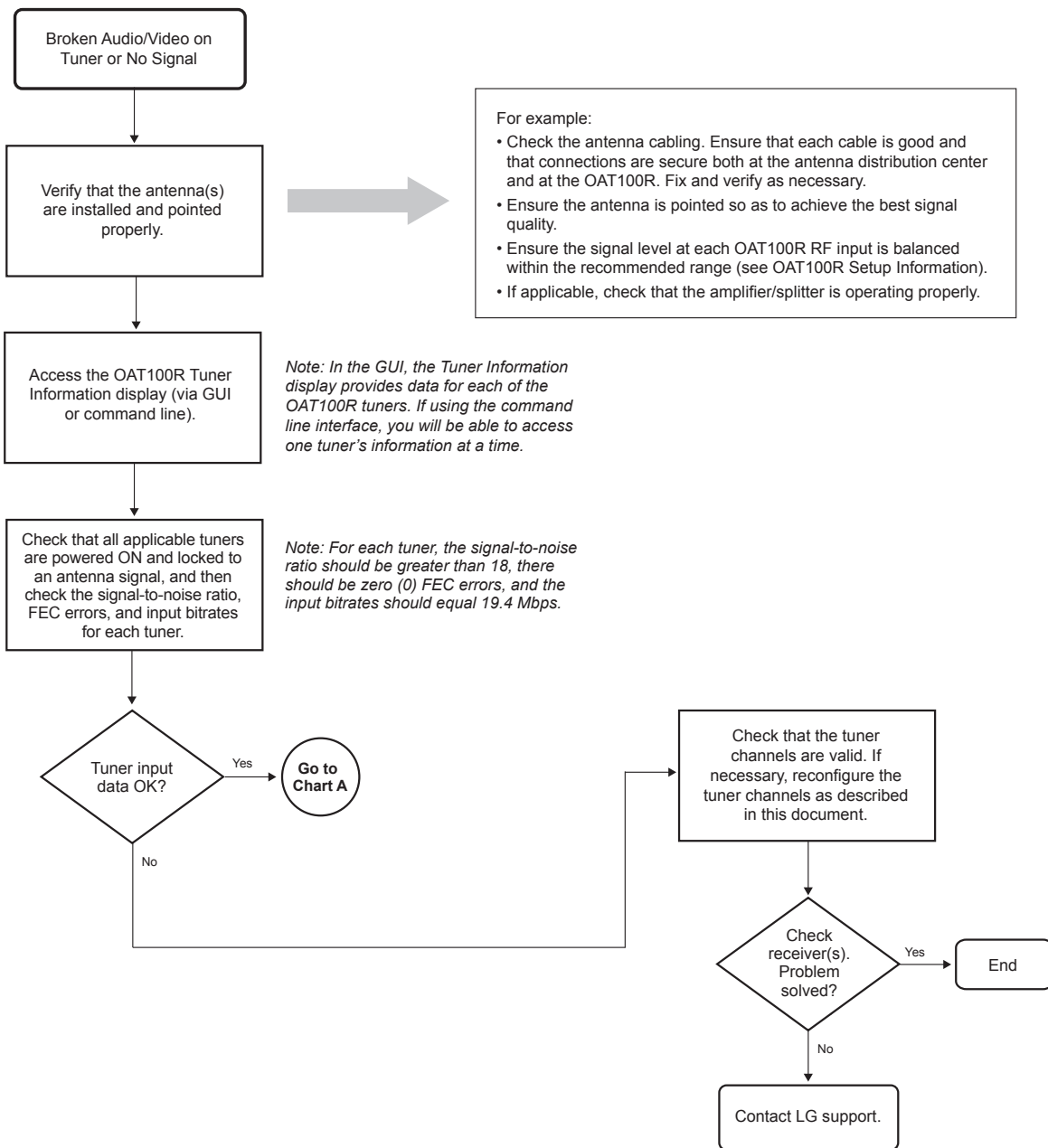

Troubleshooting (Cont.)

Receiver Reception (Cont.)

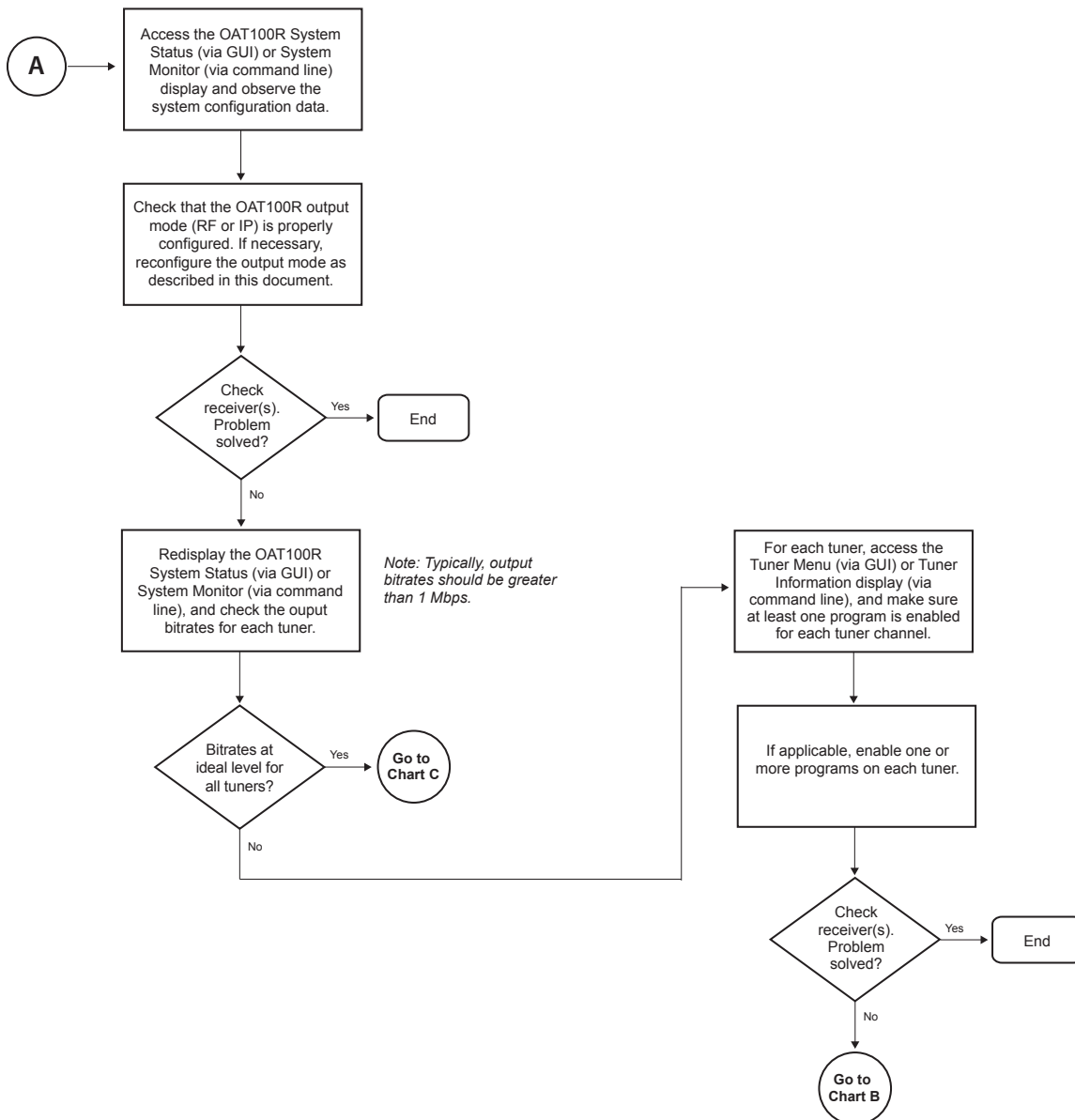

Troubleshooting (Cont.)

Receiver Reception (Cont.)

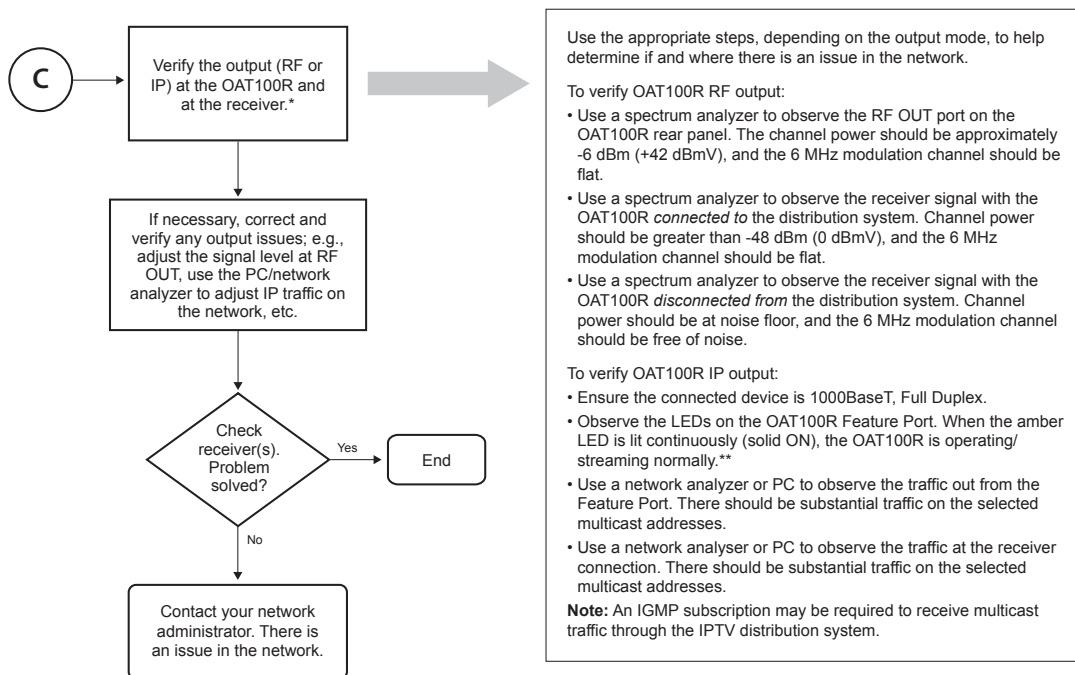
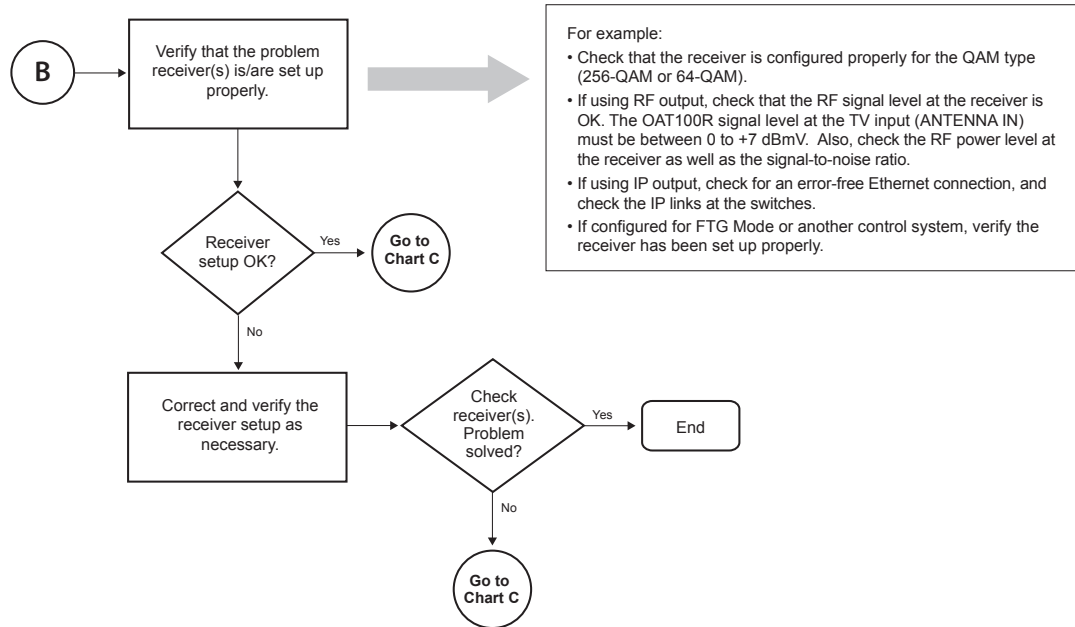

* This chart assumes the OAT100R output mode (RF or IP) is properly configured (see Chart A).

** If the green LED is lit, there is a viable connection to the IP distribution network, but no traffic. If the amber LED is blinking, there is intermittent traffic, but no streaming.

Specifications

Dimensions

Height: 1.692 inches (42.977 mm)
Width: 19.0 inches (482.6 mm) with mounting brackets attached
(for EIA standard 19-inch rack mount)
Depth: 8.5 inches (215.9 mm)
Weight: 4.45 pounds (2.02 kgrms) rack-only weight

Environmental Storage Conditions

Temperature: -20° to 70° Celsius
-4° to 158° Fahrenheit
Humidity: 95% non-condensing

Environmental Operating Conditions

Temperature (Tma): 0° to 40° Celsius
32° to 104° Fahrenheit
Humidity: 95% non-condensing

Electrical

RF Out Connector: Type 'F'
RF Output Span: 4 Contiguous Channels (typically 24 MHz)
RF Output Frequency Range: 54 MHz to 864 MHz
Active Output Level at RF Out jack: -6 dBm (+42 dBmV) Min.

RF IN Ports (8): Type 'F', 75 Ohm
RF Input Frequency Range: Terrestrial Channels 2 to 69
RF Input Signal Level: +3 dBm (+52 dBmV) to -83 dBm (-34 dBmV)
RF Input Signal-to-Noise Ratio: >17 dB

DC Input: +12V DC @ 2.6 Amps

Ethernet Connector (Control Port): 10/100/1000BaseT, RJ-45
Ethernet Connector (Feature Port): 1000BaseT Full Duplex, RJ-45

USB Port: USB 2.0

Note: Design and specifications subject to change without prior notice.

Document Revision History / Notes

Document Revision History

Date	Description
October 2012	Revision A: New document
January 2013	Revision B: Features list update
July 2013	Revision C: IP output configuration/TTL updates
February 2014	Revision D: RF input SNR, admin user password updates

Product documentation is available online at: www.LGolutions.com.

Notes

Open Source Software Notice

Product Type	Off Air Transcoder System
Model Number/Range	OAT100R

Those products identified by the Product Type and Model Range above from LG Electronics, Inc. ("LGE") contain the open source software detailed below. Please refer to the indicated open source licences for the terms and conditions of their use.

Components	License
bash, busybox, das u-boot, e2fsprogs, ethtool, gawk, i2c-ocores, iptables, linux kernel, lrzsz, lzo, mtd-utils, net-tools, ntpclient, openvpn, pciutils, ppp, procps, screen, skell, time	GPL 2.0
eglibc, libelf, termcap	LGPL 2.0/2.1

The source code and other important information for the above may be obtained free of charge from LGE at <http://opensource.lge.com>. LGE will also provide open source code to you on CD-ROM for a charge covering the cost of performing such distribution (such as the cost of media, shipping and handling) upon e-mail request to opensource@lge.com. This offer is valid for three (3) years from the date on which you purchased the product.

Please be informed that LG Electronics products may contain open source software listed in the table below.

Components	License
openssh	OpenSSH License
OpenSSL	OpenSSL License
sudo	sudo License

LG CodePlus OAT100R Warranty

Broadcast Products Welcome to the LG family! We believe that you will be pleased with your new CodePlus OAT100R Off Air Transcoder System. Please read this warranty carefully, it is a "LIMITED WARRANTY" as defined under Federal Law. This warranty gives you specific legal rights, and you may also have other rights that vary from state-to-state within the U.S.A.

LG's RESPONSIBILITY

- Warranty Term** One year parts and labor from date of purchase or delivery date.
- Parts** New or remanufactured replacements for factory-defective parts may be used. Such replacement parts are warranted for the remaining portion of the original warranty period.
- Warranty Service** Warranty service is provided at LG. Customer pays for shipping charges to LG; LG pays for return shipping charges to return OAT100R to customer. Call **1-888-865-3026** for further information.
- Not Covered** This warranty covers manufacturing defects and does not cover installation, adjustment of customer controls, installation or repair of antenna systems, cable converters or cable company-supplied equipment; it also does not cover damage due to misuse, abuse, negligence, acts of God or other causes beyond the control of LG. Any alteration of the product after manufacture voids this warranty in its entirety.

THIS WARRANTY IS IN LIEU OF ANY OTHER WARRANTY, EXPRESS OR IMPLIED, INCLUDING WITHOUT LIMITATION, ANY WARRANTY OF MERCHANTABILITY OR FITNESS FOR A PARTICULAR PURPOSE, AND LG SHALL NOT BE LIABLE FOR ANY CONSEQUENTIAL, INDIRECT, OR INCIDENTAL DAMAGES OF ANY KIND, INCLUDING LOST REVENUES OR PROFITS IN CONNECTION WITH THIS PRODUCT. SOME STATES DO NOT ALLOW LIMITATIONS ON HOW LONG AN IMPLIED WARRANTY LASTS OR THE EXCLUSION OR LIMITATION OF INCIDENTAL OR CONSEQUENTIAL DAMAGES, SO THE ABOVE LIMITATIONS OR EXCLUSIONS MAY NOT APPLY TO YOU.

OWNER'S RESPONSIBILITY

- Effective Warranty Date** Warranty begins on the date of delivery of the OAT100R.
For your convenience, keep the dealer's dated bill of sale or delivery ticket as evidence of the purchase date.
- Installation Guide** Read the Installation & Setup Guide carefully so that you will understand the operation of the OAT100R and how to adjust the settings.
- Warranty Service** **For warranty service information, call 1-888-865-3026.** Parts and service labor that are LG's responsibility (see above) will be provided without charge. Other service is at the owner's expense. If you have any problem in obtaining satisfactory warranty service, call **1-888-865-3026**.
You must provide the model number, serial number and date of purchase or date of original installation.

For Customer Support/Service, please call:

1-888-865-3026

www.LGsolutions.com

CodePlus is a trademark of LG Electronics U.S. A., Inc. Pro:Idiom is a registered trademark of Zenith Electronics LLC. All other trademarks or registered trademarks are the property of their respective owners.

Free Manuals Download Website

<http://myh66.com>

<http://usermanuals.us>

<http://www.somanuals.com>

<http://www.4manuals.cc>

<http://www.manual-lib.com>

<http://www.404manual.com>

<http://www.luxmanual.com>

<http://aubethermostatmanual.com>

Golf course search by state

<http://golfingnear.com>

Email search by domain

<http://emailbydomain.com>

Auto manuals search

<http://auto.somanuals.com>

TV manuals search

<http://tv.somanuals.com>