

**INSTALLATION INSTRUCTIONS**

**WARNINGS AND CAUTIONS:**

- To be installed and/or used in accordance with appropriate electrical codes and regulations.
- If you are unsure about any part of these instructions, consult a qualified electrician.
- Vizia™ RF electronic switches are not compatible with standard 3-way or 4-way switches. They must be used with compatible Vizia™ or Vizia™ RF controllers.
- Recommended minimum wall box depth is 2-1/2".

**WARNINGS AND CAUTIONS:**

- Use only one (1) Vizia™ RF electronic switch in a multi-location circuit with up to 9 Vizia™ coordinating remotes without LEDs or Vizia™ RF remotes for multi-location.
- Maximum wire length from dimmer to all installed remotes cannot exceed 300 ft (90 m).
- Disconnect power at circuit breaker or fuse when servicing, installing or removing fixture.
- Use this device only with copper or copper clad wire. With aluminum wire use only devices marked CO/ALR or CU/AL.

**INTRODUCTION**

Leviton's Vizia™ RF Z-Wave™ components are designed to communicate with each other via Radio Frequency (RF) to provide remote control of your lighting. Using RF technology allows Leviton to provide the greatest signal integrity possible. Each module in Leviton's Vizia™ RF component line is a Z-Wave™ enabled device. In a Z-Wave™ network, each device is designed to act as a router. These routers will re-transmit the RF signal from one device to another until the intended device is reached. This ensures that the signal is received by its intended device by routing the signal around obstacles and radio dead spots. The Scene Capable Plug-In Appliance Module is compatible with any Z-Wave™ enabled network, regardless of the manufacturer and can also be used with other devices displaying the Z-Wave™ logo.

**CAUTION:**

Remember to exercise good common sense when using the Timer features of your Remote – especially when scheduling unattended devices. There can be some unexpected consequences if not used with care. For example, an empty coffee pot can be remotely turned on. If that should happen, your coffee pot could be damaged from overheating. If an electric heater is turned on by remote control while clothing is draped over it, a fire could result. **DO NOT USE** the remote for the control of high power heating appliances such as portable heaters. This device will not control lighting that is used with electronic low-voltage and high frequency power supply transformers, nor high pressure discharge lamps (HID lighting). This includes mercury-vapor, sodium vapor and metal halide lamps.

**FEATURES**

- Switch ON/OFF
- Scene Capable
- ON/OFF LED
- Two way communication
- RF reliability
- Ease of installation – No new wiring
- Compatible with other Z-Wave™ enabled devices

**Tools needed to install your Switch**

- Slotted/Phillips Screwdriver
- Electrical Tape
- Pliers
- Pencil
- Cutters
- Ruler

**Changing the color of your Switch:**

Your switch includes three color options. The switch ships with the White frame attached. To change color of frame, proceed as follows:

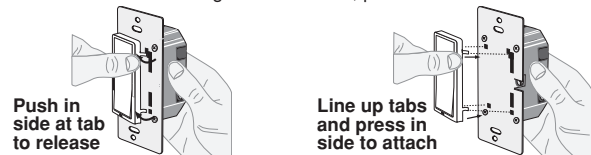

**INSTALLING YOUR SWITCH**

**NOTE:** Use check boxes  when Steps are completed.

**Step 1**

**WARNING: TO AVOID FIRE SHOCK OR DEATH; TURN OFF POWER** at circuit breaker or fuse and test that power is off before wiring!

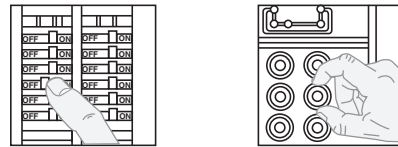

**Step 2**

**Identifying your wiring application (most common):**

**NOTE:** If the wiring in your wall box does not resemble any of these configurations, consult a qualified electrician.

**Single Pole**

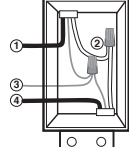

1. Line (Hot)
2. Neutral
3. Ground
4. Load

**3-Way**

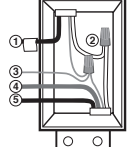

1. Line or Load (*see important instruction*)
2. Neutral
3. Ground
4. First Traveler – note color
5. Second Traveler – note color

**IMPORTANT :** For 3-Way applications, note that one of the screw terminals from the old switch being removed will usually be a different color (Black) or labeled Common. Tag that wire with electrical tape and identify as the common (Line or Load) in both the switch wall box and remote wall box.

**Step 3 Preparing and connecting wires:**

This switch can be wired using side wire terminal screws or through backwire openings. Choose appropriate wire stripping specifications accordingly.

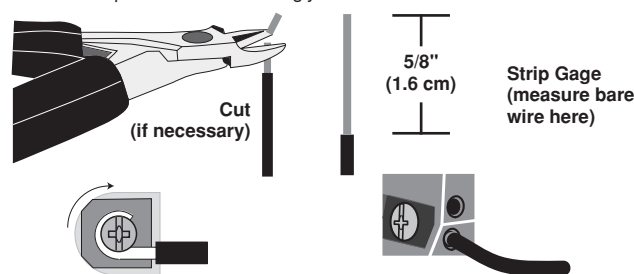

**Side Wire Connection**

Side wire terminals accept #14 AWG solid wire copper only.

- Make sure that the ends of the wires from the wall box are **straight (cut if necessary)**.
- Remove insulation from each wire in the wall box as shown.
- **For Single-Pole Application, go to Step 4a.**

**Back Wire (either hole may be used)**

Back wire openings use #14-12 AWG solid wire copper only.

- **For 3-Way Coordinating Remote (no LEDs) Application, go to Step 4b.**

**Step 4a**

**Single Pole Wiring Application:**

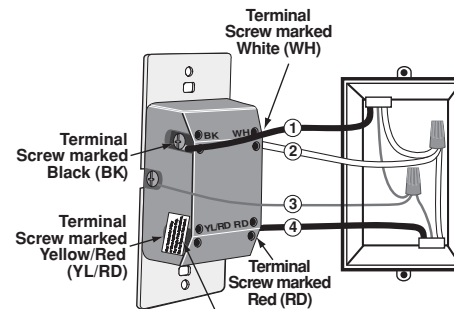

**Terminal Label:**  
Use Terminal for 3-Way or More Applications Only. For Single-Pole Applications, Do Not Remove This Label.

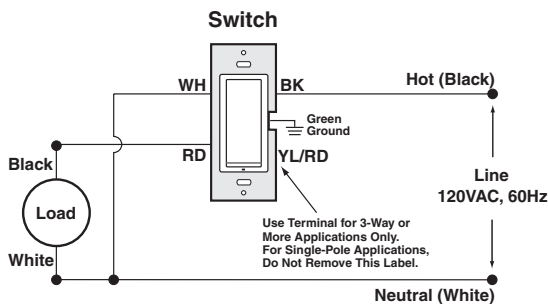

**WIRING SWITCH:**

**Connect wires per WIRING DIAGRAM as follows:**

- Green or bare copper wire in wall box to Green terminal screw.
- Line Hot wall box wire to terminal screw marked "BK".
- Load wall box wire to terminal screw marked "RD".
- Line Neutral wall box wire to terminal screw marked "WH".
- Switch terminal screw marked "YL/RD" should have Red insulation label affixed.
- **NOTE:** If insulating label is not affixed to terminal screw marked "YL/RD", use electrical tape to cover.
- **Proceed to Step 5.**

**Step 4b**

**3-Way Wiring with Coordinating Remote (no LED) Application:**

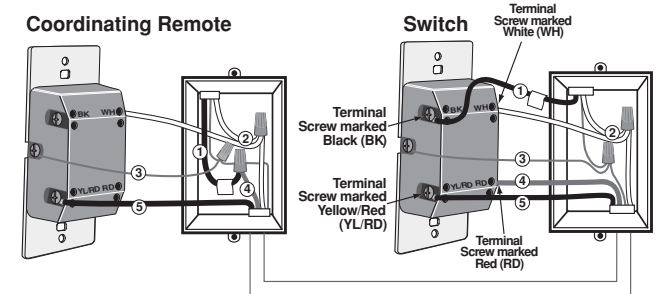

**Coordinating Remote (no LED)**

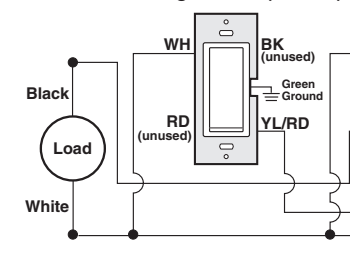

**Switch**

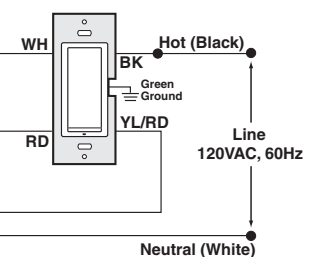

**WIRING SWITCH:**

**Connect wires per WIRING DIAGRAM as follows:**

- **NOTE:** The switch must be installed in a wall box that has a Line Hot connection.
- **NOTE:** Maximum wire length from switch to all installed remotes cannot exceed 300 ft (90 m).
- Green or bare copper wire in wall box to Green terminal screw.
- Line Hot (common) wall box wire identified (tagged) when removing old switch to terminal screw marked "BK".
- First Traveler wall box wire to terminal screw marked "RD" (**note wire color**).
- Remove Red insulating label from terminal screw marked "YL/RD".
- Second Traveler wall box wire to terminal screw marked "YL/RD" (**note wire color**). This traveler from the switch must go to the terminal screw on the remote marked "YL/RD".
- Line Neutral wall box wire to terminal screw marked "WH".

### WIRING COORDINATING REMOTE:

#### Connect wires per WIRING DIAGRAM as follows:

**NOTE:** "BK" and "RD" terminals on coordinating remote are unused. Tighten both screws.

**NOTE:** Maximum wire length from switch to last remote is 300 ft (90 m).

- Green or bare copper wire in wall box to Green terminal screw.
- Load wall box wire identified (tagged) when removing old switch to First Traveler (note color as above).
- Second Traveler wall box wire (note color as above) to terminal screw marked "YL/RD". This traveler from the remote must go to the terminal screw on the switch marked "YL/RD".
- Remove White insulating label from terminal screw marked "WH".
- Line Neutral wall box wire to terminal screw marked "WH".
- **Proceed to Step 5.**

### Step 5 Testing your Switch prior to mounting in wall box:

- Position all wires to provide room in outlet wall box for device.
- Ensure that the word "TOP" is facing up on device strap.
- Partially screw in mounting screws in wall box mounting holes.
- **NOTE:** Dress wires with a bend as shown in diagram in order to relieve stress when mounting device.

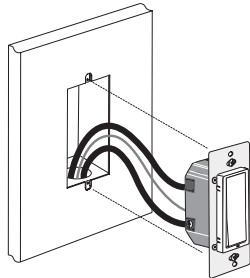

- Restore power at circuit breaker or fuse.
- Press pad until locator light is OFF. Lights should turn ON.

If lights do not turn ON, refer to the TROUBLESHOOTING section.

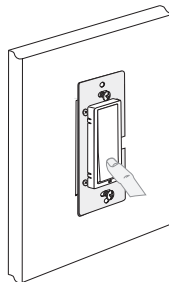

### Step 6 Including Switch into Z-Wave™ Network:



#### NOTES:

- If using a non-Leviton Programmer/Controller, refer to the Programmer/Controller instruction sheet for Including a device.
- A) If using a Leviton Z-Wave™ Programmer/Controller, Cat. No. RZCPG, press the Menu button and scroll down to System Setup. Press the center button to select System Setup Menu. Press the center button to select Network.

- B) While standing close to the switch (approximately 2-5 ft.), press the center button to <Include> device in the network.

**NOTE:** Only one device may be included at a time. **DO NOT** put multiple devices into the Inclusion mode at any time.

- C) While the Programmer/Controller is in the Inclusion mode and the Locator LED is ON on the switch, press the push pad to turn on the switch. The Programmer/Controller will verify inclusion and the Locator LED will turn OFF.

If the switch is flashing Amber while in the Inclusion mode, the Programmer/Controller is still trying to communicate with the switch. Wait until the device stops flashing, then press the push pad.

**NOTE:** If the Locator LED on the switch turns solid Red while including, there has been a communication error. Refer to Troubleshooting section.

- D) The Primary Programmer/Controller will assign a node ID number (Name) for this device.

**NOTE:** This ID number (Name) will be stored in the controller to be used for future reference.

**NOTE:** You may name or edit the node of this device at this time.

- E) **The switch is now installed in the network.**

**NOTE:** If the switch has been successfully Included in the network and the user tries to Include it again without first excluding it from the network, the switch will retain the first node ID it had received and ignore the second.

#### Programmer/Controller Cat. No. RZCPG

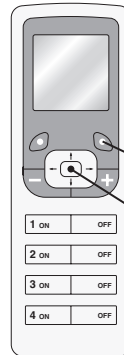

Menu Button

Center Button

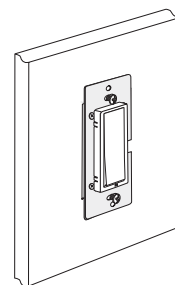

#### Programmer/Controller Cat. No. RZCPG

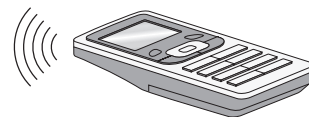

**NOTE:** Programmer/Controller must be in close proximity to switch when including in the network.

### Step 7 Excluding Switch from Z-Wave™ Network:



**NOTE:** It is very important to accurately Exclude devices from the network when moving or removing a device from a Z-Wave™ network. This ensures that all information has been removed from your Primary Programmer/Controller's information table and is not counted on to be part of the mesh network.

- A) If using a Leviton Z-Wave™ Programmer/Controller, Cat. No. RZCPG, press the Menu button and scroll down to System Setup. Press the center button to select System Setup Menu. Press the center button to select Network.

- B) While standing close to the switch (approximately 2-5 ft.), press the center button to <Exclude> device from the network.

- C) While the Programmer/Controller is in the Exclusion mode and the locator LED is ON on the Dimmer, press the push pad to turn on the switch. The Programmer/Controller will verify Exclusion and the locator LED will turn OFF.

If the switch is flashing Amber while in the Exclusion mode, the Programmer/Controller is still trying to communicate with the switch. Wait until the device stops flashing, then press the push pad.

#### Factory Default:

If your switch is not responding, or you are unable to control it after you have tried to Include/Exclude it multiple times, it may be necessary to reset the switch to its original factory settings. To accomplish this, proceed as follows:

- On the switch, engage the air-gap switch by gently pulling the bottom of the push pad until it lifts completely out of the frame and a click is heard. (refer to figure). Wait 5 seconds and then press the push pad back into the frame and hold push pad until the locator LED flashes Amber and turns solid Red. The switch is now reset. Once the switch is reset, it will be necessary to Re-Include it to a network before it can be used.

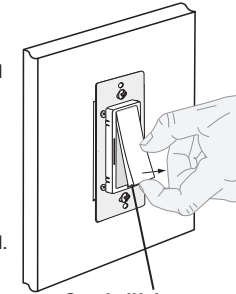

Gently lift bottom of push pad out

**CAUTION:** SETTING A DEVICE TO A FACTORY DEFAULT DOES NOT EXCLUDE THAT DEVICE FROM A NETWORK. THE EXCLUSION PROCEDURE MUST STILL BE FOLLOWED TO REMOVE THE DEVICE FROM THE PRIMARY CONTROLLER'S INFORMATION TABLE. FAILURE TO DO SO MAY RESULT IN SYSTEM THAT IS SLOW TO RESPOND, OR MAY FAIL TO RESPOND TO SOME DEVICES.

### Step 8 Switch Mounting:



TURN OFF POWER AT CIRCUIT BREAKER OR FUSE.

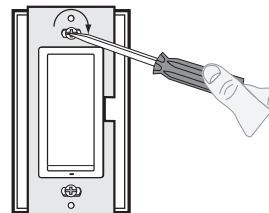

Installation may now be completed by tightening mounting screws into wall box. Attach wallplate.

### Step 9 Restore Power:



Restore power at circuit breaker or fuse. Installation is complete.

### OPERATION

**NOTE:** The locator light will illuminate when the load is in the OFF position to facilitate access in the dark.

#### Push Pad (Default settings)

**Turn ON from OFF position:**

Tap – Lights turn ON.

**Turn OFF from ON position:**

Tap – Lights turn OFF.

If there is a power outage, when the power is restored, the lights will return to the last setting before the power interruption.

**Cleaning:** Clean with a damp cloth. **DO NOT** use chemical cleaners.

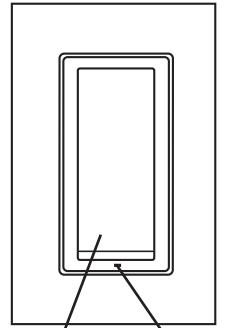

Push Pad  
Locator Light

### TROUBLESHOOTING

#### Lights Flickering

- Lamp has a bad connection.
- Wires not secured firmly under terminal screws of switch and/or remote.

#### Light does not turn ON and Locator LED does not turn ON

- Circuit breaker or fuse has tripped.
- Lamp is burned out.
- Lamp Neutral connection is not wired.

#### Remote does not operate lights

- Ensure that total wire length does not exceed 300 ft (90 m).

For additional information, contact Leviton's Techline at 1-800-824-3005 or visit Leviton's website at [www.ViziaRF.com](http://www.ViziaRF.com)

U.S. & Foreign Patents Pending  
Copyright© 2006 Leviton Manufacturing Co., Inc.  
All Rights Including Trade Dress Rights Reserved

### FCC COMPLIANCE STATEMENT

This equipment has been tested and found to comply with the limits for a Class B Digital Device, pursuant to Part 15 of the FCC Rules. These limits are designed to provide reasonable protection against harmful interference in a residential installation. This equipment generates, uses, and can radiate radio frequency energy and, if not installed and used in accordance with the instructions, may cause harmful interference to radio communications. However, there is no guarantee that interference will not occur in a particular installation. If this equipment does cause harmful interference to radio or television reception, which can be determined by turning the equipment OFF and ON, the user is encouraged to try to correct the interference by one or more of the following measures:

- Reorient or relocate the receiving Antenna.
- Increase the separation between the equipment and the receiver.
- Connect the equipment into an outlet on a circuit different from that to which the receiver is connected.
- Consult the dealer or an experienced radio/tv technician for help.

DI-000-RZS15-00A-X3

### LIMITED 5 YEAR WARRANTY AND EXCLUSIONS

Leviton warrants to the original consumer purchaser and not for the benefit of anyone else that this product at the time of its sale by Leviton is free of defects in materials and workmanship under normal and proper use for five years from the purchase date. Leviton's only obligation is to correct such defects by repair or replacement, at its option, if within such five year period the product is returned prepaid, with proof of purchase date, and a description of the problem to Leviton Manufacturing Co., Inc., Attn: Quality Assurance Department, 59-25 Little Neck Parkway, Little Neck, New York 11362-2591. This warranty excludes and there is disclaimed liability for labor for removal of this product or reinstallation. This warranty is void if this product is installed improperly or in an improper environment, overloaded, misused, opened, abused, or altered in any manner, or is not used under normal operating conditions or not in accordance with any labels or instructions. **There are no other or implied warranties of any kind, including merchantability and fitness for a particular purpose, but if any implied warranty is required by the applicable jurisdiction, the duration of any such implied warranty, including merchantability and fitness for a particular purpose, is limited to five years. Leviton is not liable for incidental, indirect, special, or consequential damages, including without limitation, damage to, or loss of use of, any equipment, lost sales or profits or delay or failure to perform this warranty obligation.** The remedies provided herein are the exclusive remedies under this warranty, whether based on contract, tort or otherwise.

## Free Manuals Download Website

<http://myh66.com>

<http://usermanuals.us>

<http://www.somanuals.com>

<http://www.4manuals.cc>

<http://www.manual-lib.com>

<http://www.404manual.com>

<http://www.luxmanual.com>

<http://aubethermostatmanual.com>

Golf course search by state

<http://golfingnear.com>

Email search by domain

<http://emailbydomain.com>

Auto manuals search

<http://auto.somanuals.com>

TV manuals search

<http://tv.somanuals.com>