

lexicon[®]

Owner's Manual



LAMBDA[™]
DESKTOP RECORDING STUDIO



COMPLETE RECORDING SOLUTION

Download from www.Somanuals.com. All Manuals Search And Download.

IMPORTANT SAFETY INSTRUCTIONS



CAUTION

RISK OF ELECTRIC SHOCK
DO NOT OPEN



ATTENTION: RISQUE DE CHOC ELECTRIQUE - NE PAS OUVRIR

WARNING: TO REDUCE THE RISK OF FIRE OR ELECTRIC SHOCK DO NOT EXPOSE THIS EQUIPMENT TO RAIN OR MOISTURE

The symbols shown above are internationally accepted symbols that warn of potential hazards with electrical products. The lightning flash with arrowpoint in an equilateral triangle means that there are dangerous voltages present within the unit. The exclamation point in an equilateral triangle indicates that it is necessary for the user to refer to the owner's manual.

These symbols warn that there are no user serviceable parts inside the unit. Do not open the unit. Do not attempt to service the unit yourself. Refer all servicing to qualified personnel. Opening the chassis for any reason will void the manufacturer's warranty. Do not get the unit wet. If liquid is spilled on the unit, shut it off immediately and take it to a dealer for service. Disconnect the unit during storms to prevent damage.

SAFETY INSTRUCTIONS

NOTICE FOR CUSTOMERS IF YOUR UNIT IS EQUIPPED WITH A POWER CORD.

WARNING: THIS APPLIANCE MUST BE EARTHED. CONNECT ONLY TO A MAINS SOCKET OUTLET WITH PROTECTIVE EARTHING CONNECTION.

The cores in the mains lead are coloured in accordance with the following code:

GREEN and YELLOW - Earth BLUE - Neutral BROWN - Live

As colours of the cores in the mains lead of this appliance may not correspond with the coloured markings identifying the terminals in your plug, proceed as follows:

- The core which is coloured green and yellow must be connected to the terminal in the plug marked with the letter E, or with the earth symbol, or coloured green, or green and yellow.
- The core which is coloured blue must be connected to the terminal marked N or coloured black.
- The core which is coloured brown must be connected to the terminal marked L or coloured red.

This equipment may require the use of a different line cord, attachment plug, or both, depending on the available power source at installation. If the attachment plug needs to be changed, refer servicing to qualified service personnel who should refer to the table below. The green/yellow wire shall be connected directly to the units chassis.

| CONDUCTOR | WIRE COLOR | |
|-------------|------------|-------|
| | Normal | Alt |
| L LIVE | BROWN | BLACK |
| N NEUTRAL | BLUE | WHITE |
| E EARTH GND | GREEN/YEL | GREEN |

WARNING: If the ground is defeated, certain fault conditions in the unit or in the system to which it is connected can result in full line voltage between chassis and earth ground. Severe injury or death can then result if the chassis and earth ground are touched simultaneously.

WARNING FOR YOUR PROTECTION

READ THESE INSTRUCTIONS:

KEEP THESE INSTRUCTIONS

HEED ALL WARNINGS

FOLLOW ALL INSTRUCTIONS

DO NOT USE THIS APPARATUS NEAR WATER

THE APPARATUS SHALL NOT BE EXPOSED TO DRIPPING OR SPLASHING LIQUID AND NO OBJECT FILLED WITH LIQUID, SUCH AS VASES, SHALL BE PLACED ON THE APPARATUS.

CLEAN ONLY WITH A DRY CLOTH.

DO NOT BLOCK ANY OF THE VENTILATION OPENINGS. INSTALL IN ACCORDANCE WITH THE MANUFACTURER'S INSTRUCTIONS.

DO NOT INSTALL NEAR ANY HEAT SOURCES SUCH AS RADIATORS, HEAT REGISTERS, STOVES, OR OTHER APPARATUS (INCLUDING AMPLIFIERS) THAT PRODUCE HEAT.

ONLY USE ATTACHMENTS/ACCESSORIES SPECIFIED BY THE MANUFACTURER.

UNPLUG THIS APPARATUS DURING LIGHTNING STORMS OR WHEN UNUSED FOR LONG PERIODS OF TIME.

Do not defeat the safety purpose of the polarized or grounding-type plug. A polarized plug has two blades with one wider than the other. A grounding type plug has two blades and a third grounding prong. The wide blade or third prong are provided for your safety. If the provided plug does not fit your outlet, consult an electrician for replacement of the obsolete outlet.

Protect the power cord from being walked on or pinched particularly at plugs, convenience receptacles, and the point where they exit from the apparatus.

Use only with the cart stand, tripod bracket, or table specified by the manufacturer, or sold with the apparatus. When a cart is used, use caution when moving the cart/apparatus combination to avoid injury from tip-over.



Refer all servicing to qualified service personnel. Servicing is required when the apparatus has been damaged in any way, such as power-supply cord or plug is damaged, liquid has been spilled or objects have fallen into the apparatus, the apparatus has been exposed to rain or moisture, does not operate normally, or has been dropped.

POWER ON/OFF SWITCH: For products provided with a power switch, the power switch DOES NOT break the connection from the mains.

MAINS DISCONNECT: The plug shall remain readily operable. For rack-mount or installation where plug is not accessible, an all-pole mains switch with a contact separation of at least 3 mm in each pole shall be incorporated into the electrical installation of the rack or building.

FOR UNITS EQUIPPED WITH EXTERNALLY ACCESSIBLE FUSE RECEPTACLE: Replace fuse with same type and rating only.

MULTIPLE-INPUT VOLTAGE: This equipment may require the use of a different line cord, attachment plug, or both, depending on the available power source at installation. Connect this equipment only to the power source indicated on the equipment rear panel. To reduce the risk of fire or electric shock, refer servicing to qualified service personnel or equivalent.

This Equipment is intended for rack mount use only.

IMPORTANT SAFETY INSTRUCTIONS

ELECTROMAGNETIC COMPATIBILITY

This unit conforms to the Product Specifications noted on the **Declaration of Conformity**. Operation is subject to the following two conditions:

- this device may not cause harmful interference, and
- this device must accept any interference received, including interference that may cause undesired operation.

Operation of this unit within significant electromagnetic fields should be avoided.

- use only shielded interconnecting cables.

U.K. MAINS PLUG WARNING

A molded mains plug that has been cut off from the cord is unsafe. Discard the mains plug at a suitable disposal facility.

NEVER UNDER ANY CIRCUMSTANCES SHOULD YOU INSERT A DAMAGED OR CUT MAINS PLUG INTO A 13 AMP POWER SOCKET.

Do not use the mains plug without the fuse cover in place. Replacement fuse covers can be obtained from your local retailer.

Replacement fuses are 13 amps and MUST be ASTA approved to BS1362.

DECLARATION OF CONFORMITY

Manufacturer's Name: Lexicon Professional
Manufacturer's Address: 8760 S. Sandy Pkwy.
Sandy, UT 84070, USA

Declares that the product:

Product name: Lexicon Lambda™
Note: Product name may be suffixed by the letters-EU.

Product option: all (requires Class II power adapter that conforms to the requirements of EN60065, EN60742, or equivalent.)

Conforms to the following Product Specifications:

Safety: IEC 60065 (2002)

EMC: EN 55013 (2001 + A1)
EN 55020 (1998)

Supplementary Information:

The product herewith complies with the requirements of the Low Voltage Directive 72/23/EEC and the EMC Directive 89/336/EEC as amended by Directive 93/68/EEC.

Vice-President
of Engineering

8760 S. Sandy Parkway
Sandy, Utah 84070, USA
Date: October 24, 2005

European Contact: Your local Lexicon
Professional Sales
and Service Office or

Harman Music Group
8760 S. Sandy Pkwy.
Sandy, UT 84070 USA
Ph: (801) 566-8800
Fax: (801) 568-7583

SERVICE INFO

If you require technical support, contact Lexicon® Professional Customer Service. Be prepared to accurately describe the problem. Know the serial number of your unit, found on a sticker attached to the bottom of the Lambda Studio™. If you have not already taken the time to fill out your warranty registration card and send it in, please do so now.

Before you return a product to the factory for service, we recommend you refer to the manual. Make sure you have correctly followed installation steps and operation procedures. If you are still unable to solve a problem, contact our Customer Service Department at **(801) 568-7660** for consultation. If you need to return a product to the factory for service, you **MUST** contact Customer Service to obtain a Return Authorization Number. No returned products will be accepted at the factory without a Return Authorization Number. Please refer to the Warranty information on the following page, which extends to the first end-user. After expiration of the warranty, a reasonable charge will be made for parts, labor, and packing if you choose to use the factory service facility. In all cases, you are responsible for transportation charges to the factory. Lexicon Professional will pay return shipping if the unit is still under warranty.

Use the original packing material if it is available. Mark the package with the name of the shipper and with these words in red: **DELICATE INSTRUMENT, FRAGILE!** Insure the package properly. Ship prepaid, not collect. Do not ship parcel post.

WARRANTY

This warranty is valid only for the original purchaser and only in the United States.

1. The warranty registration card that accompanies this product must be mailed (or online registration must be completed at www.lexiconpro.com) within 30 days after purchase date to validate this warranty. Proof-of-purchase is considered to be the burden of the consumer.
2. Lexicon Professional warrants this product, when bought and used solely within the U.S., to be free from defects in materials and workmanship under normal use and service.
3. Lexicon Professional's liability under this warranty is limited to repairing or, at our discretion, replacing defective materials that show evidence of defect, provided the product is returned to Lexicon Professional **WITH RETURN AUTHORIZATION** from the factory, where all parts and labor will be covered up to a period of 1 year. A Return Authorization number must be obtained from Lexicon Professional by telephone. The company shall not be liable for any consequential damage as a result of the product's use in any circuit or assembly.
4. Lexicon Professional reserves the right to make changes in design or make additions to or improvements upon this product without incurring any obligation to install the same additions or improvements on products previously manufactured.
5. The foregoing is in lieu of all other warranties, expressed or implied, and Lexicon Professional neither assumes nor authorizes any person to assume on its behalf any obligation or liability in connection with the sale of this product. In no event shall Lexicon Professional or its dealers be liable for special or consequential damages or from any delay in the performance of this warranty due to causes beyond its control.

TABLE OF CONTENTS

| | |
|--|-----------|
| INTRODUCTION | 8 |
| FEATURES | 8 |
| UNPACKING THE LAMBDA STUDIO™ | 9 |
| COMPUTER MINIMUM REQUIREMENTS | 9 |
| Windows® | 9 |
| Macintosh® | 9 |
| THE FRONT PANEL | 10 |
| Mic 1-2 Gain..... | 10 |
| Line 1-2 Gain..... | 10 |
| Peak LEDs..... | 10 |
| Monitor Assign..... | 10 |
| Monitor Mix Control..... | 11 |
| Output Level..... | 11 |
| Input Bargraph Meter..... | 11 |
| USB LED..... | 11 |
| +48V Phantom Power LED..... | 11 |
| 1/8" Headphone Output Jack..... | 11 |
| 1/4" Instrument Input Jack..... | 11 |
| THE REAR PANEL | 12 |
| Line In 1-2..... | 12 |
| Insert 1-2 | 12 |
| Mic 1-2 Inputs | 12 |
| Left/Right Line Outputs..... | 12 |
| MIDI In and Out | 12 |
| +48V Phantom Power Switch..... | 13 |
| USB Port | 13 |
| CONNECTING TO THE LAMBDA STUDIO | 13 |
| MONITORING CONNECTIONS..... | 13 |
| Connecting Headphones..... | 13 |
| Connecting to Monitor Speakers..... | 13 |
| Connecting to a Home Stereo | 14 |
| ABOUT RECORDING CONNECTIONS | 14 |
| To Connect a Microphone..... | 14 |
| To Activate Phantom Power..... | 14 |
| Using the Analog Inserts..... | 14 |
| To Connect a Line Level Source..... | 15 |
| To Connect an Instrument..... | 15 |

| | |
|---|-----------|
| MIXDOWN CONNECTIONS | 15 |
| Connecting to an External Recorder | 15 |
| Mixing Within Cubase® LE | 16 |
| WINDOWS® SOFTWARE SETUP | 16 |
| Windows® XP | 16 |
| MACINTOSH® SOFTWARE SETUP | 17 |
| Mac OS | 17 |
| USING THE LEXICON® LAMBDA STUDIO™ ... | 18 |
| Section I – Recording audio With the Lambda Studio™ | 19 |
| A. Recording using the Microphone/line Input..... | 19 |
| B. Recording a Guitar using the Instrument input..... | 26 |
| Section II – Recording MIDI with the Lambda Studio | 28 |
| Section III – Using software Input Monitoring | 29 |
| Section IV – Adjusting the Buffer Settings | 32 |
| A. Adjusting the Buffers in Windows® XP | 32 |
| B. Adjusting the Buffers in Mac OSX..... | 33 |
| SPECIFICATIONS | 34 |
| SIGNAL ROUTING DIAGRAM | 35 |

INTRODUCTION

Congratulations on your purchase of the Lexicon® Lambda Desktop Recording Studio™. The Lexicon Lambda Studio is a complete package of hardware and software that turns your USB-equipped computer into a professional multitrack recording workstation. Whether you use it for high-quality stereo location recording with a laptop computer, or for multitrack overdubbing and mixing in a home studio desktop system with MIDI synthesizers, the Lambda Studio hardware provides the professional-quality inputs and outputs, metering, and level controls that computer sound cards or built-in audio connections lack.

So you can make full use of the Lambda Studio right away, we've included the popular Steinberg® Cubase® LE production suite software for PC and Mac computers. Cubase LE offers integrated multi-track recording, editing and mixing of up to 48 audio tracks, 64 MIDI tracks, VST® Instruments support, VST plug-in effects support, and an array of additional features. Lexicon's Pantheon™ VST reverb plug-in is a major feature of the Lambda Studio package, providing the lush Lexicon reverbs that have been used on professional recordings for over thirty years. Alternatively, the Lexicon Lambda Studio may be used as an interface with almost any other major audio recording software you may have, such as Steinberg Nuendo®, Cubase SX®, MOTU® Digital Performer®, Garage Band®, Cakewalk® Sonar™, and many others.

FEATURES

THE LAMBDA DESKTOP RECORDING STUDIO™
PROVIDES THE FOLLOWING:

- 5 analog audio inputs
- 2 - XLR mic inputs with extremely low noise dbx® preamps, 50 dB gain, and +48V phantom power (**switchable**)
- ¼" TRS Insert jack on each mic input
- 2 - ¼" analog RF filtered TRS active-balanced line inputs
- 1 - ¼" ultra-high-impedance analog instrument input
- 2 - ¼" analog TRS servo-balanced, active line outputs
- High powered headphone amplifier
- MIDI In and Out
- 24-bit A/D and D/A converters, supporting sample rates of 44.1 kHz and 48 kHz
- Zero-latency analog record monitoring with adjustable balance between Direct and Playback
- Stereo and Mono input source monitoring
- 100% USB Powered

UNPACKING THE LAMBDA STUDIO™

The Lambda Studio™ is shipped in one carton, containing the Lambda Studio Interface hardware, Steinberg® Cubase® LE and Lexicon® Pantheon™ plug-in software for Windows® and Macintosh® based systems. After unpacking, save all the packaging materials in case you ever have to ship the unit. Thoroughly inspect the Lambda Studio and packing materials for signs of damage. Report any shipment damage to the carrier that delivered the product or dealer from whom you purchased the product at once.

THE FOLLOWING ITEMS ARE INCLUDED:

- Lambda desktop audio interface hardware
- Installer CD-ROM containing Cubase LE Recording Software, USB drivers and the Lexicon Pantheon Reverb Plug-in for Mac and Windows
- USB Connector Cable
- This Owner's Manual
- Lexicon Pantheon™ Reverb Plug-in User's Guide
- Lambda Studio Software Installation Guide
- Lexicon Professional warranty registration

NOTE: The full Cubase LE manual is located “online” on the software CD

COMPUTER MINIMUM REQUIREMENTS

Powerful software for audio recording requires a powerful computer with the right operating system software, processor, memory, and hard drive space. Most computers currently sold already meet these requirements, or can be upgraded to be compatible with the Lexicon Lambda Desktop Recording Studio. As with all such systems, adding more RAM than the minimum will allow you to do more processing and improve performance, and more disk space will allow you to record more tracks for a longer time. See the Lambda Studio Software Installation Guide and the Cubase LE manual for more information.

WINDOWS®

- Pentium® III 500 MHz or AMD K7 processor, or better
(Pentium 4/Athlon 1 GHz or faster recommended)
- Windows XP Home or XP Professional
- 256 MB RAM **(512 MB recommended)**
- 1 GB of available hard disk space
- 7200RPM hard disk type or better

MACINTOSH®

- Power PC®, G4 Processor **(450 MHz or faster)**
- Mac OS X version 10.2.8 or higher
- 256 MB RAM minimum **(512MB recommended)**
- 1 GB available hard disk space
- 7200RPM hard disk type or better

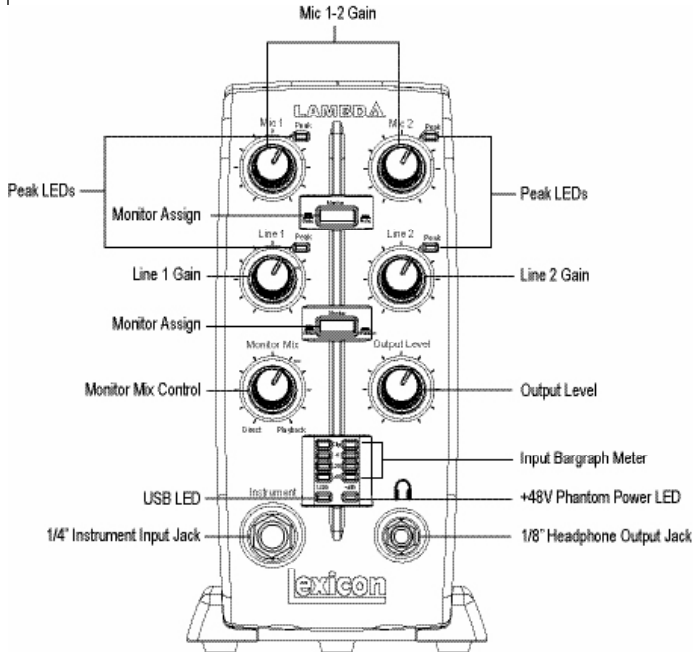

For the cleanest recording, adjust the Gain so the level reaches at least -6 on the Input Bargraph Meter, but never lights the Clip LED on the loudest sound you'll be recording. If you see the Peak LED light constantly, turn the Gain knob down until it flashes only occasionally, on the loudest part of the performance.

DO NOT TURN DOWN A GAIN CONTROL TO GET THE RIGHT MIX IN YOUR HEADPHONES OR MONITORS WHILE RECORDING. USE THE **Monitor Mix CONTROL** FOR THIS PURPOSE.

THE FRONT PANEL

The Lambda Studio™ front panel offers the following features:

MIC 1-2 GAIN

These knobs adjust the input gain levels of the Mic 1 and Mic 2 inputs.

LINE 1-2 GAIN

These knobs adjust the input gain levels of the Line 1 and Line 2 inputs.

PEAK LEDS

These LEDs light when the input signal is within 5dB of analog clipping. If the Peak LEDs flicker occasionally, the signal is approaching clipping levels, but does not necessarily indicate distortion or actual clipping.

MONITOR ASSIGN

These buttons select whether a pair of analog audio sources will be heard in stereo in the Direct Monitor Mix. In Stereo mode, the left inputs (**Mic 1, Line 1**) are routed to the left monitor and right (**Mic 2, Line 2**) inputs are routed to the right monitor.

In Mono mode, you'll hear the selected inputs in the center of the Direct Monitor Mix through the Headphone or Line outputs.

When a Monitor switch is in Mono, it does not change the signals going to the computer in any way—they will still be separate and stereo in the computer.

MONITOR MIX CONTROL

The Lambda Studio™ gives you the ability to hear your analog input signals directly and immediately while recording, without having to adjust levels in software, and before the delay caused by digital converters and computer recording latency. This zero-latency analog monitoring is controlled by the **Monitor Mix** knob, which you can use to adjust the blend between the Lambda Studio's live analog inputs (called "**Direct**") and any sounds coming back from the computer via USB ("**Playback**"). To adjust the playback mix coming back from the computer (**previous tracks, effect returns etc.**), use the faders on the Mixer screen of the software. To hear only the live source input signals plugged into the Lambda Studio, turn the **Monitor Mix** knob fully left to **Direct**. To hear only the mix from the computer, turn the **Monitor Mix** knob fully right to **Playback**. The output from the Monitor Mix control is routed directly to the Line and Headphone outputs. This ability to easily control the relative levels of computer audio playback and latency-free live analog inputs is very useful when overdubbing.

OUTPUT LEVEL

This knob controls the overall output level of the Lambda Studio's Line and Headphone outputs.

INPUT BARGRAPH METER

This LED Meter shows the signal level going into the A/D converters. When the Input Bargraph Meter's Clip LEDs illuminate, input signals are clipping the A/D converter. Adjust the gain with the **Mic** and **Line** knobs so that the -6 dB LED flashes only occasionally.

USB LED

When the blue **USB** LED is on, it shows the Lambda Studio is powered and communicating with your computer via USB, and audio and MIDI signals can pass in and out of the system.

+48V PHANTOM POWER LED

This LED indicates that 48 volt phantom power is active on the Mic 1 and Mic 2 inputs, providing phantom power for condenser microphones that require it to operate. Turn phantom power on or off as needed with the switch labeled **+48V** on the rear panel.

1/8" HEADPHONE OUTPUT JACK

The high powered Headphone output accommodates stereo headphones with an 1/8" stereo plug.

" INSTRUMENT INPUT JACK

This 1/4" jack accepts unbalanced, low-level, high impedance instrument sources such as electric guitar, acoustic guitar with a pickup, and electric bass. The input gain is adjusted using the Line 1 knob on the front panel. When an instrument is plugged into this input, it disables the **Line 1** audio input on the rear panel.

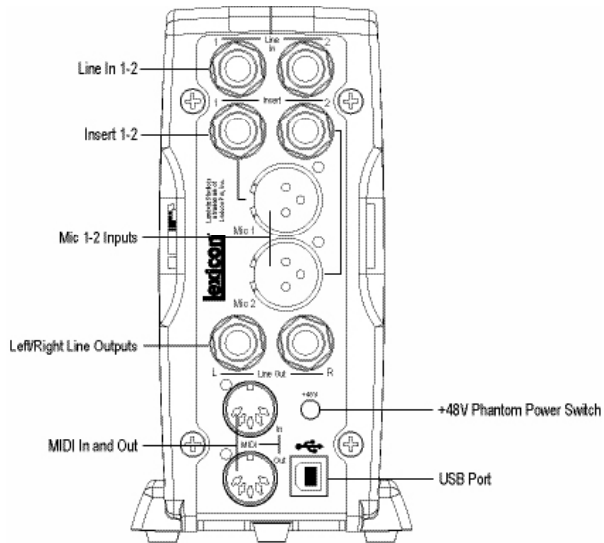

THE REAR PANEL

The Lambda Studio™ rear panel offers the following features:

LINE IN 1-2

These ¼" inputs can accept both balanced (**3-conductor TRS**) and unbalanced (**2-conductor TS or instrument**) audio sources. Each input gain is adjusted individually using the **Line 1-2** gain knobs on the front panel.

INSERT 1-2

Each mic input is equipped with a TRS insert point. Inserts provide a send and return of the input channel's signal directly after the mic preamp and before the A/D converter. You can insert any line level signal processor (**such as a compressor or equalizer**) to pre-process the mic signal before it is recorded, using a standard "stereo splitter" (**single TRS to two TS**) cable. The tip is send and the ring is return.

MIC 1-2 INPUTS

These balanced XLR inputs feature high-quality mic preamps designed specifically for low-impedance professional microphones. The input gain is adjusted using the **Mic 1-2** gain knobs on the front panel respectively, with 50 dB of gain at the maximum setting.

LEFT/RIGHT LINE OUTPUTS

These outputs support balanced TRS or unbalanced TS ¼" connections. These outputs can be connected to a mixing board, power amplifier, powered studio monitors, recorder, or another line level input.

MIDI IN AND OUT

The MIDI jacks provide MIDI input and MIDI output to and from your computer. Connect your MIDI keyboards, sound modules, and external controllers here.

IMPORTANT:

Do not plug a line output into the **Mic In** jacks unless the +48 V (phantom) switch is turned OFF to avoid damage.

+48V PHANTOM POWER SWITCH

This enables the phantom power to the Mic 1 and Mic 2 inputs. Dynamic microphones do not require phantom power to operate, but are not harmed by it. Most condenser microphones do require phantom power to operate. If you are unsure about the phantom power requirements for your microphone, consult your microphone's documentation or contact the manufacturer. This switch should be OFF if you are connecting any line-level source to the Mic In jacks.

IMPORTANT:

Do not plug a line output into the Mic In jacks unless the +48 V (phantom) switch is turned OFF to avoid damage.

USB PORT

The USB Port is used to connect the Lambda Studio™ to your computer and provides the Lambda Studio hardware with power. A standard USB cable is included. The Lambda Studio supports USB 2.0 full speed.

CONNECTING TO THE LAMBDA STUDIO™

The Lambda Studio is both a 4 x 2 x 2 mixer and a USB audio/MIDI interface that can be used in a variety of audio setups. This section describes how to make basic connections for the following applications:

- Monitoring Audio
- Recording Audio
- Connecting a Recorder for Mixdown

MONITORING CONNECTIONS

The Lambda Studio allows you to monitor audio both from the hardware inputs (**Direct**) and from the computer (**Playback**). Use the **Monitor Mix** control to balance between the direct audio and playback audio from your computer (**For a complete description of the Monitor Mix control, see page 11**).

You can listen to (**or monitor**) the audio through either the 1/8" Headphone jack on the front panel, or through studio monitors using the 1/4" L/R Line Out jacks on the rear panel, or both. The output level of both the L/R Line Out jacks and the Headphone jack are controlled with the Output Level knob above the Headphone jack on the front panel.

Lambda Studio's L/R Line Outputs have a nominal output of +4dBu, and support both balanced (" **TRS**) or unbalanced (" **TS**) connections.

CONNECTING HEADPHONES:

1. Connect headphones to the Headphone jack located on the front panel of the Lambda Studio. The Headphone jack accepts an 1/8" TRS connector.
2. Adjust headphone volume with the **Output Level** knob.

CONNECTING TO MONITOR SPEAKERS:

1. Using 1/4" cables, connect the L/R Line Out jacks on the rear panel of the Lambda Studio to the appropriate inputs on your mixer, power amp, or powered monitors.
2. Adjust the Lambda Studio's output volume with the **Output Level** knob. If using

both headphones and monitor speakers, adjust the level of the external power amp or speakers using their gain controls after you've set the desired level in your headphones.

CONNECTING TO A HOME STEREO

Connect the **Line Out 1-2** jacks on the rear panel of the Lambda Studio™ to the appropriate inputs on your stereo, typically the Tape In or Aux In jacks, using a ¼" to male phono (**RCA**) connector or adapter. Keep the **Output Level** knob on the Lambda Studio low at first, raising it slowly to match the level of other units connected to the stereo.

ABOUT RECORDING CONNECTIONS

Analog audio signals are created by microphones, synthesizers, mixers, and instruments with magnetic pickups.

Of these sources, microphones and magnetic instrument pickups have the lowest output level, and generally require the most amplification. Keyboards, preamps, and mixers output "line level" audio, which varies with each device between the -10 dBV and +4 dBu standards.

TO CONNECT A MICROPHONE

Plug an XLR cable directly from a microphone into the desired **Mic** input on the Lambda Studio rear panel.

IMPORTANT!

Do not plug a line output into the Mic 1-2 jacks unless the +48 V (**phantom**) switch is turned OFF to avoid damage.

TO ACTIVATE PHANTOM POWER

If your microphone requires phantom power, first make sure the microphone is connected, then press the Phantom Power switch (**labeled +48V**). The +48V Phantom Power LED on the front panel indicates the phantom power is active. If your mics don't need phantom power, it is best to leave it off.

USING THE ANALOG INSERTS

The analog inserts require a ¼" TRS to 2 x ¼" TS adapter cable. The signal from the tip should be routed to the input of your outboard processor and the output of your processor should be routed to the ring.

External FX Processor

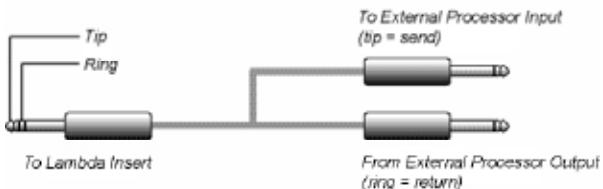

TO CONNECT A LINE LEVEL SOURCE

Plug a ¼" TS (**unbalanced**) or TRS (**balanced**) cable directly from the line level source into the desired **Line In** jack on the rear panel of Lambda Studio. Line level sources include keyboards, drum machines, CD and cassette players, or external microphone preamps and effects. If the line level source has something other than ¼" outputs, cable adapters can be used.

TO CONNECT AN INSTRUMENT

Plug a standard ¼" TS (**instrument**) cable directly from the instrument into the **Instrument** input jack on the front panel of Lambda Studio. Note that this will disable the Line In 1 jack on the back panel.

MIXDOWN CONNECTIONS

After you record and mix your sessions in either Cubase® LE or other recording software, you may want to mix them down to a DAT, audio cassette, or other stereo 2-track recording device.

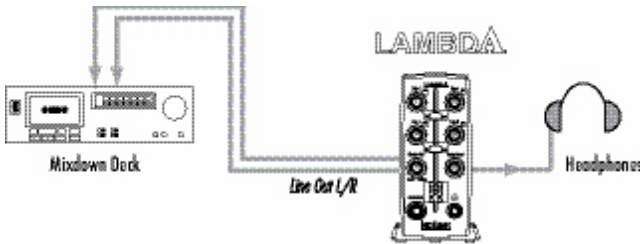

CONNECTING TO AN EXTERNAL RECORDER

Connect the **Line Out L-R** jacks on the back of the Lambda Studio™ to the left and right inputs, respectively, on your recorder (**cassette deck, CD burner, or other recorder with analog inputs**). You may need adapter cables if your mixdown deck has RCA input jacks. Refer to your recorder's operator's manual for more information about setting recording levels.

If you are connecting to an analog mixdown deck (**such as a cassette recorder**), start with the **Output Level** knob on the Lambda Studio at about the 12 o'clock (**straight up**) position, and the recorder's input level also at or near 12 o'clock. Adjust the **Output Level** knob on the Lambda Studio until the meters on your recording deck (**NOT the Lambda Studio**) read consistently between 0dB to +4dB, raising the input level control on the recorder if necessary.

If you are connecting to a digital recorder such as a DAT or CD recorder, set the input level(s) on the recording device all the way open, to their maximum setting, and then adjust the **Output Level** knob on the Lambda Studio until the meters on your recording deck device consistently peak just below the 0dBFS (**Full Scale**) mark without causing clipping (**going over the 0dBFS mark**).

To hear the mix through control room speakers, connect the outputs of the recorder to the inputs of the control room amplifier or powered monitors. Adjust the control room

For the cleanest recording, adjust the Gain so the level reaches at least -6 on the input bargraph meter, but never lights the "Clip" LED on the loudest sound you'll be recording. If you see the Peak LED light constantly, turn the Gain knob down until it flashes only occasionally, on the loudest part of the performance.

DO NOT TURN DOWN A GAIN CONTROL TO GET THE RIGHT MIX IN YOUR HEADPHONES OR MONITORS WHILE RECORDING. USE THE MONITOR MIX CONTROL FOR THIS PURPOSE.

level using the output level of the recording deck or the input level of the control room amplifier or speakers.

MIXING WITHIN CUBASE® LE

You can mixdown directly within Cubase LE or other recording software, and burn an audio CD from that mix (**provided your computer has a CD-R drive**). Consult the Cubase LE online manual or documentation for your recording software for a complete description of mixing within the software.

CONNECTIONS DIAGRAM

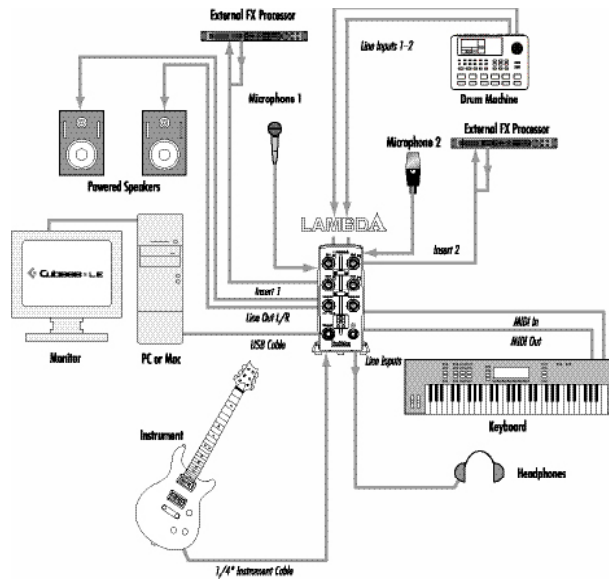

WINDOWS® SOFTWARE SETUP

You **must** consult the Software Installation Guide packaged inside the Lambda Studio™ box to ensure the successful installation of the recording software and USB drivers.

If you haven't already installed the Cubase LE and Lexicon® Pantheon™ plug-in software, please do so before continuing on to the next section. Follow the on-screen instructions to install the USB drivers.

WINDOWS® XP

You must install the USB drivers after you've made the connection between your computer's USB port and the USB port of the Lambda Studio™.

MACINTOSH® SOFTWARE SETUP

You **must** consult the Software Installation Guide packaged inside the Lambda Studio box to ensure the successful installation of the recording software and USB setup.

If you haven't already installed the Cubase® LE and Lexicon Pantheon™ plug-in software, please do so before continuing on to the next section.

MAC OS

A USB device must initialize itself with the host computer to operate correctly. The Lambda Studio comprises multiple devices (**audio and MIDI**) and each of those must be initialized. Some Apple® Macintosh® computers will not recognize all of these devices if the Lambda Studio is connected to the USB port before the computer is turned on. The simplest way to avoid problems is to connect the Lambda Studio to the USB port after the computer is booted.

USING THE LEXICON® LAMBDA STUDIO™

1. Start Cubase® LE. The first time you use Cubase LE with the Lambda Studio™ you may be asked to run the Multimedia test as shown here. Deselect the check box, then click **NO**.

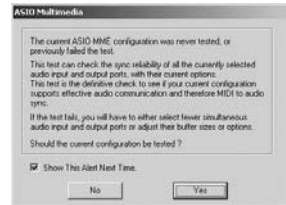

2. Cubase LE will display the following warning that the configuration has not been tested. Click **OK**.



3. Once Cubase LE opens, go to **Devices>Device Setup**.

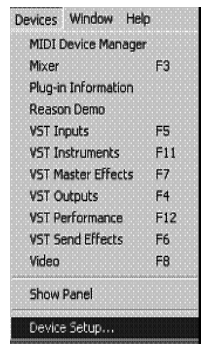

4. Under **Devices**, click on **VST Multitrack** and select **Lexicon USB ASIO** if it is not already selected. Click on **Switch** to select the driver, then click **OK**. You are now ready to begin recording using your Lambda Studio and Cubase LE.

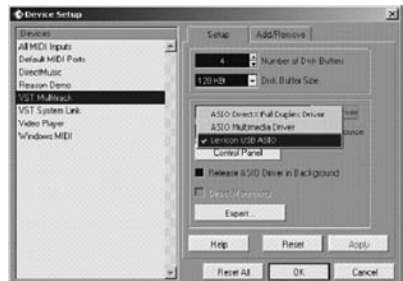

SECTION I – RECORDING AUDIO WITH THE LAMBDA STUDIO™

The diagram below shows how the Lambda Studio™ is connected for this particular setup.

A. RECORDING USING THE MICROPHONE/LINE INPUT

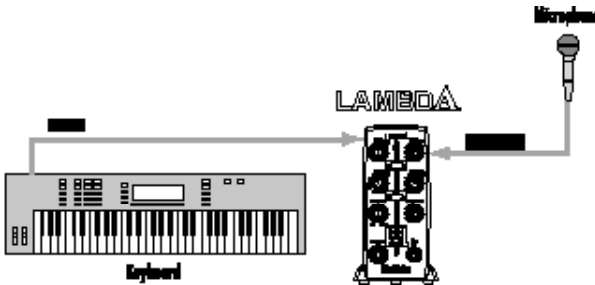

Plug your microphone cable into the **Mic 1** XLR jack or line level audio source to the **Line 1** ¼" jack on the back of the Lambda Studio. If the mic needs phantom power, engage the **+48 V** switch (on the back of the Lambda Studio).

To set up the software to record:

1. Open Cubase® LE.
2. Click **File** and select **New Project**.

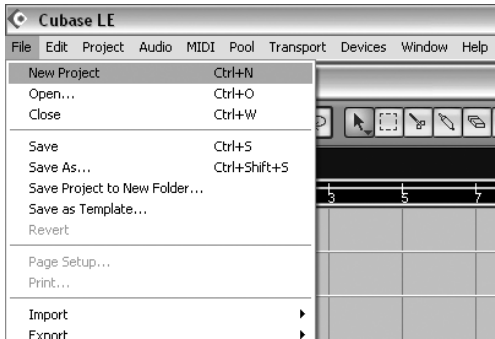

3. Select **Default** and click OK.



4. Select a location to store the project (or use the default location) and click **OK**.



To set the input of the track to record:

1. Click anywhere in the gray area (not on the buttons) of the **Track 1** window (labeled as **Audio 01**).



2. Click the **Show Inspector** button , located in the upper left corner of the screen. The Inspector window appears on the left side of the screen.



- In the Inspector, click the **IN:** box and select **IN 1** for the track input source. (**IN 1** relates to **Mic 1** and **Line 1**, **IN 2** relates to **Mic 2** and **Line 2**).

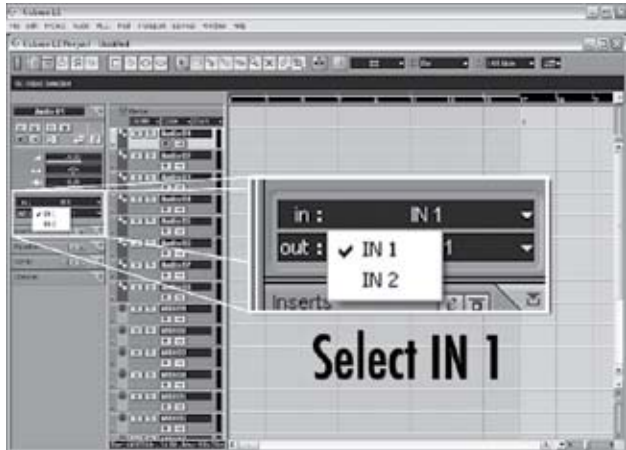

- In the **Track 1** window, the **Record Enable** button should already be red. If it isn't, click it so that it turns red.



- In the **Track 1** window, click the **Input Monitoring** button  so that it is not lit.

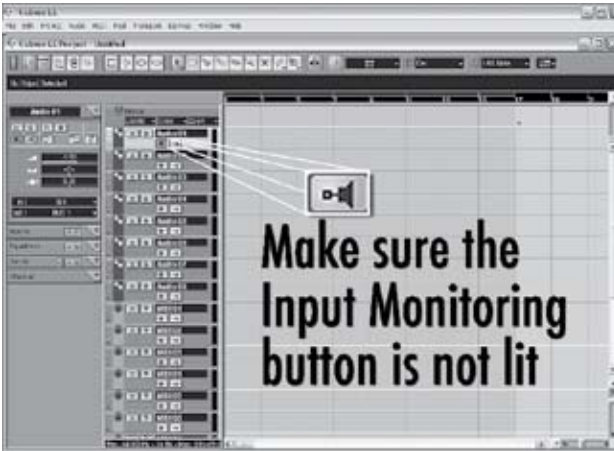

To check the input level from the microphone or Line Input:

1. If you are using a mic and have connected the Lambda Studio™ to some monitors, turn them down or off to avoid feedback.
2. If you want to hear the audio source in headphones, turn up the Lambda Studio™ **Output Level** knob and turn the **Monitor Mix** knob counter-clockwise (**towards the Direct side**), then press the **Monitor Assign** button between **Mic 1** and **Mic 2** or **Line 1** and **Line 2** so it is in the **Mono** position. This will let you hear output on both sides of your headphones when recording only one microphone or line level source.

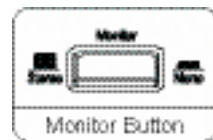
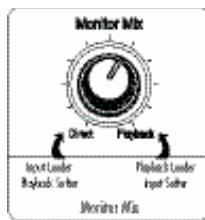

3. Speak or sing into the microphone or play the line level source while gradually increasing the gain by turning up the **Mic 1** or **Line 1** knob until you see the **Peak** LED light next to the **Mic 1** or **Line 1** knob flash occasionally. Check the **Input Bargraph Meter** on the front of the Lambda Studio to make sure you are not clipping the A/D converters (**although it's okay to light the -6 LED occasionally**).

To start recording:

1. Click the **Record** button on Cubase® LE's Transport control.

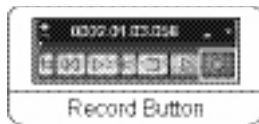

2. Speak or play an instrument into the microphone or line input.
3. When you are finished recording press the **Stop** button.



4. Press **Rewind** and press the **Play** button to listen to the track you have just recorded.



5. Turn the Lambda Studio™ **Output Level** knob to adjust the listening volume, and make sure the **Monitor Mix** knob is somewhere in the middle between **Direct** and **Playback**.

To overdub a second track:

1. Click anywhere in the gray area (**not on the buttons**) of the **Track 2** window (labeled as **Audio 02**).
2. In the Inspector, click the **IN:** box and select **IN 1** for Track 2's input. (**IN 1 relates to Mic 1 and Line 1, IN 2 relates to Mic 2 and Line 2**).
3. In the **Track 2** window, the **Record Enable** button should already be red. If it isn't, click it so that it turns red.
4. In the **Track 2** window, click the **Input Monitoring** button so that it is not lit.

To set monitor levels for a comfortable listening level:

1. On the front of the Lambda Studio hardware, locate the **Monitor Mix** knob.

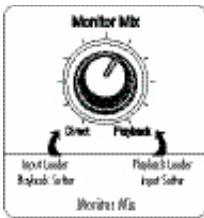

2. While playing back the recording, adjust the **Monitor Mix** knob to balance the levels between direct input signal and recording playback. To make the direct input louder than the recording playback in the headphones, turn the **Monitor Mix** knob towards the **Direct** side. To make the recorded track louder, turn the **Monitor Mix** knob towards the **Playback** side.

NOTE: Changing the **Monitor Mix** does not affect the recording level, only what you hear while recording. You can also adjust the playback level and pan position

of the original track in your monitor by adjusting the controls for channel 1 within Cubase® LE's Mixer window.

- Click on **Record** and record the second (**overdubbed**) track.

B. RECORDING A GUITAR USING THE INSTRUMENT INPUT

This section explains how to record using the ¼" **Instrument** input jack on the front panel.

- Plug your electric, acoustic, or bass guitar into the **Instrument** input jack on the front of the Lambda Studio™ hardware.



The **Instrument** input uses the same recording channel as the **Line 1** input; anything plugged into the ¼" **Line 1** input jack on the back of the Lambda Studio will not be recorded when a cable is connected to the ¼" **Instrument** input jack on the front panel.

NOTE: This jack is intended for electric guitar and bass, or acoustic instrument pickups, not line-level signals such as the output of keyboards or a direct out from a guitar amplifier. For those, use the **Line 1-2** input jacks on the back of the Lambda Studio hardware.

- Press the **Monitor Assign** button between **Line 1** and **Line 2** knobs so that it is in the **Mono** position.

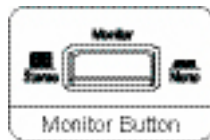

- Open Cubase LE, go to **File** and select **New Project>Default**, and a project location. (See Section I for more information.)

To set the input of the track to record from the 1-2 USB channels:

1. Click anywhere in the gray area (**not on the buttons**) of the **Track 1** window (labeled as **Audio 01**).
2. In the Inspector, click the **IN:** box and select **IN 1** for the track input source.
3. In the **Track 1** window, the **Record Enable** button should already be red. If it isn't, click it so that it turns red.
4. In the **Track 1** window, click the **Input Monitoring** button so that it is not lit.
5. Next, adjust the input gain of the **Instrument** input To set the input level, strum the guitar while gradually turning up the **Line 1** knob until the **Peak** LED lights occasionally with the loudest signals. Check the **Input Bargraph Meter** on the front of the Lambda Studio™ to make sure you are not clipping.
6. To begin recording, click the **Record** button on the Transport control. Play some chords or notes on the guitar. When you are finished recording, click **Stop**, then **Rewind**.

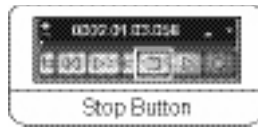
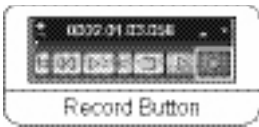

7. Click the **Play** button to listen to the track you have just recorded.



SECTION II - RECORDING MIDI WITH THE LAMBDA STUDIO™

The Lambda Studio™ also functions as a MIDI interface. This allows you to record MIDI data into a MIDI track of Cubase® LE, and play that MIDI data back from the computer into a keyboard, sound module or effects processor.

Here is an example of recording a MIDI track in Cubase LE using a MIDI keyboard:

1. To record MIDI data into the computer, connect the MIDI out from the keyboard to the **MIDI In** on the Lambda Studio. Connect the **MIDI Out** from the Lambda Studio hardware to the MIDI in on the keyboard.

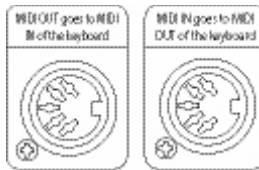

2. To hear your keyboard, you either need to run the line output of the keyboard to one (**mono**) or two (**stereo**) **Line** inputs on the back of the Lambda Studio, or use the keyboard's headphone output.
3. Open Cubase LE and start a new default project. Click on the gray area (**not on the buttons**) of the **MIDI Track 1** window (labeled **MIDI 01**).
4. In the Inspector, click the **IN:** box and select **Lexicon® USB MIDI**.
5. Click the **OUT:** box and select **Lexicon USB MIDI** for the MIDI outputs. Click the **Record Enable** button on MIDI track 1.



6. Click the **Record** button on the Transport and play your keyboard. You are now recording MIDI data from the keyboard. If you don't see data in the track, check the settings of the keyboard to make sure it's set to transmit on the same MIDI channel that Cubase LE is set to receive on. In some cases, you may want to set the keyboard to "local off" and set Cubase LE to "Echo" mode. For more information, consult the Cubase LE online manual and your keyboard's manual.

SECTION III - USING SOFTWARE INPUT MONITORING

The previous examples have turned off Cubase® LE's Input Monitoring software switches while recording tracks, and used the **Monitor Mix** knob on the front of the Lambda Studio™ hardware to directly monitor an input without latency. Software monitoring lets you listen to software-based effects in real time and adjust the monitor mix independently of the recording levels, but also introduces some latency (**delay**) into the input signal. The amount of latency depends on the amount of buffers assigned in the ASIO control panel. See page 32 for more information about adjusting buffer settings.

1. When using Cubase LE's input software monitoring with the Lambda Studio, you will want to set the **Monitor Mix** knob all the way to the **Playback** side.
2. Click the **Input Monitoring**  button on the track you are recording to. You will now be able to hear your input. Now you can try assigning an effect on the input. This example assigns a Pantheon™ reverb.
3. Click the **Track Edit** button.



4. Click on an **Insert**.



5. Select **Lexicon®** and **Pantheon™**.

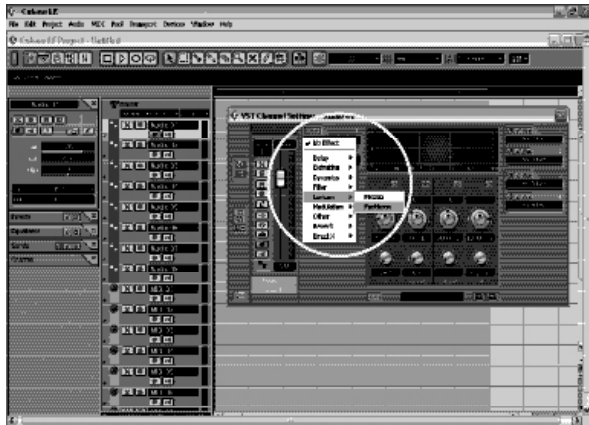

- Choose **Large Hall** from the drop down menu at the top of the Pantheon™ Edit Window.



- Because this is an insert effect, move the **Mix** slider to 50% (see the Pantheon manual for more details).



- Change the level to about -52dB. Now you will record with the Lexicon® Pantheon Reverb on your track.

SECTION IV - ADJUSTING THE BUFFER SETTINGS

Audio latency is the minimum time required for a computer to store recorded audio from an audio interface into the recording application memory and playback that same recorded audio back out audio interface output.

After the audio has been converted to the digital domain, it is passed to a **buffer** before it is processed by the driver and then passed to the audio application. An audio buffer is a reserved segment of memory used to hold this advance portion of audio data to compensate for momentary delays in processing. The size of an audio buffer is the maximum number of samples the buffer can hold. For sound coming from the computer, there is an output buffer before the digital to analog conversion. "Buffering" introduces latency, since a buffer needs to fill up by a certain amount before the data can continue along the chain.

The buffers in Cubase® LE were automatically set at a safe setting for your computer when you installed the software. If you are using Input Monitoring, you may wish to adjust the amount of buffering to reduce this latency, or perceived delay in the input vs. output of audio. Lowering the buffers will lower the amount of latency when using Input Monitoring. Setting the buffers too low will result in unwanted digital artifacts, such as popping or crackling and possibly audio dropout. The faster the computer (**Hard Disk and CPU**), the lower you will be able to adjust the buffer setting without negatively impacting the audio. For more information, consult the Cubase online documentation.

A. ADJUSTING THE BUFFERS IN WINDOWS® XP

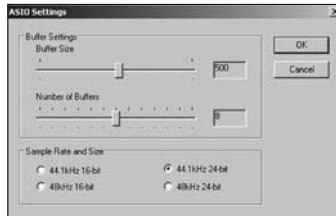

1. Open Cubase LE and go to **Devices>Device Setup**.
2. Click on **VST Multitrack**.
3. Click the **Control Panel** button. You will now see the ASIO control panel. The top slider is the buffer size; this number gets multiplied by the bottom slider, labeled **Number of Buffers**.
4. When you are finished adjusting the buffer size, click the **OK** button and return to your project to test the results.

B. ADJUSTING THE BUFFERS IN MAC® OSX

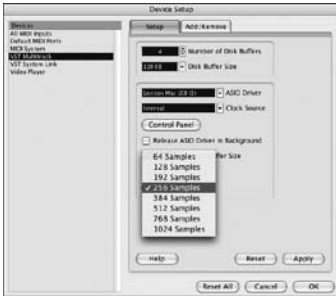

1. Open Cubase LE and go to **Devices>Device Setup**.
2. Click on **VST Multitrack**.
3. Click on **Audio Buffer Size** and select the **Number of Samples**.
4. When you are finished click **OK**.

SPECIFICATIONS

| | |
|------------------------------|--|
| Microphone Inputs: | (2) Female XLR Pin 2 Hot |
| Input Impedance: | 600 Ohms balanced |
| Phantom Power: | +48 Volt |
| GAIN: | +50 dB |
| EIN: | -120 dB A-weighted @ 50dB gain (150 Ohm source impedance) |
| Maximum Input Level: | +18 dBu |
| Frequency Response: | +0, -0.2 dB 20 Hz - 20 kHz, ref. 1 kHz |
| THD+N: | <.005%, 20 Hz - 20 kHz |
| Insert Inputs: | (2) 1/4" TRS |
| Send Level (tip): | +19 dBu maximum |
| Maximum Return Level (ring): | +19 dBu maximum |
| Line Inputs: | (2) 1/4" TRS balanced or unbalanced |
| Input Impedance: | 20 kOhm balanced, 10 kOhm unbalanced |
| Maximum Input Level: | +22 dBu |
| Frequency Response: | +0, -0.2 dB 20 Hz - 20 kHz, ref. 1kHz |
| THD+N: | <.009% A/D, 20 Hz - 20 kHz |
| Instrument Input: | (1) 1/4" mono jack |
| Input Impedance: | 1 MOhm unbalanced |
| Maximum Input Level: | +19 dBu |
| Frequency Response: | +0, -0.25 dB 20 Hz - 20 kHz, ref. 1 kHz |
| THD+N: | <.0125% A/D |
| Crosstalk: | <-74dB any input or output to any recording channel, 20 Hz-20 kHz <-95dB at 1 kHz typical |
| Line Outputs: | (2) 1/4" TRS balanced or unbalanced |
| Level: | +19 dBu maximum (+4 dBu nominal input = -15 dBFS) |
| Impedance: | 110 Ohms |
| Headphone Output: | (1) 1/8" stereo jack 100 mW per channel at 50 Ohms |
| MIDI Interface: | 5 pin DIN connectors for MIDI in and MIDI out |
| Sample Rate: | 44.1 kHz or 48 kHz (determined by computer application) |
| Dynamic Range: | A/D (24 Bit) 104 dB typical, A-weighted, 20 Hz - 20 kHz D/A (24 Bit) 109 dB typical, A-weighted, 20 Hz - 20 kHz |
| A/D/A (24 Bit) | 103 dB typical, A-weighted, 20 Hz - 20 kHz |
| Analog Path: | 118 dB typical, A-weighted, 20 Hz - 20 kHz |
| USB Type B Socket: | Version 1.1, Version 1.1 hubs are not supported |
| Power Requirements: | USB powered |
| Dimensions: | XXX x XXX x XXX |
| Weight: | XXX lbs. |

Lexicon engineers are constantly working to improve the quality of our products. Specifications are therefore subject to change without notice.

Lambda Signal Routing Diagram

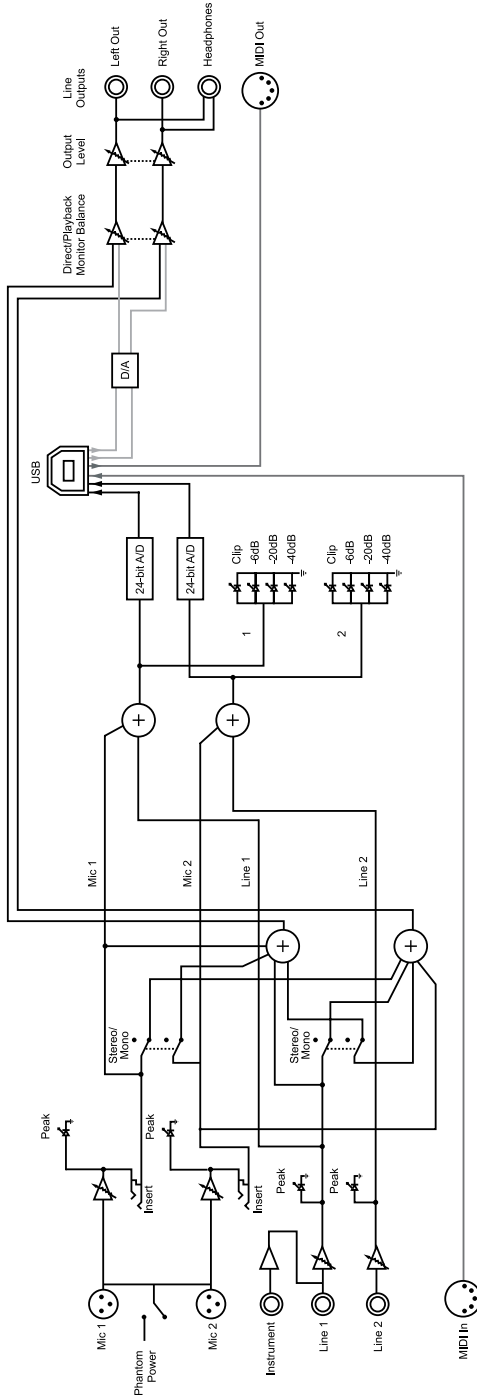



Harman Music Group
8760 South Sandy Parkway | Sandy, Utah 84070 U.S.A.
Phone: (801)-568-7660 | Fax: (801)-568-7662

Lambda Desktop Recording Studio™
Questions or comments?
Email us at: customer@lexiconpro.com
or visit our World Wide Web home page at: www.lexiconpro.com

Copyright 2005 Lexicon Professional*

 A Harman International Company

Part Number: 18-0350-A

Free Manuals Download Website

<http://myh66.com>

<http://usermanuals.us>

<http://www.somanuals.com>

<http://www.4manuals.cc>

<http://www.manual-lib.com>

<http://www.404manual.com>

<http://www.luxmanual.com>

<http://aubethermostatmanual.com>

Golf course search by state

<http://golfingnear.com>

Email search by domain

<http://emailbydomain.com>

Auto manuals search

<http://auto.somanuals.com>

TV manuals search

<http://tv.somanuals.com>