



Z13 Color Jetprinter™

Z23 Color Jetprinter

Z33 Color Jetprinter

From Setup to Printing

**for Windows 98, Windows Me, Windows 2000,
Mac OS 8.6 to 9.1, and Mac OS X**

April 2001

Edition: April 2001

The following paragraph does not apply to any country where such provisions are inconsistent with local law: LEXMARK INTERNATIONAL, INC., PROVIDES THIS PUBLICATION "AS IS" WITHOUT WARRANTY OF ANY KIND, EITHER EXPRESS OR IMPLIED, INCLUDING, BUT NOT LIMITED TO, THE IMPLIED WARRANTIES OF MERCHANTABILITY OR FITNESS FOR A PARTICULAR PURPOSE. Some states do not allow disclaimer of express or implied warranties in certain transactions; therefore, this statement may not apply to you.

This publication could include technical inaccuracies or typographical errors. Changes are periodically made to the information herein; these changes will be incorporated in later editions. Improvements or changes in the products or the programs described may be made at any time.

Comments about this publication may be addressed to Lexmark International, Inc., Department F95/032-2, 740 West New Circle Road, Lexington, Kentucky 40550, U.S.A. In the United Kingdom and Eire, send to Lexmark International Ltd., Marketing and Services Department, Westhorpe House, Westhorpe, Marlow Bucks SL7 3RQ. Lexmark may use or distribute any of the information you supply in any way it believes appropriate without incurring any obligation to you. You can purchase additional copies of publications related to this product by calling 1-800-553-9727. In the United Kingdom and Eire, call 0628-481500. In other countries, contact your point of purchase.

References in this publication to products, programs, or services do not imply that the manufacturer intends to make these available in all countries in which it operates. Any reference to a product, program, or service is not intended to state or imply that only that product, program, or service may be used. Any functionally equivalent product, program, or service that does not infringe any existing intellectual property right may be used instead. Evaluation and verification of operation in conjunction with other products, programs, or services, except those expressly designated by the manufacturer, are the user's responsibility.

Lexmark and Lexmark with diamond design are trademarks of Lexmark International, Inc., registered in the United States and/or other countries. Color Jetprinter is a trademark of Lexmark International, Inc.

Mac OS and Macintosh are trademarks of Apple Computer, Inc., registered in the United States and other countries.

Other trademarks are the property of their respective owners.

© Copyright 2001 Lexmark International, Inc. All rights reserved.

UNITED STATES GOVERNMENT RESTRICTED RIGHTS

This software and documentation are provided with RESTRICTED RIGHTS. Use, duplication or disclosure by the Government is subject to restrictions as set forth in subparagraph (c)(1)(ii) of the Rights in Technical Data and Computer Software clause at DFARS 252.227-7013 and in applicable FAR provisions: Lexmark International, Inc., Lexington, KY 40550.

FCC emissions information

The Lexmark Z13 Color Jetprinter, Type 4104; Lexmark Z23 Color Jetprinter, Type 4105; and Lexmark Z33 Color Jetprinter, Type 4105, have been tested and found to comply with the limits for a Class B digital device, pursuant to Part 15 of the FCC Rules. Operation is subject to the following two conditions: (1) this device may not cause harmful interference, and (2) this device must accept any interference received, including interference that may cause undesired operation.

Any questions regarding this compliance information statement should be directed to:

Director of Lab Operations
Lexmark International, Inc.
740 West New Circle Road
Lexington, KY 40550
(859) 232-3000

Please refer to the online information for details.

Safety information

- Use only the Lexmark power supply provided with this product or an authorized Lexmark replacement power supply.
- Connect the power cord to an electrical outlet that is near the product and easily accessible.
- Refer service or repairs, other than those described in the manual, to a professional service person.

ENERGY STAR

The EPA ENERGY STAR Computers program is a partnership effort with computer manufacturers to promote the introduction of energy-efficient products and to reduce air pollution caused by power generation.

Companies participating in this program introduce personal computers, printers, monitors, or fax machines that power down when they are not being used. This feature will cut the energy used by up to 50 percent. Lexmark is proud to be a participant in this program.

As an ENERGY STAR Partner, Lexmark International, Inc. has determined that this product meets the ENERGY STAR guidelines for energy efficiency.

Japanese VCCI notice

この装置は、権利保護法第9条電磁障害防止規則協議会（VCCI）の基準に基づいてクラスBの電磁放射レベルで設計されています。この装置は、家庭環境で使用することを目的としていますが、この装置がラジオやテレビジョン受信機に近接して使用されると、受信機を妨害する可能性があります。
取扱説明書に詳しく説明されています。



From Setup to Printing

This booklet takes you step by step from setup through printing your first document using Windows 98, Windows Me, Windows 2000, Mac OS 8.6 to 9.1, or Mac OS X.

Printer software and documentation for other operating systems (such as Linux) may be available on the Lexmark Web site. (For more information, see page 17.) If your printer documentation includes an online *User's Guide*, you will need Adobe Acrobat Reader 4.0x.

See page 17 for information about contacting Lexmark and locating your printer warranty.

Setup

For setup, you will need:

- A computer with a CD-ROM drive and USB port
- A USB cable (such as Lexmark P/N 12A2405) purchased separately
- Letter or A4 size paper

Follow the steps beginning on page 1 to set up your printer.

For additional help while setting up your printer, see:

- Page 11 for Windows 98, Windows Me, or Windows 2000
- Page 16 for Mac OS 8.6 to 9.1 or Mac OS X

Step 1: Make sure your computer is on



Windows 98
Windows Me
Windows 2000



Mac OS 8.6 to 9.1
Mac OS X

Step 2: Check the printer parts

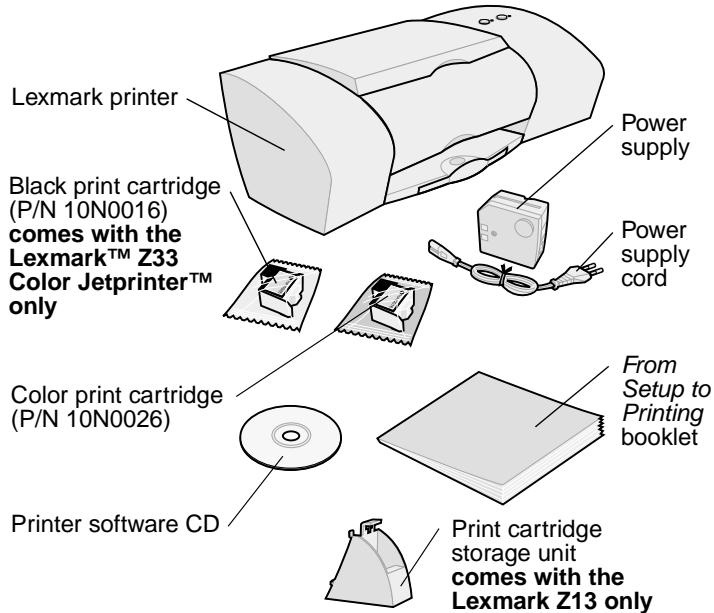

To install the print cartridge storage unit, refer to:

- Windows: Printer software Help (see page 9)
- Mac OS 8.6 to 9.1: *User's Guide* (see page 13)
- Mac OS X: Printer software Help (see page 15)

If any items are missing, contact Lexmark (see page 17).

Step 3: Connect the power supply

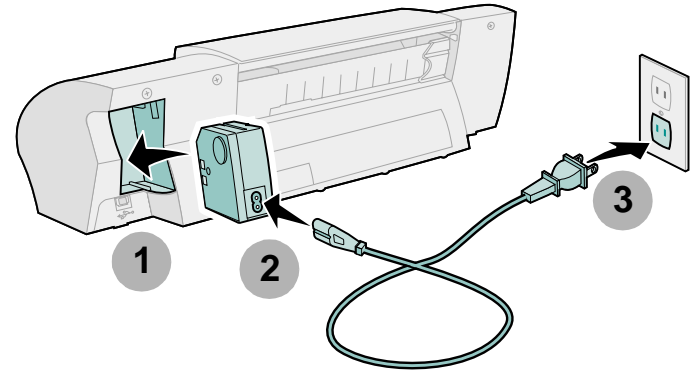

If the Power light doesn't come on:

- 1 Check the power supply connections.
- 2 Press the Power button.

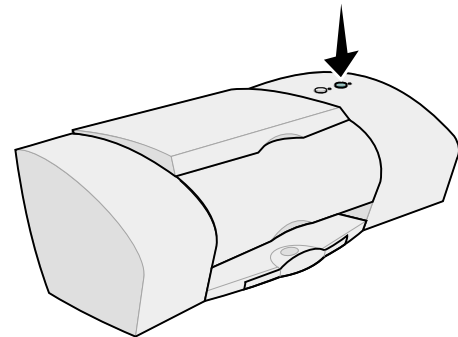

Step 4: Install the print cartridges

If you own a:	Your printer came with:	You can print with:
Lexmark Z13	Color print cartridge (P/N 10N0026)	<ul style="list-style-type: none"> • Only the color print cartridge • Only a black print cartridge*
Lexmark Z23	Color print cartridge (P/N 10N0026)	<ul style="list-style-type: none"> • Both a color and a black print cartridge* • Only the color print cartridge in the left carrier • Only a black print cartridge* in the right carrier
Lexmark Z33	Color print cartridge (P/N 10N0026) Black print cartridge (P/N 10N0016)	<ul style="list-style-type: none"> • Both the color and the black print cartridge • Only the color print cartridge in the left carrier • Only the black print cartridge in the right carrier
* You can purchase a black print cartridge (P/N 10N0016) separately.		

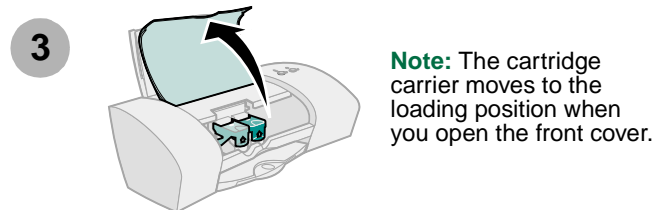
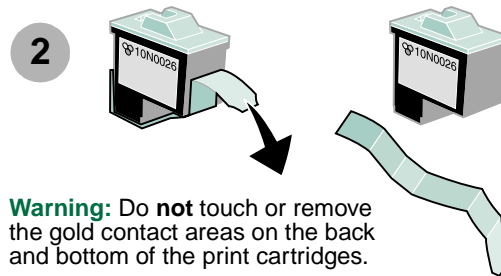
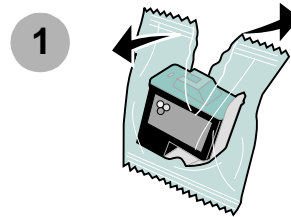

Lexmark Z13

Lexmark Z23

Lexmark Z33

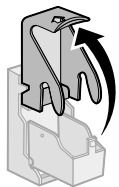

4



4

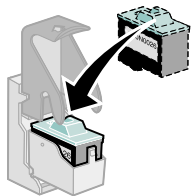
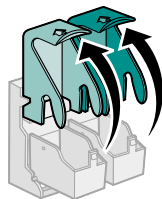

5

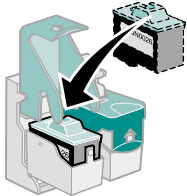

5

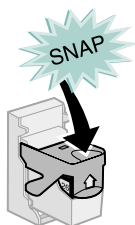
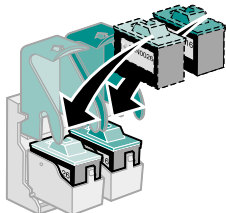

6

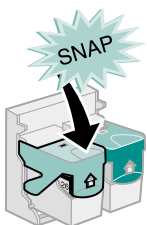

6

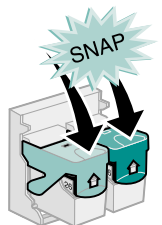

7

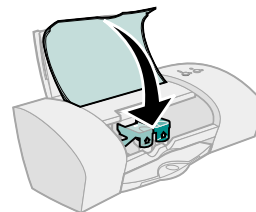

Step 5: Connect the USB cable

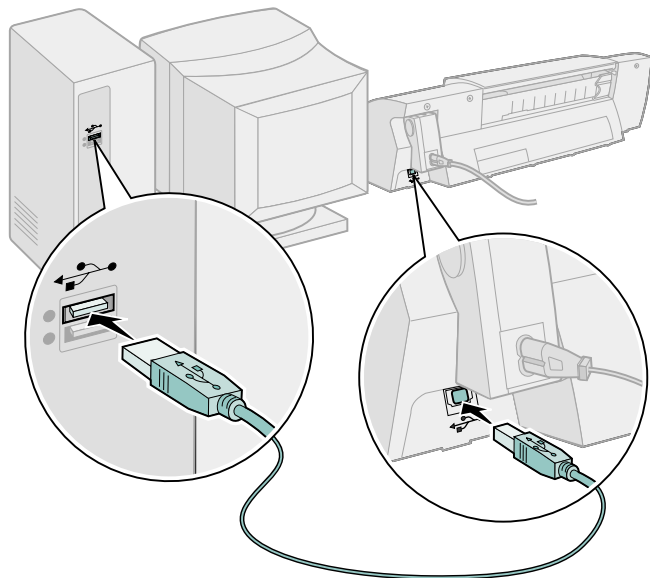

Note: The location and orientation of the USB port on your computer may be different from the one shown.

Step 6: Load up to 100 sheets of plain paper

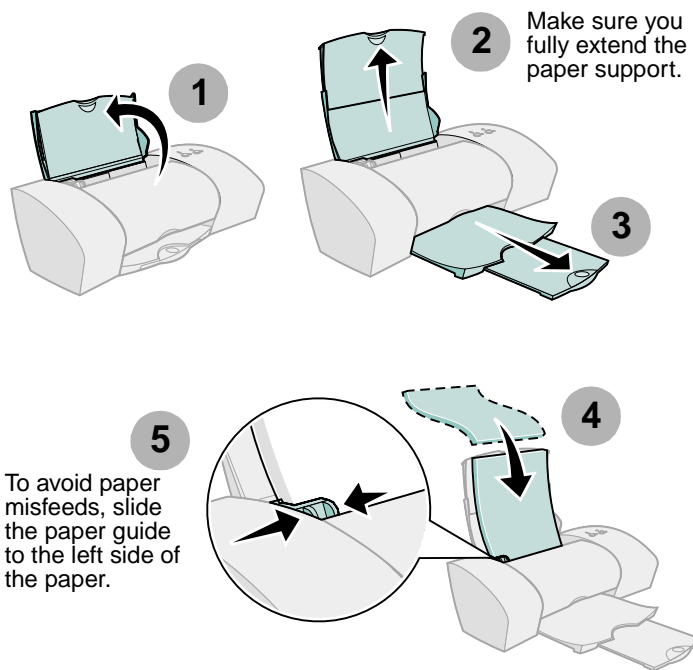

To avoid paper misfeeds, slide the paper guide to the left side of the paper.

Note: A4 size paper should extend slightly above the top of the paper support. Letter size paper should align with the top of the paper support.

Step 7: Install the printer software

Now that you have set up your printer, you are ready to install the printer software.

Follow all of the steps for your operating system.

Operating system:	Page:
Windows 98, Windows Me, and Windows 2000	6
Mac OS 8.6 to 9.1	12
Mac OS X	14

Printer software for other operating systems (such as Linux) may be available on the Lexmark Web site. (For more information, see page 17.) When you download the software, installation information is included in the readme file.

Windows

Note: To install the printer software for Mac OS 8.6 to 9.1, see page 12. To install the printer software for Mac OS X, see page 14.

Your software screens may look slightly different from the ones shown in this booklet, depending on your printer model and operating system. The arrows show you where to click.



- 3 Wait for the Lexmark printer software installation screen shown in step 4 to appear. If it doesn't, see page 11.

4



5



6

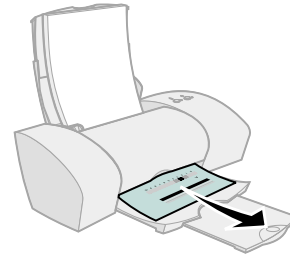

If the alignment page doesn't print:

- Make sure you installed the print cartridges correctly (see page 3).
- Follow the instructions on any error message on your screen. Click the ? on the error message for help.

7



a

Follow the instructions on the screen to enter alignment values using the page printed in step 6.

b

8



9

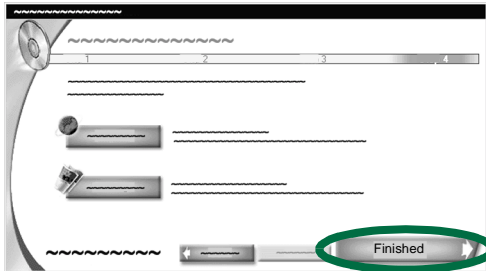

Printing from Windows

Now that you have set up your printer and installed the printer software, you are ready to print your first document.

Basic printing is as easy as:

- 1 Load the paper.
- 2 Open the file you want to print.
- 3 Customize the printer settings. For help, see the next section, "Using the printer software."
- 4 Print your document.

Using the printer software

Use the **Printer Properties** (or **Printing Preferences**) to customize settings so your document prints the way you want it. You can open the Printer Properties from your software application.

For example, to print the first page of the Read Me file:

- 1 Load plain paper. For help, see page 5.
- 2 From the Start menu on your desktop, click **Programs** ▶ *the name of your printer* ▶ **Read Me**.

3 Customize the printer settings:

a **Windows 98 and Windows Me:** From the Read Me file, click **File** ▶ **Print** ▶ **Properties**.

Windows 2000: From the Read Me file, click **File** ▶ **Print**. From the Printer Settings tab, click **Change**.

Note: For some software applications in Windows 2000, follow the instructions for Windows 98 and Windows Me to open the Printing Preferences.

Printer Properties

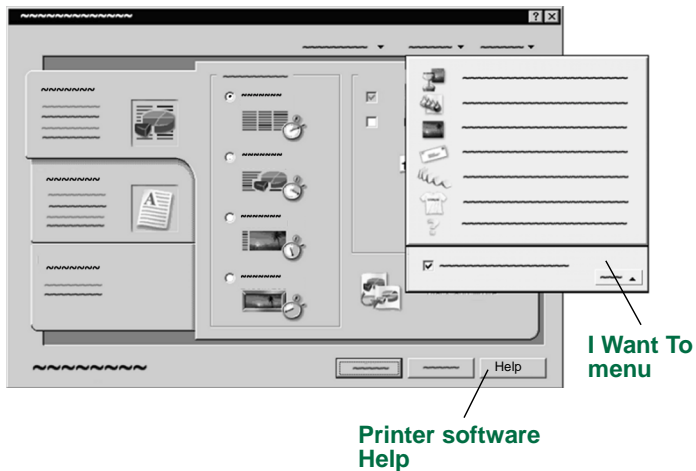

b From the Quality/Copies tab, select **Quick Print** to print the Read Me file *quickly*.

Note: Selecting a higher Quality/Speed setting results in better print quality, but your documents may take longer to print.

c To learn more:

- Explore the other tabs in the Printer Properties.
- Explore the menus. Use the **I Want To menu** as a guide for printing photographs, envelopes, iron-on transfers, and more.
- Click **Help** to view the **printer software Help**. From the File menu, click **Exit** when you are finished.

d Click **OK** to apply the settings and close the Printer Properties.

4 **Windows 98 and Windows Me:** In the Pages area of the Print dialog box, type **1** in the From: and To: text boxes.

Windows 2000: On the General tab, type **1** in the Pages text box.

5 Click **OK** to print the first page of the Read Me file.

6 From the File menu, click **Exit** to close the Read Me file.

You can do more than customize your printer settings in the printer software. You can also use **The Lexmark Solution Center** as your complete guide to:

- Printer features, such as printing photos, envelopes, and banners
- Solving printing problems (troubleshooting)
- Ordering, installing, and maintaining supplies
- Information about contacting Lexmark

For example, to see how much ink is left in your cartridges:

- 1 From your desktop, double-click the Lexmark Solution Center icon.

Note: Your screen may look different depending on your printer model and the cartridges you installed.

The Lexmark Solution Center

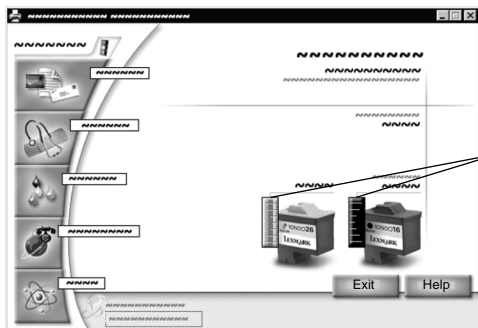

- 2 To learn more:

- Explore the tabs in the Lexmark Solution Center.
- Click **Help** to view the **printer software Help**. From the File menu, click **Exit** when you are finished.

- 3 Click **Exit** to close the Lexmark Solution Center.

Congratulations!

You are finished setting up your printer for Windows.

Need help during setup?

Note: For help with Macintosh, see page 16.

The installation screen didn't appear.

- 1 Make sure you click **Cancel** on any screens similar to the one in step 1 on page 6.
- 2 Make sure the Lexmark printer software CD is in your CD-ROM drive.
- 3 From the desktop, double-click **My Computer**.
- 4 Double-click the CD-ROM drive icon.
- 5 If necessary, double-click **setup.exe**.
- 6 Continue with step 4 on page 7.

The printer isn't working.

Try the following:

- Check the printer status:
 - a From the Start menu, click **Settings ▶ Printers**.
 - b From the Printers folder, double-click the icon for your printer.
 - c From the Printer menu, make sure:
 - **Default Printer** is selected.
 - **Pause Printing** is not selected.

- If you have a device such as a scanner or fax machine, disconnect your printer from the device and connect the printer directly to your computer.
- Check the printer port:
 - a From the File menu of a software application, click **Print or Printer Setup**.
 - b In the Where area, make sure your printer port is set to **USB**.
- Make sure you have not installed multiple copies of the printer software:
 - a From the Start menu, click **Settings ▶ Printers**.
 - b In the Printers folder, make sure there is only one icon for your printer.

If there is still a problem, uninstall and then reinstall the printer software:

- 1 From the Start menu, click **Programs ▶ the name of your printer ▶ Uninstall**.
- 2 Follow the instructions on your screen.
- 3 To reinstall the printer software, see page 6.

The Paper Feed light is blinking.

If there is an error message on your screen, follow the instructions on it. Click the ? on the error message for help.

Mac OS 8.6 to 9.1

Note: To install the printer software for Windows, see page 6. To install the printer software for Mac OS X, see page 14.

1 Close all open software applications.

2

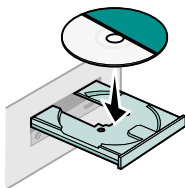

3

Wait for the Lexmark Installation dialog shown in step 4 to appear. If it doesn't, see page 16.

Your software screens may be slightly different from the ones shown in this booklet. The arrows show you where to click.

4

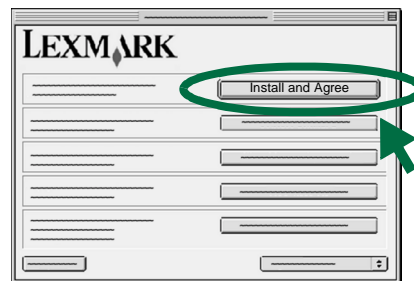

5

From the Country Selection dialog, select your country or region, and then click **Continue**.

6

From the Cartridge Changed dialog, click **Yes**.
An alignment page prints.

Note: If the alignment page doesn't print correctly, refer to the **Troubleshooting** topic in the *User's Guide for Mac OS 8.6 to 9.1*. To open the *User's Guide*, see page 13.

7 Follow the instructions on your screen to enter alignment values using the page printed in step 6, and then click **OK**.

8 From the Setup Complete dialog, click **Finished**.

Printing from Mac OS 8.6 to 9.1

Now that you have set up your printer and installed the printer software, you are ready to print your first document.

Basic printing is as easy as:

- 1 Load the paper.
- 2 Open the file you want to print.
- 3 Customize the printer settings.
- 4 Print your document.

The *User's Guide for Mac OS 8.6 to 9.1* contains printing instructions and ideas, maintenance tips, and troubleshooting information. To open the *User's Guide*:

- 1 From your desktop, double-click the folder for your printer.

2 Double-click the **Lexmark Users Guide.pdf** icon.

User's Guide for Mac OS 8.6 to 9.1

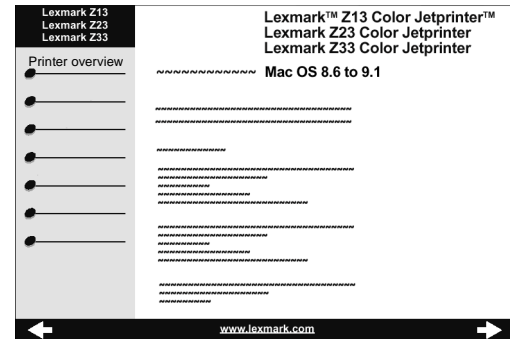

- 3 Click **Printer overview** to learn how to customize the printer settings using the printer software.
- 4 When you are finished, click **File ▶ Quit**.

Congratulations!

You are finished setting up your printer for Mac OS 8.6 to 9.1.

Mac OS X

Note: To install the printer software for Windows, see page 6. To install the printer software for Mac OS 8.6 to 9.1, see page 12.

1 Close all open applications.

2

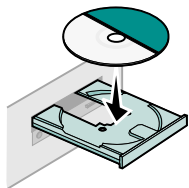

3 Wait for the Lexmark printer software installation screen to appear. If it doesn't appear, see page 16.

4 From the Installer dialog, click **Install and Agree**.

5 From the Country Selection dialog, select your country, and then click **Continue**. The Print Center opens.

6 From the Printer List, click the **red close button**.

7

From the Cartridge Alignment dialog, click **Continue**.

An alignment page prints.

Note: If the alignment page doesn't print:

- Make sure you installed the print cartridges correctly (see page 3).
- Follow the instructions on any error message on your screen.

8

Follow the instructions on your screen to enter alignment values using the page printed in step 7, and then click **Continue**.

9

From the Setup Exit dialog, click **Finished**.

Printing from Mac OS X

Now that you have set up your printer and installed the printer software, you are ready to print your first document.

Basic printing is as easy as:

- 1 Load the paper.
- 2 Open the file you want to print.
- 3 Customize the printer settings.
- 4 Print your document.

Using the printer software

The **Lexmark Solution Center** is your complete guide to:

- Printer features, such as printing photos, envelopes, and more
- Solving printing problems (troubleshooting)
- Ordering, installing, and maintaining supplies
- Information about contacting Lexmark

For example, to see how much ink is left in your cartridges:

- 1 From the Dock, click the **Finder icon**.
- 2 From the Finder window, click **Applications**.
- 3 From the Applications folder, double-click the **Lexmark folder**.

- 4 From the Lexmark folder, double-click the **Lexmark Solution Center icon**.

Note: Your screen may look different depending on your printer and the cartridges you installed.

The Lexmark Solution Center

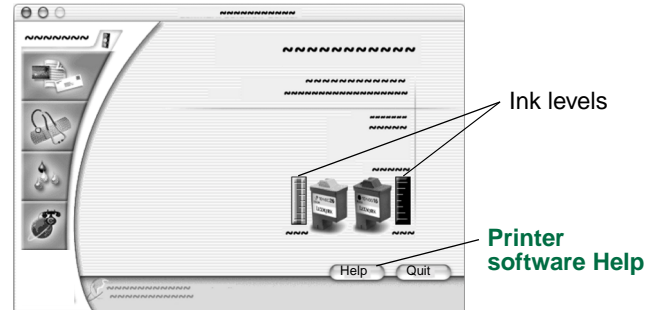

- 5 To learn more:
 - Explore the tabs in the Lexmark Solution Center.
 - Click **Help** to view the **printer software Help**. From the File menu, click **Quit** when you are finished.
- 6 Click **Quit** to close the Lexmark Solution Center.

Congratulations!

You are finished setting up your printer for Mac OS X.

Need help during setup?

Note: For help with Windows, see page 11.

The installation screen didn't appear.

- 1 Make sure the Lexmark printer software CD is in your CD-ROM drive.
- 2 From your desktop, double-click the Lexmark CD icon for your printer.
- 3 From the CD folder, double-click the Install icon.
- 4 **Mac OS 8.6 to 9.1:** Continue with step 4 on page 12.
Mac OS X: Continue with step 4 on page 14.

The printer isn't working.

Mac OS 8.6 to 9.1

- 1 From the Apple menu, choose **Chooser**.
- 2 Select your printer in the left window of the Chooser.
If your printer is **not** shown in the left window of the Chooser, install the printer software (see page 12).
- 3 Make sure an icon for your printer is in the Connect to: box of the Chooser.
If it isn't, check your USB cable connection and repeat step 2 and step 3.
- 4 From the desktop, select the icon for your printer.

- 5 From the menu bar, choose **Printing**.
- 6 Make sure **Set Default Printer** and **Start Print Queue** are both selected.

Mac OS X

First, check your USB cable connection. If your printer still isn't working:

- 1 From the Dock, click the **Finder icon**.
- 2 From the Finder window, click the **Applications** button at the top of the screen.
- 3 Double-click the **Utilities folder**.
- 4 Double-click the **Print Center icon**.

If your printer is **not** listed, install the printer software (see page 14).

- 5 Select your printer in the Printer List.
- 6 From the Printers menu, choose **Make Default**.
- 7 From the Printers menu, choose **Show Queue**.
- 8 From the Queue menu:
 - a Choose **Start Queue**, if available.
 - b Choose **Resume Job**, if available.

The Paper Feed light is blinking.

If there is an error message on your screen, follow the instructions on it. Click the ? on the error message for help.

Contacting Lexmark

Visit our Web site at www.lexmark.com to:

- Receive technical support.
- Register your printer.
- Access publications for your printer.
- Check for free offers.

To contact our Customer Support Center:

- **Windows**

- a Insert the printer software CD into your CD-ROM drive.

- b Click **Contact Lexmark ▶ Technical Support**.

You can also view customer support information from the Lexmark Solution Center by clicking **Contact Information ▶ Customer Support**.

- **Mac OS 8.6 to 9.1**

- a Insert the printer software CD into your CD-ROM drive.

- b Click **Contact Lexmark**.

You can also view this customer support information from the folder for your printer by double-clicking **Technical Support**.

- **Mac OS X**

- a Insert the printer software CD into your CD-ROM drive.

- b Click **Contact Lexmark**.

You can also view this customer support information from the Lexmark Solution Center by clicking **Contacting Lexmark**.

Locating your warranty information

Warranty information is provided with your printer.



Lexmark and Lexmark with diamond design are trademarks of Lexmark International, Inc., registered in the United States and/or other countries.

Color Jetprinter is a trademark of Lexmark International, Inc.

© 2001 Lexmark International, Inc.

740 West New Circle Road

Lexington, Kentucky 40550

Free Manuals Download Website

<http://myh66.com>

<http://usermanuals.us>

<http://www.somanuals.com>

<http://www.4manuals.cc>

<http://www.manual-lib.com>

<http://www.404manual.com>

<http://www.luxmanual.com>

<http://aubethermostatmanual.com>

Golf course search by state

<http://golfingnear.com>

Email search by domain

<http://emailbydomain.com>

Auto manuals search

<http://auto.somanuals.com>

TV manuals search

<http://tv.somanuals.com>