



Z2400 Series User's Guide

2007

www.lexmark.com

Contents

Safety information.....	7
Introduction.....	8
Finding information about the printer.....	8
Understanding the printer.....	10
Bypassing security warnings during software installation.....	10
Understanding the parts of the printer.....	10
Understanding the printer software.....	12
Installing printer software	12
Installing the optional XPS driver (Windows Vista users only)	12
Using the Windows printer software.....	13
Using the Macintosh printer software.....	14
Installing the printer on a wireless network.....	16
Wireless network compatibility.....	16
Information you will need to set up the printer on a wireless network.....	16
Installing the printer on a wireless network.....	17
Interpreting the colors of the Wi-Fi indicator light.....	17
Configuring an IP address manually.....	18
Changing wireless settings after installation.....	18
Installing the printer on other computers.....	19
Advanced wireless setup.....	20
Creating an ad hoc wireless network	20
Adding a printer to an existing ad hoc wireless network	23
Frequently asked questions.....	23
What is a network?	23
How are home networks configured?	24
Why do I need an installation cable?	26
How do I attach the installation cable?.....	26
What is the difference between infrastructure and ad hoc networks?	27
Finding the signal strength	28
What is an SSID?	28
How do I find out what type of security my network is using?	28
Can I use my printer on a USB and a wireless connection at the same time?.....	28
What is a MAC address?	28
How do I find the MAC address?	29
What is an IP address?	29

How do I locate IP addresses?	29
How are IP addresses assigned?	30
What is a key index?	31
Loading paper.....	32
Loading paper.....	32
Loading various paper types.....	32
Printing.....	34
Printing basic documents.....	34
Printing a document.....	34
Printing Web pages.....	34
Printing multiple copies of a document.....	35
Collating printed copies.....	35
Printing the last page first (reverse page order).....	36
Printing multiple pages on one sheet (N-Up).....	36
Pausing print jobs.....	37
Canceling print jobs.....	38
Printing specialty documents.....	38
Printing envelopes	38
Printing labels	39
Printing on custom-size paper.....	40
Printing other specialty documents	41
Saving and deleting print settings.....	41
Working with photos.....	43
Using recommended paper.....	43
Printing photos.....	43
Printing photos from a CD or removable storage device connected to the computer	43
Maintaining the printer.....	45
Maintaining print cartridges.....	45
Installing print cartridges.....	45
Removing used print cartridges.....	46
Refilling print cartridges.....	46
Using genuine Lexmark print cartridges.....	46
Aligning the print cartridges	47
Cleaning the print cartridge nozzles.....	47
Wiping the print cartridge nozzles and contacts.....	48
Preserving the print cartridges	49
Cleaning the exterior of the printer.....	49
Ordering supplies.....	50

Ordering print cartridges	50
Ordering paper and other supplies.....	50

Troubleshooting.....52

Using the printer troubleshooting software (Windows only).....	52
Setup troubleshooting.....	52
Power button is not lit	52
Software did not install.....	53
Page does not print.....	54
Solving printer power problems.....	56
Removing and reinstalling the software	57
Enabling the USB port in Windows	58
Wireless troubleshooting.....	58
Printing a network setup page	58
Wireless troubleshooting checklist	59
Wireless configuration does not continue after the USB cable is attached	59
Cannot print over wireless network.....	60
Cannot print and there is a firewall on the computer	63
Wi-Fi indicator light is not lit.....	63
Wi-Fi indicator light is green but the printer does not print (Windows only)	63
Wi-Fi indicator light is blinking orange during installation (Windows only).....	65
Wi-Fi indicator light is blinking orange during installation (Macintosh only)	67
Wi-Fi indicator light is still orange	69
Wireless print server not installed	70
“Communication not available” message displays when printing wirelessly	71

Notices.....72

Product information.....	72
Edition notice.....	72
European EC directives conformity statement for radio products.....	75
Power consumption.....	78

Networking glossary.....83

Index.....85

Safety information

Use only the power supply and power supply cord provided with this product or the manufacturer's authorized replacement power supply and power supply cord.

Connect the power supply cord to an electrical outlet that is near the product and easily accessible.

 **CAUTION—POTENTIAL INJURY:** Do not twist, bind, crush, or place heavy objects on the power cord. Do not subject the power cord to abrasion or stress. Do not pinch the power cord between objects such as furniture and walls. If the power cord is misused, a risk of fire or electrical shock results. Inspect the power cord regularly for signs of misuse. Remove the power cord from the electrical outlet before inspecting it.

Refer service or repairs, other than those described in the user documentation, to a professional service person.

This product is designed, tested, and approved to meet strict global safety standards with the use of specific Lexmark components. The safety features of some parts may not always be obvious. Lexmark is not responsible for the use of other replacement parts.

 **CAUTION—SHOCK HAZARD:** Do not set up this product or make any electrical or cabling connections, such as the power supply cord or telephone, during a lightning storm.

SAVE THESE INSTRUCTIONS.

Introduction

Finding information about the printer

Publications

See the	For
<i>Quick Setup</i> sheet	Initial setup instructions that came with the printer.
Printed <i>Getting Started</i> guide	Additional setup instructions that came with the printer. Note: Not all products come with printed publications.
Electronic <i>User's Guide</i>	Complete instructions for using the printer. The electronic version installs automatically with the printer software.

Customer support

Description	Where to find (North America)	Where to find (rest of world)
Telephone support	<p>Call us at</p> <ul style="list-style-type: none">• US: 1-800-332-4120<ul style="list-style-type: none">– Monday–Friday (8:00 AM–11:00 PM EST), Saturday (Noon–6:00 PM EST)• Canada: 1-800-539-6275<ul style="list-style-type: none">– Support in English: Monday–Friday (8:00 AM–11:00 PM EST), Saturday (Noon–6:00 PM EST)– Support in French: Monday–Friday (9:00 AM–7:00 PM EST)• Mexico: 01-800-253-9627<ul style="list-style-type: none">– Monday–Friday (8:00 AM–8:00 PM EST) <p>Note: Support numbers and times may change without notice. For the most recent telephone numbers available, see the printed warranty statement that came with your printer.</p>	<p>Telephone numbers and support hours vary by country or region.</p> <p>Visit our Web site at www.lexmark.com. Select a country or region, and then select the Customer Support link.</p> <p>Note: For additional information about contacting Lexmark, see the printed warranty that came with your printer.</p>

Description	Where to find (North America)	Where to find (rest of world)
E-mail support	<p>For e-mail support, visit our Web site: www.lexmark.com.</p> <ol style="list-style-type: none"> 1 Click CUSTOMER SUPPORT. 2 Click Technical Support. 3 Select your printer family. 4 Select your printer model. 5 From the Support Tools section, click e-Mail Support. 6 Complete the form, and then click Submit Request. 	<p>E-mail support varies by country or region, and may not be available in some instances.</p> <p>Visit our Web site at www.lexmark.com. Select a country or region, and then select the Customer Support link.</p> <p>Note: For additional information about contacting Lexmark, see the printed warranty that came with your printer.</p>

Limited Warranty

Description	Where to find (USA)	Where to find (rest of world)
<p>Limited Warranty Information</p> <p>Lexmark International, Inc. furnishes a limited warranty that this printer will be free of defects in materials and workmanship for a period of 12 months after the original date of purchase.</p>	<p>To view the limitations and conditions of this limited warranty, see the Statement of Limited Warranty included with this printer, or set forth at www.lexmark.com.</p> <ol style="list-style-type: none"> 1 Click CUSTOMER SUPPORT. 2 Click Warranty Information. 3 From the Statement of Limited Warranty section, click Inkjet & All-In-One Printers. 4 Scroll through the Web page to view the warranty. 	<p>Warranty information varies by country or region. See the printed warranty that came with your printer.</p>

Record the following information (located on the store receipt and the back of the printer), and have it ready when you contact customer support so that they may serve you faster:

- Machine Type number
- Serial number
- Date purchased
- Store where purchased





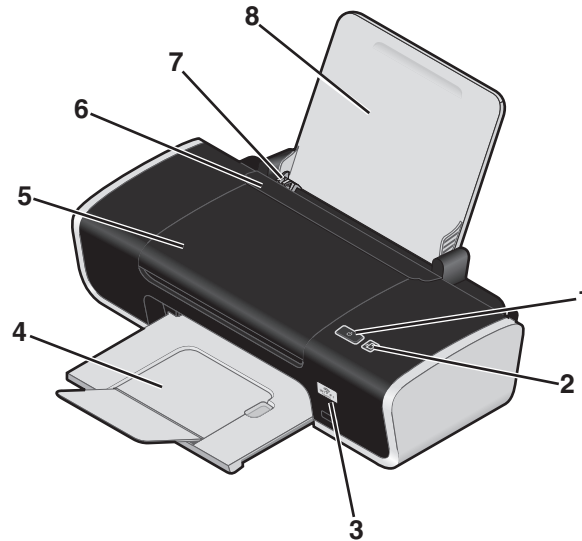

Understanding the printer

Bypassing security warnings during software installation

Third-party applications, including antivirus, security, and firewall programs may alert you about the printer software being installed. For your printer to work properly, allow the printer software to be installed on your computer.



Understanding the parts of the printer

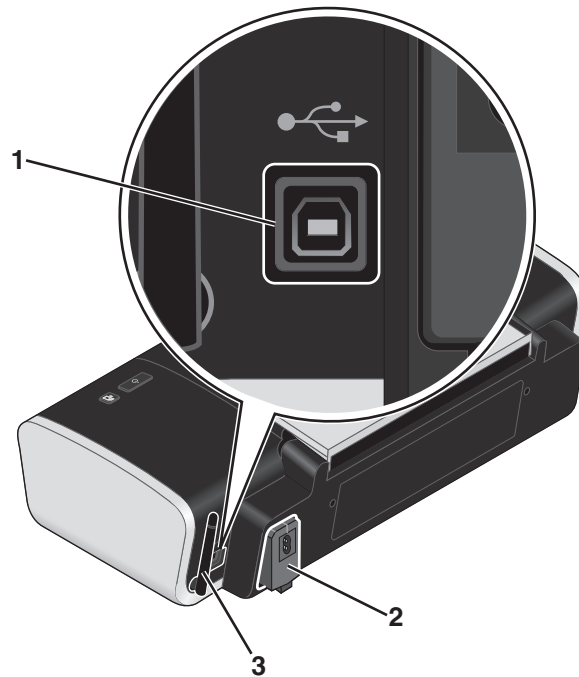

	Use the	To
1		<ul style="list-style-type: none"> • Turn the printer on and off. <ul style="list-style-type: none"> – If the printer is inactive for 30 minutes, then the printer reverts to sleep mode to conserve energy. Press  or start a print job to turn the printer back on. – When the printer is in sleep mode, pressing and holding  for two seconds will turn off the printer. • Cancel a print job. Press  in the middle of a print job. • Be alerted for errors.
2		<ul style="list-style-type: none"> • Load or eject paper. • Cancel a print job. Press  in the middle of a print job.
3	Wi-Fi indicator	Check wireless status: <ul style="list-style-type: none"> • Off—Indicates that no wireless option is available in the printer. • Orange—Indicates that the printer is ready for wireless connection but it is not connected • Orange blinking—Indicates that the printer is configured but unable to communicate with the wireless network • Green—Indicates that the printer is connected to a wireless network
4	Paper exit tray	Hold paper as it exits.

	Use the	To
5	Access cover	<ul style="list-style-type: none"> • Install or change the print cartridges. • Clear paper jams.
6	Paper feed guard	Prevent items from falling into the paper slot.
7	Paper guides	Keep paper straight when feeding.
8	Paper support	Load paper.

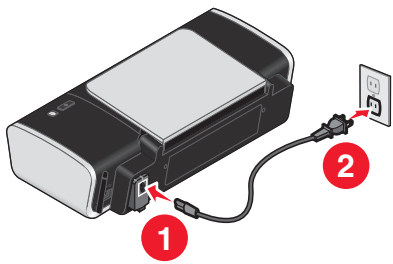

	Use the	To
1	USB port	<p>Connect the printer to a computer using a USB cable.</p> <p>Warning: Do not touch the USB port except when plugging in or removing a USB cable or installation cable.</p>
2	Power supply	<p>Connect the printer to a power source using the power cord.</p> <ol style="list-style-type: none"> 1 Plug the power cord all the way into the power supply on the printer. 2 Plug the power cord into an electrical outlet that other electrical devices have been using.  <p>3 If the  light is not on, press .</p>

	Use the	To
3	Internal wireless adapter	Connect to a wireless network.

Understanding the printer software

Installing printer software

Using Windows

- 1 Close all open software programs.
- 2 Insert the printer software CD.
- 3 From the main installation screen, click **Install**.
- 4 Follow the instructions on the screens.

Using Macintosh

- 1 Close all open software applications.
- 2 Insert the printer software CD.
- 3 From the Finder desktop, double-click the printer CD icon that automatically appears.
- 4 Double-click the **Install** icon.
- 5 Follow the instructions on the screens.

Using the World Wide Web

- 1 Go to the Lexmark Web site at **www.lexmark.com**.
- 2 From the home page, navigate through the menu selection, and then click **Drivers & Downloads**.
- 3 Choose the printer and the printer driver for your operating system.
- 4 Follow the instructions on the screens to download the driver and install the printer software.

Installing the optional XPS driver (Windows Vista users only)

The XML Paper Specification (XPS) driver is an optional printer driver designed to make use of the advanced XPS color and graphics features that are available only for Windows Vista users. To use XPS features, you must install the XPS driver as an additional driver after you install the regular printer software.

Notes:

- Before installing the XPS driver, you must install the printer on your computer.
- Before installing the XPS driver, you must install the Microsoft QFE Patch and then extract the driver files from the installation software CD. To install the patch, you must have administrator privileges on the computer.

To install the Microsoft QFE Patch and extract the driver:

- 1 Insert the installation software CD, and then click **Cancel** when the Setup Wizard appears.
- 2 Click  → **Computer**.

3 Double-click the CD or DVD drive icon, and then double-click **Drivers**.

4 Double-click **xps**, and then double-click the **setupxps** file.

XPS driver files are copied to your computer, and any required Microsoft XPS files are launched. Follow the instructions on the screen to finish installing the patch.

To install the XPS driver:

1 Click  → **Control Panel**.

2 Under Hardware and Sound, click **Printer**, and then click **Add a Printer**.

3 From the Add Printer dialog, click **Add a local printer**.

4 From the "Use an existing port" drop-down menu, select **Virtual printer port for USB**, and then click **Next**.

5 Click **Have disk**.

The Install From Disk dialog appears.

6 Click **Browse**, and then navigate to the XPS driver files on your computer:

a Click **Computer**, and then double-click **(C:)**.

b Double-click **Drivers**, and then double-click **Printer**.

c Double-click the folder that has your printer model number, and then double-click **Drivers**.

d Double-click **xps**, and then click **Open**.

e From the **Install From Disk** dialog, click **OK**.

7 Click **Next** on the two additional dialogs that appear.

For more information on the XPS driver, see the XPS **readme** file on the installation software CD. The file is located in the xps folder with the setupxps batch file (D:\Drivers\xps\readme).

Using the Windows printer software

When you set up the printer using the printer software CD, all the necessary software was installed. You may have chosen to install some additional programs. The following table provides an overview of various software programs and what they can help you do.

Note: Not all of these programs are available on all printers. For example, if you purchased a printer that does not scan or fax items, then the printer software will not support these functions.

Use the	To
Lexmark™ Productivity Studio or Lexmark FastPics	<ul style="list-style-type: none">• Scan, copy, fax, e-mail, or print a photo or document.• Transfer photos.• Make photo greeting cards.• Adjust settings for the printer.
Lexmark Fax Solutions Software	<ul style="list-style-type: none">• Send a fax.• Receive a fax• Add, edit, or delete contacts in the built-in phone book.• Access the Lexmark Fax Setup Utility. Use the Lexmark Fax Setup Utility to set the Speed Dial and Group Dial numbers, set Ringing and Answering, and print fax history and status reports.

Use the	To
Printing Preferences	<p>When you select File → Print with a document open, a Printing Preferences dialog appears. The dialog lets you select options for the print job such as the following:</p> <ul style="list-style-type: none"> • Select the number of copies to be printed. • Print two-sided copies. • Select the paper type. • Add a watermark. • Enhance images. • Save settings.
Lexmark Wireless Setup Utility	<ul style="list-style-type: none"> • Set up the wireless printer on a wireless network. • Change the wireless settings of the printer.

Using the Macintosh printer software

Use the	To
Print dialog	Adjust the print settings and schedule print jobs.
Printer Services dialog	<ul style="list-style-type: none"> • Access the printer utility. • Troubleshoot. • Order ink or supplies. • Contact Lexmark. • Check the printer software version installed on the computer.

Applications are also installed with the printer software during installation. These applications are saved in the printer folder that appears on the Finder desktop after installation.

- 1 From the Finder desktop, double-click the printer folder.
- 2 Double-click the icon of the application that you want to use.

Use the	To
Lexmark All-In-One Center	<ul style="list-style-type: none"> • Scan photos and documents. • Customize settings for scan jobs.
Lexmark Fax Setup Utility	<ul style="list-style-type: none"> • Customize settings for fax jobs. • Create and edit the Speed Dial list.
Lexmark Network Card Reader	<ul style="list-style-type: none"> • View the contents of a memory device inserted into a network printer. • Transfer photos and documents from a memory device to the computer over a network.

Use the	To
Lexmark Printer Utility	<ul style="list-style-type: none"> • Get help with cartridge installation. • Print a test page. • Print an alignment page. • Clean the print cartridge nozzles. • Order ink or supplies. • Register the printer. • Contact customer support.
Lexmark Wireless Setup Assistant	Set up the printer on a wireless network.

Note: Your printer may not come with these applications, depending on the features of the printer that you purchased.

Installing the printer on a wireless network

Wireless network compatibility

Your printer contains an IEEE 802.11g wireless print server. Your printer is compatible with IEEE 802.11 b/g/n routers that are Wi-Fi certified. If you are having issues with an n router, verify with your router manufacturer that the current mode setting is compatible with g devices, as this setting varies depending on the router brand/model.

Information you will need to set up the printer on a wireless network

To set up the printer for wireless printing, you need to know:

- The name of your wireless network. This is also known as the Service Set Identifier (SSID).
- If encryption was used to secure your network.
- The security key (either a WEP key or WPA passphrase) that allows other devices to communicate on the network if encryption was used to secure your network.

If your wireless access point (wireless router) is using Wired Equivalent Privacy (WEP) security, the WEP key should be:

- Exactly 10 or 26 hexadecimal characters. Hexadecimal characters are A–F, a–f, and 0–9.
or
- Exactly 5 or 13 ASCII characters. ASCII characters are letters, numbers, punctuation, and symbols found on a keyboard.

If your wireless access point (wireless router) is using Wi-Fi Protected Access (WPA) security, the WPA passphrase should be:

- From 8 to 63 ASCII characters. ASCII characters in a WPA passphrase are case-sensitive.
or
- Exactly 64 hexadecimal characters. Hexadecimal characters are A-F, a-f, and 0-9.

If your wireless network is not using security, then you will not have a security key. Using a wireless network with no security is not recommended because it can allow intruders to use your network resources without your consent.

Note: Make sure you copy down the security key and SSID exactly, including any capital letters, and store it in a safe place for future reference. Use the table provided below to write down this information.

Item	Description
SSID (name of your wireless network)	
Security key (WEP key or WPA passphrase)	

Note: If you do not know the SSID of the network that your computer is connected to, launch the wireless utility of the computer network adapter and look for the network name. If you cannot find the SSID or the security information for your network, see the documentation that came with the wireless access point (wireless router), or contact the person who set up your wireless network.

Installing the printer on a wireless network

Before you install the printer on a wireless network, make sure that:

- You have completed the initial setup of the printer.
- Your wireless network is set up and working properly.
- The computer you are using is connected to the same wireless network where you want to set up the printer.

Using Windows

1 Insert the installation software CD.

2 Wait a minute for the Welcome screen to appear.

If the Welcome screen does not appear after a minute, do one of the following:

In Windows Vista:

- a** Click .
- b** Locate the Start Search box.
- c** Type `D:\setup.exe`, where **D** is the letter of your CD or DVD drive.

In Windows XP:

- a** Click **Start → Run**.
- b** Type `D:\setup.exe`, where **D** is the letter of your CD or DVD drive.

3 Follow the instructions on the Welcome screen to set up the printer.

Using Macintosh

1 Insert the installation software CD.

2 Wait a minute for the Welcome screen to appear.

Note: If the Welcome screen does not appear after a minute, click the CD icon on the desktop.

3 Double-click **Install**.

4 Follow the instructions on the Welcome screen to set up the printer.

Interpreting the colors of the Wi-Fi indicator light

The Wi-Fi indicator light helps you determine the network status of the printer.

The following describes what the colors of the Wi-Fi indicator light mean.

- **Off** may indicate that the printer is off, the printer is in the initial power-up state, the internal print server is not installed, or the internal print server is not properly connected.

The light should be in this state:

- When the printer is turned off
- When the printer is in power saver mode
- When the printer does not have an internal print server installed and you want to connect the printer to the computer using a USB cable

- **Orange** may indicate that the printer is being configured for use on the wireless network, the internal print server is not configured in infrastructure mode, or the internal print server is waiting to be configured for ad hoc mode.

The light should be in this state:

- When you want to use the printer without a computer
- When you want to set up the printer on your wireless network
- When the printer is set up for an ad hoc network and is broadcasting its wireless network name (SSID)
- **Blinking orange** may indicate that:
 - The printer is out of the range of the wireless access point (wireless router).
 - The printer is trying to communicate with the wireless access point (wireless router), but the wireless access point (wireless router) may be turned off or not working properly.
 - The printer is trying to establish communication with the wireless access point (wireless router).
This is true if you have already configured the printer for use on your wireless network. When the printer has been configured, any time you turn the printer off and then turn it back on, the internal print server in the printer will try to connect to your wireless access point (wireless router).
 - The wireless settings of the printer may no longer be valid.
- **Green** indicates that the printer is connected to a wireless network.
The light should be in this state when you want to start using the printer that is already set up on your wireless network.
- **Blinking green** indicates that the printer internal print server is being updated.

Configuring an IP address manually

The printer will be assigned an IP address automatically through DHCP on most wireless networks.

You must select to manually assign an IP address to the printer in the following situations:

- You manually assigned IP addresses for the other network devices.
- You want to assign a specific IP address.
- You move the printer to a remote subnet.

For more information, contact the person who set up your network.

Changing wireless settings after installation

To change wireless settings on the printer, such as the configured network, the security key, or other settings:

Using Windows

1 Do one of the following:

- In Windows Vista, click .
- In Windows XP, click **Start**.

2 Click **Programs** or **All Programs**, and then select the printer program folder from the list.

3 Click **Tools** → **Lexmark Wireless Setup Utility**.

Note: If the cable is not already connected, you may be prompted to connect the printer to the computer again using the installation cable as part of the setup process.

4 Follow the prompts on the computer screen to reinstall the software, and then make the changes that you want.

Using Macintosh

- 1 From the Finder desktop, double-click the printer folder.
- 2 Double-click **Lexmark Wireless Setup Assistant**.
- 3 Follow the instructions on the computer screen.

Installing the printer on other computers

Once the printer is configured, it can be accessed wirelessly by any other computer on the network. However, you will need to install the printer driver on every computer that will access it. You do not need to configure the printer again, although you will need to run the wireless setup on each computer to install the driver.

Using Windows

- 1 Insert the installation software CD.
- 2 Wait for the Welcome screen to appear.
If the Welcome screen does not appear after a minute, do one of the following:
In Windows Vista:
 - a Click .
 - b Locate the Start Search box.
 - c Type `D:\setup.exe`, where **D** is the letter of your CD or DVD drive.In Windows XP:
 - a Click **Start → Run**.
 - b Type `D:\setup.exe`, where **D** is the letter of your CD or DVD drive.
- 3 Follow the on screen instructions for installing a configured printer on a new computer.

Using Macintosh

- 1 Insert the installation software CD.
- 2 Wait for the Welcome screen to appear.
Note: If the Welcome screen does not appear after a minute, click the CD icon on the desktop.
- 3 Double-click **Install**.
- 4 Follow the on screen instructions for installing a configured printer on a new computer.

Advanced wireless setup

Creating an ad hoc wireless network

The recommended way to set up your wireless network is to use a wireless access point (wireless router). A network set up this way is called an *infrastructure network*. If you have an infrastructure network in your home, you should configure your printer for use on that network.

If you do not have a wireless access point or would like to set up a standalone network between your printer and a computer with a wireless network adapter, then you can set up an ad hoc network.

In Windows Vista

- 1 Click .
- 2 Click **Control Panel**.
- 3 Click **Network and Internet**.
- 4 Under Network and Sharing Center, click **Connect to a Network**.
- 5 In the Connect to a Network dialog, click **Set up a wireless ad-hoc (computer-to-computer) network**, and then click **Next**.
- 6 Follow the instructions in the "Set up a wireless ad hoc network" wizard. As part of the setup:
 - a Create a network name or SSID for the network between the computer and your printer.
 - b Write the name of your network in the space provided so you can refer to it when running the wireless setup. Make sure you copy the exact spelling and capitalization.

SSID (name of your wireless network)	
--------------------------------------	--

- c Go to the Security Type drop-down list, choose **WEP**, and then create a security key (or password).

WEP keys must be:

- Exactly 10 or 26 hexadecimal characters. Hexadecimal characters are A–F, a–f, and 0–9.
or
- Exactly 5 or 13 ASCII characters. ASCII characters are letters, numbers, punctuation, and symbols found on a keyboard.

Note: Security is optional for ad hoc networks. The range of an ad hoc network is much less than the range of an infrastructure network, making it less likely that intruders will connect to it without your knowledge.

- d Write the password for your network in the space provided so you can refer to it when running the wireless setup. Make sure you copy the exact spelling and capitalization.

Security key (if network is secure)	
-------------------------------------	--

Windows Vista will enable the ad hoc network for you. It will appear in the "Connect to a network" dialog under "Available networks," indicating that the computer is configured for the ad hoc network.

- 7 Close the Control Panel and any remaining windows.
- 8 If this is the first time you will be setting up the printer for use on a wireless network, insert the installation software CD, and then follow the instructions on the Welcome screen.

Otherwise:

a Click .

b Click **All Programs**.

c Select the printer program folder, and then click **Tools → Lexmark Wireless Setup Utility**.

- 9** When the available networks are displayed, provide the network name and the security information you created. The installer will configure the printer for use with your computer.
- 10** Store a copy of your network name and security information in a safe place for future reference.

In Windows XP and earlier

- 1** Click **Start**.
- 2** Click **Control Panel**.
- 3** Click **Network and Internet Connections**.
- 4** Click **Network Connections**.
- 5** Right-click the icon for your wireless network connection.
- 6** Click **Enable**, if it appears in the pop-up menu.
- Note:** If Enable does not appear, your wireless connection is already enabled.
- 7** Right-click the **Wireless Network Connection** icon.
- 8** Click **Properties**.
- 9** Click the **Wireless Networks** tab.
- Note:** If the Wireless Networks tab does not appear, your computer has third-party software that controls your wireless settings. You must use that software to set up the ad hoc wireless network. For more information, see the documentation for the third-party software to learn how to create an ad hoc network.
- 10** Select the **Use Windows to configure my wireless network settings** check box.
- 11** Under Preferred Networks, delete any existing networks.
- a** Select the network to be removed.
- b** Click **Remove** to delete the network from the list.
- 12** Click **Add** to create an ad hoc network.
- 13** In the Network Name (SSID) box, type the name you want to give your wireless network.
- 14** Write down the network name you chose so you can refer to it when running the wireless setup. Make sure you copy the exact spelling and capitalization.

SSID (name of your wireless network)	
--------------------------------------	--

- 15** If Network Authentication appears in the list, then select **Open**.
- 16** In the "Data encryption" list, select **WEP**.
- Note:** Security is optional for ad hoc networks. The range of an ad hoc network is much less than the range of an infrastructure network, making it less likely that intruders will connect to it without your knowledge.
- 17** If necessary, clear the "The key is provided for me automatically" check box.

- 18 In the Network Key box, type in a security key.
- 19 Write down the security key you chose so you can refer to it when running the wireless utility. Make sure you copy the exact spelling and capitalization.

Security key (if network is secure)	
-------------------------------------	--

Note: For more information about passwords (security keys), see “Check your security keys” in the “Wireless troubleshooting” section of the Troubleshooting chapter.

- 20 In the “Confirm network key” box, type the same security key.
- 21 Select **This is a computer-to-computer (ad hoc) network; wireless access points are not used..**
- 22 Click **OK** twice to close the two open windows.
- 23 It may take a few minutes for your computer to recognize the new settings. To check on the status of your network:
 - a Right-click the **Wireless Network Connections** icon.
 - b Select **View Available Wireless Networks**.
 - If the network is listed but the computer is not connected, select the ad hoc network and then click **Connect**.
 - If the network does not appear, wait a minute and then click **Refresh network list**.
- 24 If this is the first time you will be setting up the printer for use on a wireless network, insert the installation software CD, and then follow the instructions on the Welcome screen.

Otherwise:

 - a Click **Start**.
 - b Click **All Programs** or **Programs**.
 - c Select the printer program folder from the list, and then click **Tools → Lexmark Wireless Setup Utility**.
- 25 When the available networks are displayed, provide the network name and the security information you created in steps 11-16. The utility will configure the printer for use with your computer.
- 26 Store a copy of your network name and security information in a safe place for future reference.

Using Macintosh

- 1 Make sure the computer is on.
- 2 Create a network name.

For Mac OS X version 10.5

- a From the Finder desktop, click  → **System Preferences**.
- b Click **Network**.
- c Click **AirPort**.
- d From the Network Name pop-up menu, click **Create Network**.
- e Create a name for your ad hoc network, and then click **OK**.

For Mac OS X version 10.4 and earlier

- a From the Finder desktop, click **Go → Applications**.
- b From the Applications folder, double-click **Internet Connect**.

- c** From the toolbar, click **AirPort**.
 - d** From the Network pop-up menu, click **Create Network**.
 - e** Create a name for your ad hoc network, and then click **OK**.
- 3** Write down the network name you chose so you can refer to it when running the wireless utility. Make sure you copy the exact spelling and capitalization.

SSID (name of your wireless network)	
--------------------------------------	--

- 4** If this is the first time you will be setting up the printer for use on a wireless network, insert the installation software CD, double-click the installer icon for your printer on the Finder desktop, and then follow the instructions on the Welcome screen.
- Otherwise, from the Finder desktop, double-click the printer folder, and then double-click **Lexmark Wireless Setup Assistant**.
- 5** When prompted, provide the network name and/or the security information you created.
- The utility will configure the printer for use with your computer.
- 6** Store a copy of your network name and security information in a safe place for future reference.

Adding a printer to an existing ad hoc wireless network

Using Windows

- 1** Do one of the following:
 - In Windows Vista, click .
 - In Windows XP, click **Start**.
- 2** Click **Programs** or **All Programs**, and then select the printer program folder from the list.
- 3** Click **Tools** → **Lexmark Wireless Configuration Utility**.
- 4** Follow the instructions on the Welcome screen.

Using Macintosh

- 1** From the Finder desktop, double-click the printer folder.
- 2** Double-click **Lexmark Wireless Setup Assistant**.
- 3** Follow the instructions on the Welcome screen.

Frequently asked questions

What is a network?

A network is a collection of devices such as computers, printers, Ethernet hubs, wireless access points, and routers connected together for communication through cables or through a wireless connection. A network can be wired, wireless, or designed to have both wired and wireless devices.

Devices on a wired network use cables to communicate with each other.

Devices on a wireless network use radio waves instead of cables to communicate with each other. For a device to be able to communicate wirelessly, it must have a wireless print server attached or installed that lets it receive and transmit radio waves.

How are home networks configured?

For desktop computers, laptops, and printers to communicate with each other over a network, they must be connected by cables and/or have wireless network adapters built in or installed in them.

There are different ways a network can be set up. Five common examples appear below.

Note: The printers in the following diagrams represent printers with internal print servers built in to them so that they can communicate over a network.

Wired network example

- A desktop computer, a laptop, and a printer are connected by Ethernet cables to a hub, router, or switch.
- The network is connected to the Internet through a DSL or a cable modem.

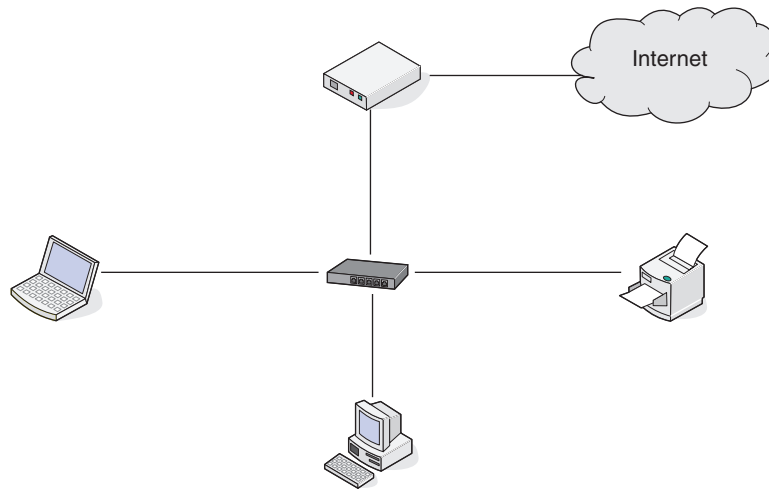

Wireless network examples

Four common wireless networks are:

- Scenario 1: Laptop and printer connected wirelessly with Internet
- Scenario 2: Desktop computer, laptop, and printer connected wirelessly with Internet
- Scenario 3: Desktop computer, laptop, and printer connected wirelessly without Internet
- Scenario 4: Laptop connected wirelessly to printer without Internet

Scenario 1: Laptop and printer connected wirelessly with Internet

- A desktop computer is connected to a wireless router by an Ethernet cable.
- A laptop and a printer are connected wirelessly to the router.

- The network is connected to the Internet through a DSL or a cable modem.

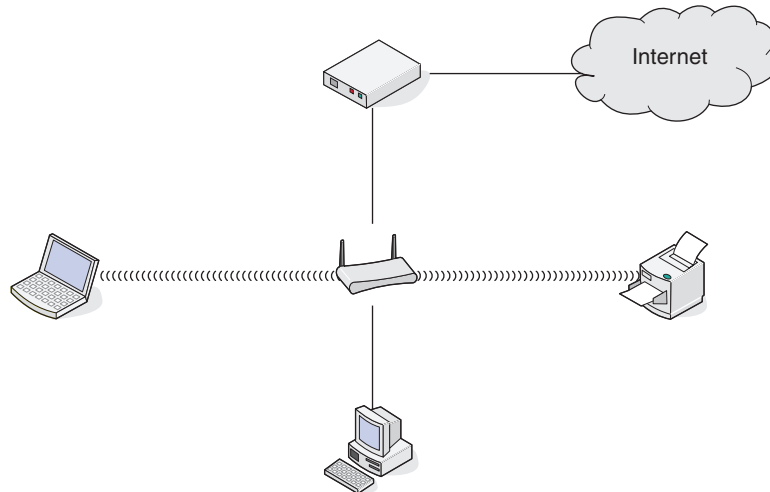

Scenario 2: Desktop computer, laptop, and printer connected wirelessly with Internet

- A desktop computer, a laptop, and a printer are connected wirelessly to a wireless router.
- The network is connected to the Internet through a DSL or a cable modem.

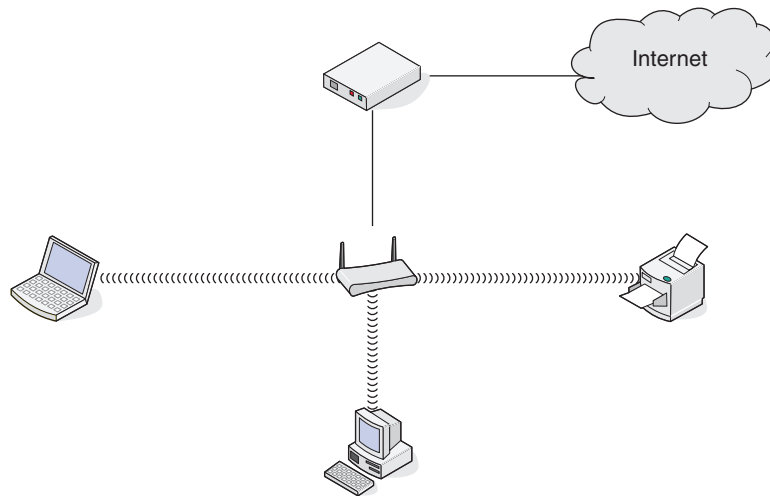

Scenario 3: Desktop computer, laptop, and printer connected wirelessly without Internet

- A desktop computer, a laptop, and a printer are connected wirelessly to a wireless access point (wireless router).
- The network has no connection to the Internet.

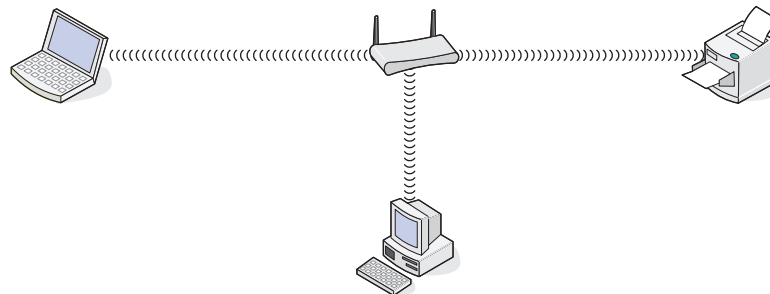

Scenario 4: Laptop connected wirelessly to printer without Internet

- A laptop is directly connected wirelessly to a printer without going through a wireless router.
- The network has no connection to the Internet.

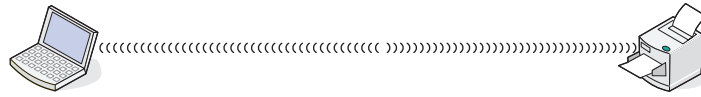

- This configuration is referred to as an ad hoc network.

Why do I need an installation cable?

When setting up the printer on your wireless network, the printer will need to temporarily connect to a computer using the installation cable. This temporary connection is used to set up the wireless settings of the printer.

The installation cable connects to a rectangular USB port on the installing computer and the square USB port on the printer.

How do I attach the installation cable?

The installation cable attaches to a USB port on the computer and to the square connector on the back of the printer. This connection allows you to configure the printer for a networked or locally-attached installation.

- 1 Attach the large, rectangular connector to any USB port on your computer. USB ports may be on the front or the back of the computer, and may be horizontal or vertical.

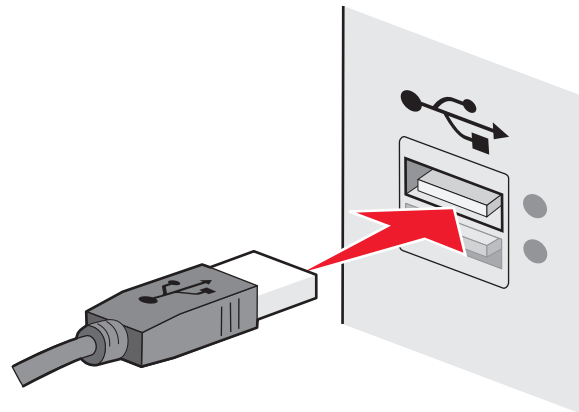

- 2 Attach the small, square connector to the printer.

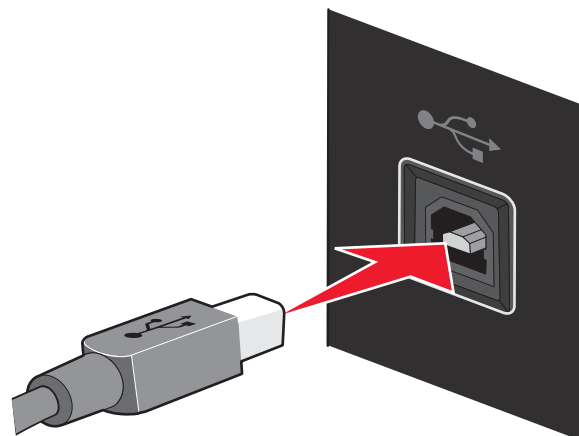

3 Continue following the on-screen instructions.

What is the difference between infrastructure and ad hoc networks?

Wireless networks can operate in one of two modes: infrastructure or ad hoc.

In infrastructure mode, all devices on a wireless network communicate with each other through a wireless router. Devices on the wireless network must have valid IP addresses for the current network and share the same SSID and channel as the wireless router (wireless access point).

In ad hoc mode, a computer with a wireless network adapter communicates directly with a printer equipped with a wireless print server. The computer must have a valid IP address for the current network and be set to ad hoc mode. The wireless print server must be configured to use the same SSID and channel that the computer is using.

The following table compares the characteristics and requirements of the two types of wireless networks.

	Infrastructure	Ad hoc
Characteristics		
Communication	Through wireless access point (wireless router)	Directly between devices
Security	More security options	
Range	Determined by range and number of wireless access points (wireless routers)	Restricted to range of individual devices on network
Speed	Usually faster	Usually slower
Requirements for all devices		
Unique IP address for each device	Yes	Yes
Mode set to	Infrastructure mode	Ad hoc mode
Same SSID	Yes, including the wireless access point (wireless router)	Yes
Same channel	Yes, including the wireless access point (wireless router)	Yes

Lexmark recommends setting up a network in infrastructure mode using the installation CD that came with the printer.

Infrastructure mode is the recommended setup method because it has:

- Increased network security
- Increased reliability
- Faster performance
- Easier setup

Finding the signal strength

Wireless devices have built-in antennas that transmit and receive radio signals. The signal strength listed on the printer network setup page indicates how strongly a transmitted signal is being received. Many factors can affect the signal strength. One factor is interference from other wireless devices or other devices such as microwave ovens. Another factor is distance. The farther two wireless devices are from each other, the more likely it is that the communication signal will be weaker.

The strength of the signal received by your computer can also affect the connectivity of the printer with the network during configuration. When you installed the wireless adapter in your computer, the adapter software probably placed an icon in your system tray. Try double-clicking this icon, and it will tell you how strongly the computer is receiving the wireless signal from the network.

To improve signal quality, remove sources of interference and/or move wireless devices closer to the wireless access point (wireless router).

What is an SSID?

A *Service Set Identifier* (SSID) is the name that identifies a wireless network. All devices on the network must know the SSID of the wireless network or they will not be able to communicate with each other. Usually, the wireless network broadcasts the SSID to allow wireless devices in the area to connect to it. Sometimes, the SSID is not broadcast for security reasons.

An SSID can contain up to 32 alphanumeric characters.

How do I find out what type of security my network is using?

You must know the security key and security mode to properly set up the printer for use on the wireless network. To obtain this information, see the documentation that came with your wireless access point (wireless router), see the Web page associated with the wireless access point (wireless router), or consult your system support person.

Note: The network security key is not the same as the password for the wireless access point (wireless router). The password allows you to access the wireless access point (wireless router) settings. The security key is a WEP key or WPA passphrase that allows printers and computers to join your wireless network.

Can I use my printer on a USB and a wireless connection at the same time?

The printer can be configured in the following ways:

- Locally-attached (connected to a computer using a USB cable)
- Wireless network
- Wireless network and locally-attached simultaneously

If you want to use the printer as both a wireless and locally-attached printer at the same time, you will need to run the setup software again and select the additional connection type.

What is a MAC address?

A *MAC address*, or *Media Access Control address*, is a 48-bit identifier associated with the hardware of network equipment. The MAC address may also be called the physical address because it is connected to the hardware of a device instead of its software. The MAC address is displayed as a hexadecimal number in this format: 01-23-45-67-89-AB.

Every device capable of communicating on a network has a MAC address. Network printers, computers, and routers, whether Ethernet or wireless, all have MAC addresses.

While it is possible to change the MAC address of a network device, it is not common practice to do so. For this reason, MAC addresses are considered permanent. IP addresses are easily changed, so MAC addresses are a more reliable method of identifying a specific device on a network.

Routers with security capabilities may allow filtering of MAC addresses on networks. This allows a managed list of devices to access the network, identified by their MAC addresses. MAC address filtering can help prevent access on the network from unwanted devices, such as from intruders on a wireless network. MAC address filtering can also prevent legitimate access if you forget to add a new device to the router's list of allowed addresses. If your network uses MAC address filtering, be sure to add the MAC address of the printer to the list of allowed devices.

How do I find the MAC address?

Most network equipment has a unique hardware identification number to distinguish it from other devices on the network. This is called the *Media Access Control* (MAC) address.

The MAC address is a series of letters and numbers located on the back of your printer.

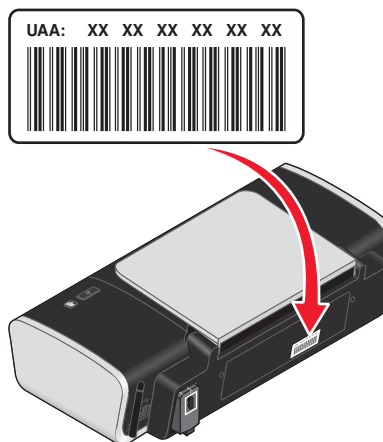

Note: A list of MAC addresses can be set on an access point (router) so that only devices with matching MAC addresses are allowed to operate on the network. This is called MAC filtering. If MAC filtering is enabled in your access point (router) and you want to add a printer to your network, the MAC address of the printer must be included in the MAC filter list.

What is an IP address?

An IP address is a unique number used by devices (such as a wireless printer, computer, or wireless access point) on an IP network to locate and communicate with each other. Devices on an IP network can communicate with each other only if they have unique and valid IP addresses. A unique IP address means no two devices on the same network have the same IP address.

An IP address is a group of four numbers separated by periods. An example of an IP address is 192.168.100.110.

How do I locate IP addresses?

How to locate a computer IP address using Windows

- 1 Do one of the following:

In Windows Vista

- a Click .
- b Click **All Programs → Accessories**.
- c Click **Command Prompt**.

In Windows XP and earlier

- a Click **Start**.
- b Click **All Programs** or **Programs → Accessories → Command Prompt**.

2 Type `ipconfig`.

3 Press **Enter**.

The IP address appears as four sets of numbers separated by periods, such as 192.168.0.100.

How to locate a computer IP address using Macintosh

- 1 Click  → **System Preferences**.
- 2 Click **Network**.

For Mac OS X version 10.5

- a Click **AirPort**.
- b Click **Advanced**.
- c Click **TCP/IP**.

The IP address appears as four sets of numbers separated by periods, such as 192.168.0.100.

For Mac OS X version 10.4 and earlier

- a From the Show pop-up menu, select **AirPort**.
- b Click **TCP/IP**.

The IP address appears as four sets of numbers separated by periods, such as 192.168.0.100.

How to locate a printer IP address

- You can locate the printer IP address by viewing the printer network setup page.

How are IP addresses assigned?

An IP address may be assigned by the network using DHCP. Once the printer is set up on a computer, the computer sends all print jobs across the network to the printer using this address.

Many networks have the ability to automatically assign IP addresses. Auto-IP allows individual devices to assign themselves a unique IP address. However, DHCP is the most commonly-used method to assign addresses.

If the IP address is not automatically assigned, you can try manually entering an address after selecting your printer from the available list.

What is a key index?

A wireless access point (wireless router) can be configured with as many as four WEP keys. Only one key is used on the network at a time, however. The keys are numbered, and the number of a key is referred to as its key index. All devices on the wireless network must be configured to use the same key index when multiple WEP keys are configured on the wireless access point (wireless router).

The printer is designed to use the first key. Make sure you have configured all of the wireless devices on your network to use the first WEP key where you have the option of selecting a key. Make sure the wireless access point (wireless router) is also configured to use the first key. The first key will usually have an index of 0, though it may be 1 on some devices.

Loading paper

Loading paper

- 1 Make sure:
 - You use paper designed for inkjet printers.
 - The paper is not used or damaged.
 - If you are using specialty paper, you follow the instructions that came with it.
 - You do not force paper into the printer.
- 2 Load the paper vertically against the right side of the paper support.
- 3 Adjust the paper guide until it rests against the left edge of the paper.

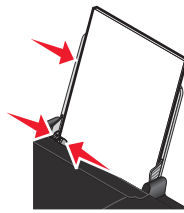

Note: To avoid paper jams, make sure the paper does not buckle when you adjust the paper guide.

Loading various paper types

Load up to	Make sure
100 sheets of plain paper (depending on the thickness)	<ul style="list-style-type: none">• The paper is designed for use with inkjet printers.• The paper is loaded against the right side of the paper support.• The paper guide rests against the left edge of the paper.
25 sheets of heavyweight matte paper 25 sheets of glossy paper 25 sheets of photo paper	<ul style="list-style-type: none">• The stack of heavyweight matte paper does not exceed 10 mm or 1 cm in height.• The glossy or printable side of the paper faces you. (If you are not sure which side is the printable side, see the instructions that came with the paper.)• The paper is loaded against the right side of the paper support.• The paper guide rests against the left edge of the paper. <p>Note: Photos require more drying time. Remove each photo as it exits, and allow it to dry to avoid ink smudging.</p>
10 iron-on transfers	<ul style="list-style-type: none">• You follow the loading instructions that came with the iron-on transfers.• The print side of the transfers faces you.• The transfers are loaded against the right side of the paper support.• The paper guide rests against the left edge of the transfers. <p>Note: For best results, load transfers one at a time.</p>

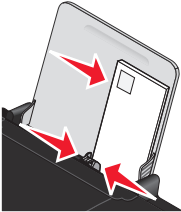
Load up to	Make sure
25 greeting cards 25 index cards 25 photo cards 25 postcards	<ul style="list-style-type: none"> • The total thickness of the card stack does not exceed 10 mm (0.4 inches). • The print side of the cards faces you. • The cards are loaded against the right side of the paper support. • The paper guide rests against the left edge of the cards.
10 envelopes	<ul style="list-style-type: none"> • The stamp location is in the upper left corner. • The print side of the envelopes faces you. • The envelopes are designed for use with inkjet printers. • The envelopes are loaded against the right side of the paper support. • The paper guide rests against the left edge of the envelopes. <p>Warning—Potential Damage: Do not use envelopes that have metal clasps, string ties, or metal folding bars.</p> <p>Notes:</p> <ul style="list-style-type: none"> – Do not load envelopes with holes, perforations, cutouts, or deep embossing. – Do not use envelopes that have exposed flap adhesive. 
25 sheets of labels	<ul style="list-style-type: none"> • You follow the loading instructions that came with the labels. • The print side of the labels faces you. • The adhesive on the labels does not extend to within 1 mm of the edge of the label sheet. • You use full label sheets. Partial sheets (with areas exposed by missing labels) may cause labels to peel off during printing, resulting in a paper jam. • The label sheets are loaded against the right side of the paper support. • The paper guide rests against the left edge of the label sheets.
25 transparencies	<ul style="list-style-type: none"> • The rough side of the transparencies faces you. • You don't use transparencies with paper backing sheets. • The transparencies are loaded against the right side of the paper support. • The paper guide rests against the left edge of the transparencies. <p>Note: Transparencies require more drying time. Remove each transparency as it exits, and allow it to dry to avoid ink smudging.</p>

Printing

Printing basic documents

Printing a document

- 1 Load the paper.

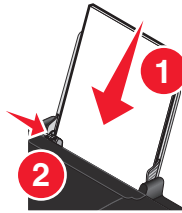

- 2 Do one of the following to print:

Using Windows

- a With a document open in a Windows program, click **File → Print**.
- b Click **Properties, Preferences, Options, or Setup**.
- c Select the print quality, the number of copies to print, the type of paper to be used, and how the pages should print.
- d Click **OK** to close any printer software dialogs.
- e Click **OK** or **Print**.

Using Macintosh

- a With a document open in a Macintosh application, click **File → Print**.
- b From the Printer pop-up menu, choose the printer.
- c From the print options pop-up menu, choose the print quality, the number of copies to print, the type of paper to be used, and how the pages should print.
- d Click **Print**.

Printing Web pages

If you chose to install the Lexmark Toolbar software for your Web browser, then you can use it to create a printer-friendly version of any Web page.

Notes:

- For Windows, the software supports Microsoft Internet Explorer 5.5 or later or a compatible version of Firefox.
- For Macintosh, the software supports a compatible version of Firefox.



- 1 Load paper.
- 2 Open a Web page using a supported browser.
- 3 Select a print option to print the page.
You can also adjust settings or preview the page before printing.

Printing multiple copies of a document

Using Windows

- 1 With a document open, click **File → Print**.
- 2 Click **Properties, Preferences, Options, or Setup**.
- 3 From the Copies section of the Print Setup tab, enter the number of copies that you want to print.
- 4 Click **OK** to close any printer software dialogs.
- 5 Click **OK** or **Print**.

Using Macintosh

- 1 With a document open, click **File → Print**.
- 2 From the Printer pop-up menu, choose the printer.
- 3 In the Copies field, enter the number of copies that you want to print.
- 4 Click **Print**.

Collating printed copies

If you print multiple copies of a document, you can choose to print each copy as a set (collated) or to print the copies as groups of pages (not collated).

Collated



Not collated



Using Windows

- 1 With a document open, click **File → Print**.
- 2 Click **Properties, Preferences, Options, or Setup**.
- 3 From the Copies section of the Print Setup tab, enter the number of copies that you want to print, and then select **Collate Copies**.
- 4 Click **OK** to close any printer software dialogs.
- 5 Click **OK** or **Print**.

Note: The collate option is available only when you are printing multiple copies.

Using Macintosh

- 1 With a document open, click **File → Print**.
- 2 In the Copies field, enter the number of copies that you want to print, and then select **Collated**.
- 3 Click **Print**.

Note: To prevent smudging when printing photos, remove each photo as it exits the printer, and then let it dry before stacking.

Printing the last page first (reverse page order)

Using Windows

- 1 With a document open, click **File → Print**.
- 2 Click **Properties, Preferences, Options, or Setup**.
- 3 From the Copies section of the Print Setup tab, select **Print Last Page First**.
- 4 Click **OK** to close any printer software dialogs.
- 5 Click **OK** or **Print**.

Using Macintosh

- 1 With a document open, click **File → Print**.
- 2 From the Printer pop-up menu, choose the printer.
- 3 Do one of the following:

For Mac OS X version 10.5

- a From the print options pop-up menu, choose **Layout**.
- b Select **Reverse Page Orientation**.

For Mac OS X version 10.4

- a From the print options pop-up menu, choose **Paper Handling**.
- b From the Page Order menu, select **Reverse**.

For Mac OS X version 10.3

- a From the print options pop-up menu, choose **Paper Handling**.
- b Select **Reverse page order**.

- 4 Click **Print**.

Printing multiple pages on one sheet (N-Up)

Using Windows

- 1 With a document open, click **File → Print**.
- 2 Click **Properties, Preferences, Options, or Setup**.

- 3** From the **Advanced** tab, select **N-Up** under the Layout drop-down menu.
- 4** Select the number of page images to print on each page.
If you want each page image to be surrounded by a border, then select **Print Page Borders**.
- 5** Click **OK** to close any printer software dialogs.
- 6** Click **OK** or **Print**.

Using Macintosh

- 1** With a document open, click **File → Print**.
- 2** From the print options pop-up menu, choose **Layout**.
 - From the Pages per Sheet pop-up menu, choose the number of page images that you want to print on one sheet.
 - From the Layout Direction area, click the icon that shows the order that you want the page images to print on one sheet.
 - If you want to print a border around each page image, then choose an option from the Border pop-up menu.
- 3** Click **Print**.

Pausing print jobs

Using the printer folder in Windows

- 1** Do one of the following:

In Windows Vista

- a** Click .
- b** Click **Control Panel**.
- c** Under **Hardware and Sound**, click **Printer**.

In Windows XP

- a** Click **Start**.
- b** Click **Printers and Faxes**.

In Windows 2000

- a** Click **Start**.
- b** Click **Settings → Printers**.

- 2** Right-click the printer, and then select **Pause Printing**.

Using the taskbar in Windows

- 1** Double-click the printer icon in the taskbar.
- 2** Right-click the document name, and then select **Pause**.

Using Macintosh

- 1 While the document is printing, click the printer icon in the Dock.
The print queue dialog appears.
- 2 Do one of the following:
 - If you want to pause a particular print job, choose the document name, and then click **Hold**.
 - If you want to pause all print jobs in the queue, click **Pause Printer** or **Stop Jobs**, depending on the operating system version that you are using.

Canceling print jobs

Using Windows

- 1 Do one of the following to open the printer folder:
 - In Windows Vista, click  → **Control Panel** → **Printer**.
 - In Windows XP, click **Start** → **Printers and Faxes**.
- 2 Right-click the printer name, and then select **Open**.
- 3 Right-click the document name, and then select **Cancel**.

Using Macintosh

- 1 While the document is printing, click the printer icon on the dock.
- 2 From the queue window, select the job that you want to cancel.
- 3 Click the **Delete** icon.

Printing specialty documents

Printing envelopes

- 1 Load the envelopes in the printer.

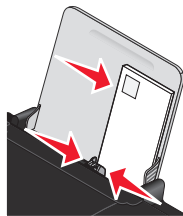

- 2 Do one of the following:

Using Windows

- a With a document open, click **File** → **Print**.
- b Click **Properties**, **Preferences**, **Options**, or **Setup**.
- c From the Media Type list of the Print Setup tab, select **Plain**.

d From the Paper Size list, select the envelope size.

Note: To print on a custom-size envelope, select **Custom Size**, and then specify the height and width of the envelope.

e Select **Portrait** or **Landscape** orientation.

f Click **OK** to close any printer software dialogs.

g Click **OK** or **Print**.

Using Macintosh

a Customize the settings as needed in the Page Setup dialog.

1 With a document open, click **File → Page Setup**.

2 From the "Format for" pop-up menu, choose the envelope size. If no size matches the size of the envelope, then set a custom size.

3 Select an orientation.

4 Click **OK**.

b Customize the settings as needed in the Print dialog.

1 With a document open, click **File → Print**.

2 From the Printer pop-up menu, choose the printer that you want to use.

3 Click **Print**.

Notes:

- Most envelopes use landscape orientation.
- Make sure the same orientation is also selected in the software application.

Printing labels

1 Load the label sheets in the printer.

2 Do one of the following:

Using Windows

a With a document open, click **File → Print**.

b Click **Properties**, **Preferences**, **Options**, or **Setup**.

c From the Paper Size drop-down menu of the Print Setup tab, choose a paper size that matches the size of the label sheet. If no paper size matches the label sheet size, then set a custom size.

If necessary, choose the appropriate type of media from the Media Type drop-down menu.

d Click **OK** to close any printer software dialogs.

e Click **OK** or **Print**.

Using Macintosh

a Customize the settings as needed in the Page Setup dialog.

1 With a document open, choose **File → Page Setup**.

2 From the "Format for" pop-up menu, choose the printer that you want to use.

3 From the Paper Size pop-up menu, choose a paper size that matches the size of the label sheet. If no paper size matches the label sheet size, then create a custom size.

- b** Customize the settings as needed in the Print dialog.
 - 1** With a document open, click **File → Print**.
 - 2** From the Printer pop-up menu, choose the printer that you want to use.
 - 3** From the print options pop-up menu, choose **Quality & Media**.
 - 4** From the Paper type pop-up menu, choose a paper type.
 - 5** From the Print Quality menu, choose a print quality other than Quick Print.

Tips on loading label sheets

- Make sure the top of the label sheet feeds into the printer first.
- Make sure the adhesive on the labels does not extend to within 1 mm of the edge of the label sheet.
- Make sure the paper guide or paper guides rest against the edges of the label sheet.
- Use full label sheets. Partial sheets (with areas exposed by missing labels) may cause labels to peel off during printing, resulting in a paper jam.

Note: Labels require more drying time. Remove each label sheet as it exits, and then allow it to dry to avoid ink smudging.

Printing on custom-size paper

Before beginning these instructions, load the custom-size paper in the printer. For more information, see the “Loading Paper” chapter.

Using Windows

- 1** With a document open, click **File → Print**.
- 2** Click **Properties, Preferences, Options, or Setup**.
The Print Setup tab appears.
- 3** In the Paper Options section, from the “Paper size” list, select **Custom Size**.
The Define Custom Paper Size dialog appears.
- 4** Select the measurement units to use (inches or millimeters).
- 5** Click **OK** to close any printer software dialogs that are open.
- 6** Print the document.

Using Macintosh

- 1** With a document open, click **File → Page Setup**.
- 2** From the Paper size pop-up menu, choose **Manage Custom Sizes**.
- 3** Create a custom size.
 - a** Click **+**.
 - b** In the Page Size menu, type the Width and Height of the paper.
 - c** From the Printer Margins pop-up menu, choose the printer that you want to use. The margins are set by the printer.
If you want to set the margins, choose **User defined**, and then type the margins in the Printer Margins area.

- d From the custom sizes list on the left of the dialog, double-click **Untitled**, and then type a name for the custom paper size you set.
 - e Click **OK**.
- 4 Open the Paper size pop-up menu again, and then choose the name of the custom paper size you added in Step 3d.
- 5 Click **Print**.

Printing other specialty documents

When you installed the printer driver, some printer software was installed that may help you print specialty documents such as booklets, posters, iron-on transfers, transparencies, and banners. For information about printing these documents, see the Help installed with the programs or applications you choose to use.

Using Windows

- 1 Do one of the following:
 - In Windows Vista, click  → **All Programs**, and then select the printer program folder from the list.
 - In Windows XP, click **Start** → **Programs or All Programs**, and then select the printer program folder from the list.
- 2 Click the program that you want to use.

Using Macintosh

- 1 From the Finder desktop, double-click the printer folder.

If the printer folder is not found on the desktop:

 - a Go to the Mac OS X drive where the printer software was installed.
 - b Choose **Library** → **Printers** → **YYYY** → **Lexmark**, and then select your printer model.
YYYY is the year that the printer was released.
- 2 Double-click the application that you want to use.

Saving and deleting print settings

Using Windows

- 1 With a document open, click **File** → **Print**.
- 2 Click **Properties**, **Preferences**, **Options**, or **Setup**.
- 3 Make adjustments to the settings.
- 4 Click **Profiles**, and then click **Save your current settings**.
- 5 Select an empty location for your setting, and then assign a name.

Note: The first location contains Factory Default Settings, which cannot be changed or deleted.
- 6 Click **Save**.
- 7 Close all open software dialogs.

Notes:

- To retrieve your print settings, click **Profiles → Restore a Profile**, and then select the name of the profile that you want to use.
- To delete a setting, click **Profiles → Delete Profiles**. Select the setting that you want to delete, and then click **Delete**.

Using Macintosh

The Presets pop-up menu lets you save the print settings you use often. When print settings are saved into a Preset, there is no need to adjust the print settings for every print job.

- 1** With a document open, click **File → Print**.
- 2** From the print options pop-up menu, choose and adjust the settings.
- 3** From the Presets pop-up menu, choose **Save As**.
The Save Preset dialog appears.
- 4** Type a name for the Preset.
- 5** Click **OK**.

Working with photos

Using recommended paper

For best results when printing photos or other high-quality images, use Lexmark Photo Paper or Lexmark PerfectFinish™ Photo Paper.

Printing photos

Printing photos from a CD or removable storage device connected to the computer

Using Windows

- 1 Load photo paper with the glossy or printable side facing you. (If you are not sure which side is the printable side, see the instructions that came with the paper.)
- 2 Insert a CD or any removable storage device (such as a flash drive, memory card, or digital camera) into the computer.
If you install Lexmark FastPics or Lexmark Productivity Studio, then the software will launch when you insert the flash drive, memory card, or digital camera.
- 3 Follow the instructions on the computer screen to print photos.
- 4 Remove the CD or storage device.

Using Macintosh

- 1 Load photo paper with the glossy or printable side facing you. (If you are not sure which side is the printable side, see the instructions that came with the paper.)
- 2 Insert a CD or any removable storage device (such as a flash drive, memory card, or digital camera) into the computer.
- 3 Customize the settings as needed in the Page Setup dialog.
 - a With a photo open, choose **File → Page Setup**.
 - b From the "Format for" pop-up menu, choose your printer series.
 - c From the Paper Size pop-up menu, choose the paper size loaded.
 - d Choose an orientation.
 - e Click **OK**.
- 4 Customize the settings as needed in the Print dialog.
 - a With a photo open, choose **File → Print**.
 - b From the "Format for" pop-up menu, choose your printer series.
 - c For Mac OS X version 10.4 or later, click **Advanced**. Otherwise, proceed to the next step.
 - d From the Copies & Pages pop-up menu, type the number of copies to be printed.

e From the same pop-up menu, choose **Quality & Media**.

- From the Paper Type pop-up menu, choose the type of paper you are using.
- From the Print Quality area, choose **Automatic** or **Photo**.

f Click **Print**.

5 Remove the CD or storage device.

Maintaining the printer

Maintaining print cartridges

Installing print cartridges

- 1 Open the access cover, and then press down on the cartridge carrier levers.

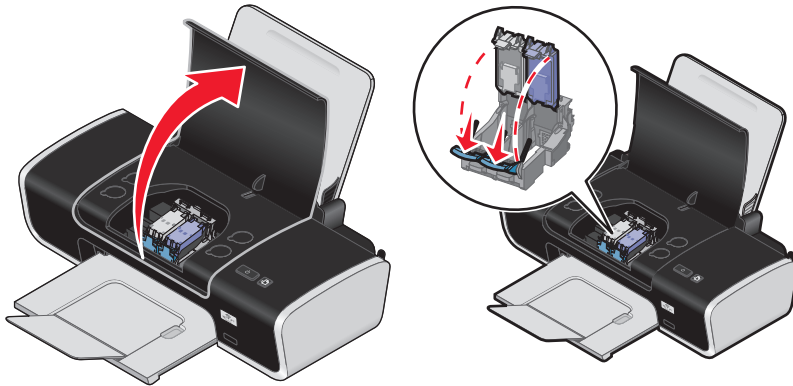

- 2 Remove the used print cartridge or cartridges.
- 3 If you are installing new print cartridges, remove the tape from the back and bottom of the black cartridge, insert the cartridge in the left carrier, and then close the black cartridge carrier lid.

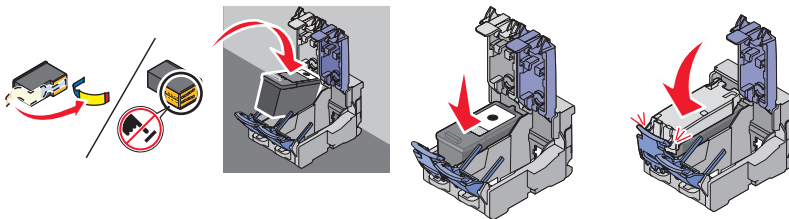

Warning—Potential Damage: Do *not* touch the gold contact area on the back or the metal nozzles on the bottom of the cartridge.

- 4 Remove the tape from the back and bottom of the color cartridge, insert the cartridge in the right carrier, and then close the color cartridge carrier lid.

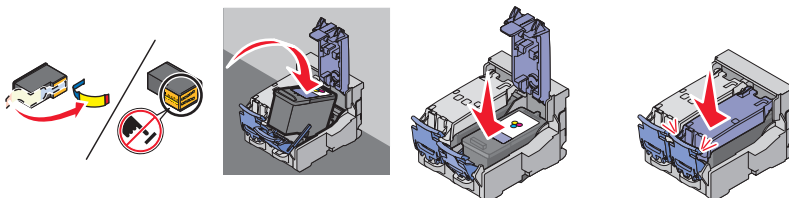

Warning—Potential Damage: Do *not* touch the gold contact area on the back or the metal nozzles on the bottom of the cartridge.

- 5 Close the access cover.

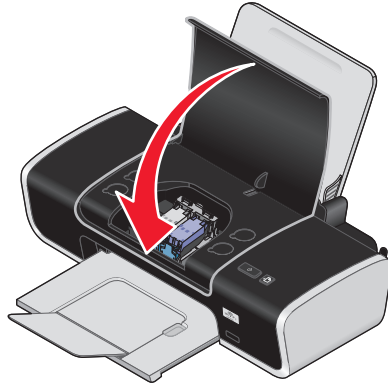

Note: The printer must be closed to start a new print job.

Removing used print cartridges

- 1 Make sure the printer is on.
- 2 Lift the access cover, and then press down on the cartridge carrier latch to raise the cartridge carrier lid. The print cartridge carrier moves and stops at the loading position, unless the printer is busy.

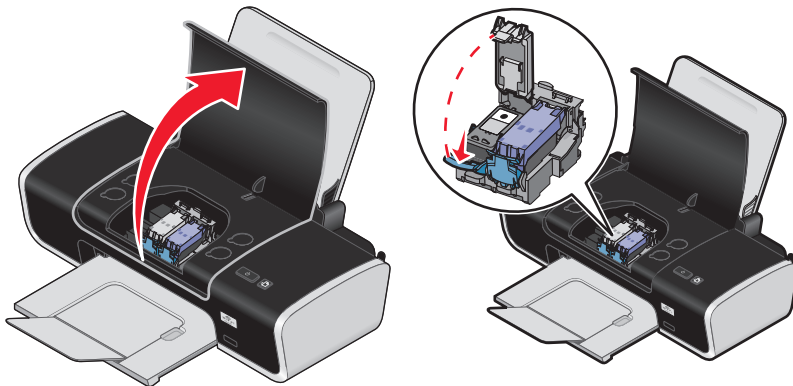

- 3 Remove the used print cartridge.

Refilling print cartridges

The warranty does not cover repair of failures or damage caused by a refilled cartridge. Lexmark does not recommend use of a refilled cartridge. Refilling a cartridge can affect print quality and may cause damage to the printer. For best results, use Lexmark supplies.

Using genuine Lexmark print cartridges

Lexmark printers, print cartridges, and photo paper are designed to perform together for superior print quality.

If you receive an **Out of Original Lexmark Ink** message, the original Lexmark ink in the indicated cartridge (s) has been depleted.

If you believe you purchased a new, genuine Lexmark print cartridge, but the **Out of Original Lexmark Ink** message appears:

- 1 Click **Learn More** on the message.
- 2 Click **Report a non-Lexmark print cartridge**.

To prevent the message from appearing again for the indicated cartridge(s):

- Replace your cartridge(s) with new Lexmark print cartridge(s).
- If you are printing from a computer, click **Learn more** on the message, select the check box, and then click **Close**.
- If you are using the printer without a computer, press **Cancel**.

Lexmark's warranty does not cover damage caused by non-Lexmark ink or print cartridges.

Aligning the print cartridges

Using Windows

- 1 Load plain paper.
- 2 Click **Start → Programs** or **All Programs**, and then click the printer folder.
- 3 From the printer folder, click **Maintenance → Align cartridges**.
- 4 Click **Print**.
- 5 Follow the instructions on the computer screen.
- 6 If you aligned the cartridges to improve print quality, print your document again. If print quality has not improved, clean the print cartridge nozzles.

Using Macintosh

- 1 Load plain paper.
- 2 From the Finder desktop, double-click the printer folder.
- 3 Double-click the printer utility icon.
- 4 From the Maintenance tab, click **Print Alignment Page**.
- 5 Follow the instructions on the computer screen.
- 6 If you aligned the cartridges to improve print quality, print your document again. If print quality has not improved, clean the print cartridge nozzles.

Cleaning the print cartridge nozzles

Using Windows

- 1 Load plain paper.
- 2 Click **Start → Programs** or **All Programs**, and then click the printer folder.
- 3 From the printer folder, click **Maintenance → Clean cartridges**.
- 4 Click **Print**.

- 5 Follow the instructions on the computer screen.
- 6 If print quality has not improved, then wipe the print cartridge nozzles and contacts.

Using Macintosh

- 1 Load plain paper.
- 2 From the Finder desktop, double click the printer folder.
- 3 Double-click the printer utility icon.
- 4 From the Maintenance tab, click **Clean Print Nozzles**.
A page prints, forcing ink through the print cartridge nozzles to clean them.
- 5 To test if the print quality has improved, print the document again.
- 6 If print quality has not improved, then try cleaning the nozzles up to two more times.

Wiping the print cartridge nozzles and contacts

- 1 Remove the print cartridge(s).
- 2 Dampen a clean, lint-free cloth with water, and then place the cloth on a flat surface.
- 3 Gently hold the nozzles against the cloth for about three seconds, and then wipe in the direction shown.

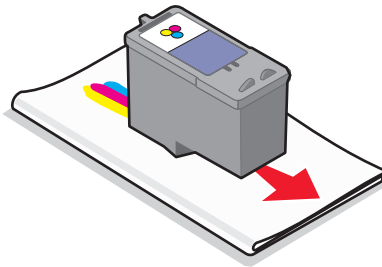

- 4 Using another clean section of the cloth, gently hold the cloth against the contacts for about three seconds, and then wipe in the direction shown.

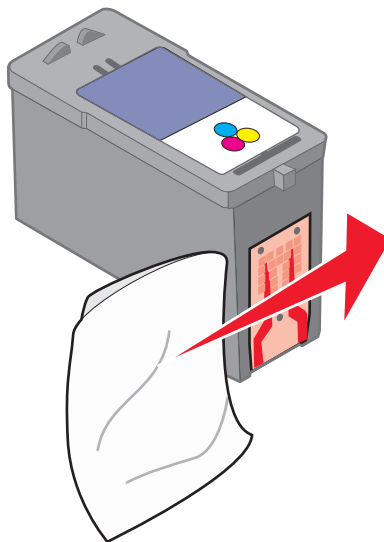

- 5 With another clean section of the cloth, repeat step 3 and step 4, and then let the nozzles and contacts dry completely.
- 6 Reinsert the print cartridge(s), and then print the document again.
- 7 If the print quality does not improve, clean the print nozzles, and then try printing the document again.
- 8 Repeat step 7 up to two more times.
- 9 If print quality is still not satisfactory, replace the print cartridge(s).

Preserving the print cartridges

- Keep new cartridges in their packaging until you are ready to install them.
- Do not remove a cartridge from the printer except to replace, clean, or store it in an airtight container. The cartridges do not print correctly if left exposed for an extended period of time.

Cleaning the exterior of the printer

- 1 Make sure that the printer is turned off and unplugged from the wall outlet.



CAUTION—SHOCK HAZARD: To avoid the risk of electric shock, unplug the power cord from the wall outlet and disconnect all cables to the printer before proceeding.

- 2 Remove paper from the paper support and paper exit tray.
- 3 Dampen a clean, lint-free cloth with water.

Warning—Potential Damage: Do not use household cleaners or detergents, as they may damage the finish of the printer.

- 4 Wipe only the outside of the printer, making sure to remove any ink residue that has accumulated on the paper exit tray.

Warning—Potential Damage: Using a damp cloth to clean the interior may cause damage to your printer.

- 5 Make sure the paper support and paper exit tray are dry before beginning a new print job.

Ordering supplies

Ordering print cartridges

Lexmark Z2400 Series (except Lexmark Z2490)

Item	Part number	Average cartridge standard page yield is up to ¹
Black cartridge	36A	Page yield values available at www.lexmark.com/pageyields .
Black cartridge ²	36	
High yield black cartridge	36XLA	
High yield black cartridge ²	36XL	
Color cartridge	37A	
Color cartridge ²	37	
High yield color cartridge	37XLA	
High yield color cartridge ²	37XL	
Photo cartridge	31	Not applicable
¹ Values obtained by continuous printing. Declared yield value in accordance with ISO/IEC 24711. ² Licensed Return Program Cartridge		

Lexmark Z2490

Item	Part number	Average cartridge standard page yield is up to ¹
Black cartridge	4A	Page yield values available at www.lexmark.com/pageyields .
Black cartridge ²	4	
Color cartridge	5A	
Color Cartridge ²	5	
Photo cartridge	31	Not applicable
¹ Values obtained by continuous printing. Declared yield value in accordance with ISO/IEC 24711. ² Licensed Return Program Cartridge		

Ordering paper and other supplies

To purchase supplies or to locate a dealer near you, visit our Web site at www.lexmark.com.

For best results when printing photos or other high-quality images, use Lexmark Photo Paper or Lexmark PerfectFinish Photo Paper and Lexmark print cartridges.

Item	Description
Lexmark Photo Paper	<ul style="list-style-type: none">• Letter• A4• 4 x 6 in.• 10 x 15 cm
Lexmark PerfectFinish Photo Paper	<ul style="list-style-type: none">• Letter• A4• 4 x 6 in.• 10 x 15 cm• L
USB cable	Part number 1021294

Troubleshooting

Using the printer troubleshooting software (Windows only)

The Lexmark Service Center provides step-by-step troubleshooting help and contains links to printer maintenance tasks and customer support.

To open the Lexmark Service Center, use one of these methods:

Method 1	Method 2
If it appears on an error message dialog, click the For additional assistance, use the Lexmark Service Center link.	<ol style="list-style-type: none">1 Do one of the following:<ul style="list-style-type: none">• In Windows Vista, click  → All Programs, and then select the printer program folder from the list.• In Windows XP, click Start → Programs or All Programs, and then select the printer program folder from the list.2 Select Lexmark Service Center.

Setup troubleshooting

Power button is not lit

These are possible solutions. Try one or more of the following:

PRESS POWER BUTTON

Make sure the printer is on by pressing .

DISCONNECT AND RECONNECT THE POWER CORD

- 1 Press  to turn the printer off.
- 2 Disconnect the power cord from the wall outlet.
- 3 Remove the power supply from the printer.
- 4 Plug the power cord all the way into the power supply on the printer.

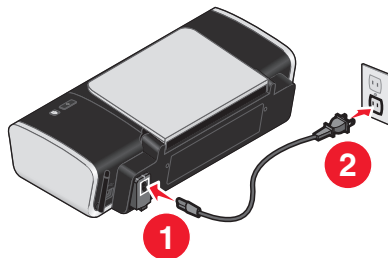

- 5 Plug the power cord into the wall outlet.

- 6 Plug the power cord into an electrical outlet that other electrical devices have been using.
- 7 Press  to turn the printer on.

Software did not install

If you encountered problems while installing, or if your printer does not appear in the list in the Printers folder or as a printer option when sending a print job, you can try uninstalling and reinstalling the software.

These are some other possible solutions. Try one or more of the following:

MAKE SURE YOUR OPERATING SYSTEM IS SUPPORTED

The following operating systems are supported: Windows Vista, Windows XP, Windows 2000 with Service Pack 3 or later, and Mac OS X versions 10.5, 10.4 and 10.3.



CHECK THAT YOUR COMPUTER MEETS THE MINIMUM SYSTEM REQUIREMENTS LISTED ON THE PRINTER BOX

CHECK THE USB CONNECTION

- 1 Check the USB cable for any obvious damage. If the cable is damaged, use a new one.
- 2 Firmly plug the square end of the USB cable into the back of the printer.
- 3 Firmly plug the rectangular end of the USB cable into the USB port of the computer.

The USB port is marked with the  USB symbol.

RECONNECT THE POWER SUPPLY

- 1 Press  to turn the printer off.
- 2 Disconnect the power cord from the wall outlet.
- 3 Gently remove the power supply from the printer.
- 4 Reconnect the power supply to the printer.
- 5 Plug the power cord into the wall outlet.
- 6 Press  to turn the printer on.

TEMPORARILY DISABLE SECURITY PROGRAMS IN WINDOWS

- 1 Close all open programs.
- 2 Disable any security programs.
- 3 Do one of the following:
 - In Windows Vista, click .
 - In Windows XP and earlier, click **Start**.
- 4 Click **Computer** or **My Computer**.
- 5 Double-click the CD or DVD drive icon.

- 6 If necessary, double-click **setup.exe**.
- 7 Follow the instructions on the computer screen to install the software.
- 8 When the installation is completed, enable the security software again.

Page does not print

These are possible solutions. Try one or more of the following:

CHECK MESSAGES

If an error message appears, then resolve the error before trying to print again.

CHECK POWER

If the  light is not on, then make sure that the power cord is properly connected to the printer and plugged into a known working electrical outlet that other electrical devices have been using.

REMOVE AND THEN RELOAD PAPER

CHECK INK

Check the ink levels, and then install new print cartridges if necessary.

CHECK CARTRIDGES

- 1 Remove the print cartridges.
- 2 Make sure the sticker and tape have been removed.

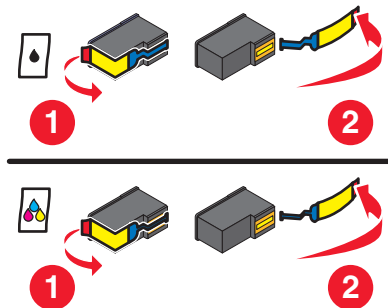

- 3 Reinsert the cartridges.

CHECK PRINTER DEFAULT AND PAUSE SETTINGS

Using Windows

- 1 Do one of the following:

In Windows Vista

- a Click .
- b Click **Control Panel**.

- c Under Hardware and Sound, click **Printer**.

In Windows XP

- a Click **Start**.
- b Click **Printers and Faxes**.

In Windows 2000

- a Click **Start**.
- b Click **Settings → Printers**.

2 Double-click the printer.

3 Click **Printer**.

- Make sure no check mark appears next to Pause Printing.
- If a check mark does not appear next to Set As Default Printer, then you must select the printer for each file that you want to print.

Using Macintosh

For Mac OS X version 10.5

1 From the Finder desktop, click  → **System Preferences → Print & Fax**.

2 From the Default Printer pop-up menu, check if the printer is the default printer.

If the printer is not the default printer, then you must select the printer for each file that you want to print.

If you want to set the printer as the default printer, then select the printer from the Default Printer pop-up menu.

3 Click **Open Print Queue**.

The print queue dialog appears.

Make sure that the print job is not on hold. If the print job is on hold:

- If you want to resume a particular print job, choose the document name, and then click **Resume**.
- If you want to resume all print jobs in the queue, then click **Resume Printer**.

For Mac OS X version 10.4 and earlier

1 From the Finder desktop, click **Go → Utilities → Print Center** or **Printer Setup Utility**.

The Printer List dialog appears.

2 Double-click the printer.

The print queue dialog appears.

- Make sure that the print job is not on hold.

If the print job is on hold:



- If you want to resume a particular print job, choose the document name, and then click **Resume**.
- If you want to resume all print jobs in the queue, then click **Start Jobs**.

- If the printer is not in bold, then it is not the default printer. You must select the printer for each file that you want to print.

If you want to set the printer as the default printer:

- a Go back to the Printer List dialog, and then select the printer.
- b Click **Make Default**.

DISCONNECT AND RECONNECT POWER SUPPLY

- 1 Press  to turn off the printer.
- 2 Disconnect the power cord from the wall outlet.
- 3 Remove the power supply from the printer.
- 4 Reconnect the power supply to the printer.
- 5 Plug the power cord into the wall outlet.
- 6 Press  to turn on the printer.

REMOVE AND REINSTALL THE SOFTWARE



If you encountered problems while installing, or if your printer does not appear in the printers folder or as a printer option when sending a print job, then try uninstalling and reinstalling the software.

Solving printer power problems

The printer and the computer cannot exchange data.

These are possible solutions. Try one or more of the following:

MAKE SURE THE PRINTER POWER SUPPLY IS ATTACHED CORRECTLY

- 1 Press  to turn the printer off.
- 2 Disconnect the power cord from the wall outlet.
- 3 Remove the power supply from the printer.
- 4 Reconnect the power supply to the printer.
- 5 Plug the power cord into the wall outlet.
- 6 Press  to turn the printer on.

MAKE SURE THE PRINTER IS NOT IN SLEEP MODE

If the power light is blinking on and off slowly, then the printer is in sleep mode.

- 1 Unplug the power cord from the wall outlet.
- 2 Wait ten seconds, and then insert the power cord into the wall outlet.
- 3 Press  to turn the printer on.

Removing and reinstalling the software

If the printer is not functioning properly, or if a communications error message appears when you try to use the printer, you may need to remove and reinstall the printer software.

Using Windows

- 1 Do one of the following:
 - In Windows Vista, click .
 - In Windows XP, click **Start**.
- 2 Click **Programs** or **All Programs**, and then select the printer program folder from the list.
- 3 Select **Uninstall**.
- 4 Follow the instructions on the computer screen to remove the printer software.
- 5 Restart the computer before reinstalling the printer software.
- 6 Click **Cancel** on all New Hardware Found screens.
- 7 Insert the installation CD, and then follow the instructions on the computer screen to reinstall the software. If the install screen does not appear automatically after you restart your computer, do one of the following:

In Windows Vista:

- a Click .
- b Locate the Start Search box.
- c Type **D:\setup.exe**, where **D** is the letter of your CD or DVD drive.

In Windows XP:

- a Click **Start** → **Run**.
- b Type **D:\setup.exe**, where **D** is the letter of your CD or DVD drive.

Using Macintosh

- 1 Close all open software applications.
 - 2 From the Finder desktop, double-click the printer folder.
 - 3 Double-click the **Uninstaller** icon.
 - 4 Follow the instructions on the computer screen to remove the printer software.
 - 5 Restart the computer before reinstalling the printer software.
 - 6 Insert the installation CD, and then follow the instructions on the computer screen to reinstall the software.
- If the software still does not install correctly, visit our Web site at **www.lexmark.com** to check for the latest software.
- 1 In all countries or regions except the United States, select your country or region.
 - 2 Click the links for drivers or downloads.
 - 3 Select your printer family.
 - 4 Select your printer model.

- 5 Select your operating system.
- 6 Select the file that you want to download, and then follow the directions on the computer screen.

Enabling the USB port in Windows

To confirm that the USB port is enabled on the computer:

- 1 Do one of the following:

In Windows Vista

- a Click  → **Control Panel**.
- b Click **System and Maintenance** → **System**.
- c Click **Device Manager**.

In Windows XP

- a Click **Start**.
- b Click **Control Panel** → **Performance and Maintenance** → **System**.
- c From the Hardware tab, click **Device Manager**.

In Windows 2000

- a Click **Start**.
- b Click **Settings** → **Control Panel** → **System**.
- c From the Hardware tab, click **Device Manager**.

- 2 Click the plus sign (+) beside **Universal Serial Bus Controller**.







If USB Host Controller and USB Root Hub are listed, then the USB port is enabled.

For more information, see the computer documentation.

Wireless troubleshooting

Printing a network setup page

A *network setup page* lists the configuration settings of your printer, including the IP address and MAC address of the printer.

- 1 Make sure the printer is turned on.
- 2 Press .
- The  light pulses.
- 3 Open the access cover.
- 4 Press and hold .
- 5 While holding , press .
- 6 When the  light becomes steady, release .
- The network setup page prints.

Wireless troubleshooting checklist

Before beginning to troubleshoot the wireless printer, verify the following:

- The power supply is connected to the printer, and  is on.
- Your SSID is correct.
Print a network setup page to verify the SSID the printer is using.
If you are not sure if your SSID is correct, run the wireless setup again.
- Your WEP key or WPA passphrase is correct (if your network is secure).
Log into the wireless access point (wireless router) and check the security settings.
A security key is like a password. All devices on the same wireless network using WEP, WPA-PSK, or WPA2-PSK share the same security key.
If you are not sure if your security information is correct, run the wireless setup again.
- The wireless network is working properly.
Try accessing other computers on your wireless network.
If your network has Internet access, try connecting to the Internet over a wireless connection.
- The printer is within the range of the wireless network.
For most networks, the printer should be within 100 feet (30 meters) of the wireless access point (wireless router).
- The printer is located away from obstacles that could block the wireless signal.
Remove any large metal objects between the access point and the printer.
Make sure the printer and wireless access point are not separated by poles, walls, or support columns containing metal or concrete.
- The printer is located away from other electronic devices that may interfere with the wireless signal.
Many devices can interfere with the wireless signal, including baby monitors, motors, cordless phones, security system cameras, other wireless networks, and some Bluetooth devices.
- The Wi-Fi indicator light is lit.
- The printer driver is installed on the computer from which you are performing a task.
- The correct printer port is selected.
- The computer and printer are both connected to the same wireless network.

Wireless configuration does not continue after the USB cable is attached

Check the USB cable

If the configuration software does not allow you to continue configuring your printer wirelessly after you attach the USB cable, there may be a problem with the cable. Try one or more of the following:

- Make sure that the USB cable is not damaged. If there is any visible damage to the USB cable, try using a new one.
- Attach the cable directly to the computer and the printer. Hubs, switch boxes, and docking stations can sometimes interfere with the USB connection.

- Make sure the USB cable is correctly attached.
 - 1 Attach the large, rectangular connector to any USB port on your computer. USB ports may be on the front or the back of the computer, and may be horizontal or vertical.

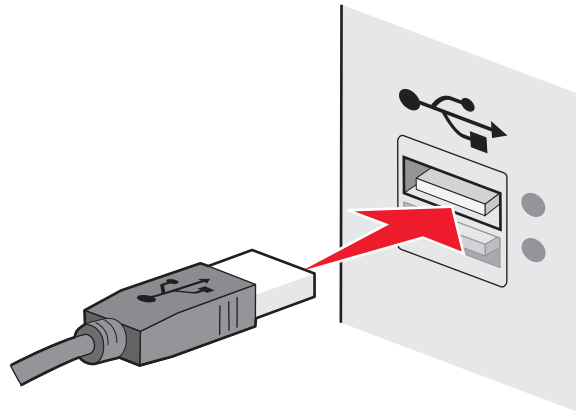

- 2 Attach the small, square connector to the printer.

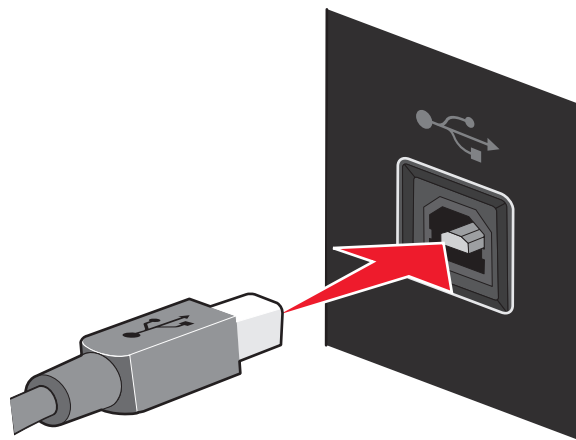

Cannot print over wireless network

If you encountered problems while installing, or if your printer does not appear in the printers folder or as a printer option when sending a print job, you can try uninstalling and reinstalling the software.

These are possible solutions. Try one or more of the following:

MAKE SURE YOUR COMPUTER IS CONNECTED TO YOUR WIRELESS ACCESS POINT (WIRELESS ROUTER)

- See if you have access to the Internet by opening your Web browser and accessing any site.
- If there are other computers or resources on your wireless network, check to see if you can access them from your computer.

MOVE THE COMPUTER AND/OR PRINTER CLOSER TO THE WIRELESS ROUTER

Although the possible distance between devices in 802.11b or 802.11g networks is 300 feet, the maximum range for optimal performance is generally 100–150 feet.

CHECK WHETHER THE PRINTER IS ON THE SAME WIRELESS NETWORK AS THE COMPUTER

The SSID of the printer must match the SSID of the wireless network.

Using Windows

1 Type the IP address of the wireless access point (wireless router) in the Web address field of your browser.

If you do not know the IP address of the wireless access point:

a Do one of the following:

- In Windows Vista, click  → **All Programs** → **Accessories** → **Command Prompt**.
- In Windows XP and earlier, click **Start** → **Programs** or **All Programs** → **Accessories** → **Command Prompt**.

b Type `ipconfig`.

c Press **Enter**.

- The “Default Gateway” entry is typically the wireless access point.
- The IP address appears as four sets of numbers separated by periods, such as 192.168.0.100. Your IP address might also start with the numbers 10 or 169. This is determined by your operating system or wireless network software.

2 Type your user name and password for the wireless access point (wireless router) when prompted.

3 Click **OK**.

4 On the main page, click **Wireless** or another selection where settings are stored. The SSID appears.

5 Write down the SSID, security type, and the security keys if they are shown.

Note: Make sure you copy them down exactly, including any capital letters.

6 Store the SSID and the security keys in a safe place for future reference.

Using Macintosh with an AirPort base station

For Mac OS X version 10.5

1 From the Finder desktop, click  → **System Preferences**.

2 Click **Network**.

3 Click **AirPort**.

The SSID of the network the computer is connected to is displayed in the Network Name pop-up menu.

4 Write down the SSID.

For Mac OS X version 10.4 and earlier

1 From the menu bar, click **Go** → **Applications**.

2 From the Applications folder, double-click **Internet Connect**.

3 From the toolbar, click **AirPort**.

The SSID of the network the computer is connected to is displayed in the Network pop-up menu.

4 Write down the SSID.

Using Macintosh with a wireless access point (wireless router)

- 1 Type the IP address of the wireless access point (wireless router) in the Web address field of your browser and continue to Step 2.

If you do not know the IP address of the wireless access point (wireless router), then do the following:

For Mac OS X version 10.5

- a From the Finder desktop, click  → **System Preferences**.
- b Click **Network**.
- c Click **AirPort**.
- d Click **Advanced**.
- e Click **TCP/IP**.

The "Router" entry is typically the wireless access point (wireless router).

For Mac OS X version 10.4 and earlier

- a From the Finder desktop, click  → **System Preferences**.
- b Click **Network**.
- c From the Show pop-up menu, select **Airport**.
- d Click **TCP/IP**.

The "Router" entry is typically the wireless access point (wireless router).

- 2 Type your user name and password when prompted.
- 3 Click **OK**.
- 4 On the main page, click **Wireless** or another selection where settings are stored. The SSID will be displayed.
- 5 Write down the SSID, security type and the security keys if they are shown.

Notes:

- Make sure you copy them down exactly, including any capital letters.
- Store the SSID and the security keys in a safe place for future reference.

CHECK YOUR SECURITY KEYS

A security key is like a password. All devices on the same wireless network must share the same security key.

WEP key

Must meet one of the following criteria:

- Exactly 10 or 26 hexadecimal characters. Hexadecimal characters are A-F, a-f, and 0-9.
- or*
- Exactly 5 or 13 ASCII characters. ASCII characters are letters, numbers, and symbols found on a keyboard. ASCII characters in a WEP key are case-sensitive.

WPA-PSK or WPA2-PSK passphrase or key

Must meet one of the following criteria:

- From 8 to 63 ASCII characters. ASCII characters in a WPA passphrase are case-sensitive.
or
- Exactly 64 hexadecimal characters. Hexadecimal characters are A-F, a-f, and 0-9.

Note: If you do not know this information, see the documentation that came with the wireless network, or contact the person who set up your wireless network.

CHECK YOUR ADVANCED SECURITY SETTINGS

- If you are using MAC address filtering to limit access to your wireless network, you must add the printer MAC address to the list of addresses allowed to connect to the wireless access point (wireless router).
- If you set the wireless access point (wireless router) to issue a limited number of IP addresses, you must change this so that the printer can be added.

Note: If you do not know how to make these changes, see the documentation that came with the wireless network, or contact the person who set up your wireless network.

Cannot print and there is a firewall on the computer

Third-party (non-Microsoft) firewalls can interfere with wireless printing. If the printer and computer are configured correctly, and the wireless network is working, but the printer will not print wirelessly, a firewall could be the problem. If there is a firewall (other than the Windows firewall) on the computer, try one or more of the following:

- Update the firewall using the most recent update available from the manufacturer. Refer to the documentation that came with your firewall for instructions on how to do this.
- If programs request firewall access when you install the printer or try to print, make sure you allow those programs to run.
- Temporarily disable the firewall and install the wireless printer on the computer. Re-enable the firewall when you have completed the wireless installation.

Wi-Fi indicator light is not lit

CHECK POWER

Make sure the  light is on.

Wi-Fi indicator light is green but the printer does not print (Windows only)

If you have completed the configuration for wireless printing and all of the settings appear to be correct, but the printer does not print, try one or more of the following:

ALLOW THE WIRELESS INSTALLATION TO COMPLETE

Do not attempt to print, remove the installation CD, or detach the installation cable until you see the Wireless Setup Successful screen.

ENABLE THE PRINTER

Confirm that the printer is enabled.

- 1 Do one of the following:

In Windows Vista

- a Click  → **Control Panel**.
- b Under Hardware and Sound, click **Printer**.

In Windows XP

- Click **Start** → **Printers and Faxes**.

- 2 Right-click the new printer. If you see **Use Printer Online** in the menu, select it.
- 3 Close the Printers or Printers and Faxes window and try printing again.

SELECT THE WIRELESS PRINTER

If you have previously set up your printer as a locally-attached printer, you may need to select the wireless printer to use the printer wirelessly.

- 1 Do one of the following:

In Windows Vista

- a Click  → **Control Panel**.
- b Under Hardware and Sound, click **Printer**.

In Windows XP

- Click **Start** → **Printers and Faxes**.

- 2 Check to see if you have a printer called Copy 1 in your folder. If you do, right-click the Copy 1 printer and click **Use Printer Online** from the menu.
- 3 Close the Printers or Printers and Faxes window and try printing again.

SELECT THE WIRELESS PORT

If you have previously set up your printer as a locally-attached printer, you may need to select the wireless printer to use the printer wirelessly.

- 1 Do one of the following:

In Windows Vista

- a Click  → **Control Panel**.
- b Under Hardware and Sound, click **Printer**.

In Windows XP

- Click **Start** → **Printers and Faxes**.

- 2 Right-click the printer and select **Properties** from the menu.
- 3 Click the **Ports** tab.

- 4 Locate the selected port. The selected port has a check in the Port column.
- 5 If the Description column of the selected port indicates that it is a USB port, scroll through the list and select the port with Printer Port in the Description column.
- 6 Click **OK**, and then try to print again.

Wi-Fi indicator light is blinking orange during installation (Windows only)

When the Wi-Fi indicator light is blinking orange, it indicates that the printer has been set up for wireless networking but cannot connect to the network for which it has been configured. The printer may be unable to join the network because of interference, its distance from the wireless access point (wireless router), or until its settings are changed.

These are possible solutions. Try one or more of the following:

MAKE SURE THE WIRELESS ACCESS POINT (WIRELESS ROUTER) IS ON

Check the wireless access point (router) and, if necessary, turn it on.

MOVE YOUR WIRELESS ACCESS POINT (WIRELESS ROUTER) TO MINIMIZE INTERFERENCE

There may be temporary interference from other devices such as microwave ovens or other appliances, cordless phones, baby monitors, and security system cameras. Make sure your wireless access point (wireless router) is not positioned too closely to these devices.

TRY ADJUSTING EXTERNAL ANTENNAS

Antennas usually work best if they are pointing straight up. You may find that reception improves if you experiment with different angles for the printer and/or wireless access point antennas.

MOVE YOUR PRINTER

Move the printer closer to the wireless access point (wireless router). Although the possible distance between devices in 802.11b or 802.11g networks is 300 feet, the maximum range for optimal performance is generally 100–150 feet.

You can find the signal strength of the network on the network setup page.

CHECK SECURITY KEYS

If your wireless access point (wireless router) is using Wired Equivalent Privacy (WEP) security, the WEP key should be:

- Exactly 10 or 26 hexadecimal characters. Hexadecimal characters are A–F, a–f, and 0–9.

or

- Exactly 5 or 13 ASCII characters. ASCII characters are letters, numbers, and symbols found on a keyboard.

If your wireless access point (wireless router) is using Wi-Fi Protected Access (WPA) security, the WPA passphrase should be:

- From 8 to 63 ASCII characters. ASCII characters in a WPA passphrase are case-sensitive.

or



- Exactly 64 hexadecimal characters. Hexadecimal characters are A–F, a–f, and 0–9.

If your wireless network is not using security, then you will not have a security key. Using a wireless network with no security is not recommended because it can allow intruders to use your network resources without your consent.

CHECK MAC ADDRESS

If your network uses MAC address filtering, provide the MAC address for the printer to your network.

PING THE WIRELESS ACCESS POINT (WIRELESS ROUTER) TO MAKE SURE THE NETWORK IS WORKING

- 1 If you do not already know it, find the IP address of the access point (router).
 - a Do one of the following:
 - In Windows Vista, click  → **All Programs** → **Accessories** → **Command Prompt**.
 - In Windows XP, click **Start** → **Programs** or **All Programs** → **Accessories** → **Command Prompt**.
 - b Type `ipconfig`.
 - c Press **Enter**.
 - The “Default Gateway” entry is typically the wireless access point (wireless router).
 - The IP address appears as four sets of numbers separated by periods, such as 192.168.0.100. Your IP address might also start with the numbers 10 or 169. This is determined by your operating system or wireless network software.
- 2 Ping the wireless access point (wireless router).
 - a Do one of the following:
 - In Windows Vista, click  → **All Programs** → **Accessories** → **Command Prompt**.
 - In Windows XP, click **Start** → **Programs** or **All Programs** → **Accessories** → **Command Prompt**.
 - b Type `ping` followed by a space and the IP address of the wireless access point. For example:

```
ping 192.168.0.100
```
 - c Press **Enter**.
- 3 Check to see whether the access point responds:
 - If the wireless access point (wireless router) responds, you will see several lines appear that start with “Reply from.”

It is possible that the printer did not connect to the wireless network. Turn off and then restart the printer to try to connect again.
 - If the wireless access point (wireless router) does not respond, it will take several seconds and then you will see “Request timed out.”

Try the following:

 - a Do one of the following:
 - In Windows Vista, click  → **Control Panel** → **Network and Internet** → **Network and Sharing Center**.
 - In Windows XP, click **Start** → **Control Panel** → **Network Connection**.
 - b Select the appropriate connection from the ones shown.

Note: If the computer is connected to the access point (router) by an Ethernet cable, the connection may not include the word “wireless” in its name.

 - c Right-click the connection, and then click **Repair**.

RUN THE WIRELESS SETUP AGAIN

If your wireless settings have changed, you must run the printer wireless setup again. Some reasons your settings may have changed include your having manually changed your WEP or WPA keys, channel, or other network settings; or the wireless access point (wireless router) having been reset to factory defaults.

Running the wireless setup again can also resolve issues due to misconfigurations that occurred when configuring the printer for wireless access.

Notes:

- If you change network settings, change them on all the network devices before changing them for the wireless access point (wireless router).
 - If you have already changed the wireless network settings on your wireless access point (wireless router), then you must change the settings on all the other network devices before you can see them on the network.
- 1 Do one of the following:
 - In Windows Vista, click .
 - In Windows XP, click **Start**.
 - 2 Click **Programs** or **All Programs**, and then select the printer program folder from the list.
 - 3 Click **Tools** → **Lexmark Wireless Setup Utility**.

Note: You may be prompted to connect the printer to the computer again using the installation cable as part of the setup process.
 - 4 Follow the instructions on the computer screen.

Wi-Fi indicator light is blinking orange during installation (Macintosh only)

When the Wi-Fi indicator light is blinking orange, it indicates that the printer has been set up for wireless networking but cannot connect to the network for which it has been configured. The printer may be unable to join the network because of interference, its distance from the wireless access point (wireless router), or until its settings are changed.

These are possible solutions. Try one or more of the following:

MAKE SURE THE WIRELESS ACCESS POINT IS ON

Check the wireless access point and, if necessary, turn it on.

MOVE YOUR WIRELESS ACCESS POINT TO MINIMIZE INTERFERENCE

There may be temporary interference from other devices such as microwave ovens or other appliances, cordless phones, baby monitors, and security system cameras. Make sure the wireless access point is not positioned too closely to these devices.

TRY ADJUSTING EXTERNAL ANTENNAS

Antennas usually work best if they are pointing straight up. You may find that reception improves if you experiment with different angles for the printer and/or wireless access point antennas.

MOVE YOUR PRINTER

Move the printer closer to the wireless access point. Although the possible distance between devices in 802.11b or 802.11g networks is 300 feet, the effective range for optimal performance is generally 100–150 feet.

You can find the signal strength of the network on the network setup page.

CHECK SECURITY KEYS

If you are using WEP security

A valid WEP key is:

- Exactly 10 or 26 hexadecimal characters. Hexadecimal characters are A–F, a–f, and 0–9.
or
- Exactly 5 or 13 ASCII characters. ASCII characters are letters, numbers, and symbols found on a keyboard.

If you are using WPA security

A valid WPA passphrase is:

- From 8 to 63 ASCII characters. ASCII characters in a WPA passphrase are case-sensitive.
or
- Exactly 64 hexadecimal characters. Hexadecimal characters are A–F, a–f, and 0–9.

If your wireless network is not using security, then you will not have a WEP key or WPA passphrase. Using a wireless network with no security is not recommended because it can allow intruders to use your network resources without your consent.

CHECK THE MAC ADDRESS

If your network uses MAC address filtering, make sure that you include the MAC address of the printer in the MAC address filter list. This will allow the printer to operate on the network.

PING THE ACCESS POINT TO MAKE SURE THE NETWORK IS WORKING

- 1 Check the AirPort status and, if you do not already know it, find the IP address of the wireless access point.

In Mac OS X version 10.5

- a From the menu bar, click  → **System Preferences**.
- b Click **Network**.
- c Click **AirPort**.

Check Status. It should be on. If it is off, click **Turn AirPort On**.

The AirPort status indicator should also be green. Green means the port is active (turned on) and connected.

Notes:

- Yellow means the port is active but is not connected.
- Red means the port has not been configured.

- d Click **Advanced**.

- e Click **TCP/IP**.
 - The IP address appears as four sets of numbers separated by periods, such as 192.168.0.100.
 - The "Router" entry is typically the wireless access point.

In Mac OS X version 10.4 and earlier

- a Click  → **System Preferences**.
- b Click **Network**.
- c If necessary, select **Network Status** in the Show pop-up menu.
The AirPort status indicator should be green. Green means the port is active (turned on) and connected.

Notes:

- Yellow means the port is active but is not connected.
- Red means the port has not been configured.

- d From the Show pop-up menu, select **AirPort**.
 - e Click **TCP/IP**.
 - The IP address appears as four sets of numbers separated by periods, such as 192.168.0.100.
 - The "Router" entry is typically the wireless access point.
- 2 Ping the wireless access point.
- a From the menu bar, click **Go → Utilities**.
 - b Double-click **Network Utility**.
 - c Click the **Ping** tab.
 - d Type the IP address of the wireless access point in the network address field. For example:
`10.168.0.100`
 - e Click **Ping**.
- 3 If the wireless access point responds, you will see several lines that display the number of bytes received from the access point. This ensures that your computer is connected to the access point.
If the wireless access point does not respond, nothing is displayed. You can use Network Diagnostics to help resolve the problem.

RUN THE WIRELESS SETUP AGAIN

- 1 From the Finder desktop, double-click the printer folder.
- 2 Double-click **Lexmark Wireless Setup Assistant**.
- 3 Follow the instructions on the computer screen.

Wi-Fi indicator light is still orange

When the Wi-Fi indicator light is orange, it may indicate that the printer is:

- Being configured for use on the wireless network
- Not configured in infrastructure mode
- Waiting to be configured for ad hoc mode

The printer may be unable to join the network because of interference, its distance from the wireless access point (wireless router), or until its settings are changed.

These are possible solutions. Try one or more of the following:

CHECK NETWORK NAME

Make sure your network does not have the same name as another network near you. For example, if you and your neighbor both use a manufacturer's default network name, your printer could be connecting to your neighbor's network.

If you are not using a unique network name, consult the documentation for your wireless access point (wireless router) to learn how to set a network name.

If you set a new network name, you must reset the printer and computer SSID to the same network name.

CHECK SECURITY KEYS

If your wireless access point (wireless router) is using Wired Equivalent Privacy (WEP) security, the WEP key should be:

- Exactly 10 or 26 hexadecimal characters. Hexadecimal characters are A–F, a–f, and 0–9.

or

- Exactly 5 or 13 ASCII characters. ASCII characters are letters, numbers, and symbols found on a keyboard.

If your wireless access point (wireless router) is using Wi-Fi Protected Access (WPA) security, the WPA passphrase should be:

- From 8 to 63 ASCII characters. ASCII characters in a WPA passphrase are case-sensitive.

or

- Exactly 64 hexadecimal characters. Hexadecimal characters are A–F, a–f, and 0–9.

If your wireless network is not using security, then you will not have a security key. Using a wireless network with no security is not recommended because it can allow intruders to use your network resources without your consent.

MOVE YOUR PRINTER

Move the printer closer to the wireless access point (wireless router). Although the possible distance between devices in 802.11b or 802.11g networks is 300 feet, the maximum range for optimal performance is generally 100-150 feet.

CHECK MAC ADDRESS

If your network uses MAC address filtering, make sure that you include the MAC address of the printer in the MAC address filter list. This will allow the printer to operate on the network. For more information, see "How do I find the MAC address?" on page 29.

Wireless print server not installed

You may see a message during installation indicating that the printer does not have a wireless print server installed. If you are sure the printer is capable of wireless printing, try the following:

CHECK POWER

Make sure the  light is on.

“Communication not available” message displays when printing wirelessly

If you are using a laptop and have power saving settings enabled, you may see the **Communication not available** message on your computer screen when you attempt to print wirelessly. This can occur if the laptop hard drive has powered down.

If you see this message, wait a few seconds and then try to print again. The laptop and printer require a few seconds to power up again and reattach to the wireless network.

If you see this message again after you have waited long enough for the printer and the laptop to attach to the network, there may be a problem with your wireless network. Make sure that the laptop and printer have both received IP addresses. For more information on locating IP addresses, refer to “How do I locate IP addresses?” on page 29.

If the printer and/or the laptop does not have an IP address, or if either has an address of 169.254.x.y (where x and y are any two numbers between 0 and 255):

- 1** Shut down the device that does not have a valid IP address (the laptop, the printer, or both).
- 2** Turn on the device(s).
- 3** Check the IP addresses again.

If the laptop and/or printer still does not receive a valid IP address, there is a problem with your wireless network. Make sure your wireless access point (wireless router) is working, and remove any obstacles that could be blocking the wireless signal.

Notices

Product information

Product name:

Lexmark Z2400 Series

Machine type:

4116

Model(s):

W01

Edition notice

January 2008

The following paragraph does not apply to any country where such provisions are inconsistent with local law: LEXMARK INTERNATIONAL, INC., PROVIDES THIS PUBLICATION "AS IS" WITHOUT WARRANTY OF ANY KIND, EITHER EXPRESS OR IMPLIED, INCLUDING, BUT NOT LIMITED TO, THE IMPLIED WARRANTIES OF MERCHANTABILITY OR FITNESS FOR A PARTICULAR PURPOSE. Some states do not allow disclaimer of express or implied warranties in certain transactions; therefore, this statement may not apply to you.

This publication could include technical inaccuracies or typographical errors. Changes are periodically made to the information herein; these changes will be incorporated in later editions. Improvements or changes in the products or the programs described may be made at any time.

References in this publication to products, programs, or services do not imply that the manufacturer intends to make these available in all countries in which it operates. Any reference to a product, program, or service is not intended to state or imply that only that product, program, or service may be used. Any functionally equivalent product, program, or service that does not infringe any existing intellectual property right may be used instead. Evaluation and verification of operation in conjunction with other products, programs, or services, except those expressly designated by the manufacturer, are the user's responsibility.

For Lexmark technical support, visit **support.lexmark.com**.

For information on supplies and downloads, visit **www.lexmark.com**.

If you don't have access to the Internet, you can contact Lexmark by mail:

Lexmark International, Inc.
Bldg 004-2/CSC
740 New Circle Road NW
Lexington, KY 40550
USA

© 2008 Lexmark International, Inc.

All rights reserved.

UNITED STATES GOVERNMENT RIGHTS

This software and any accompanying documentation provided under this agreement are commercial computer software and documentation developed exclusively at private expense.

Trademarks

Lexmark and Lexmark with diamond design are trademarks of Lexmark International, Inc., registered in the United States and/or other countries.

PerfectFinish is a trademark of Lexmark International, Inc.

All other trademarks are the property of their respective owners.

Licensing notices

The following document can be viewed from the \Drivers\XPS directory on the installation software CD: Zopen.PDF.

Federal Communications Commission (FCC) compliance information statement

This product has been tested and found to comply with the limits for a Class B digital device, pursuant to Part 15 of the FCC Rules. Operation is subject to the following two conditions: (1) this device may not cause harmful interference, and (2) this device must accept any interference received, including interference that may cause undesired operation.

The FCC Class B limits are designed to provide reasonable protection against harmful interference when the equipment is operated in a residential installation. This equipment generates, uses, and can radiate radio frequency energy and, if not installed and used in accordance with the instructions, may cause harmful interference to radio communications. However, there is no guarantee that interference will not occur in a particular installation. If this equipment does cause harmful interference to radio or television reception, which can be determined by turning the equipment off and on, the user is encouraged to try to correct the interference by one or more of the following measures:

- Reorient or relocate the receiving antenna.
- Increase the separation between the equipment and receiver.
- Connect the equipment into an outlet on a circuit different from that to which the receiver is connected.
- Consult your point of purchase or service representative for additional suggestions.

The manufacturer is not responsible for radio or television interference caused by using other than recommended cables or by unauthorized changes or modifications to this equipment. Unauthorized changes or modifications could void the user's authority to operate this equipment.

Note: To assure compliance with FCC regulations on electromagnetic interference for a Class B computing device, use a properly shielded and grounded cable such as Lexmark part number 1021294 for USB attach. Use of a substitute cable not properly shielded and grounded may result in a violation of FCC regulations.

Any questions regarding this compliance information statement should be directed to:

Director of Lexmark Technology & Services
Lexmark International, Inc.
740 West New Circle Road
Lexington, KY 40550
(859) 232-3000

Exposure to radio frequency radiation

The following notice is applicable if your printer has a wireless network card installed.

The radiated output power of this device is far below the radio frequency exposure limits of the FCC and other regulatory agencies. A minimum separation of 20 cm (8 inches) must be maintained between the antenna and any persons for this device to satisfy the RF exposure requirements of the FCC and other regulatory agencies.

Industry Canada compliance statement

This Class B digital apparatus meets all requirements of the Canadian Interference-Causing Equipment Standard ICES-003.

Avis de conformité aux normes de l'industrie du Canada

Cet appareil numérique de classe B est conforme aux exigences de la norme canadienne relative aux équipements pouvant causer des interférences NMB-003.

Industry Canada notice

The following notices are applicable if your printer has a wireless network card installed.

Industry Canada (Canada)

This device complies with Industry Canada specification RSS-210. Operation is subject to the following two conditions: (1) this device may not cause interference, and (2) this device must accept any interference, including interference that may cause undesired operation of the device.

This device has been designed to operate only with the antenna provided. Use of any other antenna is strictly prohibited per regulations of Industry Canada.

To prevent radio interference to the licensed service, this device is intended to be operated indoors and away from windows to provide maximum shielding. Equipment (or its transmit antenna) that is installed outdoors is subject to licensing.

The installer of this radio equipment must ensure that the antenna is located or pointed such that it does not emit RF fields in excess of Health Canada limits for the general population; consult Safety Code 6, obtainable from Health Canada's Web site www.hc-sc.gc.ca/rpb.

The term "IC:" before the certification/registration number only signifies that the Industry Canada technical specifications were met.

Industry Canada (Canada)

Cet appareil est conforme à la norme RSS-210 d'Industry Canada. Son fonctionnement est soumis aux deux conditions suivantes :

(1) cet appareil ne doit pas provoquer d'interférences et (2) il doit accepter toute interférence reçue, y compris celles risquant d'altérer son fonctionnement.

Cet appareil a été conçu pour fonctionner uniquement avec l'antenne fournie. L'utilisation de toute autre antenne est strictement interdite par la réglementation d'Industry Canada.

En application des réglementations d'Industry Canada, l'utilisation d'une antenne de gain supérieur est strictement interdite.

Pour empêcher toute interférence radio au service faisant l'objet d'une licence, cet appareil doit être utilisé à l'intérieur et loin des fenêtres afin de garantir une protection optimale.

Si le matériel (ou son antenne d'émission) est installé à l'extérieur, il doit faire l'objet d'une licence.

L'installateur de cet équipement radio doit veiller à ce que l'antenne soit implantée et dirigée de manière à n'émettre aucun champ HF dépassant les limites fixées pour l'ensemble de la population par Santé Canada. Reportez-vous au Code de sécurité 6 que vous pouvez consulter sur le site Web de Santé Canada www.hc-sc.gc.ca/rpb.

Le terme « IC » précédant le numéro de d'accréditation/inscription signifie simplement que le produit est conforme aux spécifications techniques d'Industry Canada.

European Community (EC) directives conformity

This product is in conformity with the protection requirements of EC Council directives 2004/108/EC and 2006/95/EC on the approximation and harmonization of the laws of the Member States relating to electromagnetic compatibility and safety of electrical equipment designed for use within certain voltage limits.

A declaration of conformity with the requirements of the directives has been signed by the Director of Manufacturing and Technical Support, Lexmark International, Inc., S.A., Boigny, France.

This product satisfies the Class B limits of EN 55022 and safety requirements of EN 60950.

European EC directives conformity statement for radio products

The following notices are applicable if your printer has a wireless network card installed

This product is in conformity with the protection requirements of EC Council directives 2004/108/EC, 2006/95/EC, and 1999/5/EC on the approximation and harmonization of the laws of the Member States relating to electromagnetic compatibility, safety of electrical equipment designed for use within certain voltage limits and on radio equipment and telecommunications terminal equipment.

Compliance is indicated by the CE marking.



The Alert sign indicates that there are restrictions within certain member states.

A declaration of conformity with the requirements of the directives is available from the Director of Manufacturing and Technical Support, Lexmark International, S. A., Boigny, France.

The following restrictions apply:

Country/region	Restriction
All countries/regions	This product is for indoor use only. This product may not be used outdoors.
L'Italia	Si fa presente inoltre che l'uso degli apparati in esame è regolamentato da: <ul style="list-style-type: none">• D.Lgs 1.8.2003, n.259, articoli 104 (attività soggette ad autorizzazione generale) e 105 (libero uso), per uso privato;• D.M. 28.5.03, per la fornitura al pubblico dell'accesso R-LAN alle reti e ai servizi di telecomunicazioni.

This product satisfies the limits of EN 55022; safety requirements of EN 60950; radio spectrum requirements of ETSI EN 300 328; and the EMC requirements of EN 55024, ETSI EN 301 489-1 and ETSI EN 301 489-17.

Česky	Společnost Lexmark International, Inc. tímto prohlašuje, že výrobek tento výrobek je ve shodě se základními požadavky a dalšími příslušnými ustanoveními směrnice 1999/5/ES.
Dansk	Lexmark International, Inc. erklærer herved, at dette produkt overholder de væsentlige krav og øvrige relevante krav i direktiv 1999/5/EF.
Deutsch	Hiermit erklärt Lexmark International, Inc., dass sich das Gerät dieses Gerät in Übereinstimmung mit den grundlegenden Anforderungen und den übrigen einschlägigen Bestimmungen der Richtlinie 1999/5/EG befindet.
Ελληνική	ΜΕ ΤΗΝ ΠΑΡΟΥΣΑ Η LEXMARK INTERNATIONAL, INC. ΔΗΛΩΝΕΙ ΟΤΙ ΑΥΤΟ ΤΟ ΠΡΟΪΟΝ ΣΥΜΜΟΡΦΩΝΕΤΑΙ ΠΡΟΣ ΤΙΣ ΟΥΣΙΩΔΕΙΣ ΑΠΑΙΤΗΣΕΙΣ ΚΑΙ ΤΙΣ ΛΟΙΠΕΣ ΣΧΕΤΙΚΕΣ ΔΙΑΤΑΞΕΙΣ ΤΗΣ ΟΔΗΓΙΑΣ 1999/5/ΕΚ.
English	Hereby, Lexmark International, Inc., declares that this type of equipment is in compliance with the essential requirements and other relevant provisions of Directive 1999/5/EC.
Español	Por medio de la presente, Lexmark International, Inc. declara que este producto cumple con los requisitos esenciales y cualesquiera otras disposiciones aplicables o exigibles de la Directiva 1999/5/CE.
Eesti	Käesolevaga kinnitab Lexmark International, Inc., et seade see toode vastab direktiivi 1999/5/EÜ põhinõuetele ja nimetatud direktiivist tulenevatele muudele asjakohastele sätetele.
Suomi	Lexmark International, Inc. vakuuttaa täten, että tämä tuote on direktiivin 1999/5/EY oleellisten vaatimusten ja muiden sitä koskevien direktiivin ehtojen mukainen.
Français	Par la présente, Lexmark International, Inc. déclare que l'appareil ce produit est conforme aux exigences fondamentales et autres dispositions pertinentes de la directive 1999/5/CE.
Magyar	Alulírott, Lexmark International, Inc. nyilatkozom, hogy a termék megfelel a vonatkozó alapvető követelményeknek és az 1999/5/EC irányelv egyéb előírásainak.
Íslenska	Hér með lýsir Lexmark International, Inc. yfir því að þessi vara er í samræmi við grunnkröfur og aðrar kröfur, sem gerðar eru í tilskipun 1999/5/EC.
Italiano	Con la presente Lexmark International, Inc. dichiara che questo prodotto è conforme ai requisiti essenziali ed alle altre disposizioni pertinenti stabilite dalla direttiva 1999/5/CE.
Latviski	Ar šo Lexmark International, Inc. deklarē, ka šis izstrādājums atbilst Direktīvas 1999/5/EK būtiskajām prasībām un citiem ar to saistītajiem noteikumiem.
Lietuvių	Šiuo Lexmark International, Inc. deklaruoja, kad šis produktas atitinka esminius reikalavimus ir kitas 1999/5/EB direktyvos nuostatas.
Malti	Bil-preżenti, Lexmark International, Inc., jiddikjara li dan il-prodott huwa konformi mal-ftigijiet essenzjali u ma dispożizzjonijiet oħrajn relevanti li jinsabu fid-Direttiva 1999/5/KE.
Nederlands	Hierbij verklaart Lexmark International, Inc. dat het toestel dit product in overeenstemming is met de essentiële eisen en de andere relevante bepalingen van richtlijn 1999/5/EG.
Norsk	Lexmark International, Inc. erklærer herved at dette produktet er i samsvar med de grunnleggende krav og øvrige relevante krav i direktiv 1999/5/EF.
Polski	Niniejszym Lexmark International, Inc. oświadcza, że niniejszy produkt jest zgodny z zasadniczymi wymogami oraz pozostałymi stosownymi postanowieniami Dyrektywy 1999/5/EC.

Português	A Lexmark International Inc. declara que este produto está conforme com os requisitos essenciais e outras disposições da Diretiva 1999/5/CE.
Slovensky	Lexmark International, Inc. týmto vyhlasuje, že tento produkt spĺňa základné požiadavky a všetky príslušné ustanovenia smernice 1999/5/ES.
Slovensko	Lexmark International, Inc. izjavlja, da je ta izdelek v skladu z bistvenimi zahtevami in ostalimi relevantnimi določili direktive 1999/5/ES.
Svenska	Härmed intygar Lexmark International, Inc. att denna produkt står i överensstämmelse med de väsentliga egenskapskrav och övriga relevanta bestämmelser som framgår av direktiv 1999/5/EG.

Noise emission levels

The following measurements were made in accordance with ISO 7779 and reported in conformance with ISO 9296.

Note: Some modes may not apply to your product.

1-meter average sound pressure, dBA	
Printing	50
Scanning	not applicable
Copying	not applicable
Ready	inaudible

Values are subject to change. See www.lexmark.com for current values.

Waste from Electrical and Electronic Equipment (WEEE) directive



The WEEE logo signifies specific recycling programs and procedures for electronic products in countries of the European Union. We encourage the recycling of our products. If you have further questions about recycling options, visit the Lexmark Web site at www.lexmark.com for your local sales office phone number.

Product disposal

Do not dispose of the printer or supplies in the same manner as normal household waste. Consult your local authorities for disposal and recycling options.

Temperature information

Ambient temperature	15–32° C (60–90° F)
Shipping temperature	-40–60° C (-40–140° F)

Storage temperature	1–60° C (34–140° F)
---------------------	---------------------

ENERGY STAR



Power consumption

Product power consumption

The following table documents the power consumption characteristics of the product.

Note: Some modes may not apply to your product.

Mode	Description	Power consumption (Watts)
Printing	The product is generating hard-copy output from electronic inputs.	15
Copying	The product is generating hard-copy output from hard-copy original documents.	not applicable
Scanning	The product is scanning hard-copy documents.	not applicable
Ready	The product is waiting for a print job.	6.8
Power Saver	The product is in energy-saving mode.	5.6
Off	The product is plugged into a wall outlet, but the power switch is turned off.	0.9

The power consumption levels listed in the previous table represent time-averaged measurements. Instantaneous power draws may be substantially higher than the average.

Values are subject to change. See www.lexmark.com for current values.

Power Saver

This product is designed with an energy-saving mode called Power Saver. The Power Saver Mode is equivalent to the EPA Sleep Mode. The Power Saver Mode saves energy by lowering power consumption during extended periods of inactivity. The Power Saver Mode is automatically engaged after this product is not used for a specified period of time, called the Power Saver Timeout.

Factory default Power Saver Timeout for this product (in minutes):	30 minutes
--	------------

Off mode

If this product has an off mode which still consumes a small amount of power, then to completely stop product power consumption, disconnect the power supply cord from the wall outlet.

Total energy usage

It is sometimes helpful to calculate the total product energy usage. Since power consumption claims are provided in power units of Watts, the power consumption should be multiplied by the time the product spends in each mode in order to calculate energy usage. The total product energy usage is the sum of each mode's energy usage.

LEXMARK LICENSE AGREEMENTS

PLEASE READ CAREFULLY: BY USING THIS PRODUCT, YOU AGREE TO BE BOUND BY ALL THE TERMS AND CONDITIONS OF THESE LICENSE AGREEMENTS. IF YOU DO NOT AGREE WITH THE TERMS OF THESE LICENSE AGREEMENTS, PROMPTLY RETURN THE PRODUCT UNUSED AND REQUEST A REFUND OF THE AMOUNT YOU PAID. IF YOU ARE INSTALLING THIS PRODUCT FOR USE BY OTHER PARTIES, YOU AGREE TO INFORM THE USERS THAT USE OF THE PRODUCT INDICATES ACCEPTANCE OF THESE TERMS.

CARTRIDGE LICENSE AGREEMENT

I agree that the patented print cartridge(s) shipped with this printing device are sold subject to the following license/agreement: The patented print cartridge(s) contained inside is/are licensed for a single use only and is/are designed to stop working after delivering a fixed amount of ink. A variable amount of ink will remain in the cartridge when replacement is required. After this single use, the license to use the print cartridge terminates, and the used cartridge must be returned only to Lexmark for remanufacturing, refilling or recycling. If I buy another cartridge in the future that is sold subject to the above terms, I accept such terms as to that cartridge. If you do not accept the terms of this single use license/agreement; return this product in its original packaging to your point of purchase. A replacement cartridge sold without these terms is available at www.lexmark.com.

LEXMARK SOFTWARE LICENSE AGREEMENT

This Software License Agreement ("License Agreement") is a legal agreement between you (either an individual or a single entity) and Lexmark International, Inc. ("Lexmark") that, to the extent your Lexmark product or Software Program is not otherwise subject to a written software license agreement between you and Lexmark or its suppliers, governs your use of any Software Program installed on or provided by Lexmark for use in connection with your Lexmark product. The term "Software Program" includes machine-readable instructions, audio/visual content (such as images and recordings), and associated media, printed materials and electronic documentation, whether incorporated into, distributed with or for use with your Lexmark product.

- 1 STATEMENT OF LIMITED WARRANTY.** Lexmark warrants that the media (e.g., diskette or compact disk) on which the Software Program (if any) is furnished is free from defects in materials and workmanship under normal use during the warranty period. The warranty period is ninety (90) days and commences on the date the Software Program is delivered to the original end-user. This limited warranty applies only to Software Program media purchased new from Lexmark or an Authorized Lexmark Reseller or Distributor. Lexmark will replace the Software Program should it be determined that the media does not conform to this limited warranty.
- 2 DISCLAIMER AND LIMITATION OF WARRANTIES.** EXCEPT AS PROVIDED IN THIS LICENSE AGREEMENT AND TO THE MAXIMUM EXTENT PERMITTED BY APPLICABLE LAW, LEXMARK AND ITS SUPPLIERS PROVIDE THE SOFTWARE PROGRAM "AS IS" AND HEREBY DISCLAIM ALL OTHER WARRANTIES AND CONDITIONS, EITHER EXPRESS OR IMPLIED, INCLUDING, BUT NOT LIMITED TO, TITLE, NON-INFRINGEMENT, MERCHANTABILITY AND FITNESS FOR A PARTICULAR PURPOSE, AND ABSENCE OF VIRUSES, ALL WITH REGARD TO THE SOFTWARE PROGRAM. This Agreement is to be read in conjunction with certain statutory provisions, as that may be in force from time to time, that imply warranties or conditions or impose obligations on Lexmark that cannot be excluded or modified. If any such provisions apply, then to the extent Lexmark is able, Lexmark hereby limits its liability for breach of those provisions to one of the following: replacement of the Software Program or reimbursement of the price paid for the Software Program.

- 3 LICENSE GRANT.** Lexmark grants you the following rights provided you comply with all terms and conditions of this License Agreement:
- a Use.** You may Use one (1) copy of the Software Program. The term “Use” means storing, loading, installing, executing, or displaying the Software Program. If Lexmark has licensed the Software Program to you for concurrent use, you must limit the number of authorized users to the number specified in your agreement with Lexmark. You may not separate the components of the Software Program for use on more than one computer. You agree that you will not Use the Software Program, in whole or in part, in any manner that has the effect of overriding, modifying, eliminating, obscuring, altering or de-emphasizing the visual appearance of any trademark, trade name, trade dress or intellectual property notice that appears on any computer display screens normally generated by, or as a result of, the Software Program.
 - b Copying.** You may make one (1) copy of the Software Program solely for purposes of backup, archiving, or installation, provided the copy contains all of the original Software Program’s proprietary notices. You may not copy the Software Program to any public or distributed network.
 - c Reservation of Rights.** The Software Program, including all fonts, is copyrighted and owned by Lexmark International, Inc. and/or its suppliers. Lexmark reserves all rights not expressly granted to you in this License Agreement.
 - d Freeware.** Notwithstanding the terms and conditions of this License Agreement, all or any portion of the Software Program that constitutes software provided under public license by third parties (“Freeware”) is licensed to you subject to the terms and conditions of the software license agreement accompanying such Freeware, whether in the form of a discrete agreement, shrink-wrap license, or electronic license terms at the time of download. Use of the Freeware by you shall be governed entirely by the terms and conditions of such license.
- 4 TRANSFER.** You may transfer the Software Program to another end-user. Any transfer must include all software components, media, printed materials, and this License Agreement and you may not retain copies of the Software Program or components thereof. The transfer may not be an indirect transfer, such as a consignment. Prior to the transfer, the end-user receiving the transferred Software Program must agree to all these License Agreement terms. Upon transfer of the Software Program, your license is automatically terminated. You may not rent, sublicense, or assign the Software Program except to the extent provided in this License Agreement, and any attempt to do so shall be void.
- 5 UPGRADES.** To Use a Software Program identified as an upgrade, you must first be licensed to the original Software Program identified by Lexmark as eligible for the upgrade. After upgrading, you may no longer use the original Software Program that formed the basis for your upgrade eligibility.
- 6 LIMITATION ON REVERSE ENGINEERING.** You may not alter, decrypt, reverse engineer, reverse assemble, reverse compile or otherwise translate the Software Program, except as and to the extent expressly permitted to do so by applicable law for the purposes of inter-operability, error correction, and security testing. If you have such statutory rights, you will notify Lexmark in writing of any intended reverse engineering, reverse assembly, or reverse compilation. You may not decrypt the Software Program unless necessary for the legitimate Use of the Software Program.
- 7 ADDITIONAL SOFTWARE.** This License Agreement applies to updates or supplements to the original Software Program provided by Lexmark unless Lexmark provides other terms along with the update or supplement.
- 8 LIMITATION OF REMEDIES.** To the maximum extent permitted by applicable law, the entire liability of Lexmark, its suppliers, affiliates, and resellers, and your exclusive remedy shall be as follows: Lexmark will provide the express limited warranty described above. If Lexmark does not remedy defective media as warranted, you may terminate your license and your money will be refunded upon the return of all of your copies of the Software Program.

9 LIMITATION OF LIABILITY. To the maximum extent permitted by applicable law, for any claim arising out of Lexmark's limited warranty, or for any other claim whatsoever related to the subject matter of this Agreement, Lexmark's and its suppliers' liability for all types of damages, regardless of the form of action or basis (including contract, breach, estoppel, negligence, misrepresentation, or tort), shall be limited to the greater of \$5,000 or the money paid to Lexmark or its Authorized remarketers for the license hereunder for the Software Program that caused the damages or that is the subject matter of, or is directly related to, the cause of action.

IN NO EVENT WILL LEXMARK, ITS SUPPLIERS, SUBSIDIARIES, OR RESELLERS BE LIABLE FOR ANY SPECIAL, INCIDENTAL, INDIRECT, EXEMPLARY, PUNITIVE, OR CONSEQUENTIAL DAMAGES (INCLUDING BUT NOT LIMITED TO LOST PROFITS OR REVENUES, LOST SAVINGS, INTERRUPTION OF USE OR ANY LOSS OF, INACCURACY IN, OR DAMAGE TO, DATA OR RECORDS, FOR CLAIMS OF THIRD PARTIES, OR DAMAGE TO REAL OR TANGIBLE PROPERTY, FOR LOSS OF PRIVACY ARISING OUT OR IN ANY WAY RELATED TO THE USE OF OR INABILITY TO USE THE SOFTWARE PROGRAM, OR OTHERWISE IN CONNECTION WITH ANY PROVISION OF THIS LICENSE AGREEMENT), REGARDLESS OF THE NATURE OF THE CLAIM, INCLUDING BUT NOT LIMITED TO BREACH OF WARRANTY OR CONTRACT, TORT (INCLUDING NEGLIGENCE OR STRICT LIABILITY), AND EVEN IF LEXMARK, OR ITS SUPPLIERS, AFFILIATES, OR REMARKETERS HAVE BEEN ADVISED OF THE POSSIBILITY OF SUCH DAMAGES, OR FOR ANY CLAIM BY YOU BASED ON A THIRD-PARTY CLAIM, EXCEPT TO THE EXTENT THIS EXCLUSION OF DAMAGES IS DETERMINED LEGALLY INVALID. THE FOREGOING LIMITATIONS APPLY EVEN IF THE ABOVE-STATED REMEDIES FAIL OF THEIR ESSENTIAL PURPOSE.

- 10 TERM.** This License Agreement is effective unless terminated or rejected. You may reject or terminate this license at any time by destroying all copies of the Software Program, together with all modifications, documentation, and merged portions in any form, or as otherwise described herein. Lexmark may terminate your license upon notice if you fail to comply with any of the terms of this License Agreement. Upon such termination, you agree to destroy all copies of the Software Program together with all modifications, documentation, and merged portions in any form.
- 11 TAXES.** You agree that you are responsible for payment of any taxes including, without limitation, any goods and services and personal property taxes, resulting from this Agreement or your Use of the Software Program.
- 12 LIMITATION ON ACTIONS.** No action, regardless of form, arising out of this Agreement may be brought by either party more than two years after the cause of action has arisen, except as provided under applicable law.
- 13 APPLICABLE LAW.** This Agreement is governed by the laws of the Commonwealth of Kentucky, United States of America. No choice of law rules in any jurisdiction shall apply. The UN Convention on Contracts for the International Sale of Goods shall not apply.
- 14 UNITED STATES GOVERNMENT RESTRICTED RIGHTS.** The Software Program has been developed entirely at private expense. Rights of the United States Government to use the Software Program is as set forth in this Agreement and as restricted in DFARS 252.227-7014 and in similar FAR provisions (or any equivalent agency regulation or contract clause).
- 15 CONSENT TO USE OF DATA.** You agree that Lexmark, its affiliates, and agents may collect and use information you provide in relation to support services performed with respect to the Software Program and requested by you. Lexmark agrees not to use this information in a form that personally identifies you except to the extent necessary to provide such services.
- 16 EXPORT RESTRICTIONS.** You may not (a) acquire, ship, transfer, or reexport, directly or indirectly, the Software Program or any direct product therefrom, in violation of any applicable export laws or (b) permit the Software Program to be used for any purpose prohibited by such export laws, including, without limitation, nuclear, chemical, or biological weapons proliferation.
- 17 AGREEMENT TO CONTRACT ELECTRONICALLY.** You and Lexmark agree to form this License Agreement electronically. This means that when you click the "Agree" or "Yes" button on this page or use this product, you acknowledge your agreement to these License Agreement terms and conditions and that you are doing so with the intent to "sign" a contract with Lexmark.

- 18 CAPACITY AND AUTHORITY TO CONTRACT.** You represent that you are of the legal age of majority in the place you sign this License Agreement and, if applicable, you are duly authorized by your employer or principal to enter into this contract.
- 19 ENTIRE AGREEMENT.** This License Agreement (including any addendum or amendment to this License Agreement that is included with the Software Program) is the entire agreement between you and Lexmark relating to the Software Program. Except as otherwise provided for herein, these terms and conditions supersede all prior or contemporaneous oral or written communications, proposals, and representations with respect to the Software Program or any other subject matter covered by this License Agreement (except to the extent such extraneous terms do not conflict with the terms of this License Agreement, any other written agreement signed by you and Lexmark relating to your Use of the Software Program). To the extent any Lexmark policies or programs for support services conflict with the terms of this License Agreement, the terms of this License Agreement shall control.

Networking glossary

ad hoc mode	A setting for a wireless device that lets it communicate directly with other wireless devices without an access point or router
ad hoc network	A wireless network that does not use an access point
AutoIP address	An IP address automatically assigned by a network device. If the device is set to use DHCP, but no DHCP server is available, an AutoIP address may be assigned by the device.
BSS (Basic Service Set)	Basic Service Set describes the type of wireless network that you are using. The BSS type can be one of the following: Infrastructure network or Ad-Hoc network.
channel	A specific radio frequency used by two or more wireless devices to communicate with each other. All devices on the network must use the same channel.
DHCP (Dynamic Host Configuration Protocol)	A language used by DHCP servers
DHCP IP address	An IP address automatically assigned by a DHCP server
DHCP server	A computer or router that gives a unique IP address to each device on the network. Unique addresses prevent conflicts.
infrastructure mode	A setting for a wireless device that lets it communicate directly with other wireless devices using an access point or router
installation cable	Connects the printer to the computer temporarily during some methods of installation.
internal wireless print server	A device that lets computers and printers talk to each other over a network without cables
IP (Internet Protocol) address	The network address of a computer or printer. Each device on the network has its own network address. The address may be assigned manually by you (Static IP address), automatically by the DHCP server (DHCP IP address), or automatically by the device (AutoIP address).
ipconfig	A command that displays the IP address and other network information of a Windows computer
MAC (Media Access Control) address	A hardware address that uniquely identifies each device on a network. You can usually find the MAC address printed on the device.
MAC filtering	A method of limiting access to your wireless network by specifying which MAC addresses may communicate on the network. This setting may be specified on wireless routers or access points.
network adapter/card	A device that lets computers or printers talk to each other over a network
network hub	A device that connects multiple devices on a wired network
network name	See "SSID (Service Set Identifier)" on page 84
ping	A test to see if your computer can communicate with another device
printer nickname	The name you assign to your printer so that you and others can identify it on the network

router	A device that shares a single Internet connection with multiple computers or other devices. The basic router controls network traffic.
security key	A password, such as a WEP key or a WPA pass phrase, used to make a network secure
signal strength	Measure of how strongly a transmitted signal is being received
SSID (Service Set Identifier)	The name of a wireless network. When you connect a printer to a wireless network, the printer needs to use the same SSID as the network. Also referred to as network name or BSS (Basic Service Set).
Static IP address	An IP address assigned manually by you
switch	A device similar to a network hub that can connect different networks together
UAA (Universally Administered Address)	An address assigned to a network printer or print server by the manufacturer. To find the UAA, print a network setup page and look for the UAA listing.
USB cable	A lightweight, flexible cable that lets the printer communicate with the computer at much higher speeds than parallel cables
USB port	A small, rectangular port on the back of the computer that connects the peripheral devices using a USB cable, and lets them communicate at high speeds
WEP (Wired Equivalent Privacy)	A security setting that helps prevent unauthorized access to a wireless network. Other possible security settings are WPA and WPA2.
wireless access point	A device that connects wireless devices together to form a wireless network
wireless router	A router that also serves as a wireless access point
Wi-Fi	An industry term that describes the technology used to create an interoperable wireless local area network (WLAN).
WPA (Wi-Fi Protected Access)	A security setting that helps prevent unauthorized access to a wireless network. WPA is not supported on ad hoc wireless networks. Other possible security settings are WEP and WPA2.
WPA2	A newer version of WPA. Older routers are less likely to support this. Other possible security settings are WPA and WEP.

Index

A

- ad hoc wireless network
 - adding a printer 23
 - creating 20
- additional computers
 - installing wireless printer 19
- aligning print cartridges 47
- assigning IP address 30

C

- cable
 - installation 26
 - USB 26
- canceling print jobs 38
- cartridges, print
 - aligning 47
 - cleaning 47
 - installing 45
 - ordering 50
 - preserving 49
 - removing 46
 - using genuine Lexmark 46
 - wiping 48
- CD
 - printing photos from 43
- changing wireless settings after installation (Mac) 18
- changing wireless settings after installation (Windows) 18
- cleaning
 - exterior of the printer 49
- cleaning print cartridge nozzles 47
- Communication not available message 71
- configuring
 - IP address 18
- connection
 - configurations 28
- custom-size paper, loading 40
- custom-size paper, printing 40

D

- document
 - multiple copies, printing 35
- documents
 - printing 34

E

- emission notices 73, 74, 75, 76, 77
- envelopes
 - loading 33, 38
 - printing 38
- exterior of the printer
 - cleaning 49

F

- FCC notices 73, 74
- finding
 - information 8
 - MAC address 29
 - publications 8
 - Web site 8
- finding IP address of computer (Mac) 29
- firewall on computer 63

G

- glossy and photo paper, loading 34
- glossy paper, loading 32
- greeting cards
 - loading 33

I

- index cards
 - loading 33
- information needed for setting up printer on wireless network 16
- information, finding 8
- installation
 - cable 26
- installing
 - network printer 30
 - print cartridges 45
 - printer software 12, 57
- installing printer
 - on wireless network (Mac) 17
 - on wireless network (Windows) 17
- installing wireless printer
 - additional computers 19
- IP address 29
 - configuring 18
- IP address, assigning 30

- iron-on transfers, loading 32

K

- key index 31

L

- labels, loading 33
- labels, printing 39
- last page first, printing 36
- loading
 - custom-size paper 40
 - envelopes 33, 38
 - glossy and photo paper 34
 - glossy paper 32
 - greeting cards 33
 - index cards 33
 - iron-on transfers 32
 - labels 33
 - paper 32, 34
 - photo cards 33
 - photo paper 32
 - postcards 33
 - transparencies 33

M

- MAC address 28
- MAC address filtering 28
- MAC address, finding 29
- Mac printer software
 - using 14
- Macintosh
 - installing printer on wireless network 17
- multiple copies, printing 35
- multiple WEP keys 31

N

- network printer
 - installing 30
- network security 28
- network setup page
 - printing 58
- networking
 - finding IP address of computer 29
 - finding IP address of computer (Mac) 29

- finding IP address of printer 29
- IP addresses 29
- noise emission levels 77
- notices 73, 74, 75, 76, 77, 78, 79
- N-up feature 36

O

- ordering paper and other supplies 50

P

- page does not print 54
- paper and other supplies
 - ordering 50
- paper exit tray 10
- paper feed guard 10
- paper guide 10
- paper support 10
- paper, loading 32, 34
- parts
 - paper exit tray 10
 - paper feed guard 10
 - paper guide 10
 - paper support 10
 - USB port 10
 - Wi-Fi indicator 10
- password 28
- photo cards, loading 33
- photo paper, loading 32
- photos
 - printing from CD using the computer 43
 - printing from digital camera
 - connected to computer 43
 - printing from removable storage
 - device connected to computer 43
- postcards
 - loading 33
- power button is not lit 52
- print cartridge nozzles, cleaning 47
- print cartridges
 - aligning 47
 - cleaning 47
 - installing 45
 - ordering 50
 - preserving 49
 - refilling 46
 - removing 46
 - using genuine Lexmark 46

- wiping 48
- print jobs
 - canceling 38
- print settings
 - saving and deleting 41
- printer cannot connect to wireless network 60
- printer does not print
 - wireless 63
- printer does not print wirelessly 63
- printer software
 - installing 12
 - reinstalling 57
 - removing 57
- printing
 - collate 35
 - custom-size paper 40
 - documents 34
 - envelopes 38
 - labels 39
 - last page first 36
 - multiple copies 35
 - multiple pages on one sheet 36
 - network setup page 58
 - photos from CD using the computer 43
 - photos from digital camera
 - connected to computer 43
 - photos from removable storage
 - device connected to computer 43
 - reverse page order 36
 - specialty documents 41
 - Web page 34
- printing photos
 - from digital camera connected to computer 43
 - from flash drive connected to computer 43
 - from memory card connected to computer 43
- publications, finding 8

R

- recycling
 - WEEE statement 77
- refilling print cartridges 46
- removing print cartridges 46
- reverse page order 36

S

- safety information 7
- saving and deleting print settings 41
- security information 10
 - wireless network 28
- security key 28
- Service Center 52
- setting up printer
 - on wireless network (Mac) 17
 - on wireless network (Windows) 17
- setup troubleshooting
 - page does not print 54
 - power button is not lit 52
 - software did not install 53
- software
 - removing and reinstalling 57
 - Service Center 52
 - XPS driver 12
- software did not install 53
- solving printer communication problems 56
- specialty documents, printing 41
- SSID
 - wireless network 28

T

- Toolbar
 - printing a Web page 34
- transparencies
 - loading 33
- troubleshooting
 - printer communication problems 56
 - Service Center 52
 - wireless network 59
- troubleshooting, setup
 - page does not print 54
 - power button is not lit 52
 - software did not install 53
- troubleshooting, wireless
 - changing wireless settings after installation (Mac) 18
 - changing wireless settings after installation (Windows) 18
 - printer cannot connect to wireless network 60
 - Wi-Fi indicator light is blinking orange 65, 67
 - Wi-Fi indicator light is not lit 63

Wi-Fi indicator light is still orange 69

U

USB

cable 26

USB port 10

enabling 58

using

Mac printer software 14

W

Web page

printing 34

Web site

finding 8

WEP key

key index 31

Windows

installing printer on wireless network 17

Windows software

FastPics 13

Fax Setup Utility 13

Fax Solutions Software 13

Printing Preferences 13

Productivity Studio 13

Wireless Setup Utility 13

wireless

printer does not print 63

troubleshooting 63

with USB 28

wireless installation

will not continue after attaching USB cable 59

wireless network

adding a printer to existing ad hoc network 23

common home configurations 24

creating an ad hoc network 20

information needed for setting up wireless printing 16

installing printer on (Mac) 17

installing printer on

(Windows) 17

networking overview 23

security information 28

signal strength 28

SSID 28

troubleshooting 59

types of wireless networks 27

wireless network compatibility 16

wireless print server

not installed 70

wireless settings

changing after installation (Mac) 18

wireless setup

information needed for 16

wireless signal

strength 28

wireless troubleshooting

changing wireless settings after installation (Mac) 18

changing wireless settings after installation (Windows) 18

printer cannot connect to wireless network 60

Wi-Fi indicator light is blinking orange 65, 67

Wi-Fi indicator light is not lit 63

Wi-Fi indicator light is still orange 69

Wi-Fi indicator 10

description of colors 17

interpreting colors 17

light is not lit 63

Wi-Fi indicator light is blinking orange 65, 67

Wi-Fi indicator light is green

printer does not print 63

Wi-Fi indicator light is still orange 69

X

XPS driver

installing 12

Free Manuals Download Website

<http://myh66.com>

<http://usermanuals.us>

<http://www.somanuals.com>

<http://www.4manuals.cc>

<http://www.manual-lib.com>

<http://www.404manual.com>

<http://www.luxmanual.com>

<http://aubethermostatmanual.com>

Golf course search by state

<http://golfingnear.com>

Email search by domain

<http://emailbydomain.com>

Auto manuals search

<http://auto.somanuals.com>

TV manuals search

<http://tv.somanuals.com>