

1

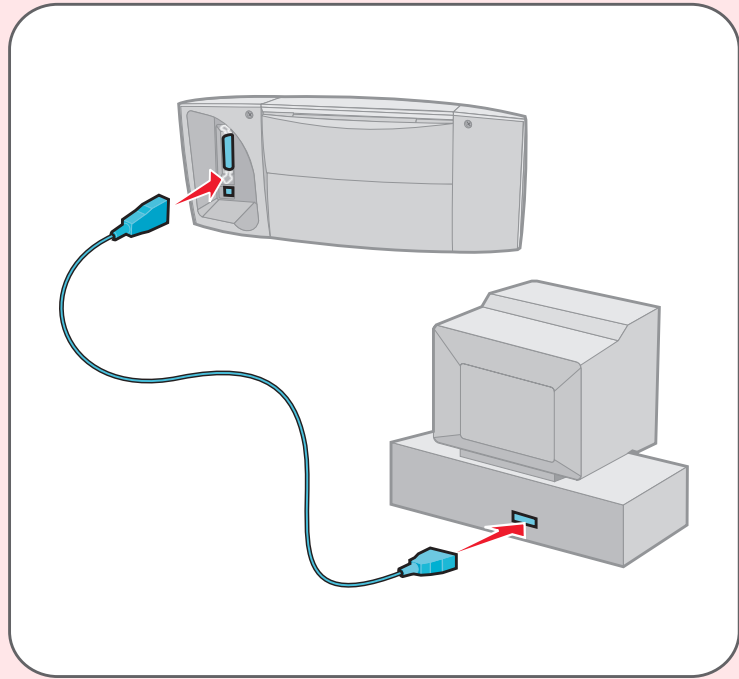

2

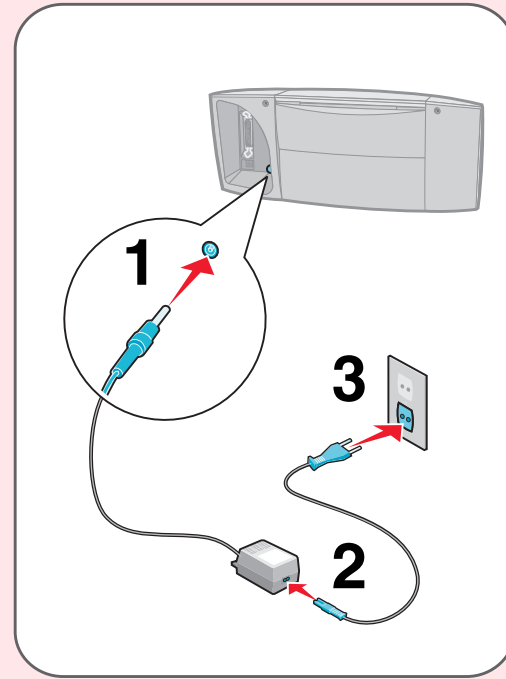

3

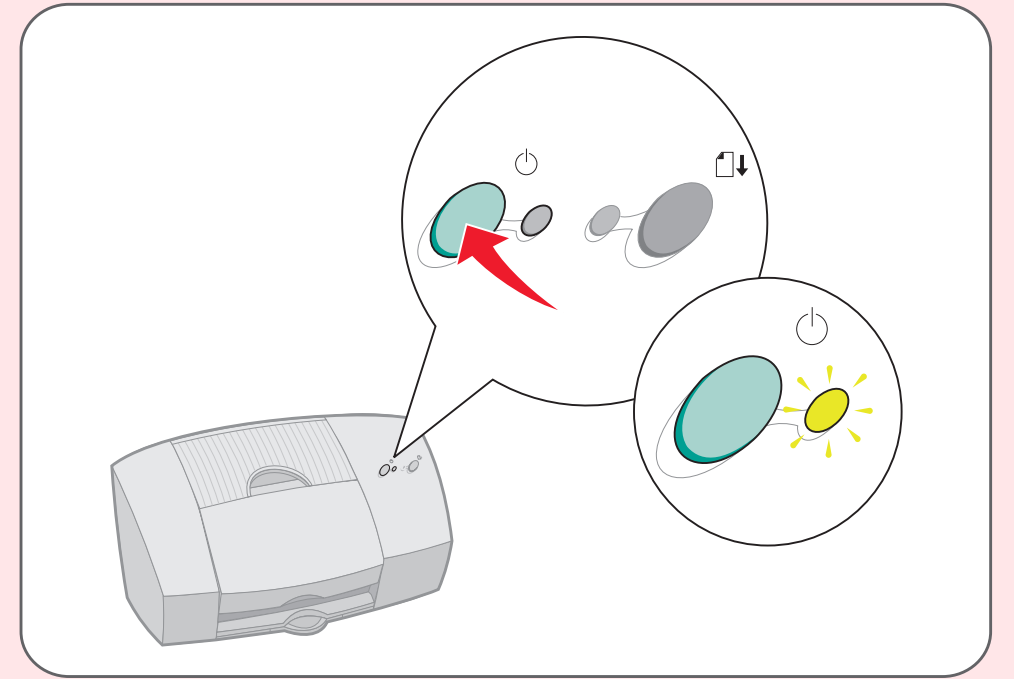

4

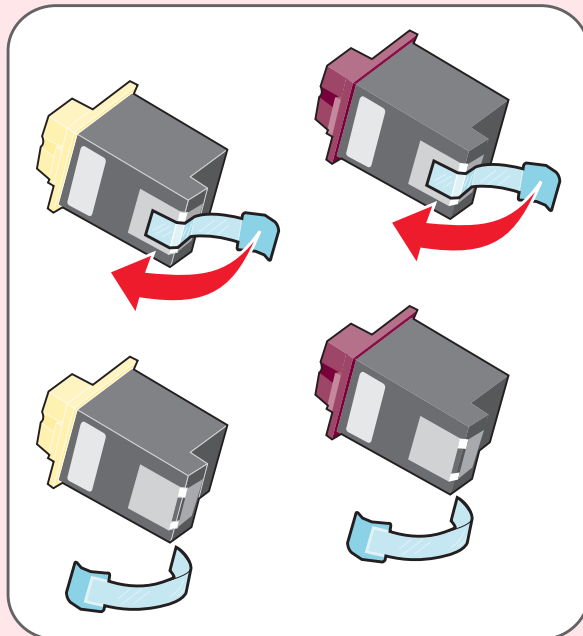

5

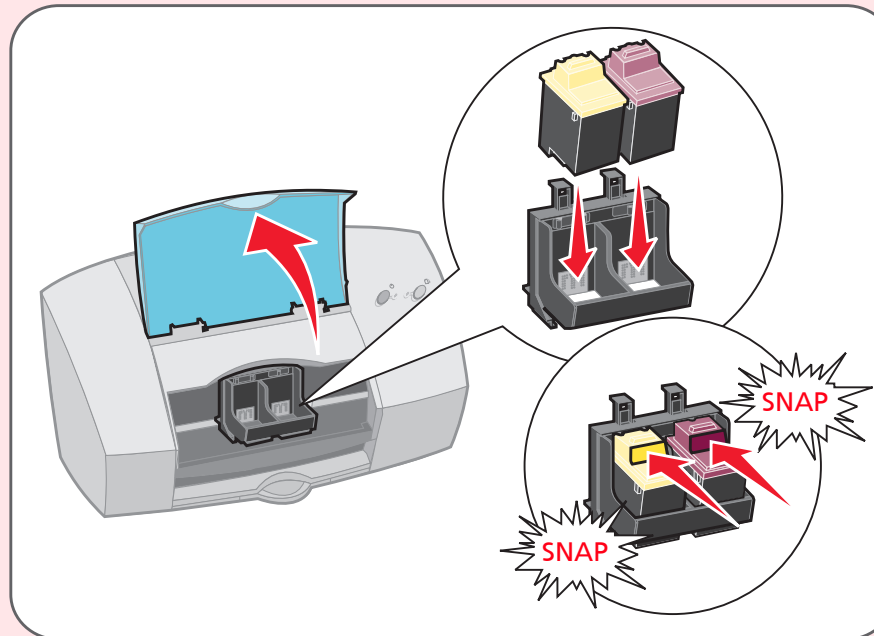

6

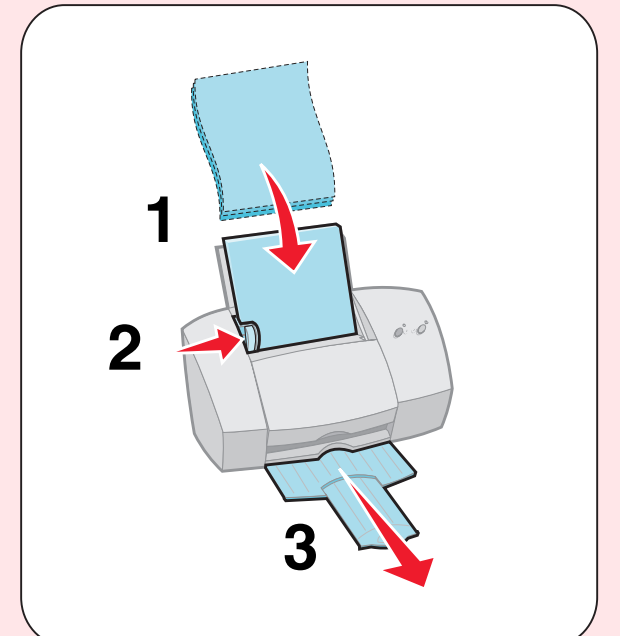

7

Windows 95
Windows 98
Windows NT 4.0
Windows 2000
Windows Me

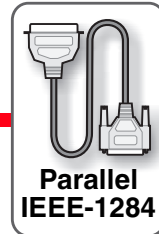

Parallel
IEEE-1284

Windows 98
Windows 2000
Windows Me

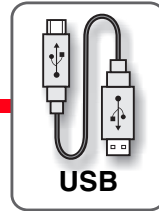

USB

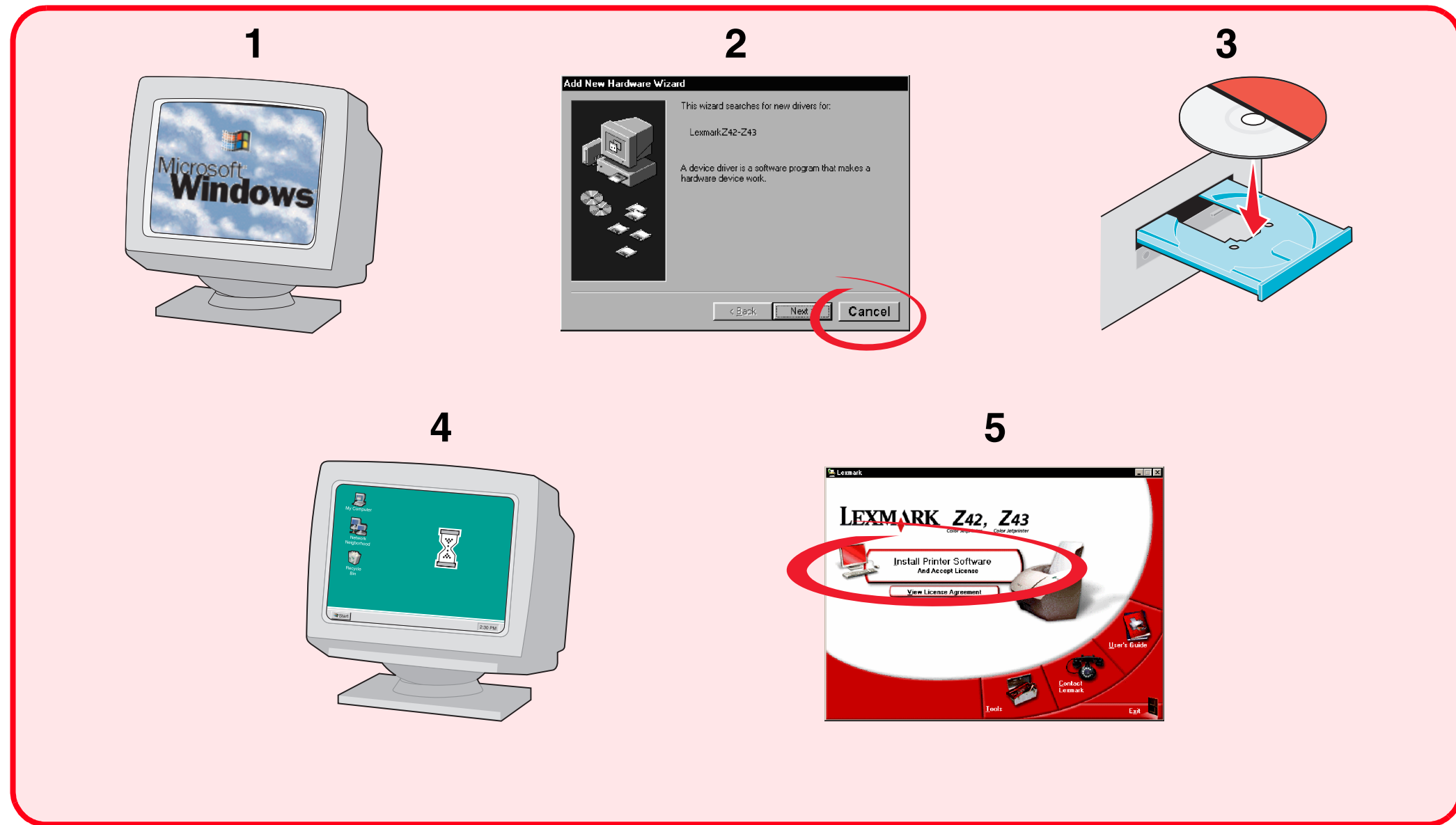

Mac OS 8.6
Mac OS 9

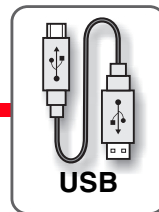

USB

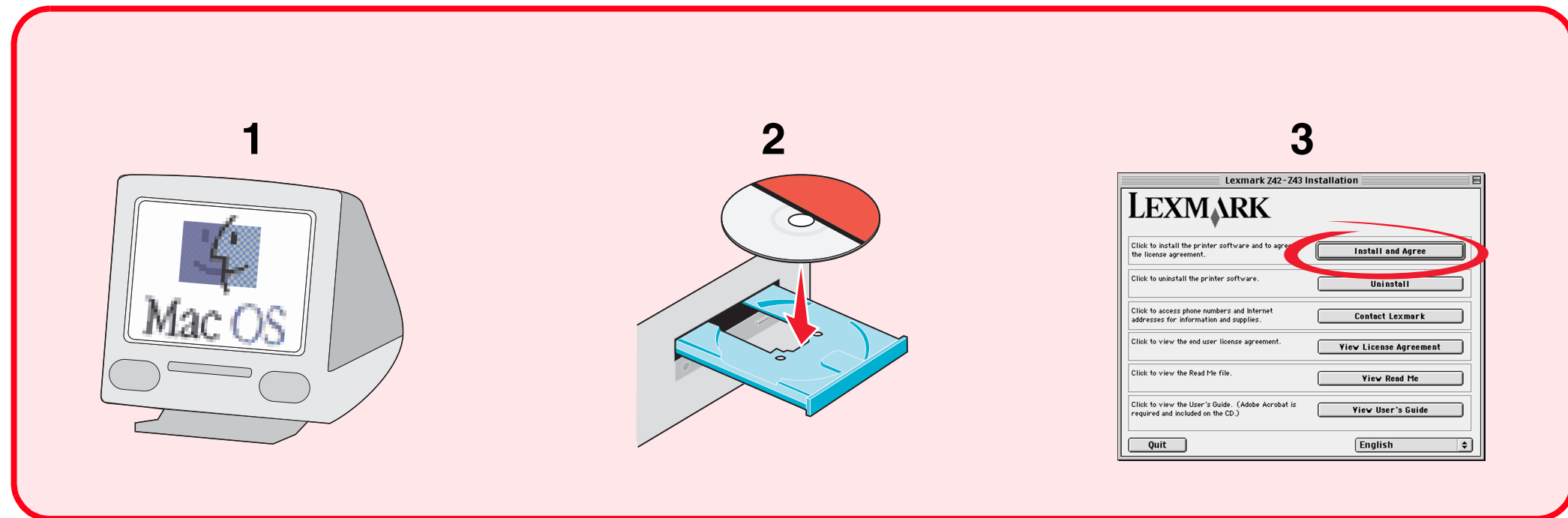

Free Manuals Download Website

<http://myh66.com>

<http://usermanuals.us>

<http://www.somanuals.com>

<http://www.4manuals.cc>

<http://www.manual-lib.com>

<http://www.404manual.com>

<http://www.luxmanual.com>

<http://aubethermostatmanual.com>

Golf course search by state

<http://golfingnear.com>

Email search by domain

<http://emailbydomain.com>

Auto manuals search

<http://auto.somanuals.com>

TV manuals search

<http://tv.somanuals.com>