

## Operating instructions

Freezer with explosion-proof interior container

Read the operating instructions before switching on for the first time

Page 12

GB

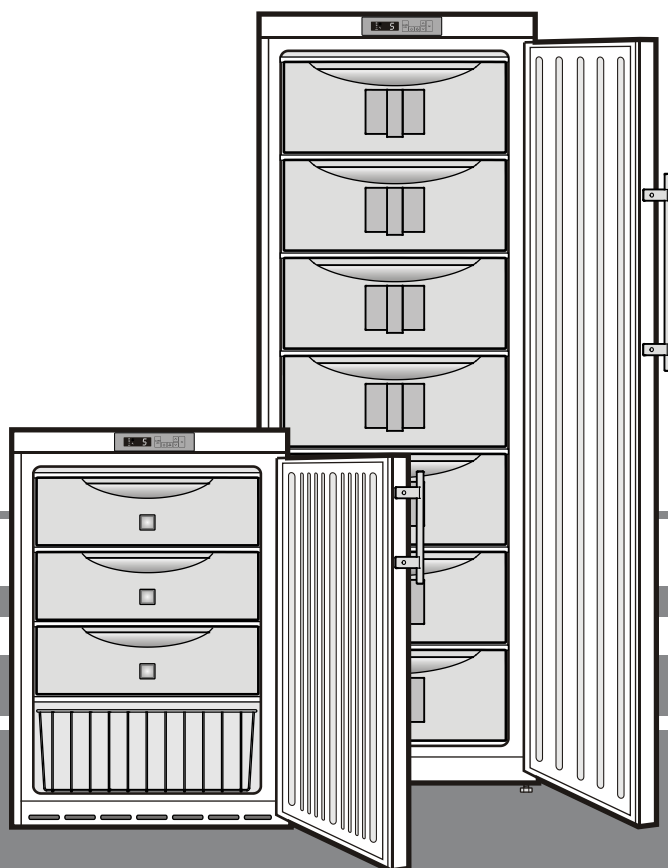

**7082 273-00**

LGex 910

**LIEBHERR**

## Disposal notes

- **Keep packaging materials away from children - polythene sheets and bags can cause suffocation!**
- Please return the packaging to an official collection point.

**Your old appliance:** This contains some reusable materials and should be disposed of properly - not simply with unsorted household refuse.

- Discarded appliances should be disabled: Remove the plug, cut through the connection cable and render the catch unusable so that children cannot become trapped inside.
- Ensure that the refrigerant circuit is not damaged when the appliance that is no longer needed is taken away for disposal.
- Details of the refrigerant can be found on the type plate.
- Appliances which are no longer needed must be disposed of in a professional and appropriate way, in accordance with the current local regulations and laws.



## Description of appliance and equipment

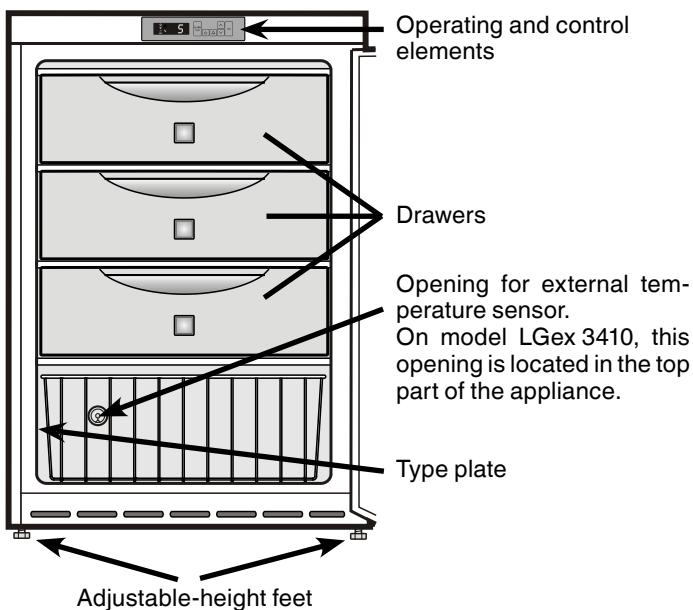

## Other features

- Audible and visual temperature alarm (adjustable limits).
- Audible and visual door open alarm.
- Floating contact for connection to a remote monitoring system.
- Serial interface (RS485) for external temperature and alarm documentation.
- Maximum/minimum interior temperature are stored.
- Last 3 temperature alarms are saved with time, date and duration of alarm.
- Last 3 power cuts are saved with time, date and duration of power cut.
- Opening for installing a reference sensor.

**It is essential to use these safety facilities to avoid damage to stored items. These facilities must not be deactivated or decommissioned!**

## Safety instructions and warnings

- To prevent injury or damage to the unit, the appliance should be unpacked and set up by two people.
- In the event that the appliance is damaged on delivery, contact the supplier immediately before connecting to the mains.
- To guarantee safe operation, ensure that the appliance is set up and connected as described in these operating instructions.
- Disconnect the appliance from the mains if any fault occurs. Pull out the plug, switch off or remove the fuse.
- When disconnecting the appliance, pull on the plug, not on the cable.
- Any repairs and work on the appliance should only be carried out by the customer service department, as unauthorised work could prove highly dangerous for the user. The same applies to changing the mains power cable.
- Do not stand on the plinth, drawers or doors or use them to support anything else.
- This appliance is not intended for use by persons (including children) with reduced physical, sensory or mental capabilities or lack of experience and knowledge unless they have been given initial supervision or instruction concerning use of the appliance by a person responsible for their safety. Children should be supervised to ensure that they do not play with the appliance.
- Avoid prolonged skin contact with cold surfaces or chilled/frozen food. This could cause pain, numbness and frostbite. In the case of prolonged skin contact, protective measures should be taken, e.g. gloves should be worn.
- Do not consume food which has been stored for too long, as it could cause food poisoning.
- If you have a lockable appliance, do not keep the key near the appliance or within reach of children.
- Do not allow naked flames or ignition sources to enter the appliance. When transporting and cleaning the appliance ensure that the refrigerant circuit is not damaged. In the event of damage, make sure that there are no ignition sources nearby and keep the room well ventilated.
- Do not use electrical appliances inside the appliance.
- Do not connect the appliance to the supply with other equipment using an extension cable. This can cause the extension socket to overheat.
- Do not install the appliance in the immediate vicinity of an air-conditioning unit. The appliance should also not be operated under a wall-mounted air-conditioning unit.
- The appliance is **not** suitable for storing drugs pursuant to DIN 58345.
- The appliance is **not** suitable for storing blood bottles pursuant to DIN 58371.
- The appliance is **not** suitable for storing blood plasma pursuant to DIN 58375.
- In special fields of application which are subject to their own standard, the user is responsible for complying with this standard.
- The appliance is designed for use in enclosed areas. Do not operate the appliance outdoors or in areas where it is exposed to splash water or damp conditions.

## Range of appliance use

The interior, which is free from sources of ignition, is used for storing flammable substances in open or closed containers and is therefore classified as a Zone 2 hazardous area.

The appliance is **not** suitable for use in explosion-hazard areas.

For the storage of valuable or temperature-sensitive substances or products the use of an independent, constantly monitoring alarm system is necessary.

This alarm system must be designed so that each alarm status is detected immediately by an authorised person who can then take appropriate action.

Position the temperature sensor for this system in the upper part of the interior container (see **Opening for external temperature sensor**).

<p><b>INNENRAUM EXPLOSIONSGESCHÜTZT!</b> <b>EXPLOSION-PROOF INTERIOR!</b> <b>CUVE INTÉRIEURE ANTIDÉFLAGRANTE !</b></p> <p>II 3G Ex nA II T6 SEV 08 ATEX 0150 X</p> <p>Innentemperaturbereich: -9 bis -26°C Interior temperature range: -9 to -26°C Gamme de températures intérieures : -9 à -26 °C</p>	<p><b>Achtung!</b> Kunststoffteile nur mit feuchtem Tuch reinigen! Gefahr elektrostatischer Aufladung!</p> <p><b>Warning!</b> Only clean plastic parts with a damp cloth! Risk of electrostatic discharge.</p> <p><b>Attention !</b> Nettoyer les éléments plastique avec un chiffon humide uniquement ! Danger de décharge électrostatique.</p>
--	--

LGUex 1500

<p><b>INNENRAUM EXPLOSIONSGESCHÜTZT!</b> <b>EXPLOSION-PROOF INTERIOR!</b> <b>CUVE INTÉRIEURE ANTIDÉFLAGRANTE !</b></p> <p>II 3G Ex nA II T6 SEV 08 ATEX 0151 X</p> <p>Innentemperaturbereich: -9 bis -30°C Interior temperature range: -9 to -30°C Gamme de températures intérieures : -9 à -30 °C</p>	<p><b>Achtung!</b> Kunststoffteile nur mit feuchtem Tuch reinigen! Gefahr elektrostatischer Aufladung!</p> <p><b>Warning!</b> Only clean plastic parts with a damp cloth! Risk of electrostatic discharge.</p> <p><b>Attention !</b> Nettoyer les éléments plastique avec un chiffon humide uniquement ! Danger de décharge électrostatique.</p>
--	--

LGex 3410

## Dimensions

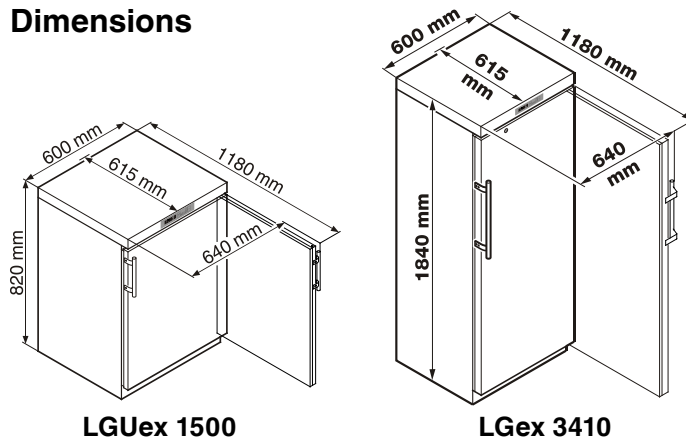

LGUex 1500

LGex 3410

## Operating and control elements

- ① **ON/OFF** button (to switch the appliance on and off)
- ② Temperature setting buttons
- ③ **Set** button (Enter)
- ④ **Audible warning** on/off button
- ⑤ Button for calling up stored alarm events
- ⑥ Temperature display

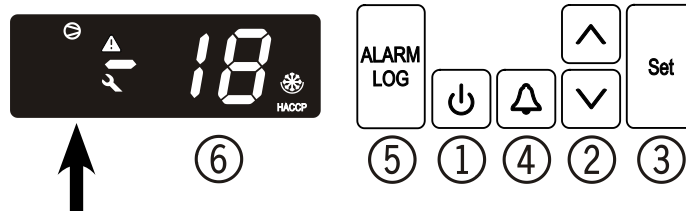

### Control elements

- ⊖ Compressor is running
- ⊖ LED flashing - refrigeration unit switches on after a delay. The compressor will start automatically after the pressure in the refrigerant circuit has equalised.
- AUX Temperature display via product sensor is activated
- ⚠ Alarm function
- 🔧 If 🔧 appears in the display, the appliance has a fault. Consult your nearest customer service point.

### HACCp (Hazard Analysis Critical Control Point)

The HACCp display means that the power supply and interior temperature of the appliance are recorded. If HACCp flashes in the display, there has either been a power failure or the temperature in the appliance exceeded the permissible range.

## Safety lock

The lock in the appliance door is equipped with a safety mechanism.

### Locking the appliance:

- Insert the key as shown by arrow 1.
- Turn the key 90°.

To unlock the appliance, the same procedure must be repeated in the same order.

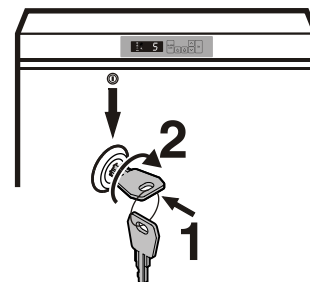

## Climate rating

The appliance is set to operate within specific ambient temperature limits. These temperature limits should not be exceeded. The appliance has the following climate rating:

Climate rating	Ambient temperature
SN-ST (5)	+10°C to +38°C

The appliance complies with the relevant safety regulations and EC Directives 2004/108/EC, 2006/95/EC and ATEX 94/9/EC (EN/IEC 60079-15, IEC 60079-0, EN 1127-1).

## Setting up

- Avoid positioning the appliance in direct sunlight or near cookers, radiators and similar sources of heat.
- The floor on which the appliance stands should be horizontal and level. Compensate for uneven floors with the adjustable feet.
- Always ensure that there is good ventilation and that the outward flowing air is able to escape.
- Standard EN 378 specifies that the room in which you install your appliance must have a volume of 1 m<sup>3</sup> per 8 g of R 600a refrigerant used in the appliance, so as to avoid the formation of inflammable gas/air mixtures in the room where the appliance is located in the event of a leak in the refrigerant circuit. The quantity of refrigerant used in your appliance is indicated on the type plate on the inside of the appliance.

## Connecting to the mains

Power supply (AC) and voltage at the operating point must comply with the details on the type plate.

The socket must be fused with a 10 A fuse or higher, it must be away from the rear of the appliance and must be easily accessible.

**Connect the appliance with a properly earthed fused plug and socket only.**

## Switching the appliance on and off

Connect the appliance to the mains - the display reads **OFF**.



**To switch the appliance on:** Keep the **ON/OFF** button  pressed for approx. 5 seconds - the display reads **ON**.

No alarm is displayed or sounded when the appliance is switched on for the first time.

When it is switched on a second time the appliance is in a status that is the equivalent of an alarm status (power failure, interior temperature too high).

The **HACCP** LED at the bottom right of the display flashes.

Press button .

Press  +  for 5 seconds. The display will read **rE5**.





The HACCP LED will now light up permanently.

Press  for 5 seconds.

The electronic control system will switch back to normal operating mode.

**To switch the appliance off:** Keep the **ON/OFF** button  pressed for approx. 5 seconds - the display reads **OFF**.

## Setting the temperature

- Press button  for 1 second. The temperature display flashes.
- To increase the temperature (warmer): press button .
- To reduce the temperature (colder): press button .
- Press button  again.

The desired temperature setting is saved.

### Adjustable temperature range

**LGUex 1500** from -9°C to -26°C

**LGex 3410** from -9°C to -30°C

## Calling up the temperature history

The maximum and minimum interior temperature are stored electronically. These temperatures can be called up.

**To call up the temperature:**

Press  for 5 seconds. Display = **rE1**

 Display = **rA3**

 Display = **rC1**

 Display = **rC3**

Press  for 5 seconds. Display = **rE**

 Display = **3** Period in hours in which the interior temperatures were measured. In this example it was 3 hours.

 Display = **rE**

 Display = **rH**

 Display = **-18** Maximum (warmest) temperature measured during these 3 hours.

 Display = **rH**

 Display = **rL**

 Display = **-22** Lowest temperature measured during these 3 hours.

To set the observation period back to zero, proceed as follows.

 Display = **rL**

 Display = **rH**

 Display = **rE**

 Display = **3**

Press  for 5 seconds. Display = **rE5**.

Press  for 5 seconds.

The electronic control system will switch back to normal operating mode.

## Adjusting the alarm parameters

The alarm limits (difference to the set temperature) and the alarm delay (delay until alarm goes off) can be adjusted.

Press for 5 seconds. Display = *rL1*

Display = *rR3*

Display = *rC1*

Display = *rC3*

Display = *rE*

Display = *rH*

Display = *rL*

Display = *AL* Lower alarm limit

Display = *1.0* Temperature difference in °C

Use buttons and to select the desired setting.

Display = *AL*

Display = *AH* Upper alarm limit

Display = *1.0* Temperature difference in °C

Use buttons and to select the desired setting.

Display = *AH*

Display = *Ad*

Display = *60* Alarm delay in minutes

Use buttons and to select the desired setting.

Display = *Ad*

Press for 5 seconds.

The electronic control system will switch back to normal operating mode.

## Audible warning signal

The audible warning signal will sound in certain alarm events. It can be cancelled by pressing button .

### Alarm messages

#### 1. LED flashes

If appears in the display, the appliance has a fault. Consult your nearest customer service point.

#### 2. LED flashes, which reads *HI* or *LO*

The interior is too warm (*HI*) or too cold (*LO*).

The audible warning signal sounds.

#### Note

The alarm parameters can be adjusted. See **Adjusting the alarm parameters**.

#### 3. HACCP flashes

There has been a power cut of some length or the interior was too warm or too cold during a certain period of time.

Up to three alarm events can be stored and called up.

## Door open alarm

When the door is opened, the LED and the temperature display begin to flash.

When the door has been left open for more than 60 seconds, the LED begins to flash, and *dR* and the temperature indication flash alternately in the display.

The audible warning signal sounds.

If the door has to stay open for longer in order to insert items to be cooled, cancel the audible warning signal by pressing button



## Calling up stored alarm events

Display = *HRn*

Scroll through the list using or .

*HRn* Number of temperature alarms

*HR* Last temperature alarm

*HR 1* Last temperature alarm but one

*HR2* Temperature alarm before *HR 1*

*HFn* Number of power cuts

*HF* Last power cut

*HF 1* Last power cut but one

*HF2* Power cut before *HF 1*

Select the required item using the button. Press this button again to return to the list.

Note: You can exit the menu at any time by pressing for 5 seconds.

If no button is pressed within 60 seconds, the electronic control system switches back automatically.

## Example of an alarm query

Situation: HACCP flashes in the display.

 Display = **HA n**

 Display = **0** There has not been an alarm status with a too high or too low temperature. You must switch to display **HF n**.

 Display = **HA n**

 Press this button until **HF n** appears in the display.

 Display = **! 1** power failure has occurred.

 Display = **HF n**

 Display = **HF** Last power failure.

 Display = **Y 10** Year 2010



 Display = **MO5** Month 05 (May)

 Display = **D30** Day 30

 Display = **H23** Hour 23

 Display = **n 14** Minute 14

 Display = **t03** The power failure lasted 3 hours.

Press  +  for 5 seconds. The display will read **rE5**.

The HACCP LED will now light up permanently.

The electronic control system is now ready for the next alarm.

Press  for 5 seconds.

The electronic control system will switch back to normal operating mode.

## Calibrating the control sensor (standard sensor for temperature control)



Possible tolerances of the control sensor (the displayed temperature compared to the actual interior temperature) can be offset with this function.

Press  for 5 seconds. Display = **rC1**

 Display = **rA3**

 Display = **rC1**

 Display = correction value set at the factory

Use buttons  or  to increase or decrease the correction value in 0.1°C increments.

 Display = actual (corrected) interior temperature

 Display = **rC1**

Press  for 5 seconds.

The electronic control system will switch back to normal operating mode.

**Product sensor** (available accessory)

The temperature may be measured or recorded at any point in the interior using the product sensor.

- Connect sensor (see section entitled **External alarm**)

**Activating the sensor**

Press for 5 seconds. Display = **rE1**

Display = **rA3**

Display = **0**

Display = **!**

Display = **rA3**

Press for 5 seconds.

The electronic control system will switch back to normal operating mode.

If **- - -** appears in the display, the product sensor has not been activated.

If **E2** appears in the display, the product sensor has not been connected, or is faulty.

**Calibrating the product sensor**

Possible tolerances of the product sensor (the set temperature compared to the actual interior temperature) can be offset with this function.

Press for 5 seconds. Display = **rE1**

Display = **rA3**

Display = **rC1**

Display = **rC3**

Display = **0.0**

Use buttons or to increase or decrease the correction value in 0.1°C increments.

Display = actual (corrected) product sensor temperature

Press for 5 seconds.

The electronic control system will switch back to normal operating mode.

**Switching the temperature display between control sensor and product sensor**

Press for 5 seconds. Display = **rE1**

Display = **!** (control sensor)

Display = **2** (product sensor)

If the product sensor is activated, AUX appears in the display.



Display = **rE1**

Press for 5 seconds.

The electronic control system will switch back to normal operating mode.

**Changing the network address**

When connecting several appliances via the RS485 interface, each appliance must have its own network address.

Press for 5 seconds. Display = **rE1**

Display = **tC**

Display = **H0**

Display = **!**

Use buttons or to change the network address (**1-207**).

Display = **H0**

Press for 5 seconds.

The electronic control system will switch back to normal operating mode.



## Setting the real time clock

The real time clock is preset (CET). Other time zones or summer/winter time must be adjusted manually.

Press  for 5 seconds. Display = **rt1**



 Display = **tc**

 Display = **4 10** Year 2010

 Display = **10** Set the year by pressing the   buttons.



 = save new setting

 Display = **07** Month (1-12)

 Display = **7** Set the month by pressing the   buttons.



 = save new setting

 Display = **01** Day (1-31)

 Display = **1** Set the day by pressing the   buttons.



 = save new setting

 Display = **03** Days of the week (1 = Monday, 7 = Sunday)

 Display = **3** Set the day of the week by pressing the   buttons.



 = save new setting

 Display = **12** Hour (0-23)

 Display = **12** Set the hour by pressing the   buttons.

 = save new setting

 Display = **48** Minute (0-59)

 Display = **48** Set the minutes by pressing the   buttons.

 = save new setting

Press  for 5 seconds.

The electronic control system will switch back to normal operating mode.

### Note

When **EtC** appears in the display, the real time clock must be reset.

## Resetting the parameters to factory settings

The alarm limits and sensor calibration values can be reset to the factory settings using this function.

Pull out the mains plug.

Keep  pressed and connect the mains plug.

Wait until **bn0** appears in the display!

### CAUTION!

**Do not press the SET button yet! Otherwise all the parameters of the electronic control system will be reset.**

 Display = **bn1**

 Display = **Std**

The electronic control system will switch back to normal operating mode.

## Defrosting

After a longer period of operation a layer of frost or ice can build up on the cooling plates in the freezer compartment. This will increase the energy consumption of the freezer. The cooling plates should therefore be defrosted regularly.

- To defrost, switch the appliance off. Pull out the mains plug.
- Remove the drawers.
- Transfer items to other appliances.
- To speed up the defrosting process put a saucepan of hot but not boiling water on one of the cooling plates.
- Leave the door of the appliance open while defrosting. After defrosting mop up the remaining water with a cloth and clean the appliance.

**Do not use any mechanical devices or other artificial aids for defrosting other than those recommended by the manufacturer.**

## Cleaning

**Before cleaning always switch off the appliance. Pull out the mains plug or switch off or unscrew the fuse.**

- Clean the inside, equipment and outer walls with lukewarm water and a little detergent. Do not use abrasive or acid cleaners or chemical solvents.

**Do not use steam cleaners because of the risk of injury and damage.**

- Ensure that no cleaning water penetrates into the electrical components or ventilation grille.
- The dust should be removed from the refrigeration unit and heat exchanger - metal grid at the back of the appliance - once a year.
- Do not damage or remove the type plate on the inside of the appliance. It is very important for servicing purposes.

### Warning!

**Only clean plastic parts with a damp cloth!  
Risk of electrostatic discharge.**



## Malfunions

You may be able to rectify the following faults by checking the possible causes yourself:

- Appliance does not function:
  - Is the appliance switched on?
  - Is the plug correctly fitted in the mains socket?
  - Is the fuse intact?
- Loud running noise:
  - Is the appliance set up firmly on the floor?
  - Does the appliance cause nearby items of furniture or objects to vibrate? Please note that noises caused by the refrigerant circuit cannot be avoided.
- The temperature is not low enough:
  - Is the temperature setting correct (see "Setting the temperature")?
  - Does the separately installed thermometer show the correct reading?
  - Is the ventilation system working properly?
  - Is the appliance set up too close to a heat source?

- **Etc** appears in the display:
  - Reset the real time clock (see "Setting the real time clock").

If none of the above causes apply and you cannot rectify the fault yourself, contact the nearest customer service department stating the type designation ①, service number ② and appliance number ③ as indicated on the type plate.

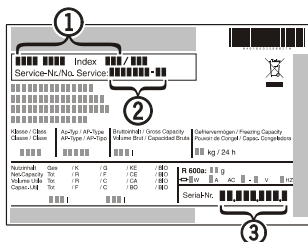

## Shutting your appliance down

If your appliance is to be shut down for any length of time, switch it off and disconnect the plug or switch off or unscrew the fuse. Clean the appliance and leave the door open in order to prevent unpleasant smells.

## External alarm

We recommend connecting the appliance to an external alarm device.

There are various connection options at the back of the appliance.

**The appliance may only be connected to an external alarm device by trained personnel.**

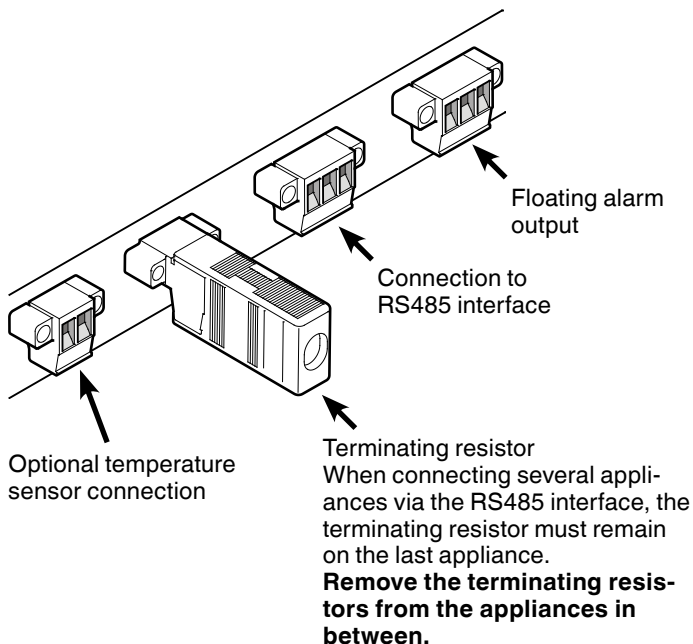
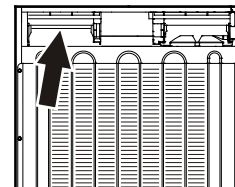

### Note

The connectors are secured with screws. To remove the connectors, undo the left and right screws.

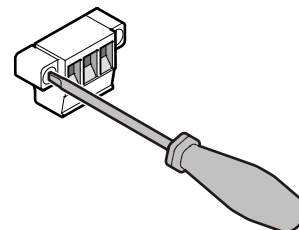

## Floating alarm output

These three contacts can be used to connect the appliance to an optical or acoustic alarm device.

The connection is designed for **250 V / 8 A AC** or **36 V / 8 A DC**.

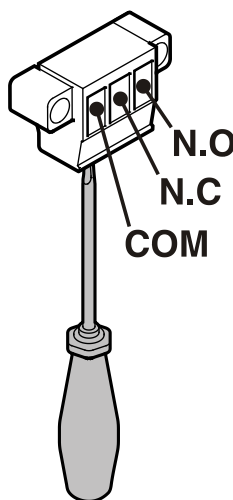

**N.O**  
**Alarm output**  
Connection for a visual warning light or an acoustic alarm signal.

**N.C**  
**Operating light**  
Connection for a control lamp to indicate that the appliance is in normal mode.

**COM**  
**External power supply unit**  
250 V AC (alternating current) or 36 V DC (direct current - positive pole)

## Opening for external temperature sensor Model LGUex 1500

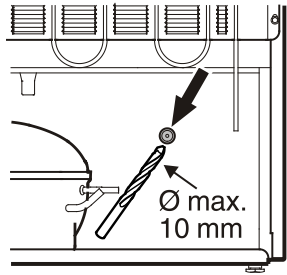

1. Drill marked section on the back of the appliance.

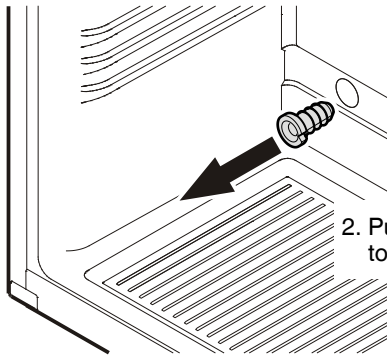

2. Pull out strain relief device (bottom left of interior container).

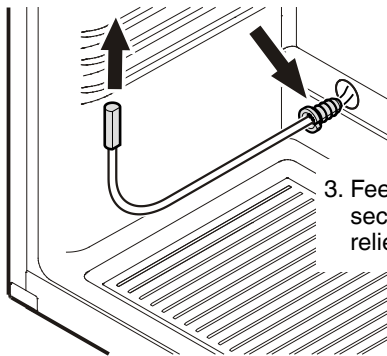

3. Feed sensor through opening and secure sensor cable with strain relief device.

### Important!

Position the sensor at the top of the interior container. The sensor must not come into contact with objects so that only the air temperature is measured.

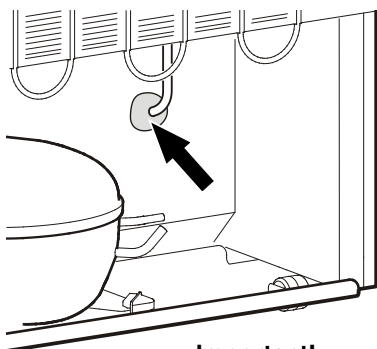

4. Close the sensor cable opening at the back of the appliance with the sealant provided.

### Important!

## Opening for external temperature sensor Model LGex 3410

Remove upper drawer before beginning work.

The condenser must be unscrewed to make the sensor cable opening accessible.

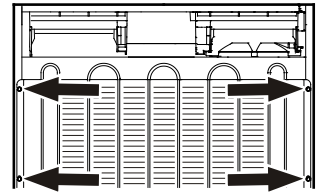

1. Unscrew condenser screws (6 pcs.) and fold out condenser at an angle.

### Important!

Make sure that no pipes are bent.

2. Drill marked section at the back of appliance.

### Important!

Only drill the outer wall of the housing.  
Do not drill too far.

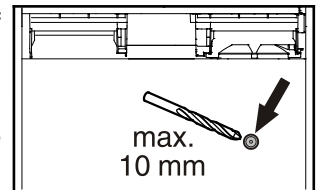

3. Pull out strain relief device (top left of interior container).

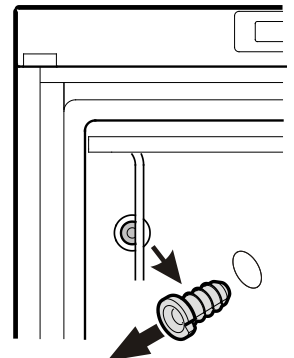

4. Feed sensor through opening and secure sensor cable with strain relief device.

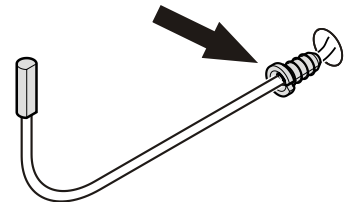

### Important!

Position the sensor at the top of the interior container. The sensor must not come into contact with objects so that only the air temperature is measured.

### Important!

5. Close the sensor cable opening at the back of the appliance with the sealant provided.

6. Screw condenser back on.

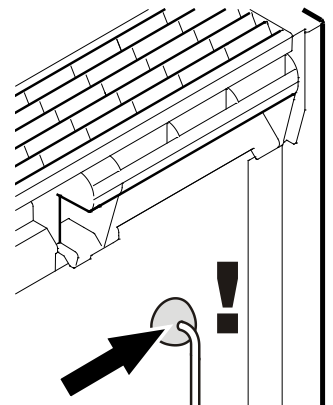

## Changing over door hinges

1. Unscrew the hinge bracket.

**Important:** The door mounting has a spring mechanism enabling the door to close by itself. The hinge bracket turns to the left when the screws are undone.

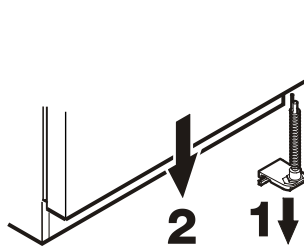

2. Pull the door out at the bottom and lift off.

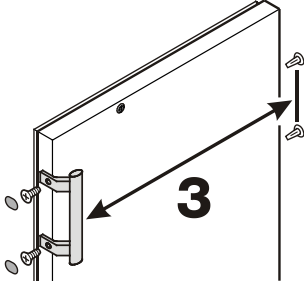

3. Transfer handle and plugs to the opposite side of the door.

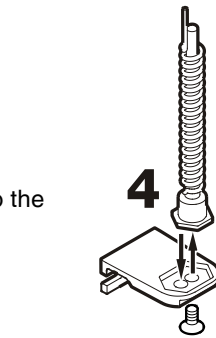

4. Transfer pin on hinge bracket to the opposite side.

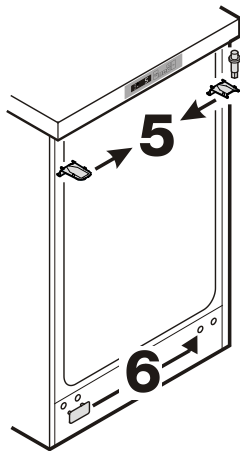

5. Transfer upper hinge components to the opposite side.

6. Transfer cover plate to the opposite side.

7. Mount door on hinge pin and close.

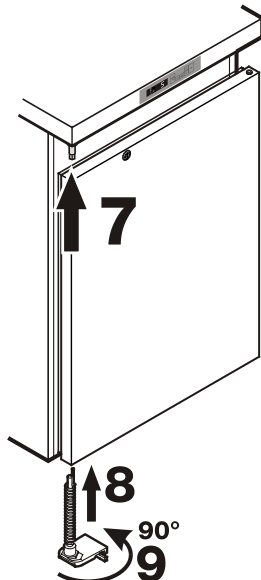

8. Insert hinge bracket in lower door mounting.

9. Turn hinge bracket by 90° - spring is compressed. Screw on hinge bracket.

## Installation dimensions (mm) LGUex 1500

### Version 1

A cross-section of min. 200 cm<sup>2</sup> is required in the worktop for ventilation of the rear of the appliance.

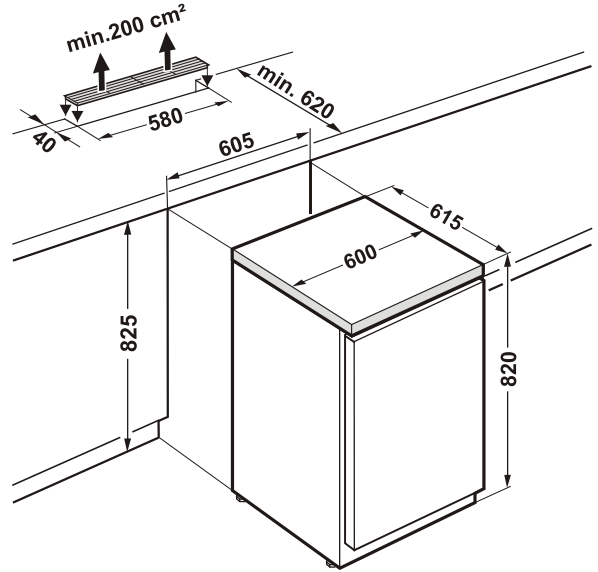

### Version 2

If no ventilation grille is provided in the worktop, the recess must be at least 860 mm high to ensure adequate heat dissipation to the front.

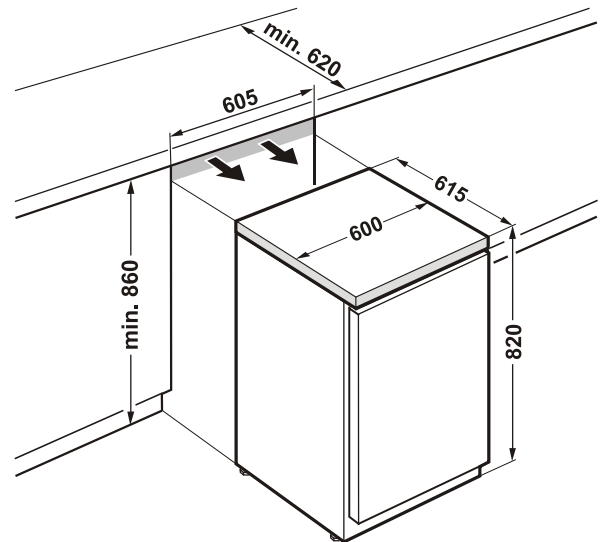

## Veiligheidsslot

Het slot in de deur van het apparaat is met een veiligheidsmechanisme uitgerust.

### Apparaat afsluiten:

- Sleutel in de richting 1 naar binnen duwen.
- Sleutel 90° draaien.

Om het apparaat weer te ontgrendelen moet in dezelfde volgorde te werk worden gegaan.

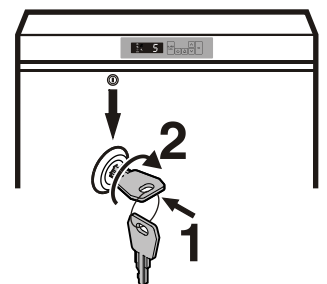

## Free Manuals Download Website

<http://myh66.com>

<http://usermanuals.us>

<http://www.somanuals.com>

<http://www.4manuals.cc>

<http://www.manual-lib.com>

<http://www.404manual.com>

<http://www.luxmanual.com>

<http://aubethermostatmanual.com>

Golf course search by state

<http://golfingnear.com>

Email search by domain

<http://emailbydomain.com>

Auto manuals search

<http://auto.somanuals.com>

TV manuals search

<http://tv.somanuals.com>