

Operating instructions

GB

Combined fridge-freezer with BioFresh compartment for integrated use, door-on-door



131113 **7085462 - 01**

ICBP/ (S)ICBN ... LP

LIEBHERR

Appliance at a glance

Contents

1	Appliance at a glance	2
1.1	Description of appliance and equipment.....	2
1.2	Range of appliance use.....	2
1.3	Conformity.....	3
1.4	Saving energy.....	3
2	General safety information	3
3	Controls and displays	4
3.1	Operating and control elements.....	4
3.2	Temperature display.....	4
4	Putting into operation	5
4.1	Switching on the appliance.....	5
5	Control	5
5.1	Child proofing.....	5
5.2	Door alarm.....	5
5.3	Temperature alarm.....	5
5.4	Refrigerator compartment.....	5
5.5	BioFresh compartment.....	8
5.6	Freezer compartment.....	9
6	Maintenance	11
6.1	Defrosting with NoFrost.....	11
6.2	Manual defrosting.....	11
6.3	Cleaning the appliance.....	12
6.4	Cleaning the IceMaker.....	12
6.5	Customer service.....	12
7	Malfunction	13
8	Decommissioning	14
8.1	Switching off the appliance.....	14
8.2	Taking the appliance out of service.....	14
9	Disposing of the appliance	14

The manufacturer works constantly on the further development of all the types and models. Therefore please understand that we have to reserve the right to make design, equipment and technical modifications.

To get to know all the benefits of your new appliance, please read the information contained in these instructions carefully.

The instructions apply to several models. Differences may occur. Text relating only to specific appliances is marked with an asterisk (*).

Instructions for action are marked with a ►, the results of action are marked with a ▷.

1 Appliance at a glance

1.1 Description of appliance and equipment

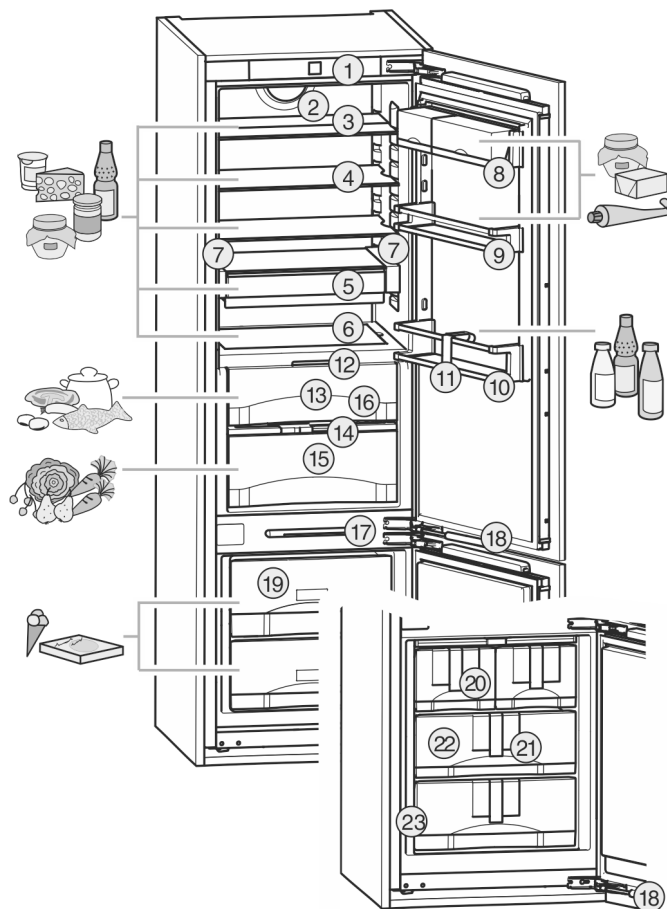

Fig. 1

- | | |
|---|--|
| (1) Operating and control elements | (13) DrySafe |
| (2) Fan | (14) Humidity control plate |
| (3) Shelf, sectioned | (15) HydroSafe |
| (4) Shelf | (16) Drain hole |
| (5) VarioSafe* | (17) LED lighting, freezer compartment |
| (6) Adjustable bottle shelf | (18) Soft stop mechanism |
| (7) LED light column, double sided | (19) Freezer compartment drawer |
| (8) Package rack | (20) IceMaker* |
| (9) Can rack* | (21) Information system* |
| (10) Bottle rack | (22) Cold storage accumulators |
| (11) Bottle holder | (23) Type plate |
| (12) LED lighting, BioFresh compartment | |

Note

- Place food inside the appliance as shown in the diagram. This allows the appliance to save energy during operation.
- Shelves, drawers and baskets are arranged for optimum energy efficiency on delivery.

1.2 Range of appliance use

The appliance is suitable solely for cooling food in a domestic environment or similar. This includes use in, for example

- in staff kitchenettes, bed and breakfast establishments,
- by guests in country homes, hotels, motels and other forms of accommodation,
- in catering and similar services in the wholesale trade

Use the appliance solely as is customary within a domestic environment. All other types of use are inadmissible. The appliance is not suitable for storing and cooling medicines, blood plasma, laboratory preparations or similar substances and products covered by the 2007/47/EC Medical Devices Directive. Misuse of the appliance can result in the stored products suffering harm or perishing. Furthermore, the appliance is not suitable for operation in potentially explosive atmospheres.

The appliance is set to operate within specific ambient temperature limits according to its climate rating. The correct climate rating for your appliance is indicated on the type plate.

Note

► Compliance with the ambient temperatures indicated is required, otherwise the cooling performance is reduced.

Climate rating	for ambient temperatures of
SN	10 °C to 32 °C
N	16 °C to 32 °C
ST	16 °C to 38 °C
T	16 °C to 43 °C

1.3 Conformity

The refrigerant circuit is tested for leakage. When built-in the appliance complies with the relevant safety regulations and EC Directives 2006/95/EC, 2004/108/EC, 2009/125/EC and 2010/30/EU.

The BioFresh compartment satisfies the requirements of a chill compartment to EN ISO 15502.

Note for test institutions:

Tests are to be carried out according to the applicable standards and guidelines. Preparation and testing of the appliances must be carried out taking the **manufacturer's loading plans** and the **notes in the operating manual** into account.

1.4 Saving energy

- Always ensure good ventilation. Do not cover ventilation openings or grille.
- Do not place appliance in areas of direct sunlight or next to a stove, heater or similar object.
- The energy consumption depends on the installation conditions, e.g. the ambient temperature (see 1.2).
- Keep the time the appliance is open to a minimum.
- The lower the temperature setting, the higher the power consumption.
- Store food logically. (see Appliance at a glance).

- Ensure that all food is well packed and covered for storage. This will prevent frost from forming.
- Remove food as needed in order that it does not warm too much.
- First cool warm food to room temperature before storing it.
- Defrost frozen food in the refrigerator.
- If there is a thick layer of frost in the appliance: defrost the appliance.*
- Use the vacation function for longer vacation periods (see 5.4.4).

2 General safety information

Danger for the user:

- This appliance can be used by children of 8 years old and over, and also by persons with restricted physical, sensory or mental capacity or lack of experience and knowledge, if they are supervised or have been instructed on safe use of the appliance and understand the resulting risks. Children must not be allowed to play with the appliance. Cleaning and user maintenance must not be carried out by children without supervision.
- When disconnecting the appliance from the supply, always take hold of the plug. Do not pull the cable.
- In the event of a fault pull out the mains plug or deactivate the fuse.
- Do not damage the mains power cable. Do not operate the appliance with a defective mains power cable.
- Have any repairs to or intervention in the appliance, and any change of the mains power cable, carried out by the customer service only or by other specialised personnel trained for the purpose.
- Only install, connect and dispose of the appliance according to the instructions.
- Only use the appliance when it is installed.
- Please keep these instructions in a safe place and pass them on to any subsequent owners.
- All repairs to and intervention in the IceMaker may be carried out only by service personnel or by other skilled personnel trained for the purpose.*
- The manufacturer is not liable for damage caused by a faulty fixed water connection.*
- Special-purpose lamps (incandescent lamps, LEDs, fluorescent tubes) in the appliance serve to illuminate the appliance interior and are not suited for room illumination.

Fire hazard:

- The refrigerant R 600a is environmentally friendly but flammable. Escaping refrigerant may ignite.
 - Do not damage the refrigerant circuit pipes.

* Depending on model and options

Controls and displays

- Do not allow naked flames or ignition sources to enter the appliance.
 - Do not use any electrical appliances in the interior (e.g. steam cleaners, heaters, ice cream maker etc.).
 - If refrigerant escapes: remove any naked flames or sources of ignition from the leakage area. Ventilate the room well. Notify the after-sales service.
- Do not store explosives or sprays using combustible propellants such as butane, propane, pentane, etc. in the appliance. To identify these spray cans, look for the list of contents printed on the can, or a flame symbol. Gases possibly escaping may ignite due to electrical components.
 - Please be sure to store alcoholic drinks or other packaging containing alcohol in tightly closed containers. Any alcohol that leaks out may be ignited by electrical components.

Danger of tipping and falling:

- Do not misuse the plinth, drawers, doors etc. as a step or for support. This applies particularly to children.

Danger of food poisoning:

- Do not consume food which has been stored too long.

Danger of frostbite, numbness and pain:

- Avoid lasting skin contact with cold surfaces or refrigerated/frozen food or take protective steps, e.g. wear gloves. Do not consume ice cream, water ice or ice cubes immediately and do not consume them too cold.

Danger of injury and damage:

- Hot steam can lead to injury. Do not use electrical heating or steam cleaning equipment, open flames or defrosting sprays to defrost.
- Do not use sharp implements to remove the ice.

Risk of crushing

- Do not reach into the soft stop mechanism. Fingers may be trapped when the door is closed.

Please observe the specific information in the other sections:

	DANGER	identifies a situation involving direct danger which, if not obviated, may result in death or severe bodily injury.
	WARNING	identifies a dangerous situation which, if not obviated, may result in death or severe bodily injury.

	CAUTION	identifies a dangerous situation which, if not obviated, may result in minor or medium bodily injury.
	NOTICE	identifies a dangerous situation which, if not obviated, may result in damage to property.
	Note	identifies useful information and tips.

3 Controls and displays

3.1 Operating and control elements

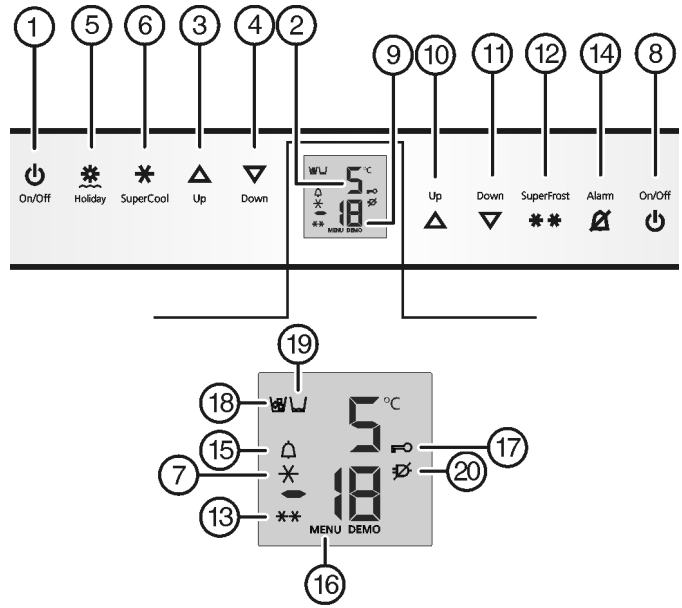

Fig. 2

- | | |
|--|--|
| (1) Refrigerator compartment On/Off button | (11) Freezer compartment Down setting button |
| (2) Refrigerator compartment temperature display | (12) SuperFrost button |
| (3) Refrigerator compartment Up setting button | (13) SuperFrost symbol |
| (4) Refrigerator compartment Down setting button | (14) Alarm button |
| (5) Holiday button | (15) Alarm symbol |
| (6) SuperCool button | (16) Menu symbol |
| (7) SuperCool symbol | (17) Child lock symbol |
| (8) Refrigerator compartment On/Off button | (18) IceMaker symbol* |
| (9) Freezer compartment temperature display | (19) Water tank symbol* |
| (10) Freezer compartment Up setting button | (20) Power failure symbol |

3.2 Temperature display

The following are displayed in normal operation:

- the warmest freezing temperature
- the average cooling temperature

The freezer compartment temperature display flashes:

- the temperature setting is being changed
- after switch-on the temperature is not yet cold enough
- the temperature has risen several degrees

Dashes flash in the display:

- the freezer temperature is above 0 °C.

The following displays indicate malfunction. Possible causes and corrective action (see Malfunction).

- **F0** to **F9**
- **FE***
- The power failure symbol  shines.

4 Putting into operation

4.1 Switching on the appliance

Note

- ▶ To switch on the entire appliance it is necessary only to switch on the freezer compartment.

Switch on the appliance approx. 2 hours before adding frozen food for the first time.

Do not load food to be frozen before the temperature display reads -18 °C.



4.1.1 Switching on the freezer compartment

- ▶ Open the door.
- ▶ Press On/Off button, freezer compartment *Fig. 2 (8)*.
- ▷ The temperature display of the refrigerator compartment indicates the current temperature inside.
- ▷ The temperature display of the freezer compartment and the alarm symbol flash until the temperature is sufficiently low. If the temperature is above 0 °C, dashes flash. If it is below, the current temperature flashes.

4.1.2 Switching on refrigerator and BioFresh compartment

If the refrigerator compartment was switched off (e.g. during an extended absence like holidays), it can be switched back on separately.

- ▶ Open the door.
- ▶ Press On/Off button, refrigerator compartment *Fig. 2 (1)*.
- ▷ The interior light is on when the door is opened.
- ▷ The temperature display shines. Refrigerator and BioFresh compartment are switched on.

5 Control

5.1 Child proofing

The child-proofing function enables you to make sure that the appliance is not inadvertently switched off by playing children.



5.1.1 Setting the child lock function

- ▶ To activate the setting mode: press SuperFrost button *Fig. 2 (12)* for about 5 s.
- ▷ **c** flashes on the display.
- ▷ The menu symbol *Fig. 2 (16)* shines.
- ▶ Briefly press the SuperFrost button *Fig. 2 (12)* to confirm.
- When **cl** is indicated in the display:
- ▶ To activate the child lock, briefly press the SuperFrost button *Fig. 2 (12)*.



- ▷ The child lock symbol *Fig. 2 (17)* shines. **c** flashes in the display.
- When **cl** is indicated in the display:

- ▶ to deactivate the child lock, briefly press the SuperFrost button *Fig. 2 (12)*.

- ▷ The child lock symbol *Fig. 2 (17)* goes out. **c** flashes in the display.
- ▶ To deactivate the set-up mode: press On/Off button, freezer compartment *Fig. 2 (8)*.

-or-

- ▶ Wait for 5 minutes.
- ▷ The temperature is indicated again in the temperature display.

5.2 Door alarm

For refrigerator/BioFresh compartment and freezer compartment

If the door is open for longer than 60 seconds, the audible warning will sound.

The audible alarm is automatically silenced when the door is closed.



5.2.1 Muting the door alarm

The audible alarm can be muted when the door is open. The sound switch-off function is active as long as the door is left open.

- ▶ Press alarm button *Fig. 2 (14)*.
- ▷ The door alarm is silenced.

5.3 Temperature alarm

The audible alarm sounds if the freezer temperature is not cold enough.

The temperature display and the alarm symbol *Fig. 2 (15)* flash at the same time.



The cause of the temperature being too high may be:

- warm fresh food was placed inside
- too much warm ambient air flowed in when rearranging and removing food
- power failure for some time
- the appliance is faulty

The audible alarm is automatically silenced, the alarm symbol *Fig. 2 (15)* goes out and the temperature display stops flashing when the temperature is sufficiently cold again.

If the alarm status persists: (see Malfunction).

Note

Food may be spoilt if the temperature is not cold enough.

- ▶ Check the quality of the food. Do not consume spoiled food.

5.3.1 Muting the temperature alarm

The audible alarm can be muted. When the temperature is sufficiently cold again, the alarm function is active again.

- ▶ Press alarm button *Fig. 2 (14)*.
- ▷ The audible alarm is silenced.

5.4 Refrigerator compartment

The natural circulation of air in the refrigerator compartment results in zones differing in temperature. It is coldest directly above the plate separating off the BioFresh zone and at the rear wall. It is warmest at the top front of the compartment and in the door.

Control

5.4.1 Food refrigeration

Note

The energy consumption increases and the cooling performance decreases if the ventilation is inadequate.

- ▶ Always keep the air slits of the fan free.
- ▶ Place butter and preserves in the upper area and in the door (see Appliance at a glance).
- ▶ Use recyclable plastic, metal, aluminium and glass containers and cling film for wrapping.
- ▶ Always store liquids and food which is subject to odour or taste transfer in closed containers or cover them.
- ▶ Foods which give off a large amount of ethylene gas and delicate foods, such as fruit, vegetables, salad, should always be stored separately or wrapped so as not to reduce the storage life; e.g. do not store tomatoes together with kiwis or cabbage.
- ▶ Use the front area of the refrigerator compartment floor only for briefly putting down cooled products, e.g. when rearranging and sorting. However do not leave cooled products there otherwise they may be pushed back or tipped over when the door is closed.
- ▶ Do not store food too close together to enable good air circulation.

5.4.2 Setting the temperature

The temperature depends on the following factors:

- the frequency of opening the door
- the room temperature of the installation location
- the type, temperature and quantity of the food

The temperature can be set from 9 °C to 3 °C, the recommended temperature is 5 °C.

Note

If the temperature is to be colder than 3 °C:

- ▶ set the cooling temperature to 3 °C.
- ▶ Set the BioFresh temperature to a value between **b4** (slightly colder) and **b1** (coldest) (see 5.5)

- ▶ For a higher temperature setting: press Up button, refrigerator compartment *Fig. 2 (3)*.
- ▶ For a lower temperature setting: press Down button, refrigerator compartment *Fig. 2 (4)*.
- ▷ When the button is pressed for the first time, the previously set value is indicated, flashing, in the refrigerator compartment temperature display.
- ▶ To change the temperature in 1 °C steps: briefly press the button.
- ▶ To change the temperature continuously: hold down the button.
- ▷ The value is displayed flashing during the setting operation.
- ▷ The actual temperature is displayed about 5 s after the last press of a button. The temperature slowly adjusts to the new value.

5.4.3 SuperCool

With SuperCool you switch to the highest cooling performance to reach lower cooling temperatures. Use SuperCool, to rapidly cool large amounts of food.



The SuperCool function uses slightly more energy.

Cooling with SuperCool

- ▶ Briefly press SuperCool button *Fig. 2 (6)*.
- ▷ The SuperCool symbol *Fig. 2 (7)* lights up in the display.
- ▷ The cooling temperature drops to the coldest value. SuperCool is activated.

- ▷ SuperCool is automatically deactivated after 12 hours. The appliance continues to operate in the energy-saving, normal mode.

To prematurely deactivate SuperCool

- ▶ Briefly press SuperCool button *Fig. 2 (6)*.
- ▷ The SuperCool symbol *Fig. 2 (7)* goes out in the display.
- ▷ SuperCool is deactivated.

5.4.4 Holiday mode

The holiday mode saves energy and prevents odour from occurring when the door of the refrigerator compartment stays closed for a lengthy period.



The freezer compartment remains in operation in the holiday mode.

Activating the holiday mode

- ▶ Remove all the food from the refrigerator and BioFresh compartment, otherwise they will perish..
- ▶ Press the holiday button *Fig. 2 (5)* for 3 sec.



- ▷ The holiday mode is activated. The display indicates **Ho**.

Deactivating the holiday mode

- ▶ Briefly press the holiday button *Fig. 2 (5)*.
- ▷ The holiday mode is deactivated.
- ▷ The current cooling temperature is indicated in the display.

5.4.5 Shelves

Relocating the shelves

The shelves have stops preventing them from being unintentionally pulled out.

- ▶ Lift the shelf and draw it out forwards.
- ▶ Re-insert shelves at the required height. The stops must face downwards and lie behind the front shelves.

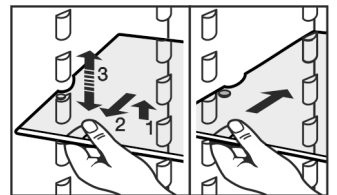

Dismantling shelves

- ▶ The shelves can be dismantled for cleaning.

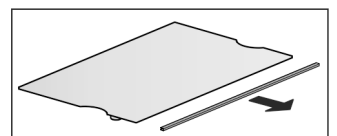

5.4.6 Using the sectioned shelf

- ▶ Slide the sectioned shelf under, as shown in the illustration.

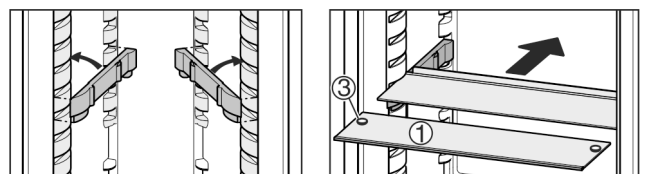
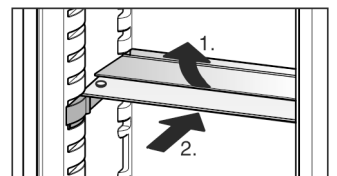

Fig. 3

- ▶ The glass plate (1) with pull-out stops must be at the front so that the stops (3) face downwards.

5.4.7 Using adjustable bottle shelf

At the base of the refrigerator compartment, the integrated bottle shelf or alternatively the glass shelf can be used:

- ▶ To use the bottle shelf: store the glass shelf compactly under the bottle shelf.
- ▶ Place the bottles with the base pointing backwards facing the rear wall. If the bottles project beyond the bottle shelf:
- ▶ set the lower door rack one position higher.

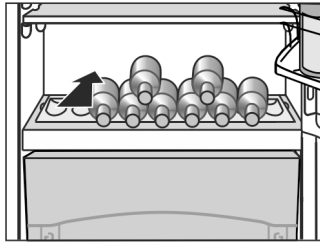

The boxes can be removed and placed on the table as a single unit.

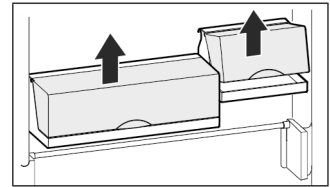

Either one or both the boxes can be used. If particularly tall bottles are to be stored, hang only a single box above the bottle rack.

- ▶ Re-positioning the boxes: Lift them for removal and re-position them as required.

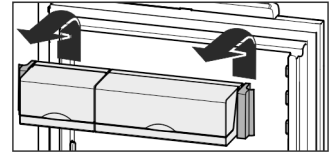

5.4.8 VarioSafe*

The VarioSafe provides space for small items of food and packages, tubes and jars.

Using VarioSafe*

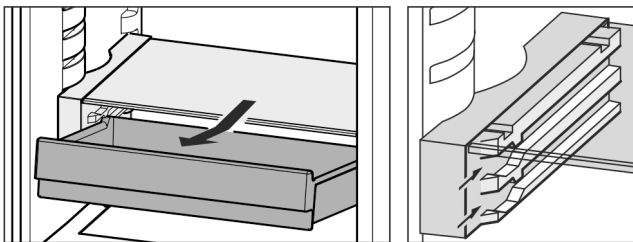
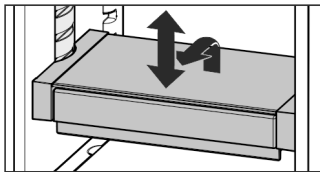

Fig. 4

- ▶ The VarioSafe drawer can be taken out and pushed in at two different heights.
- ▶ The VarioSafe can also be height-adjusted as a whole.



Dismantling door racks

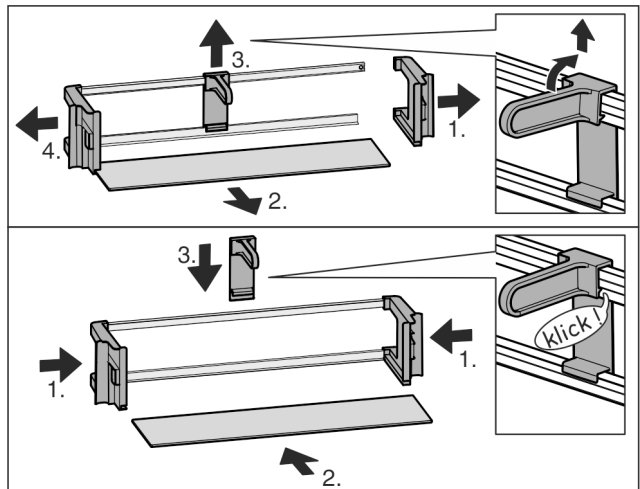

Fig. 7

Dismantling VarioSafe*

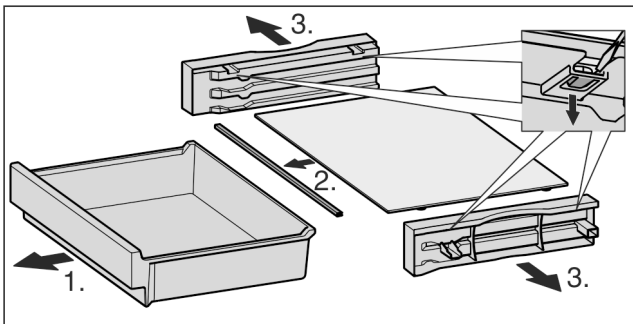

Fig. 5

- ▶ The VarioSafe can be dismantled for cleaning.

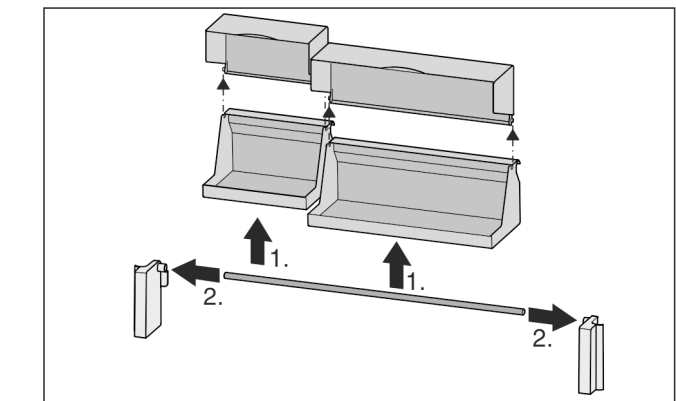

Fig. 8

- ▶ The door racks can be dismantled for cleaning.

5.4.9 Door racks

Moving the storage rack

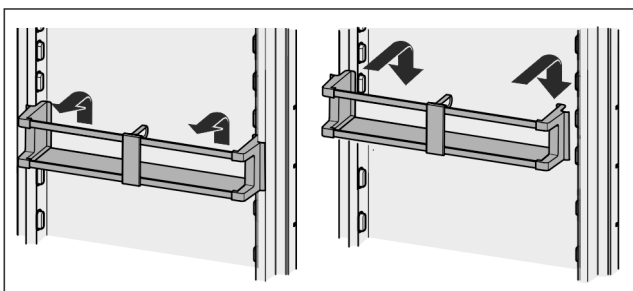
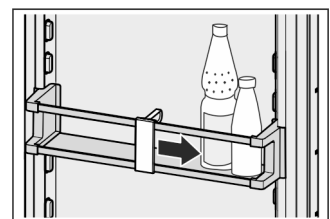

Fig. 6

5.4.10 Using the bottle holder

- ▶ To avoid the bottles tipping over, push the bottle holder along.



Control

5.5 BioFresh compartment

The BioFresh compartment allows some types of fresh food to be stored up to three times longer than in conventional refrigerators, without compromising quality.

For food with an indicated best before date, the date specified on the packaging always applies.



5.5.1 DrySafe

The DrySafe is suitable for storing dry or wrapped food (e.g. dairy products, meat, fish, sausages). A relatively dry storage climate is established here.

5.5.2 HydroSafe

The HydroSafe at the moist setting is suited for storing unwrapped salad, vegetables and fruit with high inherent moisture. When the drawer is well filled, a dewy climate with up to 90% humidity is established. The humidity in the compartment depends on the moisture content of the food stored and on the opening frequency. You can set the humidity yourself.

5.5.3 Setting the humidity in the HydroSafe

- ▶  Low humidity: move the regulator to the left.
- ▶  High humidity: move the regulator to the right.

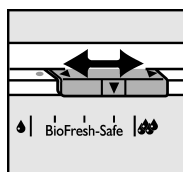

5.5.4 Storing food

Note

- ▶ Vegetables sensitive to cold, such as cucumbers, aubergines, semi-ripe tomatoes, zucchinis and all tropical fruits sensitive to cold, do not belong in the BioFresh compartment.
- ▶ To prevent food spoilage due to transfer of germs: Store unwrapped animal and vegetable products separate from one another in the drawers. This also applies to different sorts of meat.
If food has to be stored together due to lack of space:
 - ▶ wrap the food.

5.5.5 Storage times

Standard values for storage time at low humidity			
Butter	up to	90	days
Hard cheese	up to	110	days
Milk	up to	12	days
Sausage, cold meat	up to	9	days
Poultry	up to	6	days
Pork	up to	7	days
Beef	up to	7	days
Game	up to	7	days

Note

- ▶ Please note that protein-rich food deteriorates faster, i.e. shellfish and crustaceans deteriorate faster than fish, fish faster than meat.

Standard values for storage time at high humidity			
Vegetables, salad			

Standard values for storage time at high humidity			
Artichokes	up to	14	days
Celery	up to	28	days
Cauliflower	up to	21	days
Broccoli	up to	13	days
Chicory	up to	27	days
Lamb's lettuce	up to	19	days
Peas	up to	14	days
Kale	up to	14	days
Carrots	up to	80	days
Garlic	up to	160	days
Kohlrabi	up to	55	days
Lettuce	up to	13	days
Herbs	up to	13	days
Leek	up to	29	days
Mushrooms	up to	7	days
Radishes	up to	10	days
Brussels sprouts	up to	20	days
Asparagus	up to	18	days
Spinach	up to	13	days
Savoy cabbage	up to	20	days
Fruit			
Apricots	up to	13	days
Apples	up to	80	days
Pears	up to	55	days
Blackberries	up to	3	days
Dates	up to	180	days
Strawberries	up to	7	days
Figs	up to	7	days
Blueberries	up to	9	days
Raspberries	up to	3	days
Currants	up to	7	days
Sweet cherries	up to	14	days
Kiwis	up to	80	days
Peaches	up to	13	days
Plums	up to	20	days
Cranberries	up to	60	days
Rhubarb	up to	13	days
Gooseberries	up to	13	days
Grapes	up to	29	days

5.5.6 Adjusting the temperature in the BioFresh compartment

The temperature is regulated automatically. At a temperature of 5 °C in the refrigerator compartment, the temperature in the BioFresh compartment is between 0 °C and 3 °C.

You can adjust the temperature slightly colder or warmer. The temperature can be adjusted from **b1** (coldest temperature) to **b9** (warmest temperature). The presetting is **b5**. With the **b1** to **b4** values, the temperature can drop below 0 °C and therefore food can freeze slightly as a result.

- ▶ To activate the setting mode: press the SuperFrost button *Fig. 2 (12)* for about 5 s.
- ▷ The menu symbol *Fig. 2 (16)* shines.
- ▷ **c** flashes on the display.
- ▶ Press the Up setting button, freezer compartment *Fig. 2 (10)* the number of times required for **b** to flash in the display.
- ▶ To confirm: briefly press the SuperFrost button.
- ▶ To set the temperature higher: press Up button, freezer compartment *Fig. 2 (10)*.
- ▶ To set the temperature lower: press Down button, freezer compartment *Fig. 2 (11)*.
- ▶ To confirm: press SuperFrost button.
- ▷ The temperature slowly adjusts to the new value.



- ▶ To deactivate the setting mode: press On/Off button, freezer compartment *Fig. 2 (8)*.

-or-

- ▶ Wait for 5 minutes.

- ▷ The temperature is indicated again in the temperature display.

5.5.7 Drawers with cushioners

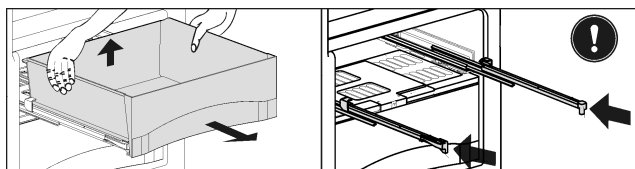

Fig. 9

- ▶ Pull out the drawer, lift it at the back and draw it forwards for removal.
- ▶ Push the rails in again!

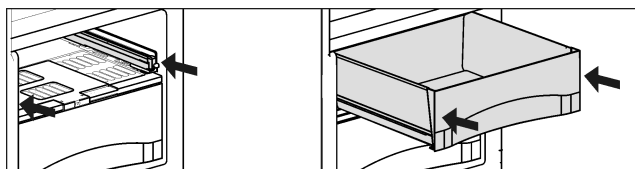

Fig. 10

- ▶ Push the rails in.
- ▶ Attach the drawer and push it in until it engages audibly at the back.

5.5.8 Humidity control plate

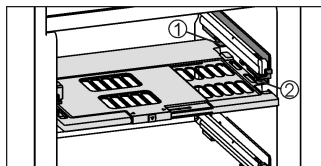

Fig. 11

- ▶ To remove the humidity control plate: Having removed the drawers, carefully draw the plate forwards and lower it for removal.
- ▶ To insert the humidity control plate: Insert the cover mouldings of the plate into the rear holder *Fig. 11 (1)* from underneath and engage them in the holder *Fig. 11 (2)* at the front.

5.6 Freezer compartment

You can store frozen food, make ice cubes and freeze fresh food in the freezer compartment.

5.6.1 Freezing food

The rating plate indicates the maximum quantity of fresh food you can freeze within 24 hours (see Appliance at a glance) under "Freezing capacity ... kg/24h".

The maximum load of frozen food for the drawers is 25 kg each and for the shelves 35 kg each.

A vacuum is generated after the door is closed. After closing the door, wait for about 1 minute and then it opens more easily.



CAUTION

Risk of injury due to broken glass!

Bottles and cans containing drinks may burst when being frozen. This applies particularly to sparkling drinks.

- ▶ Do not freeze bottles and cans containing drinks!

In order that the food is rapidly frozen through to the core, do not exceed the following quantities per pack:

- Fruit, vegetables up to 1 kg
- Meat up to 2.5 kg
- ▶ Pack the food in portions in freezer bags, reusable plastic, metal or aluminium containers.

5.6.2 Thawing food

- in the refrigerator compartment
- at room temperature
- in a microwave oven
- in a conventional or fan oven
- ▶ Remove only as much food as is required. Use thawed food as quickly as possible.
- ▶ Food once thawed should be re-frozen only in exceptional cases.

5.6.3 Setting the temperature in the freezer compartment

The appliance is pre-set for normal operation.

The temperature can be set from -15 °C to -26 °C, the recommended temperature is -18 °C.

- ▶ To set the temperature higher: press Up button, freezer compartment *Fig. 2 (10)*.
- ▶ To set the temperature lower: press Down button, freezer compartment *Fig. 2 (11)*.
- ▷ When the button is pressed the first time, the previous value is indicated in the temperature display of the freezer compartment.
- ▶ To change the temperature in 1 °C steps: briefly press the button.

-or-

- ▶ To change the temperature continuously: hold down the button.

- ▷ The value is displayed flashing during the setting operation.
- ▷ The actual temperature is displayed approx. 5 seconds after the button is last pressed. The temperature gradually adjusts to the new value.

5.6.4 SuperFrost

With this function you can freeze fresh food quickly through to the core. The appliance operates with maximum refrigeration. The noise of the refrigeration unit may be temporarily louder as a result. ❄ ❄

In addition, frozen food already in storage is given a "cold reserve". The food stays frozen longer as a result when you defrost the appliance.*

The maximum amount of fresh food which can be frozen in 24 h is indicated on the type plate under "freezing capacity ... kg/24h". This amount varies according to the model and climate rating.

Control

You have to activate SuperFrost in good time, depending on how much fresh food is to be frozen: about 6 hours before placing the food inside in case of small amounts and about 24 hours in advance in case of the maximum amount of food to be frozen.

Wrap produce and spread it out as far as possible. Do not allow produce to be frozen to touch produce that is already frozen to prevent the latter thawing.

You do not have to activate SuperFrost in the following cases:

- when placing frozen food in the freezer
- when freezing up to approx. 2 kg fresh food daily

Freezing with SuperFrost

- ▶ Briefly press the SuperFrost button *Fig. 2 (12)* once.
- ▷ The SuperFrost symbol *Fig. 2 (13)* shines.
- ▷ The freezing temperature drops, the appliance operates with the maximum cooling capacity.
 - For a smaller quantity of produce to be frozen:
 - ▶ wait approx. 6 h.
 - ▶ Appliances with NoFrost: place wrapped produce in the top drawers.
 - ▶ Appliances without NoFrost: place wrapped produce in the bottom drawers.
- For the maximum quantity of produce to be frozen:
 - ▶ wait approx. 24 h.
 - ▶ Appliances with NoFrost: remove top drawers and place produce directly on the top shelves.
 - ▶ Appliances without NoFrost: remove bottom drawer and place produce directly in the appliance so that it touches the base or sides.
- ▷ SuperFrost is automatically deactivated. Depending on the quantity placed inside, after 30 h at the earliest, 65 h at the latest.
- ▷ The SuperFrost symbol *Fig. 2 (13)* extinguishes once freezing is completed.
- ▶ Place produce in the drawers and push the latter back in again.
- ▷ The appliance continues to operate in the energy-saving, normal mode.

5.6.5 Drawers

Note

The energy consumption increases and the cooling performance decreases if there is insufficient ventilation.

For appliances with NoFrost:

- ▶ Leave the bottom drawer in the appliance!
- ▶ Always keep the air slits of the fan free at the rear wall!

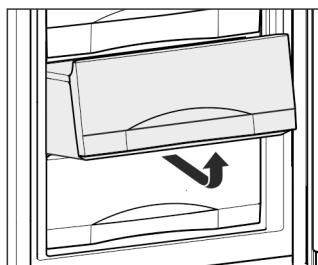

- ▶ To store frozen food directly on the shelves: pull the drawer forwards and lift it out.

5.6.6 Shelves

- ▶ To remove the shelf: lift up at the front and pull out.
- ▶ To put the shelf back: simply push in as far as it will go.

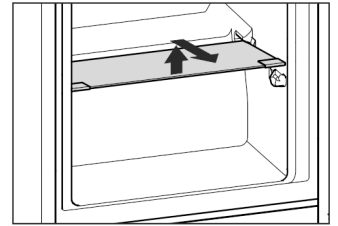

5.6.7 VarioSpace

Apart from being able to remove the drawers, you can also remove the shelves, creating space for large items of frozen food. Poultry, meat, large pieces of game and high bakery products can be frozen in one piece and prepared.

- ▶ The maximum load of frozen food for the drawers is 25 kg each and for the shelves 35 kg each.

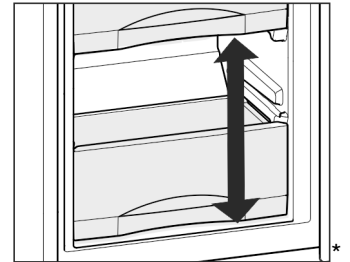

5.6.8 Information system*

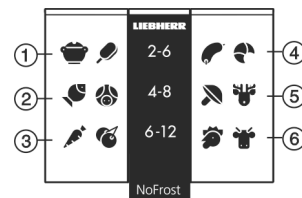

Fig. 12

- (1) Ready meals, ice cream
- (2) Pork, fish
- (3) Fruit, vegetables
- (4) Sausage, bread
- (5) Game, mushrooms
- (6) Poultry, beef / veal

The figures indicate the storage time in months for several types of frozen food in each case. Storage times given are guide times.

5.6.9 Cold storage accumulators

The cold storage accumulators prevent the temperature from rising too fast in the event of power failure.

Using cold storage accumulators*

- ▶ Place the frozen cold storage accumulators on the frozen food in the upper front area of the freezer compartment.

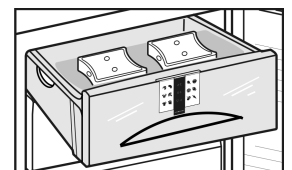

Using cold storage accumulators*

- ▶ Freeze and store the cold storage accumulators in the ceiling of the freezer compartment.

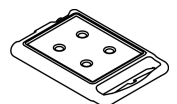

With the top drawer removed:

- ▶ to insert cold storage accumulators: slide cold storage accumulator into the top back of the freezer compartment ceiling and snap into place at the front.

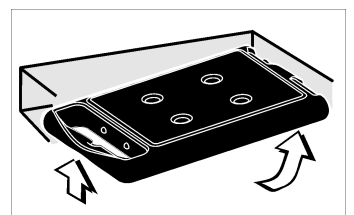

With the top drawer removed:

- ▶ to remove cold storage accumulators: take hold of the cold storage accumulator at the side and press it down for removal.

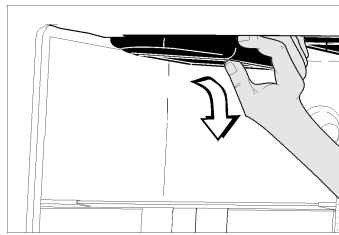

5.6.10 IceMaker*

The IceMaker is in the top drawer of the freezer compartment. The drawer is marked "IceMaker".

Make certain that the following conditions are met:

- The appliance is level.
- The appliance is connected.
- The freezer compartment is switched on.
- The IceMaker is connected to the water supply.

Switching on the IceMaker*

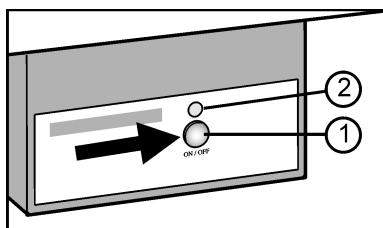

Fig. 13

- ▶ Pull out the drawer.
- ▶ Press the On/Off button Fig. 13 (1) so that the LED Fig. 13 (2) shines.
- ▶ Push in the drawer.
- ▷ The IceMaker symbol Fig. 2 (18) shines.

Note

- ▶ The IceMaker produces ice cubes only if the drawer is fully closed.

Producing ice cubes*

The production capacity depends on the freezer temperature. The lower the temperature, the more ice cubes can be produced in a specific period.

The ice cubes drop from the IceMaker into the drawer. When a certain filling level has been reached, no further ice cubes are produced. The IceMaker does not fill the drawer right up to the brim.

If large quantities of ice cubes are needed, the complete IceMaker drawer can be exchanged for the adjacent drawer. When the drawer is closed, the IceMaker automatically recommences production.

Once the IceMaker has been switched on for the first time, it may take up to 24 hours until the first ice cubes are produced.

Note

When the appliance is used for the first time and if it has been out of use for a long time, particles may collect in the IceMaker and/or water conduit.

- ▶ Therefore do not use or consume the ice cubes made in the first 24 hours.

Setting the water intake time*

The opening time of the IceMaker valve can be set if, for example, the water pressure in the pipe is too low or too high.

The water intake time can be set in stages from **E1** (short intake time) to **E8** (long intake time). The intake is preset at **E3**.

- ▶ To activate the setting mode: press the SuperFrost button Fig. 2 (12) for about 5 s.
- ▷ The display indicates **c**.

- ▷ The menu symbol Fig. 2 (16) shines.
- ▶ Using the Up setting button, freezer compartment Fig. 2 (10) and Down setting button, freezer compartment Fig. 2 (11) select **E**.
- ▶ To confirm: briefly press the SuperFrost button Fig. 2 (12).
- ▶ To increase the water intake time: press the Up setting button, freezer compartment Fig. 2 (10).
- ▶ To reduce the water intake time: press the Down setting button, freezer compartment Fig. 2 (11).
- ▶ To confirm: press the SuperFrost button Fig. 2 (12).
- ▶ To deactivate the setting mode: press the On/Off button, freezer compartment Fig. 2 (8).
- ▷ The temperature is indicated again in the temperature display.

Switching off the IceMaker*

If no ice cubes are needed, the IceMaker can be switched off independently of the freezer compartment.

When the IceMaker is switched off, the IceMaker drawer can also be used for freezing and storing food.

- ▶ Press the On/Off button for about 1 second until the LED goes out.
- ▷ The IceMaker symbol Fig. 2 (18) goes out.
- ▶ Clean the IceMaker.
- ▷ This ensures that no water or ice remains in the IceMaker.

6 Maintenance

6.1 Defrosting with NoFrost*

The NoFrost system automatically defrosts the appliance.

Refrigerator compartment:

The defrost water evaporates due to the compressor heat.

- ▶ Regularly clean the drain opening to allow the water to flow away (see 6.3).

Freezer compartment:

The moisture condenses on the evaporator, is periodically defrosted and evaporates.

- ▶ The appliance does not have to be manually defrosted.

6.2 Manual defrosting*

The **refrigerator compartment** is defrosted automatically. The defrost water evaporates as a result of the heat of the compressor. Drops of water on the rear wall are perfectly normal.

- ▶ Regularly clean the drain opening to allow the water to flow away (see 6.3).

A layer of frost or ice can build up in the **freezer compartment** after a long period of operation.

The layer of frost or ice builds up faster if the appliance is opened often or if the food is warm when placed inside. However, a thick layer of ice will increase the appliance's energy consumption. You should therefore defrost the appliance regularly.



CAUTION

Risk of injury and damage as a result of hot steam!

- ▶ Do not use electric heaters or steam cleaners, naked flames or defrosting sprays for defrosting.
- ▶ Do not remove ice using sharp instruments.

- ▶ Switch on SuperFrost one day before defrosting.
- ▷ The frozen goods are provided with a "cold reserve".
- ▶ Switch off the appliance.
- ▷ The temperature display goes out.
- ▷ If the temperature display does not go out, the child lock function (see 5.1) is active.

Maintenance

- ▶ Pull out the power plug or switch off the fuse.
- ▶ Place cold storage accumulators on top of the frozen food.
- ▶ If possible, put the frozen goods in the freezer drawer, wrapped in newspaper or a blanket, and store in a cool place.
- ▶ Place a pan with hot, not boiling water on a middle shelf.

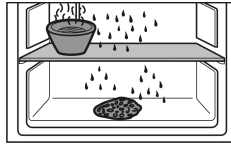

-or-

- ▶ Half-fill the two lower drawers with lukewarm water and put them in the appliance.
- ▷ Defrosting is speeded up.
- ▷ Defrost water is collected in the drawers.
- ▶ Leave the door of the appliance open while defrosting.
- ▶ Remove detached pieces of ice.
- ▶ Pay attention that the defrost water does not run into the kitchen unit.
- ▶ If necessary, pick up defrost water several times, using a sponge or cloth.
- ▶ Clean the appliance (see 6.3) and rub dry.

6.3 Cleaning the appliance



WARNING

Risk of injury and damage as a result of hot steam!
Hot steam can lead to burns and can damage the surfaces.

- ▶ Do not use any steam cleaners!

NOTICE

Incorrect cleaning damages the appliance!

- ▶ Do not use cleaning agents in concentrated form.
- ▶ Do not use any scouring or abrasive sponges or steel wool.
- ▶ Please do not use any aggressive, scouring, sand-, chloride-, chemical- or acid-based cleaning agents.
- ▶ Do not use chemical solvents.
- ▶ Do not damage or remove the type plate on the inside of the appliance. It is important for the customer service.
- ▶ Do not pull off, bend or damage cables or other components.
- ▶ Do not allow any cleaning water to enter the drain channel, ventilation grille or electrical parts.
- ▶ Please use soft cleaning cloths and a universal pH-neutral cleaning agent.
- ▶ Please use cleaning and care products suitable for contact with foodstuffs in the appliance interior.

- ▶ **Empty appliance.**
- ▶ **Pull out the power plug.**



- ▶ Clean **plastic outer and inner surfaces** with lukewarm water and a little washing-up liquid.
- ▶ Clean **drain hole**: Remove deposits with a narrow instrument, e.g. a cotton bud.

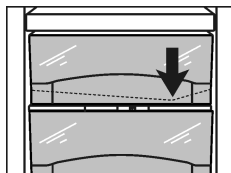

- ▶ Most of the **parts** can be dismantled for cleaning: see the relevant chapter.
- ▶ The **door interior parts** are dishwasher-safe. However, the printing may dissolve over time.
- ▶ Clean **other items of equipment** by hand with lukewarm water and a little washing-up liquid.
- ▶ Only use a damp cloth to clean the **telescopic rails**. The grease in the runners is for lubrication purposes and must not be removed.

After cleaning:

- ▶ Wipe dry the appliance and items of equipment.

- ▶ Connect the appliance and switch it on again.
- ▶ Switch on SuperFrost (see 5.6.4).
When the temperature is sufficiently cold:
- ▶ Put the food back inside.

6.4 Cleaning the IceMaker*

The drawer of the IceMaker has to be emptied and slid in.

- ▶ To activate the setting mode: press the SuperFrost button *Fig. 2 (12)* for about 5 s.
- ▷ The display indicates **ε**.
- ▷ The menu symbol *Fig. 2 (16)* shines.
- ▶ Using the Up setting button, freezer compartment *Fig. 2 (10)* / Down setting button, freezer compartment *Fig. 2 (11)* select **l**.
- ▶ To confirm: press the SuperFrost button *Fig. 2 (12)*.
- ▶ Using the Up setting button, freezer compartment *Fig. 2 (10)* / Down setting button, freezer compartment *Fig. 2 (11)* select **lc**.
- ▶ To confirm: press the SuperFrost button *Fig. 2 (12)*.
- ▶ To deactivate the setting mode: press the On/Off button, freezer compartment *Fig. 2 (8)*.



-or-

- ▶ Wait for 2 minutes.
- ▷ The temperature is indicated again in the temperature display.
- ▶ Remove the drawer.
- ▶ Clean the ice cube tray and drawer with warm water. If necessary, use mild washing-up liquid. Then rinse.
- ▶ Slide in the drawer again.
If washing-up liquid was used:
- ▶ throw away the first three loads of ice cubes to get rid of any remaining washing-up liquid.

Either leave the IceMaker switched off in this position or switch the IceMaker on again (see 5.6.10).

6.5 Customer service

First check whether you can correct the fault yourself by reference to the list (see Malfunction). If this is not the case, please contact the customer service whose address is given in the enclosed customer service list.



WARNING

Risk of injury if repair work is not carried out professionally!

- ▶ Have any repairs and action - not expressly specified - on the appliance and mains cable carried out by service personnel only. (see Maintenance)

- ▶ Read the appliance designation *Fig. 14 (1)*, service No. *Fig. 14 (2)* and serial No. *Fig. 14 (3)* off the type plate located inside the appliance on the left-hand side.

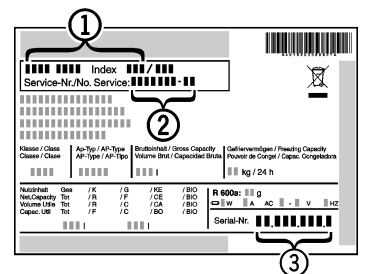

Fig. 14

- ▶ Notify the customer service, specifying the fault, appliance designation *Fig. 14 (1)*, service No. *Fig. 14 (2)* and serial No. *Fig. 14 (3)*.
- ▷ This will help us to provide you with a faster and more accurate service.
- ▶ Keep the appliance closed until the customer service arrives.

- ▷ The food will stay cool longer.
- ▶ Pull out the mains plug (not by pulling the connecting cable) or switch off the fuse.

7 Malfunzion

Your appliance is designed and manufactured for a long life span and reliable operation. If a malfunction nonetheless occurs during operation, check whether it is due to a handling error. In this case you will have to be charged for the costs incurred, even during the warranty period. You may be able to rectify the following faults yourself:

Appliance does not work.

- The appliance is not switched on.
- ▶ Switch on the appliance.
- The power plug is not properly inserted in the wall socket.
- ▶ Check power plug.
- The fuse of the wall socket is not in order.
- ▶ Check fuse.

The compressor runs for a long time.

- The compressor switches to a low speed when little cold is needed. Although the running time is increased as a result, energy is saved.
- ▶ This is normal in energy-saving models.
- SuperFrost is activated.
- ▶ The compressor runs for longer in order to rapidly cool the food. This is normal.
- SuperCool is activated.
- ▶ The compressor runs for longer in order to rapidly cool the food. This is normal.

A LED on the bottom rear of the appliance (at the compressor) flashes repeatedly every 5 seconds*.

- There is a fault.
- ▶ Please contact the after-sales service (see Maintenance).

Excessive noise.

- Due to the various speed steps, speed-regulated* compressors can generate different running noises.
- ▶ The sound is normal.

A bubbling and gurgling noise.

- This noise comes from the refrigerant flowing in the refrigeration circuit.
- ▶ The sound is normal.

A quiet clicking noise.

- The noise is produced whenever the refrigeration unit (motor) automatically switches on or off.
- ▶ The sound is normal.

A hum. It is briefly a little louder when the refrigeration unit (the motor) switches on.

- The refrigeration increases automatically when the SuperFrost, function is activated, fresh food has just been placed in the appliance or the door has been left open for a while.
- ▶ The sound is normal.
- The refrigeration increases automatically when the SuperCool function is activated, fresh food has just been placed in the appliance or the door has been left open for a while.
- ▶ The sound is normal.
- The ambient temperature is too high.
- ▶ Solution: (see 1.2)

A low hum.

- The sound is produced by air flow noise of the fan.
- ▶ The sound is normal.

Vibratory noise.

- The appliance is not fixed to the ground. The running of the cooling unit therefore makes objects and adjacent furniture vibrate.
- ▶ Check installation and reposition appliance as required.

- ▶ Move bottles and containers apart.

Flow sound at the soft stop mechanism.

- The noise is produced when the door is opened and closed.
- ▶ The sound is normal.

The temperature display indicates: F0 to F9

- There is a fault.
- ▶ Please contact the after-sales service (see Maintenance).

The temperature display reads: FE*

- There is a fault.
- ▶ Please contact the after-sales service (see Maintenance).

The temperature display indicates power failure . The warmest temperature reached during the power failure appears in the temperature display.

- The freezer temperature rose too high over the last hours or days due to a power failure or power interruption. When the power interruption is over, the appliance will continue to operate in the last temperature setting.
- ▶ To cancel the display of the warmest temperature: press alarm button *Fig. 2 (14)*.
- ▶ Check the quality of the food. Do not consume spoiled food. Do not re-freeze thawed food.

DEMO shines in the temperature display.

- The demo mode is activated.
- ▶ Please contact the after-sales service (see Maintenance).

The outer surfaces of the appliance are warm*.

- The heat of the refrigeration circuit is used to prevent condensate from forming.
- ▶ This is normal.

The IceMaker cannot be switched on. *

- The appliance and therefore the IceMaker are not connected.
- ▶ Connect the appliance to the mains (see Putting into operation).

The IceMaker does not make any ice cubes.*

- The IceMaker is not switched on.
- ▶ Switch on the IceMaker.
- The drawer of the IceMaker is not properly closed.
- ▶ Close the drawer properly.
- The water connection is not open.
- ▶ Open the water connection.
- The water intake to the IceMaker has been interrupted.
- ▶ Check the water connection (see **Water Connection in the Fitting Instructions**).*
- ▶ Check the hosing (see **Water Connection in the Fitting Instructions**).*
- The screen located in the end piece of the water intake hose or the screen located in the connecting piece on the appliance is blocked.
- ▶ Clean the screens.

The temperature is not cold enough.

- The door of the appliance is not properly closed.
- ▶ Close the door of the appliance.
- Insufficient ventilation.
- ▶ Clear ventilation grilles.
- The ambient temperature is too high.
- ▶ Solution: (see 1.2) .
- The appliance was opened too frequently or for too long.
- ▶ Wait to see whether the appliance reaches the required temperature by itself. If not, please contact the after sales service (see Maintenance).
- Too much fresh food was placed inside without SuperFrost.
- ▶ Solution: (see 5.6.4)
- The temperature is incorrectly set.

Decommissioning

- ▶ Set the temperature to a colder setting and check after 24 hours.
- The appliance is too close to a source of heat (stove, heater etc).
- ▶ Change the position of the appliance or the source of heat.
- The appliance was not inserted properly into the recess.
- ▶ Check whether the appliance was inserted correctly and the door closes properly.

The interior light is not on.

- The appliance is not switched on.
- ▶ Switch on the appliance.
- The door was open longer than 15 min.
- ▶ The interior light automatically switches off if the door has been open for about 15 min.
- The LED illumination is defective or the cover is damaged:



WARNING

Risk of injury due to electric shock!
Live parts are located under the cover.

- ▶ Have the LED interior light changed or repaired only by the customer service or by specialized personnel trained for the purpose.



WARNING

Danger of injury by LED lamp!
The light intensity of the LED illumination corresponds to laser class 1/1M.

If the cover is defective:

- ▶ Do not look into the illumination with optical lenses from the immediate proximity. This can cause injury to the eyes.

The door gasket is defective or should be replaced for other reasons.*

- The door gasket can be replaced on some appliances.
- ▶ Please contact the after-sales service (see Maintenance).

8 Decommissioning

8.1 Switching off the appliance

Note

- ▶ To switch off the entire appliance it is necessary only to switch off the freezer compartment.

8.1.1 Switching off the freezer compartment

- ▶ Press the freezer compartment On/Off button *Fig. 2 (8)* for approx. 2 seconds.
- ▷ A long beep is emitted. The temperature displays are dark. The appliance is switched off.
- ▷ If the appliance cannot be switched off, the child lock function is active (see 5.1).



8.1.2 Switching off the refrigerator compartment with BioFresh compartment

Note

- ▶ The refrigerator compartment can be switched off separately, if required.
- ▶ Press the refrigerator compartment On/Off button *Fig. 2 (1)* for approx. 2 seconds.
- ▷ The temperature display of the refrigerator compartment *Fig. 2 (2)* is dark. The refrigerator compartment and BioFresh compartment are switched off.

8.2 Taking the appliance out of service*

- ▶ Empty the appliance.
- ▶ Put the IceMaker in the cleaning position (see Maintenance).
- ▶ Pull out the power plug.
- ▶ Clean the appliance (see 6.3).

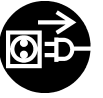

- ▶ Leave the door open to prevent odour.

9 Disposing of the appliance

The appliance contains some reusable materials and should be disposed of properly - not simply with unsorted household refuse. Appliances which are no longer needed must be disposed of in a professional and appropriate way, in accordance with the current local regulations and laws.



When disposing of the appliance, ensure that the refrigeration circuit is not damaged to prevent uncontrolled escape of the refrigerant it contains (data on type plate) and oil.

- ▶ Disable the appliance.
- ▶ Pull out the plug.
- ▶ Cut through the connecting cable.

Liebherr Hausgeräte Ochsenhausen GmbH * Memminger Strasse 77-79 * 88416 Ochsenhausen * Deutschland * www.liebherr.com

Free Manuals Download Website

<http://myh66.com>

<http://usermanuals.us>

<http://www.somanuals.com>

<http://www.4manuals.cc>

<http://www.manual-lib.com>

<http://www.404manual.com>

<http://www.luxmanual.com>

<http://aubethermostatmanual.com>

Golf course search by state

<http://golfingnear.com>

Email search by domain

<http://emailbydomain.com>

Auto manuals search

<http://auto.somanuals.com>

TV manuals search

<http://tv.somanuals.com>