

LIEBHERR

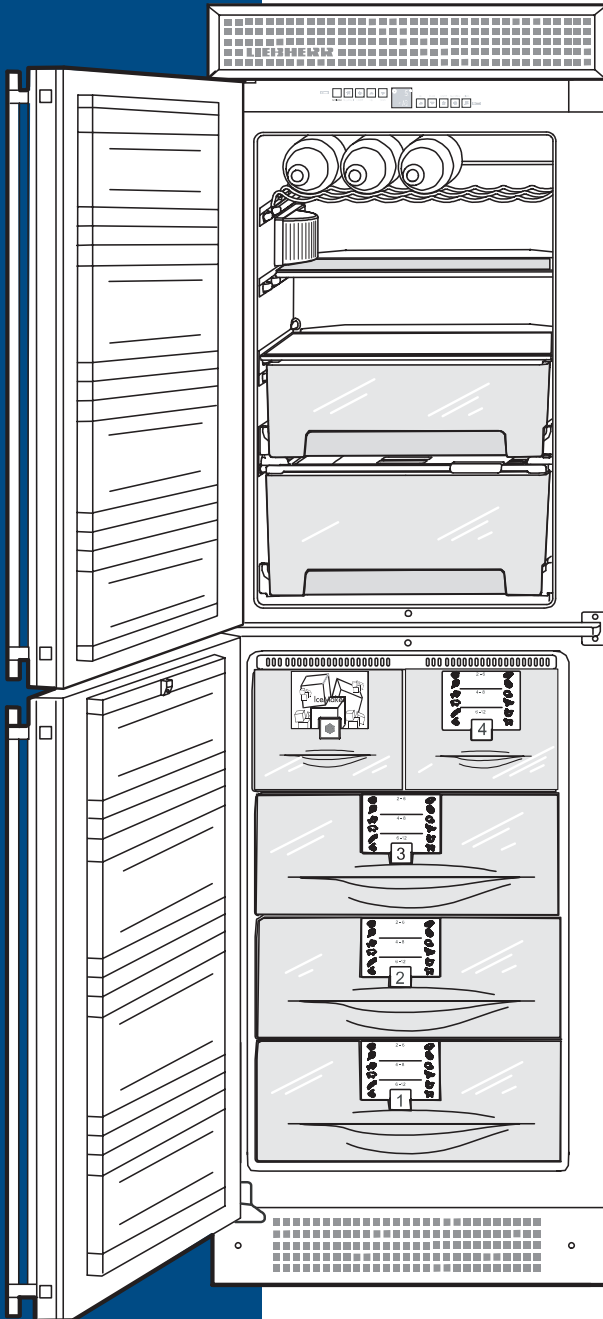

Use and Care Manual

For BioFresh, NoFrost, Combined
Refrigerator-Freezers and
Side-By-Side Units

Manuel d'utilisation et d'entretien

Pour combinés
réfrigérateur-congérateurs
anti-givre BioFresh et les
appareils côte à côte

Instrucciones de manejo y de mantenimiento

frigorífico-congelador BioFresh,
NoFrost y unidades lado a lado

BF/BFI 1051
BGEN/es 2956
7082 244-01 0306

Congratulations on your purchase. Choosing this appliance means you want all the benefits of state-of-the-art refrigeration technology, guaranteeing you top quality, a long appliance life span and excellent reliability.

The features on your appliance have been designed to ensure maximum convenience - day in, day out.

This appliance has been manufactured with recyclable materials using an environmentally friendly process, so together we're making an active contribution to the preservation of our environment.

To get to know all the benefits of your new appliance, please read the information contained in these operating instructions carefully.

We know you will be pleased with your new appliance.

Additional benefits

- CFC-free
- Energy-optimized refrigerant circuit
- Energy-efficient insulation
- Low energy consumption

- User-friendly electronic controls
- Display of functions switched on
- Temperature can be controlled within climate rating range, regardless of room temperature. Temperature can also be displayed in degrees Fahrenheit or degrees Celsius. Choose the unit of temperature °F or °C.
- Refrigerator and freezer compartments defrost automatically - no need to spend time defrosting

- Big net refrigerator capacity
- Variable and practical features
- Safety-glass storage shelves
- Big net freezer capacity
- Shelves can be removed to make space for large items

- Freezer temperature increase alarm
- Audible door open alarm
- Power failure/"frost-control" display
- Fresh food can be fast-frozen as required
- All drawers suitable for fast freezing
- Transport grips on all extra-large drawers

- Integrated transport grips on appliance housing
- Transport castors at back

- Easy to clean
- Door hinges can be changed over

TABLE OF CONTENTS

Contents	Page
Safety	2
Disposal of Old Appliance.....	2
Important Safety Information.....	2
Electrical Safety.....	3
IceMaker (if equipped).....	3
Safety Instructions and Warnings	3
Unpacking	4
Disposal of Carton.....	4
Safety Regulations	4
Operation	5
Turning the Appliance ON and OFF	5
Setting the Temperature	5
Additional Features.....	6
Temperature Display.....	6
Audible Warning Signal	6
Audible Door Alarm	7
Audible/Visual Temperature Alarm	7
Power Failure/Frost-Control Display.....	7
SuperFrost	7
BioCool	7
BioFresh Compartment.....	8
Humidity Selection.....	8
Storage Times	8
Arranging Food.....	10
Shelf Arrangement	10
Drawer	11
Interior Light.....	11
Freezer Compartment.....	12
Freezing, Storage	12
Freezing with SuperFrost	12
Information System	12
Freezer Tray.....	12
Freezing and Storage.....	13
Storage	13
Removing Drawers.....	13
Removing and Installing the Shelves.....	13
IceMaker.....	14
To Start the IceMaker.....	14
To Clean the IceMaker	14
Defrosting/Cleaning	15
Defrosting	15
Cleaning.....	15
Vacation Tips	16
Troubleshooting.....	17
Warranty.....	18
Customer Service.....	18
Appliance Information.....	18
Liebherr Warranty Plan.....	19

IMPORTANT

All types and models are subject to continuous improvement. The manufacturer reserves the right to make modifications in the shape, equipment and technology.

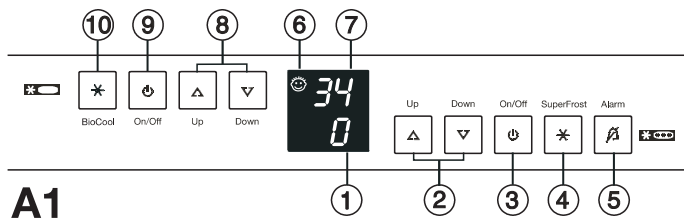

A1

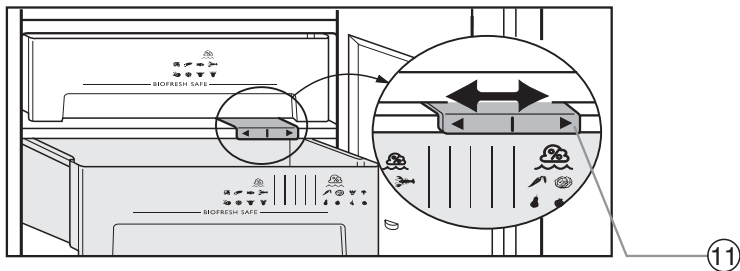

A2

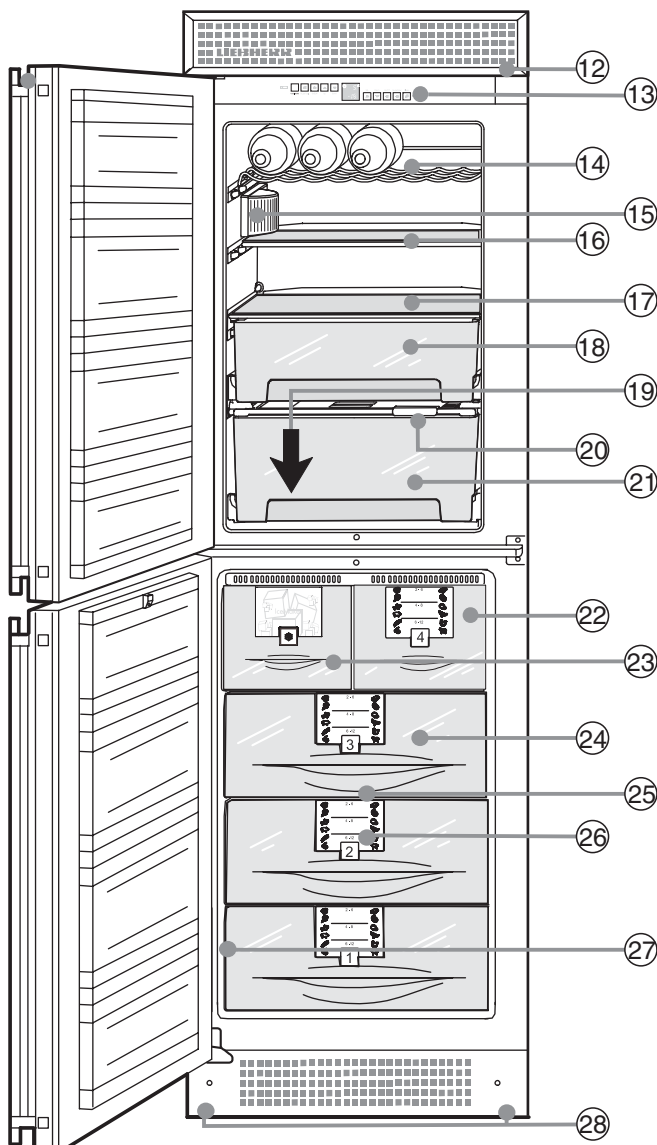

A

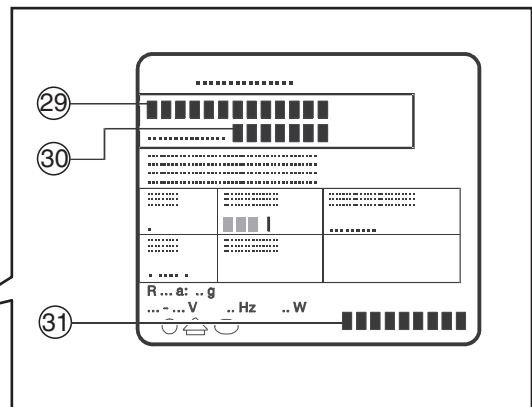

Figure 1

Operating and Control Elements - Figure 1 Freezer

- (1) Temperature Display and Setting Display, with "nA" display for power failure and FrostControl with query of highest temperature
- (2) Temperature Buttons:
 - ▲ "UP" = warmer temperatures,
 - ▼ "DOWN" = cooler temperatures
- (3) Freezer ON/OFF Button
- (4) SuperFrost Button, Lit = Function Activated
- (5) Alarm ON/OFF Button
- (6) Childproof Lock Display (refrigerator and freezer), Lit = active, BioFresh and freezer compartment are protected against being switched ON accidentally

BioFresh Compartment

- (7) Temperature Display and Setting Display
- (8) Temperature Buttons:
 - ▲ "UP" = warmer temperatures,
 - ▼ "DOWN" = colder temperatures
- (9) ON/OFF Button
- (10) BioCool Button, Lit = Function Activated
For fast cooling of food in the BioFresh compartment.
- (11) Humidity Setting in BioFresh Drawer, slider to left: dry, slider to right: humid storage climate

Description of Unit

- (12) Rear Transport Grips
- (13) Operating and Control Elements

Description of BioFresh Compartment, 32°F to 36°F (0°C to 2°C)

- (14) Beverage Rack, rack for standard-size champagne bottles and champagne miniatures
- (15) Interior Light
- (16) Sectioned Shelf
- (17) Zone, with relatively dry storage climate
- (18) Drawer, for dry and packaged food
- (19) Defrost Drain
- (20) Humidity Setting in BioFresh Drawer, slider to left: dry, slider to right: humid storage climate
- (21) Humidity Control, for storing salad, vegetables and fruit in a humid climate.

Freezer Compartment, approximately 0°F (-18°C)

- (22) Drawers, with transparent front panels
- (23) IceMaker*
- (24) Freezer Tray*, Cold-Storage Accumulator*
- (25) Removable Shelves and Drawers, for large items - VarioSpace
- (26) Information System*
- (27) Type/Model Plate
- (28) Adjustable roller base, transport grips, transport castors at back

Model Plate

- (29) Type designation
- (30) Service number
- (31) Appliance number

* Depending on model and options

SAFETY

Read and follow all the safety rules and operating instructions before using this appliance. Save these instructions for future reference. Throughout this instruction manual are specific Important instructions, Cautions and Warnings.

IMPORTANT

This highlights information that is especially relevant to a problem-free installation.



CAUTION

Signals a situation where minor injury or product damage may occur if you do not follow instructions.



WARNING

States a hazard which may cause serious injury or death if precautions are not followed.



DANGER

States a hazard will cause serious injury or death if precautions are not followed.

Disposal of Old Appliance

Be sure to follow your local requirements for disposal of appliances. Discarded appliances can be dangerous.



DANGER

Risk of child entrapment. Before you discard your old refrigerator or freezer:

- **Be sure to follow your local requirements for disposal of appliances. Discarded appliances can be dangerous.**
- **Remove the doors.**
- **Leave the shelves in place so that children may not easily climb inside.**
- **Cut off the prongs from the power cable plug and discard them.**
- **Cut off the power cable from the discarded refrigerator. Discard separately from the refrigerator.**

Following these instructions reduces the possibility of causing personal injury, especially to children playing.

Contact the trash collection agency in your area for additional information.

Important Safety Information

This appliance is intended for domestic use only. Use the appliance only for its intended purpose, the storage of food products. Follow the cautions and safety warnings throughout this instruction manual including the following:

- To prevent injury to you or damage to the unit, the appliance should be unpacked and set up by two people.
- If the appliance is damaged on delivery, contact the supplier immediately before connecting to the power source.
- To guarantee safe operation, ensure that appliance is set up and connected as described in these operating instructions.
- Disconnect the appliance from the power source if a fault occurs. Pull out the plug, turn off or remove the fuse.
- When disconnecting the appliance, use the plug. Do not pull on the cable.
- Any repairs and work on the appliance should only be carried out by the customer service department. Unauthorized work may be dangerous to the user. Changing the power source cable should only be done by the customer service department.
- Do not eat ice cream, particularly ice cream treats, or ice cubes, immediately from the freezer compartment. There is a risk of “burning” because of the very cold temperatures.
- Do not consume food which has been stored for too long; it could cause food poisoning.
- The appliance is designed for cooling, freezing and storage of food, and for making ice. It is intended for domestic use. If used for commercial purposes, the relevant legal regulations applicable to the trade concerned must be observed.
- Do not store explosives or sprays using combustible propellants such as butane, propane, pentane, etc. in the appliance. Electrical components might cause leaking gas to ignite. You may identify such sprays by the printed contents or a flame symbol.

- Do not use electrical appliances inside the appliance.
- Do not allow children to play with the appliance. Children must not climb, sit or stand on the shelves, drawers or door.
- To prevent possible injury due to an electrical shock, be sure to disconnect the power cord or turn off the circuit breaker before replacing the interior light or cleaning the appliance.
- To prevent possible injury due to broken glass, use hand protection when replacing the interior light.
- To avoid injury or damage to the appliance, do not use steam cleaning equipment to clean the appliance.
- Do not operate the refrigerator in the presence of explosive fumes.
- In the event of a power outage, minimize opening the refrigerator door(s). Protect the food either by placing dry ice on top of the packages or using a local frozen food locker if the power failure is of a long duration. Do not attempt to re-freeze any thawed previously frozen food.
- To avoid possible injury, only adjust an empty shelf. Do not attempt to adjust a shelf with food on it.
- To protect the refrigerator from possible damage, allow the appliance to stand 1/2 to 1 hour in place before turning the electricity on. This allows the refrigerant and system lubrication to reach equilibrium.

Electrical Safety

Connect this appliance to a 110-120 VAC, 15 amp (20 Amp for side-by-side installations) circuit that is controlled by a circuit breaker or fuse. This appliance should have its own separate grounded circuit. Do not use an extension cord.

The power cord is equipped with a three-prong (grounding) plug for your protection against possible shock hazards. To maintain this protection:

- Do not modify the plug by removing the round grounding prong.

- Do not use a two-prong adapter. Where a two-prong wall receptacle is encountered, contact a qualified electrician and have it replaced with a three-prong receptacle in accordance with all local codes and ordinances.
- Do not use a power cord that is frayed or damaged.

IceMaker (if equipped)

The icemaker for a combined refrigerator-freezer is located in the freezer compartment. It must be connected to the water supply to function properly. These instructions only refer to the installation and operation of the icemaker. Please refer to the Use and Care Manual provided with the appliance for other installation and operation instructions. The combined refrigerator-freezer must be level for the icemaker to function properly.

Safety Instructions and Warnings

- Do not make the water connection while the combined refrigerator-freezer is connected to an electrical outlet.
- The connection to the water supply may only be made by a trained and licensed plumber.
- The water quality must comply with the drinking water regulations for the geographical area where the appliance is located.
- The icemaker is designed exclusively to make ice cubes in quantities needed by a household and may only be operated with water appropriate for this purpose.
- All repairs and work on the icemaker may only be done by customer service personnel or other trained personnel.
- **Do not consume or use the first three batches of ice. This applies both to using the appliance for the first time and also using it after it has not been used for a long period of time.**
- **The manufacturer cannot accept liability for damage caused by equipment or water lines between the solenoid valve and the water supply.**

UNPACKING

⚠ CAUTION

To avoid risk of personal injury or property damage, have two people unpack and move this appliance into place.

⚠ CAUTION

Protect the finished floor surface before you uncrate the unit.

Avoid placing the appliance in direct sunlight or near the stove, range top, radiators and similar heat sources. DO NOT place microwave ovens, toaster ovens or other heat-emitting appliances on top of this unit.

The floor under the appliance should be flat and level.

Keep the appliance out of the weather. The ventilation grilles should not be obstructed. Always ensure there is good ventilation all around the appliance.

As soon as you uncrate the unit:

- Examine the unit and packaging for shipping damage. Contact the carrier immediately if you suspect there is any damage.
- Note the type (model number), index, serial number, date of purchase and where purchased on the spaces provided in the back of this manual.

Disposal of Carton

The packaging is designed to protect the appliance and individual components during moving and is made of recyclable materials.

- Corrugated board/board
- Molded polystyrene (foamed, CFC-free polystyrene)
- Polythene bags and sheets
- Polypropylene straps

⚠ WARNING

Keep packaging materials away from children. Polythene sheets and bags can cause suffocation!

- Please take the packaging material to your local recycling facility.

Safety Regulations

The appliance complies with UL250 and is designed to cool, freeze and store food and to make ice (if equipped). It is designed as a household appliance. If used commercially, the relevant regulations on commercial use must be observed.

The appliance is set to operate within specific ambient temperature limits according to its climate rating. These temperature limits should not be exceeded. The correct climate rating for your appliance is indicated on the model plate.

This is explained as follows:

Climate Rating	Set for Ambient Temperatures of
SN	50°F to 90°F (10°C to 32°C)
N	61°F to 90°F (16°C to 32°C)
ST	65°F to 100°F (18°C to 38°C)
T	65°F to 109°F (18°C to 43°C)
SN-T	50°F to 109°F (10°C to 43°C)

- The refrigerant circuit has been tested for leaks.
- The appliance complies with current safety regulations UL250 and CSA C22.2 #63.

We recommend cleaning the appliance before turning it ON for the first time. See **Cleaning**. Turn ON the appliance several hours before loading it with frozen food for the first time. Do not load with frozen food until the temperature shows approximately 0°F (-18°C).

⚠ WARNING

Do not allow children to play with the appliance. Children must not climb, sit or stand on the shelves, drawers or door.

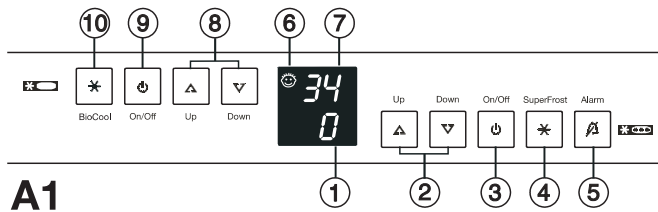

A1

(From Figure 1)

Turning the Appliance ON and OFF - Figure 1

Clean the appliance before turning it on for the first time. See **Cleaning**.

Allow the appliance to operate approximately two hours before placing food in it. DO NOT place frozen food in the freezer until the temperature shows at least 0°F (-18°C). The refrigerator and freezer compartments can be operated separately.

Pressing the appliance main ON/OFF switch (**Fig. 1, 3**) always turns the entire appliance, both the BioFresh and the freezer compartment, ON or OFF.

1. Turning ON:

Press the BioFresh ON/OFF button (**Fig. 1, 9**) and the Freezer ON/OFF button (**Fig. 1, 3**), the Temperature Displays (**Fig. 1, 1**) and (**Fig. 1, 7**) light up or "flash".

- The interior light will turn ON when the refrigerator door is open.
- The freezer compartment display will display lines until a temperature less than 32°F (0°C) is reached.

2. Turning OFF: Press the Refrigerator ON/OFF button and the Freezer ON/OFF button for about one second so the temperature displays go out.

If you only want to turn OFF the BioFresh compartment, and leave the freezer compartment ON, press ON/OFF button (**Fig. 1, 9**). This is very useful during vacation periods or when using the freezer only. The BioFresh temperature display (**Fig. 1, 7**) and the interior light will go out. The freezer temperature (**Fig. 1, 1**) will display.

Setting the Temperature - Figure 1

The appliance is pre-set for normal operation. We recommend temperatures of 34°F (+1 °C) in the BioFresh compartment and 0°F (-18 °C) for the freezer.

To reduce the temperature:

Press the ▼ (DOWN) button; (**8**) on left for BioFresh compartment and (**2**) on right for the freezer compartment.

To increase the temperature:

Press the ▲ (UP) to increase temperature (**Fig. A1, 2 or 8**).

The temperature in the BioFresh compartment is controlled automatically, between 32°F to 36°F (0°C and 2°C). If you want a higher or lower temperature, for example, for storing fish, you can alter the temperature setting in the BioFresh compartment. The setting range is displayed as between **b1** and **b9**. The default factory setting is **b5**.

The temperature can be changed by ± 5 increments, displayed in the temperature display.

Note

*By decreasing the temperature, **b4** to **b1**, minus temperatures can be reached and the food will freeze slightly.*

For the **freezer compartment**, the setting range is displayed between 8°F and -14°F (-13°C and -26°C). Whether you can obtain the lowest freezer temperature depends on where the appliance is positioned (if it is located in an area with a high ambient temperature it will not reach the lowest temperature).

While you are entering the temperature, the set temperature will flash on the display.

When you press the temperature setting buttons for the first time, the most recent setting is displayed.

You can change the settings in increments by briefly pressing the buttons again. If the buttons are held down, the temperature setting will change faster. Approximately five seconds after the button has been released, the display will automatically show the actual freezing or BioFresh temperature (known as the "actual setting").

The altered temperature will adjust slowly to the new value.

OPERATION

Additional Features

In set-up mode you can set the **Childproof Lock**, adjust the **brightness of the display*** and choose the **unit of temperature** in degrees Fahrenheit or degrees Celsius for the display.



To activate the set-up mode:

- Press SuperFrost button for approximately five seconds, the SuperFrost button will flash and the display shows  for Childproof Lock.







Note





The value to be altered will flash.





- Select the required function by pressing the  (UP/DOWN) button:

-  = childproof lock or
-  = brightness or
-  = unit of temperature.

- Now select/acknowledge function by pressing the SuperFrost button briefly:

- For  = **childproof lock**, press the  (UP/DOWN) button to select  = childproof lock ON or  = childproof lock OFF and acknowledge with the SuperFrost button. When the symbol  (6) is lit, the childproof lock is activated. 

- For  = **brightness**, press the  (UP/DOWN) button to select  = minimum to  = maximum brightness and acknowledge with the SuperFrost button. 

- For  = **unit of temperature**, press the  (UP/DOWN) button to select  = degrees Celsius or  = degrees Fahrenheit for temperature display and acknowledge with the SuperFrost button. 



To exit set-up mode:

- Press the ON/OFF button; after two minutes the electronic system automatically switches over and the normal operating mode is activated.

Temperature Display - Figure 1

When the appliance is turned ON (**Fig. 1, 3**), the set unit of temperature °F or °C appears on the display (**Fig. 1, 7**) for a few seconds. If you wish to change the unit of temperature, you can change the display. Refer to **Additional Features, Unit of Temperature** for more information.

In normal operation, the following settings will be displayed:

-  – the average BioFresh temperature in display (**Fig. 1, 7**)
-  – the warmest frozen food temperature in display (**Fig. 1, 1**).

The display will flash:

- if you change the temperature or
- if the temperature rises by several degrees, indicating a rise in temperature from placing fresh, “warm” food in the freezer or if you remove or re-pack frozen food, the temperature may rise for a short time due to warm air flowing into the freezer.

Once you have finished loading or re-packing, the electronics will automatically re-set the temperature to the most recent setting. Short-term rises in temperature will not affect the frozen food.

- If *F1* to *F5* appears in the display, the appliance has recognized a fault. Contact your Liebherr retailer or the customer service department and indicate the fault number displayed, this will tell the technician what kind of irregularity has occurred.

Audible Warning Signal - Figure 1

The audible warning signal helps to protect frozen food and to save energy.

The audible warning device is turned off by pressing the audible warning ON/OFF button (**Fig. 1, 5**).

The alarm will turn off automatically as soon as the temperature is low enough or the door is closed.

Audible Door Alarm - For BioFresh and Freezer Compartment

The audible door alarm will sound when the doors have been left open for longer than 60 seconds.

The alarm will sound as long as the door is left open or the ON/OFF button is not pressed.

The alarm will automatically reset when the door is closed.

Audible/Visual Temperature Alarm - For Freezer Compartment

The alarm always sounds if the freezer temperature is not low enough based on the temperature setting. The temperature display will also flash at the same time.

This can be caused by:

- warm, fresh food being placed in the freezer.
- too much warm air from the outside is entering when re-arranging or removing frozen food.

The temperature display will continue to flash until the cause has been rectified. It will then stop flashing and temperature will display. The audible warning signal will also reset.

Power Failure/Frost-Control Display - Figure 1

 If *nA* appears in the display, this means the freezer temperature has risen too **high** during the last few hours or days due to a power failure.

- If you press the Alarm button (**Fig. 1, 5**) while the display is reading, the highest temperature registered during the power failure will be displayed.
- Check the quality of the food in case it has become too warm or even defrosted.
- The highest temperature will appear for approximately one minute. After that, the actual temperature in the freezer will reappear. The display can be turned OFF by repeatedly pressing the Alarm button.

Once the power is re-instated, the appliance will continue to operate at the most recent temperature setting

SuperFrost - Figure 1

Fresh food should be frozen to the core as rapidly as possible. Frozen food can also be given a cold boost. This is provided by the SuperFrost feature (Fig. 1, 4) and ensures the nutritional value, appearance and flavor of the food remains intact.

- For more information, refer to **Freezing with SuperFrost**.

BioCool - Figure 1

The BioCool button switches the BioFresh compartment to maximum cooling. It is recommended to cool large quantities of food, freshly baked cakes or meals rapidly.

- **To turn ON:** Press the BioCool button (Fig. 1, 10) briefly. When the symbol is lit, BioCool is activated.

Note

The BioCool function uses slightly more energy. After approximately six hours, the electronic control system will automatically switch back to normal energy-saving operation.

The BioCool function can be turned OFF sooner.

- **To turn OFF:** Press the BioCool button, if the indicator is lit and BioFresh will turn OFF.

BioFRESH COMPARTMENT

The BioFresh Compartment

The BioFresh compartment enables you to keep a range of fresh food fresh for up to three times as long as you would in a standard refrigerator, thus making your food last longer. Taste, freshness and nutritional value (vitamin B and C group content) remain largely intact. Spoilage and weight loss in vegetables and fruit are reduced, leaving food more fresh and natural.

The automatically controlled storage temperature, which is kept between 32°F and 36°F (0°C and 2°C), and the resulting humidity provide the ideal storage conditions for different types of food.

The top drawer:

- is suitable for storing dry and wrapped food (e.g. dairy products, meat, fish, cold meats). The storage climate in this drawer is relatively dry.

The drawer with humidity control:

- can be set to “humid” for storage of unwrapped salad, vegetables and fruit. When the drawer is full, the climate will be “dew-fresh,” with approximately 90% humidity.

You can set the humidity in this drawer to dry or moist as desired.

Humidity Selection - Figure 2

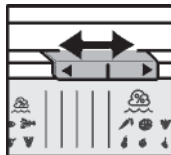

Figure 2

“dry” setting: small humidity symbol – slide control to left. This setting is suitable for food to be stored in a dry climate.

“humid” setting: high relative humidity of a maximum of 90%, large humidity symbol – slide control to right. This setting is suitable for storing unwrapped food with a high moisture content such as fresh lettuce.

Tips:

- The humidity in the compartment depends on the moisture content of the food in it, and the frequency with which the compartment is opened.
- When buying food, make sure it is fresh; the fresher the product and the higher the quality, the longer it will keep.
- Unwrapped meat and vegetables should be stored separately in the drawers. If there is not enough space for them to be stored separately, make sure they are wrapped.
- Do not allow different types of meat to come into contact with one another but keep them packaged separately to avoid premature bacterial spoilage.
- Note that protein-rich food spoils more quickly, i.e. crustaceans and shellfish spoil faster than fish, and fish faster than meat.
- Remove food from the drawers some time before consumption. Enjoyment will be enhanced in this way as the aroma and flavor develop best at room temperature.

Storage Times

- for food in the BioFresh Compartment:

Dry setting

Butter.....	up to 30 days
Cheese, soft.....	up to 30 days
Milk, fresh.....	up to 7 days
Sausage, cold cuts.....	up to 7 days
Fish.....	up to 4 days
Shellfish.....	up to 3 days
Poultry.....	up to 5 days
Pork large portions.....	up to 7 days
cut up.....	up to 5 days
Beef.....	up to 7 days
Game.....	up to 7 days

BIOFRESH COMPARTMENT

Humid setting

Vegetables, salad:

Artichokes	up to 21 days
Asparagus	up to 14 days
Broccoli.....	up to 14 days
Brussels sprouts	up to 30 days
Cabbage.....	up to 180 days
Carrots.....	up to 150 days
Cauliflower.....	up to 21 days
Celery.....	up to 30 days
Chicory	up to 30 days
Chinese cabbage	up to 14 days
Curly kale	up to 14 days
Fennel	up to 21 days
Garlic.....	up to 180 days
Green onions.....	up to 7 days
Herbs.....	up to 30 days
Iceberg salad, endives, lamb's lettuce	up to 21 days
Kohlrabi	up to 14 days
Leeks.....	up to 60 days
Lettuce.....	up to 10 days
Mushrooms	up to 7 days
Peas	up to 10 days
Radicchio	up to 21 days
Radishes	up to 14 days
Savoy cabbage.....	up to 60 days
Spinach	up to 7 days

Fruit:

Apples	up to 180 days
Apricots	up to 14 days
Bilberries	up to 14 days
Blackberries	up to 8 days
Cherries, black and red.....	up to 14 days
Currants.....	up to 21 days
Dates (fresh)	up to 60 days
Figs (fresh)	up to 7 days
Gooseberries	up to 21 days
Grapes.....	up to 90 days
Kiwi fruits	up to 120 days
Peaches	up to 30 days
Pears	up to 120 days
Plums	up to 21 days
Guinces	up to 90 days
Raspberries.....	up to 5 days
Rhubarb	up to 21 days
Strawberries	up to 5 days

The following products should not be stored in the BioFresh compartment:

cold-sensitive vegetables like cucumber, peppers, aubergines, avocados, semi-ripe tomatoes, beans, zucchini, and all cold-sensitive tropical fruits.

BIOFRESH COMPARTMENT

Arranging Food - Figure 3

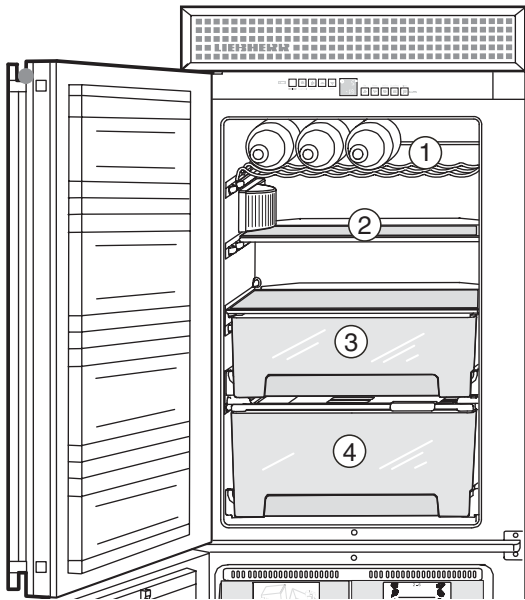

Figure 3

- (1) Beverage Rack, rack for standard-size champagne bottles and champagne miniatures
- (2) Butter, cheese, eggs, cans, drinks, bottles, preserves, dairy products, baked goods
- (3) Meat and sausage products, fish, pre-cooked meals, packaged foods
- (4) Salad, vegetables and fruit (BioFresh Drawer, humidity controlled)

IMPORTANT

- Liquids and food which give off or absorb odors and flavors should always be stored covered or in closed containers.
- High-percentage alcohols should be tightly sealed and stored upright.
- Fruit, vegetables and salad can be stored unpacked in the bins.

Store food so the air can circulate freely around the food. Do not store goods too close together.

- Food which gives off or absorbs odors and flavors, and liquids should always be stored covered or in closed containers.
- Always store food which gives off or is sensitive to ethylene gases, such as fruit, vegetables and salads, separately or wrapped in order not to affect their storage life. Example: Do not store tomatoes together with kiwis or cabbage.

Shelf Arrangement



WARNING

To avoid possible injury, only adjust an empty shelf. Do not attempt to adjust a shelf with food on it.

Repositioning the shelf - Figure 4

If you need space for large bottles and containers, lift the front half of the split glass shelf and carefully slide it under the back half until the stops click into the recesses.

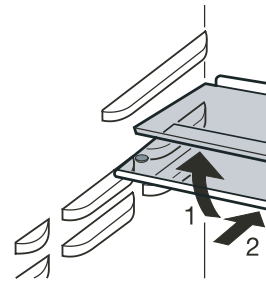

Figure 4

BIOFRESH COMPARTMENT

Drawer - Figure 5

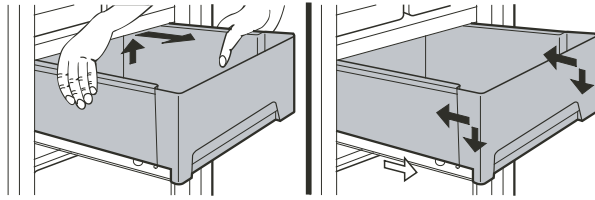

Figure 5

To remove the drawers:

Pull the drawer straight out, grip at the back and lift out.

To install the drawers:

Place the drawer on the rails. The rails must be fully extended and aligned with the front of the drawer. Slide the drawer in.

Interior Light - Figure 6

This turns OFF automatically after the door has been opened for approximately 15 minutes. If it does not turn ON when the door is opened briefly, but the temperature display is working, the bulb may be defective.

Bulb data:

120 V, Maximum wattage - 25 W
Bulb fitting - E14

Current and voltage must agree with details on the model plate.

Replacing the bulb:

WARNING



To prevent possible injury due to an electrical shock, be sure to disconnect the power cord or turn OFF the circuit breaker before replacing the interior light bulb(s) or cleaning the appliance.

CAUTION

To prevent possible injury due to broken glass, use hand protection when replacing the interior light bulb(s).

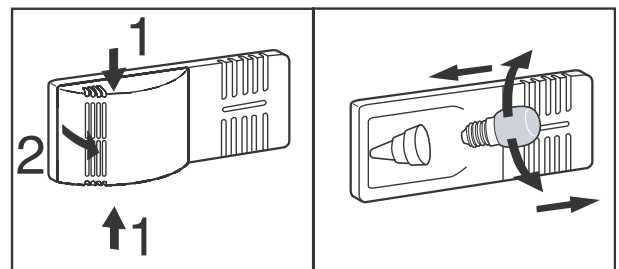

Figure 6

- Press the light cover together at the sides (1), lift out and unclip (2).
- Replace the bulb.
- Clip the back end of the cover in and clip the sides into place.

FREEZER COMPARTMENT

Freezing, Storage - Figure 1

Fresh food should be frozen completely and as rapidly as possible. Frozen food can also be given a cold boost. This is provided by the SuperFrost feature and ensures that the nutritional value, appearance and flavor of the food remain intact.

Freezing with SuperFrost - Figure 1

- Press the SuperFrost button (Fig. 1, 4) briefly so the SuperFrost button is lit. The SuperFrost function will be activated as long as the button is lit. The freezer temperature will decrease and the appliance will change to the lowest temperature.
- For small amounts of frozen food, it is normally sufficient to turn ON SuperFrost six hours beforehand. For the **maximum** amount you will need to turn it ON 24 hours before.
- Then place the fresh food inside the freezer, preferably in the top drawers. If freezing the maximum quantity of food, DO NOT use the drawers; instead, place the wrapped food directly on the glass shelves. Once the food is frozen, you can place it into the drawers.
- The SuperFrost function turns OFF automatically. Depending on the quantity of food placed in the freezer, this will normally be between 30 and maximum of 65 hours. The freezing process is now complete; the SuperFrost button will no longer be lit, and the freezer will change back to normal energy-saving operation.













IMPORTANT

You should not turn ON the SuperFrost function:

- when placing frozen food in the freezer;
- when freezing up to approximately 4-1/2 lbs (2 kg) fresh food daily.

Information System - Figure 7

Use frozen food within the recommended period. The numbers between the symbols indicate the storage period in months for different kinds of frozen foods. Storage times given are guidelines for food frozen at home. Whether or not the lower or upper value is applicable depends on the food quality and how it was processed prior to freezing. The lower values always apply to food with a high fat content.

pre-cooked meals		2 - 6		sausages
ice-cream				bread
fish		4 - 8		mushrooms
pork				game
vegetables		6 - 12		poultry
fruit				beef/veal

1

Figure 7

Freezer Tray* - Figure 8

The freezer tray allows individual freezing of berries, herbs, vegetables and other small goods. It prevents foods from freezing together.

Items being frozen will retain more of their shape, and it will be easier to remove exactly the right quantity later for use.

1. Spread the items out loosely on the tray.
2. Suspend the freezer tray in one of the top drawers. Freeze for 10 to 12 hours, then transfer to a freezer bag or container and place in a drawer.

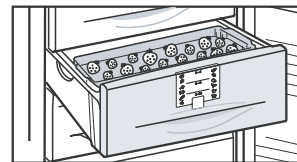

Figure 8

* Depending on model and options

FREEZER COMPARTMENT

Freezing and Storage

Do Not Freeze:

Lettuce, radishes, grapes, whole apples, pears, and fatty meat.

Food to Freeze:

Meat, game, poultry, fresh fish, vegetables, fruit, dairy products, bread, baked goods, pre-cooked meals.

- Pack frozen food in standard freezer bags or reusable plastic, metal or aluminum containers.
- Do not allow fresh food which is to be frozen to come into contact with food already frozen. Always keep packages dry in order to avoid them sticking together.
- Always write the date and contents on the package and do not exceed the stated storage time for the food. This prevents spoiling.
- Pack food which you are freezing yourself in quantities right for your household. To ensure the food freezes right through quickly, the following quantities should not be exceeded per package:
 - fruit, vegetables: up to 2-1/4 lbs (1 kg);
 - meat: up to 5-1/2 lbs (2.5 kg).
- Blanch **vegetables** after washing and cutting them. (Add to boiling water for 2-3 minutes, remove and quickly cool down in cold water. If you blanch with a steamer or microwave oven, please follow the operating instructions.)
- Do not salt or season fresh food or blanched vegetables before freezing. Only lightly salt and season other food. Some spices can alter their flavor intensity.
- Do not freeze bottles and cans which contain carbonated drinks as they might burst. Drinks can be cooled down quickly, but take the bottles out of the freezer compartment after an hour at the most.
- Only take out as much food as needed for thawing. Cook food which has been thawed as quickly as possible. Frozen food can be thawed in the following ways:
 - in a microwave oven
 - in the refrigerator: the safer way to thaw food because there is less chance of bacteria growth. Use this method for high density food such as roasts or poultry.

- Flat portions of meat or fish can be cooked when partially thawed.
- Vegetables can be cooked from frozen (in half the normal time).

Storage - Figure 9

Each drawer and shelf can take up to 55 lbs (25 kg) of frozen food.

By removing a drawer and a shelf you can create a double height space for big items of frozen food. This allows you to freeze things like poultry, large pieces of meat or large cakes without first having to cut them up, so they can be served "whole" afterwards.

If you want to use the maximum net capacity, you can remove the drawers and store items directly on the shelves.

- Always leave the bottom drawer in the appliance.

If you removed the top drawer, do not cover the fan openings at the back, otherwise the freezer will not work properly.

Removing Drawers

Pull forward until the drawer stops and lift out.

Removing and Installing the Shelves

Lift the shelf up at the front and pull out. To install, proceed in reverse and simply push the shelf in as far as it will go.

- Always store identical food items together to avoid the door being open for unnecessary long periods and to save energy.
- Do not exceed storage times given.

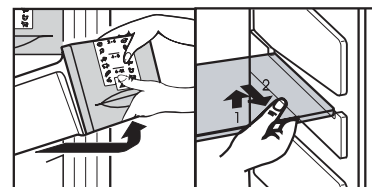

Figure 9

* Depending on model and options

ICEMAKER

To Start the IceMaker - Figure 10

The IceMaker will only work if the combined refrigerator-freezer is connected to the electrical outlet. It will only make ice cubes if the freezer compartment is operating.

The IceMaker is in the top left drawer in the freezer compartment of the combined refrigerator-freezer. You can identify this drawer by its labeling "IceMaker."

To turn on

- Pull out the drawer.
- Press the "ON/OFF" button so the control lamp comes on (**Figure 10**).
- Close the drawer.

Note

The icemaker can only make ice cubes if the drawer is completely closed.

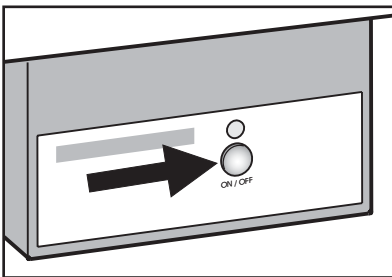

Figure 10

To turn off

If you do not need any ice cubes, the icemaker can be turned off independently of the freezer compartment.

- Press the "ON/OFF" button for approximately 1 second so the control lamp goes out.

Note

If the icemaker is turned off, the empty drawer can also be used to freeze and store food.

To make ice cubes

After you start the icemaker for the first time it may take up to 24 hours before the first ice cubes are ready.

Note

The first three batches of ice must not be consumed or used.

The production capacity depends on the temperature inside the freezer compartment. The lower the temperature, the more ice can be produced over a period of time.

The ice cubes fall out of the icemaker into the drawer. When the ice reaches a certain level in the drawer, the appliance stops producing ice automatically.

If you need a large quantity of ice you can change out the drawer to the right with the complete "IceMaker" drawer. When you close the drawer the icemaker will immediately start production.

To Clean the IceMaker - Figure 11

The IceMaker (arrow in **Figure 11**) can be cleaned by using this procedure.

1. Pull out the drawer and remove the ice.
2. Clean the drawer with warm water and mild dish detergent.
3. To access the IceMaker for cleaning:
 - a. With the drawer pulled out, press and hold the "ON/OFF" button until the LED goes out (takes about 1 second).
 - b. Continue to hold the button and after 10 seconds the LED will start to flash.
 - c. Insert the drawer while the LED is flashing. The IceMaker should rotate down into the cleaning position.
 - d. Remove the drawer.
4. Clean the IceMaker with warm water. If you need to use a cleaning aid, use a mild dish detergent and rinse. **You will need to throw out the first three batches of ice if you use any soap.**
5. Push the "ON/OFF" button until the LED lights and insert the drawer.
6. **Throw out the first three batches of ice to remove any soap residue.**

Note

If you need to leave the IceMaker off, clean the IceMaker but do not push the "ON/OFF" button in Step 5.

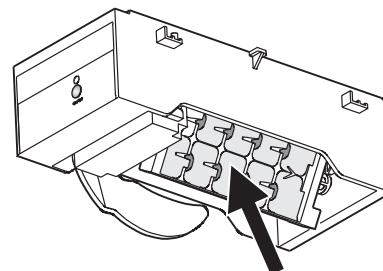

Figure 11

* Depending on model and options

DEFROSTING/CLEANING

Defrosting - Figure 12

The BioFresh compartment defrosts automatically. The water that forms on the rear wall drains into a reservoir at the back of the appliance and evaporates automatically through the compressor heat.

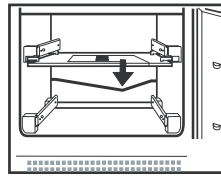

Figure 12

Ensure the defrost water can flow freely through the drain hole in the rear wall (**Figure 12**).

Cleaning - Figure 12-13

WARNING



- To prevent possible injury due to an electrical shock, be sure to disconnect the power cord or turn OFF the circuit breaker before replacing the interior light bulb(s) or cleaning the appliance.
- To avoid injury or damage, DO NOT use steam cleaning equipment to clean the appliance.

Clean the appliance by hand with lukewarm water and a little detergent. **DO NOT** place components in a dishwasher to clean.

DO NOT use abrasive or scouring sponges. **DO NOT** use concentrated cleaning agents. **NEVER** use abrasive or acid cleaners or chemical solvents.

Keep your stainless steel looking new by cleaning with a good quality stainless steel cleaner or polish monthly. High quality stainless steel cleaners and conditioners are commercially available.

DO NOT CLEAN WITH STEEL WOOL PADS or ABRASIVE PADS. DO NOT use cleaners that are not for use on stainless steel, such as glass, tile or counter cleaners. These types of cleaners can damage the surface permanently.

Stainless steel that is exposed to chlorine gas and moisture may have some discoloration. This discoloration is normal. If your unit is used in this environment, clean and polish your stainless steel more often.

If the surface discolors or rusting appears, clean it quickly with a non-abrasive cloth and protect it. Always clean and polish in the direction of the grain and finish.

To clean the storage shelves:

Figure 13. Lift the shelves, slide forward and remove.

Always insert shelves with the guard bar at the back pointing upwards, otherwise food may freeze onto the rear wall.

The glass shelves are designed to prevent the shelves from being pulled out accidentally.

To clean the BioFresh drawers:

Figure 13. Pull the drawers out and grip at the back, and lift out.

To reinstall:

- place the drawers on the extended rails, the rails must align with the front of the drawer and slide in.
- pull the drawer cover out towards you. When reinstalling, make sure the bearing pins snap into place in the grooves.

The drawer and the cover must be flush with one another vertically.

Clean the drain hole (Fig. 13) in the rear wall frequently. If necessary, clean with a thin object, like a cotton swab or something similar.

- Ensure no cleaning water penetrates into the electrical components or ventilation grille.
- Dry all parts well with a cloth.

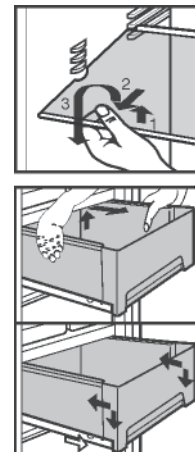

Figure 13

DEFROSTING/CLEANING

- Remove dust from the refrigerator unit and heat exchanger and the metal grid at the back of the appliance. This should be done at least once a year.



Figure 14

- **DO NOT** damage or remove the model plate on the inside of the appliance. It is very important for servicing your appliance.

Vacation Tips

Short vacations:

It is not necessary to turn OFF the refrigerator and freezer if you will be away for less than four weeks.

- Use all perishables.
- Freeze other items.
- Turn OFF the icemaker.
- Shut off the water supply to the icemaker.

Long vacations:

If you will be away for a month or more:

- Remove all food from the refrigerator and freezer compartments.
- Turn OFF the refrigerator and freezer compartments.
- Clean the appliance. Refer to **Cleaning**.
- Leave the door open to prevent unpleasant odors. This will also keep mold from building up.
- Turn OFF the icemaker.
- Shut off the water supply to the icemaker.

TROUBLESHOOTING

Your appliance is designed and manufactured for a long life and reliable operation.

that even during the warranty period, some repair costs may be your responsibility.

If a problem occurs during operation, check whether it is due to an operating error. Please note

You may be able to correct the following faults by checking the possible causes yourself:

Problem	Possible Cause and Remedy
Appliance does not work, display is OFF	<ul style="list-style-type: none">- Is the appliance turned ON properly?- Is the power source plug properly inserted in the socket?- Is the circuit breaker or fuse in operating condition?
The interior light does not come ON	<ul style="list-style-type: none">- Is the refrigerator compartment turned ON?- Has the door been open for more than 15 minutes?- The bulb is defective. Change the bulb as described in Interior light.
Loud running noise	<ul style="list-style-type: none">- Is the appliance standing firmly on the floor, or does the compressor cause nearby items of furniture or objects to vibrate? If necessary, move the appliance slightly, align by adjusting the adjustable feet, or move bottles and containers apart. <p>Normal Sounds: Flow noises, bubbling or dripping noises are from the refrigerant flowing in the refrigerant circuit. A short clicking sound can be heard whenever the refrigeration unit (the motor) automatically switches ON or OFF. The motor noise will be slightly louder for a brief period when the refrigeration unit switches ON. The refrigerating capacity will increase when the SuperFrost function is activated, fresh food has just been placed in the appliance or the door has been left open for a while. A low-pitched humming sound is caused by air flow noises in the fan.</p>
Motor seems to run too long	<ul style="list-style-type: none">- Is the ambient temperature too hot? See Safety Regulations.- Has the appliance been opened too often or left open too long?- A large amount of food has been added.- Unit is in Supercooling mode. Verify unit is in normal operation mode.
Alarm sounds, the temperature is not cold enough	<ul style="list-style-type: none">- Is the temperature setting correct? See Setting The Temperature.- Is the door closed properly?- Has an excessive amount of fresh food been placed in the appliance?- Does a separately installed thermometer show the correct reading?- Is the unit ventilated properly? Clean ventilation grilles.- Is the appliance set up too close to a heat source?
<i>nF</i> appears in the display	There has been a power failure; proceed as described in Power Failure/Frost-Control Display .
Icemaker cannot be turned on.	Is the combined refrigerator-freezer connected to the electrical outlet?
Icemaker is not making any ice.	<ul style="list-style-type: none">- Is the icemaker turned on?- Is the water supply line open?- Is the icemaker drawer closed properly?

* Depending on model and options

WARRANTY

Customer Service - Figure 1



If none of the above causes apply and you cannot correct the fault yourself, or if the temperature display reads "F1" to "F5", this means there is a fault. Please contact your nearest customer service department (see enclosed list for addresses).

Give the **fault number displayed**, together with the

**Type Designation (Fig. 1, 29),
Service Number / Serial number (Fig. 1, 30)
Appliance Number (Fig. 1, 31)**

as given on the model plate, to ensure prompt, accurate servicing. The model plate is located inside the appliance on the left-hand side.

Leave the appliance closed until the customer service engineer arrives to prevent any further cold loss.

Appliance Information

Record this information when the appliance is installed.

Type Designation: _____

Service/serial Number: _____

Appliance Number: _____

Date of Purchase: _____

Where Purchased: _____

LIEBHERR WARRANTY PLAN

FULL TWO YEAR WARRANTY - For two years from the date of original purchase, your Liebherr warranty covers all parts and labor to repair or replace any part of the product which proves to be defective in materials or workmanship.

FULL FIVE YEAR WARRANTY - For five years from the date of original purchase, your Liebherr warranty covers all parts and labor to repair or replace any components that prove to be defective in materials or workmanship in the sealed system. The "Sealed System" means only the compressor, condenser, evaporator, drier and all connecting tubing.

LIMITED 6TH THROUGH 12TH YEAR WARRANTY - From the 6th through 12th year from the date of original purchase, your Liebherr warranty covers all parts that prove to be defective in materials or workmanship in the Sealed System (parts only).

TERMS APPLICABLE TO EACH WARRANTY

All service provided by Liebherr under the warranty must be performed by authorized Liebherr service representatives, unless otherwise specified by Liebherr. Service will be provided in the home during normal business hours. This warranty applies only to products installed for normal residential use. Details regarding a non-residential warranty are available on request.

The warranty applies only to products installed in Canada and any one of the fifty states of the United States or the District of Columbia. This warranty does not cover any parts or labor to correct any defect caused by negligence, accident or improper use, maintenance, installation, service or repair, including but not limited to improper removal and reinstallation of the condensing unit.

The remedies described above for each warranty are the only ones which Liebherr will provide, either under these warranties or under any warranty arising by operation of law. Liebherr will not be responsible for any consequential or incidental damages arising from the breach of these warranties or any other warranties, whether express, implied or statutory.

Some states do not allow the exclusion or limitation of incidental or consequential damages so the above limitation or exclusion may not apply to you. This warranty gives you specific legal rights and you may also have other rights which vary from state to state.

To receive parts and/or service and the name of the Liebherr authorized service representative nearest you, contact your Liebherr dealer or distributor or contact the Liebherr designated national service provider:

in the US: Liebherr@adcoservice.com, or call 1-866-LIEBHERR or 1-866-543-2437

in Canada: www.euro-parts.ca, or call 1-888-LIEBHERR, 1-888-543-2437.

Free Manuals Download Website

<http://myh66.com>

<http://usermanuals.us>

<http://www.somanuals.com>

<http://www.4manuals.cc>

<http://www.manual-lib.com>

<http://www.404manual.com>

<http://www.luxmanual.com>

<http://aubethermostatmanual.com>

Golf course search by state

<http://golfingnear.com>

Email search by domain

<http://emailbydomain.com>

Auto manuals search

<http://auto.somanuals.com>

TV manuals search

<http://tv.somanuals.com>