



USB WIZARD

8 User USB-Switch

INSTALLATION / USER GUIDE

MAN035 Rev Date 5/6/2003

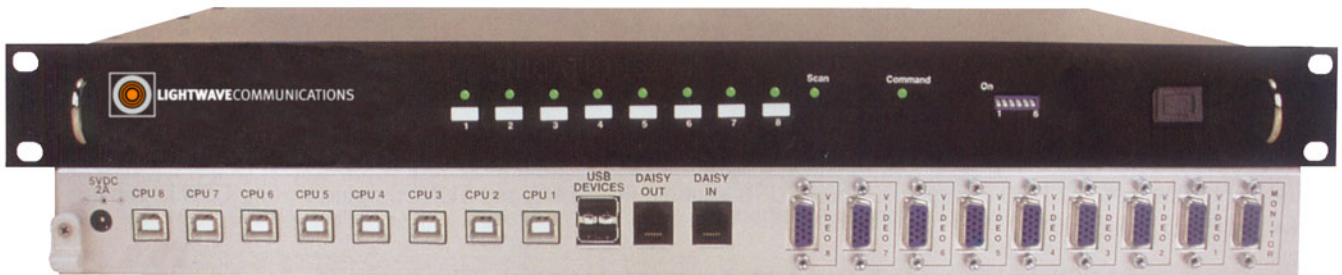

WARRANTY INFORMATION

The warranty period on this product (parts and labor) is one (1) year from the date of purchase. Please contact Lightwave Communications at **+49 (0)89 306381-0** or **office@lightwave.de** for information regarding repairs and/or returns. A return authorization number is required for all repairs/returns.

COPYRIGHT

Copyright © 2003 by Lightwave Communications. All rights reserved. No part of this publication may be reproduced, stored in a retrieval system, or transmitted, in any form or by any means, electronic, mechanical, photocopying, recording, or otherwise, without the prior written consent of Lightwave Communications, Zaubzerstrasse 11 • D-81677 Munich - Germany

CHANGES

The material in this guide is for information only and is subject to change without notice. Lightwave Communications reserves the right to make changes in the product design without reservation and without notification to its users.

TABLE OF CONTENTS

INTRODUCTION.....	1
Available Options.....	1
Types of User Input Devices Supported.....	1
MATERIALS.....	1
Materials supplied with this kit.....	1
Materials <i>Not</i> supplied but <i>REQUIRED</i>	1
DEFINITIONS.....	2
FEATURES AND FUNCTIONS.....	3
INSTALLATION.....	4
Power-Up Sequence.....	6
Limitations.....	6
CASCADING.....	7
Configuration.....	7
Cascaded Installation.....	7
Limitations.....	8
USING THE USB Wizard KVM SWITCH.....	9
Front Panel Control.....	9
Keyboard Control.....	9
MODES OF OPERATION.....	9
Basic Command Mode.....	9
OSD CONTROL.....	10
Security Option.....	10
Enabling the Security Feature.....	10
User Login Mode.....	11
ADDITIONAL MODES AVAILABLE WITH SECURITY.....	11
Administration Mode.....	11
Administrator Password.....	12
User Name List.....	12
System Access List.....	13
USER ACCESS FUNCTIONS.....	13
OSD Command Mode.....	13
Scan Mode.....	15
Normal Mode.....	15
Edit Mode.....	15
Search Mode.....	16
Maintenance Mode.....	16
Help Mode.....	17
KEYBOARD FEATURES.....	18
Keyboard-To-Computer Translation.....	18
Translation Capabilities.....	18
Translation Tables.....	18
HOW TO DISABLE OPERATING MODES.....	20
Configuring The Jumper Block.....	21
TROUBLESHOOTING.....	22

TABLE OF FIGURES

Figure 1- Connect a VGA multi-scan monitor	4
Figure 2- Connect the device(s).....	4
Figure 3- Connect the AC adapter	5
Figure 4- Connect each CPU	5
Figure 5- Compatible and incompatible device combinations.....	6
Figure 6- Connections for Cascading.....	7
Figure 7- Master-to-Slave Device Cable Connections.....	8
Figure 8- Administrator Login screen	10
Figure 9- User Login screen.....	11
Figure 10- Administration Mode menu	11
Figure 11- Administrator Password screen	12
Figure 12- User Name List screen	12
Figure 13- System Access List screen.....	13
Figure 14- Command Mode screen	13
Figure 15- More Command Mode Features.....	14
Figure 16- Edit Mode screen.....	15
Figure 17- Search Mode screen.....	16
Figure 18- Maintenance Mode screen	16
Figure 19- Keyboard Layouts	19
Figure 20- Location of the jumpers block	20
Figure 21- Remove the philips-head screws.....	20
Figure 22- Get access to jumper block	21
Figure 23- Configure the jumper block.....	21

INTRODUCTION

The Lightwave Communication USB-Wizard USB KVM switch allows access to any Windows, MAC, or SUN USB CPUs from one monitor, USB keyboard and USB mouse (up to 8 CPUs as a single switch or 64 CPUs when cascaded). Internal microprocessor circuitry allows all USB CPUs to be booted simultaneously without keyboard error. Port selection is accomplished by front panel push buttons or commands typed on the keyboard. Port lights & status LEDs continuously update on the front panel.

Available Options

Switch models are available in 60 or 50 Hz, and 110 or 220V.

On Screen Display (OSD) Control feature will superimpose operating menus directly onto the monitor for security administration and control.

Types of User Input Devices Supported:

- USB keyboard with Windows layout
- USB keyboard with SUN layout
- USB keyboard with MAC layout
- USB Mouse - (up to 3 buttons)
- USB IntelliMouse (scrollwheel)
- USB Hub
- Mouse-trak trackball
- Logitech Cordless Elite Duo keyboard and mouse
- Crystal Vision keyboard with touchpad
- Gyration keyboard/mouse
- Lightwave Communications USB-PS/2 Adapter
- Lightwave Communications USB-SUN Adapter

Types of CPUs Supported:

Any USB CPU supporting USB version 1.0 or above including:

- USB WINxx
- USB MAC
- USB SUN

MATERIALS

Materials supplied with this kit:

- USB Wizard (8 ports) USB KVM Switch
- 120VAC/5VDC AC Adapter

Materials *Not* supplied but **REQUIRED**:

A USBVEXT-xx-MM cable for each USB CPU being connected to the switch must be used for monitor, keyboard and mouse interface.

where:

xx is the length of the cable in feet

MM indicates male-to-male connector

Cables can be purchased from Lightwave Communications by calling **+49 (0)89 306381-0**

DEFINITIONS

- USB Composite Device A USB device that contains multiple endpoints each representing input devices that cannot be separated (i.e. a keyboard with a built-in mouse)
- USB Hub A USB device that allows one or more USB input devices to plug in to the USB. The hub has exactly one upstream port with one or more downstream ports which input devices connect to
- CPU Enclosure that contains the operating system and processor (i.e. Sun with SPARCstation5, Windows 95 with Pentium II)
- Input Device Keyboard or Mouse
- System One or more CPUs connected to one or more switches controlled by one or more input devices

FEATURES AND FUNCTIONS

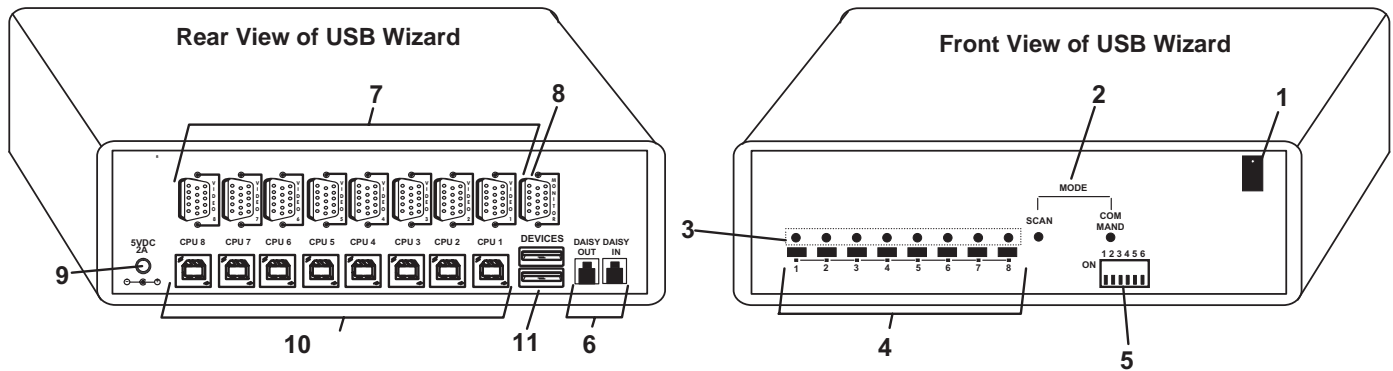

FEATURES AND FUNCTIONS

1. Power Switch- to power up or power down the USB Wizard USB KVM switch
2. Mode Status LEDs- for visual indication of switch operating mode
3. CPU Status LEDs- for visual indication of connection between the user and a specific CPU.
4. CPU Select Switches- push to manually switch to a specific CPU or change the switch operating mode
5. Dipswitches- for configuring cascaded switches
6. Daisy In/Out - for attaching interface cables (REXT-SR-xx) between slave switches and the master switch
7. VIDEO-x- 15HD female connectors- for connecting video cables from CPUs
8. MONITOR- 15HD female connector- for connection of the user video monitor
9. 5VDC- connection jack for the AC adapter
10. CPU x- USB type B female connector-for connection of USB device cable from CPU(s)
11. DEVICES- USB type A female connector- for connection of user USB device(s)

INSTALLATION

1. It is not necessary to turn the CPUs or monitors OFF during this installation.
2. Connect the cable from a VGA multi-scan monitor to the 15HD connector labeled "MONITOR" on the USB Wizard switch. (See Fig. 1 below.)

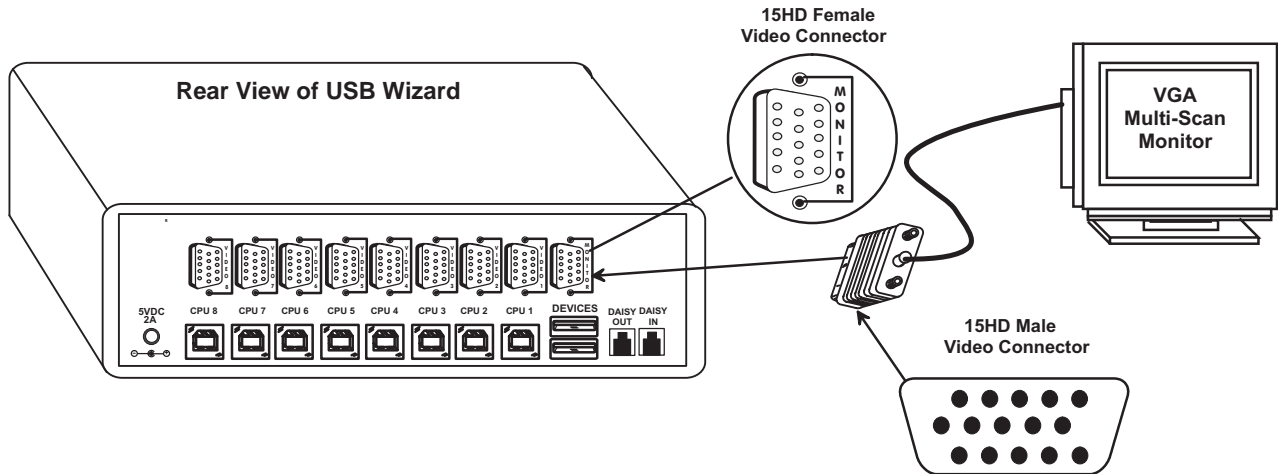

Figure 1- Connect a VGA multi-scan monitor

3. Connect the male USB type A connector on the keyboard cable to either one of the two USB type A female connectors labeled "DEVICES" on the rear panel of the USB Wizard.
4. Connect the male USB type A connector on the mouse cable to the remaining USB type A female connector labeled "DEVICES".

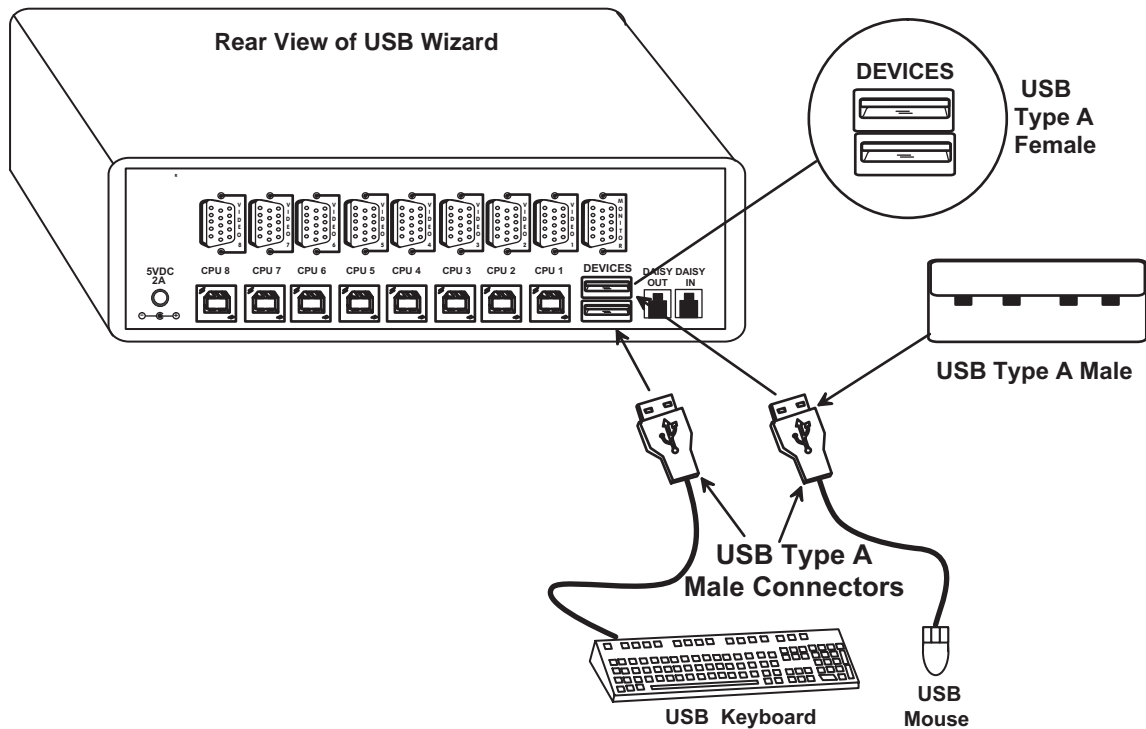

Figure 2- Connect the device(s)

- When cascading switches, configure dip-switches accordingly (see Tables 1 & 2 on page 8).
- Power-up the USB Wizard. (See Fig. 3 below.)

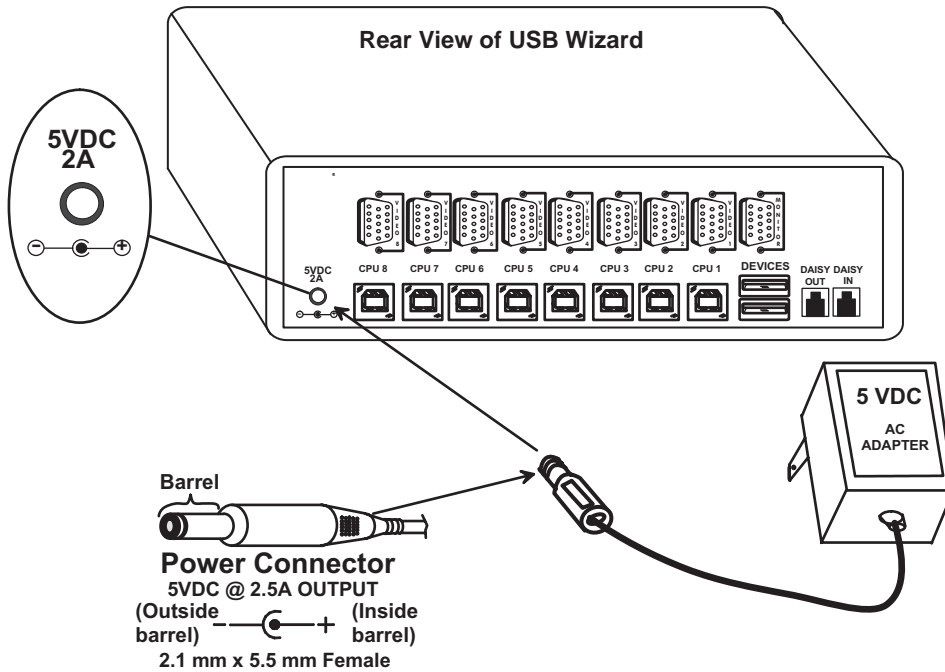

Figure 3- Connect the AC adapter

Note: Do not press any port buttons until the PORT 1 LED on the front panel of the switch illuminates.

- Connect each CPU to the USB Wizard using a USBVEXT-xx-MM video and input device interface cable – REQUIRED (not supplied). (See Fig. 4 below.)
- Group the input device and monitor interface cables from each CPU, making sure that cables from the first CPU are connected to the USB Wizard switch at connectors CPU 1 and VIDEO 1. Cables from the second CPU should connect to CPU 2 and VIDEO 2 connectors...etc.

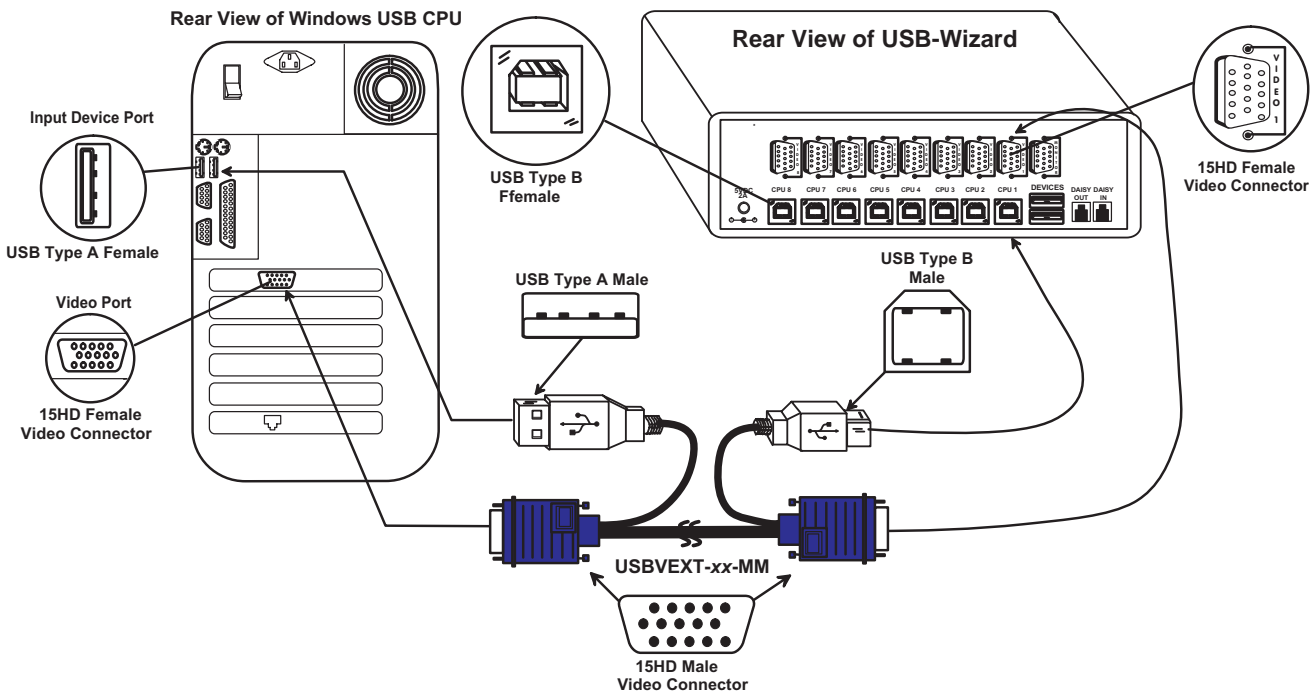

Figure 4- Connect each CPU

Power-Up Sequence

- The USB Wizard can be powered at any time.
- The CPUs can be powered at any time although if a CPU needs a keyboard and/or mouse at power-ON it should be powered after connecting to and powering-ON the USB Wizard.
- USB input devices (keyboard and mouse) can be hot plugged to and from the USB Wizard switch at any time.

If the security option is enabled (see page 12 for details on the "Security Option"), when the USB Wizard is powered up the user will be prompted for a username and password to continue. If the security option is not enabled the monitor will display the desktop image for the connected CPU and the user can continue with normal operation of the connected CPU.

Limitations

- Only USB input device or hub cables can be connected to the USB Wizard at the USB Type A female ports labeled "DEVICES". (See Features and Functions on page 3, item 11.)
- A USB hub (single or multi-port) can be used provided only USB input devices (except for MAC keyboards) are plugged into it.
- No additional hubs may be connected (as in a daisy-chain) to the hub that is directly connected to the USB Wizard.
- USB MAC keyboards with USB Type A female ports built into them are designed as hubs and must be treated as such with respect to the USB Wizard. As a result, USB MAC keyboards cannot be connected to a multi-port hub or other MAC keyboards connected directly to the switch.
- Only a USB Windows or SUN keyboard or USB mouse may be connected to the USB port on a USB MAC keyboard
- A maximum of 8 input devices may be connected to the USB Wizard either directly or through hubs.

See Fig. 5 for some examples of input device combinations that can and cannot be used with the USB Wizard.

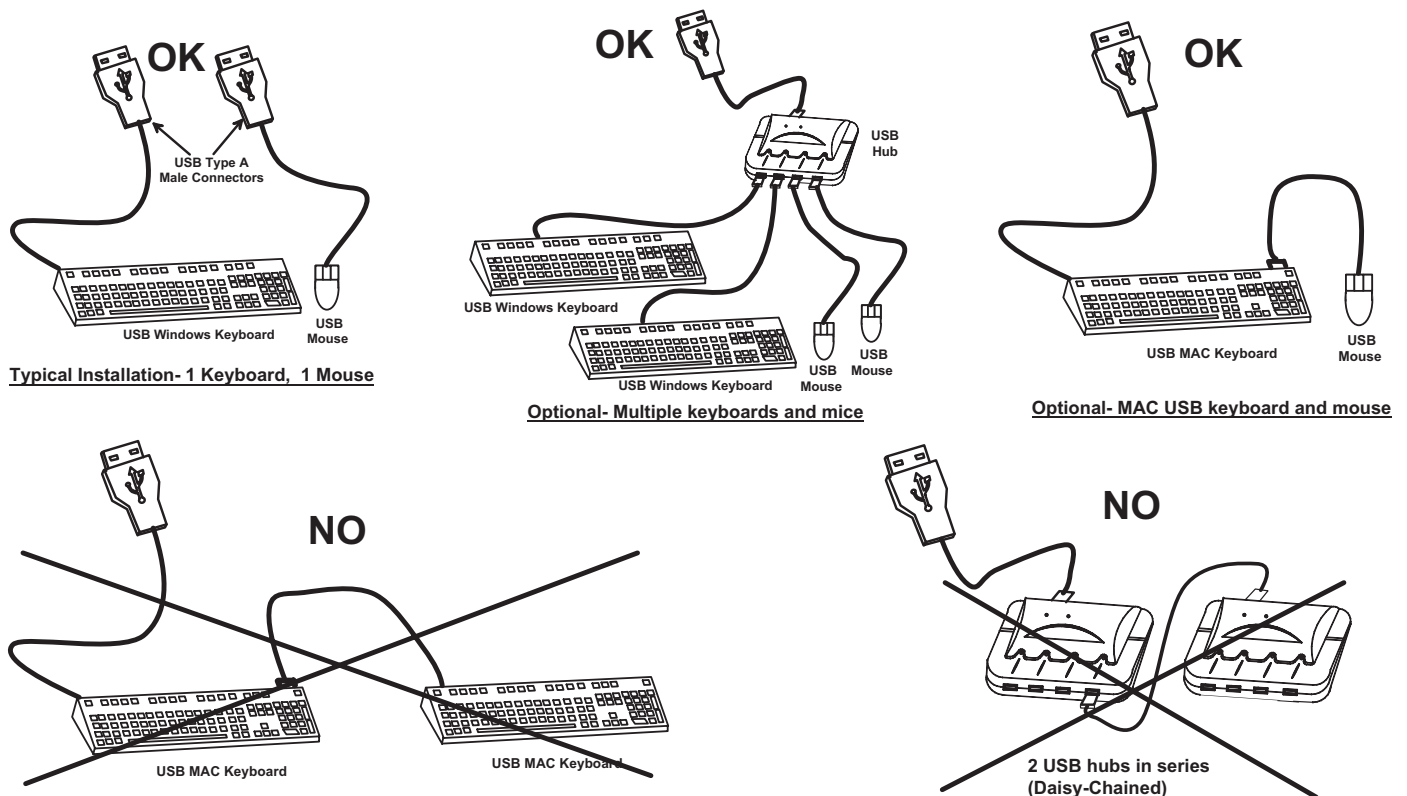

Figure 5- Compatible and incompatible device combinations

CASCADING

The USB Wizard can be cascaded as shown in Fig. 6 below. If USB Wizard switches are being cascaded, configure the dip-switches accordingly (see Tables 1 and 2 on page 8).

Configuration

All units are configured using the 6-position dip switch (located on the front of each unit) according to the tables on page 8 (1 & 2).

Cascaded Installation

- Configure each dip switch as per the tables on page 8 before proceeding.
- Using the 15HD video cable ends of a USBVEXT-xx-MM cable, connect the USB Wizard slave's MONITOR port to the master's VIDEO 1 port.
- Using the USB ends of the same USBVEXT-xx-MM cable, connect one of the USB slave's USB DEVICES ports to the master's CPU 1 port.

Note: Only one of the two ports labeled **DEVICES** on a slave needs to be used in order for cascading to work.

- Repeat step b. & c. for each additional slave, keeping in mind that each slave will connect to the next available master's port (i.e. Slave #2 to master's VIDEO 2 & CPU 2, etc.) See Fig. 7 on page 8.
- With a RMT extension cable, connect the master's DAISY OUT port to slave #2's DAISY IN port. Then connect slave #2's DAISY OUT to slave #3's DAISY IN. Continue until all slaves are connected together.

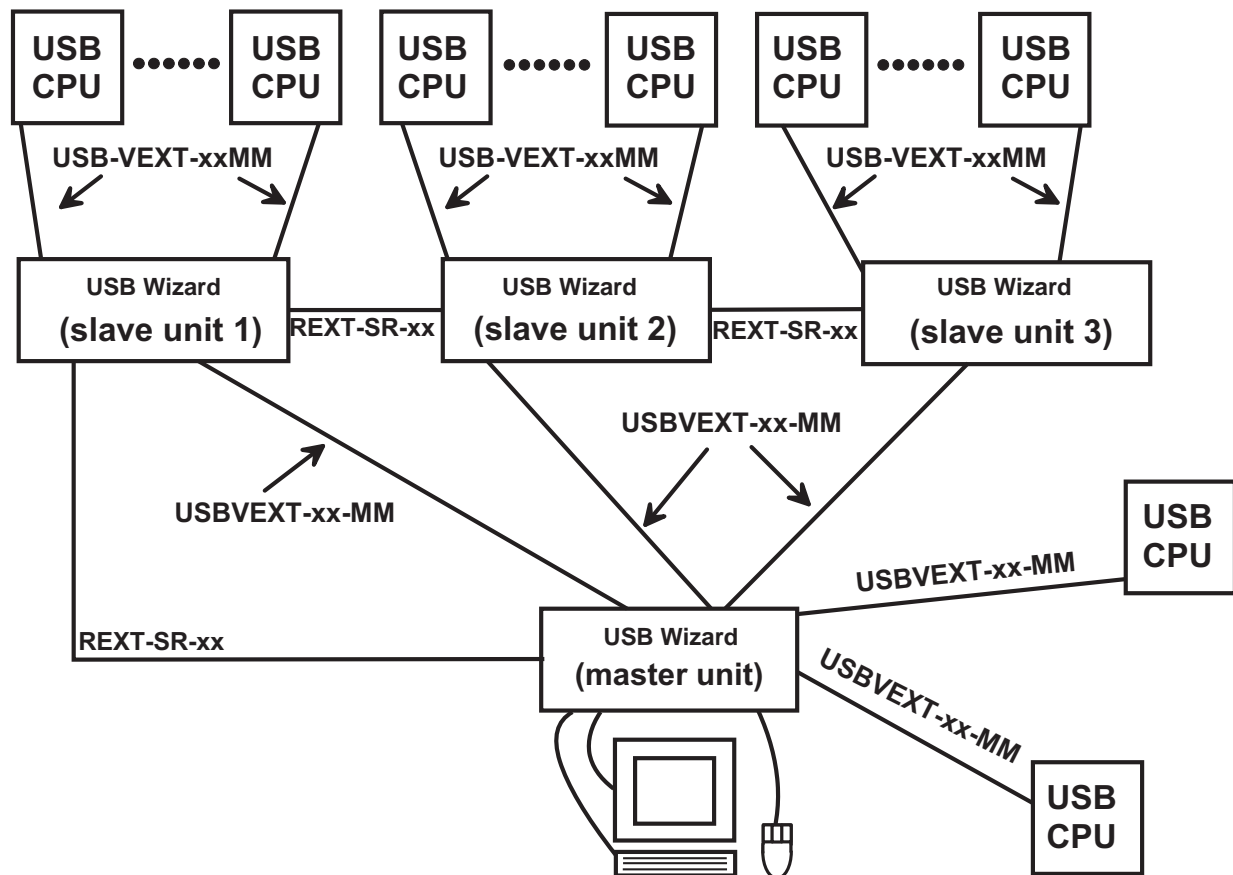

Figure 6- Connections for Cascading

Front Panel Configuration Switches

Switch	SW1	SW5	SW6
STAND-ALONE SWITCH	OFF*	OFF*	OFF*
SLAVE	ON	OFF	OFF
MASTER W/4-PORT SLAVES	OFF	OFF	ON
MASTER W/8-PORT SLAVES	OFF	ON	OFF
MASTER W/16-PORT SLAVES	OFF	ON	ON

SW2	SW3	SW4	Master with-	Slave Setting
OFF*	OFF*	OFF*	No Slave Attached	N/A
OFF	OFF	OFF	1 Slave attached	Slave #1
OFF	OFF	ON	2 Slaves attached	Slave #2
OFF	ON	OFF	3 Slaves attached	Slave #3
OFF	ON	ON	4 Slaves attached	Slave #4
ON	OFF	OFF	5 Slaves attached	Slave #5
ON	OFF	ON	6 Slaves attached	Slave #6
ON	ON	OFF	7 Slaves attached	Slave #7
ON	ON	ON	8 Slaves attached	Slave #8

These switch settings (Table 2) enable the slave to establish its identity (i.e. location in the group) to the Master.

Side Note: In a Master, the same switches are used to configure the Master for how many slaves are attached to it.

Note: All USB Wizard switches must be powered OFF during dip switch configuration

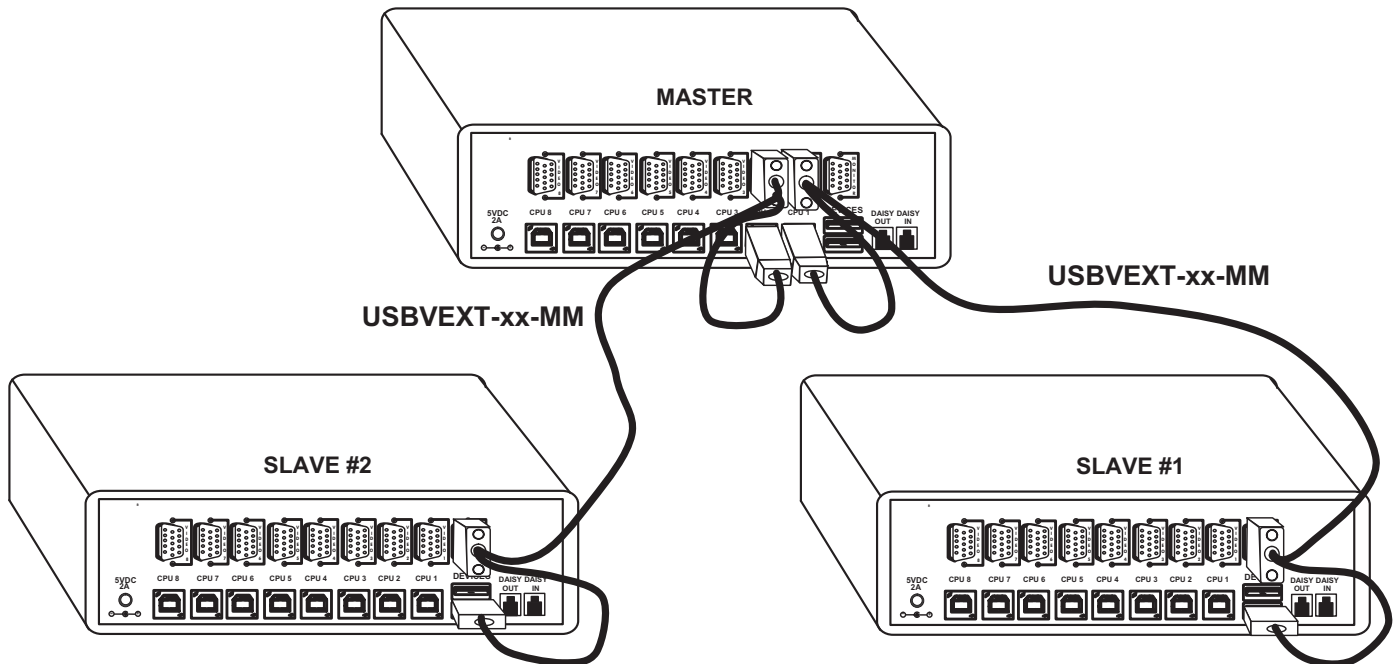

Figure 7- Master-to-Slave Device Cable Connections

Limitations

- All switches used as slaves must be the same size (all 8 port).
- Up to 8 slaves be connected to form a maximum system size of 64 ports.
- Slaves must be added to the master in order (slave #1 to master's port 1, slave #2 to master's port 2, etc).

Note: Master Port 1 (with an 8-port Slave connected to it) will become ports 1-8. Master Unit Port 2 (with a second 8-port Slave Unit connected) will become port numbers 9-16.

- All USB Wizard switches must be powered OFF during dip switch configuration.

USING THE USB WIZARD KVM SWITCH

Once the USB Wizard switch is properly connected, the USB Wizard will enable a connection to be made between the CPUs attached to its VIDEO and CPU ports and the monitor and input devices attached to the MONITOR and DEVICES ports. The LEDs on the control panel of the USB Wizard will illuminate depending on which port (and corresponding CPU) is being connected to the monitor and input devices.

The USB Wizard can be controlled by three methods:

- front control panel using touch-switches and LEDs
- keyboard control through Command Mode
- mouse clicks from within some menus of OSD Command Mode (optional).

Front Panel Control

There is a touch-switch and LED on the front panel of the USB Wizard for each CPU the switch will connect the monitor and input devices to. Pressing any touch-switch on the front panel of the USB Wizard will connect the corresponding CPU to the monitor and input devices.

Holding down any front panel touch-switch for more than 2 seconds will cause the USB Wizard to cycle through all modes of operation including COMMAND, SCAN, and NORMAL (described below and on page 11). The two MODE LEDs on the front panel indicate which mode is selected. Release the touch-switch when the LEDs indicate the desired mode. When no mode LEDs are illuminated the user is in Normal Mode controlling directly the CPU to which the user is connected through the USB Wizard.

Keyboard Control

Keyboard control of the USB Wizard can be achieved using either of two methods:



- **Basic Command Mode**- operated strictly by using keyboard commands as instructed below. Basic Command Mode is only applicable if the OSD option is not built into the switch.
- **OSD Command Mode** (optional)- operated using the keyboard and mouse in conjunction with OSD menus superimposed onto the monitor. If OSD is built in, use the menus as instructed on page 11.

By pressing <Ctrl> + < ` > (accent key), the user can enter Command Mode (either Basic, or OSD). Once in Command Mode, typing a series of commands will cause the USB Wizard to connect the user to any one CPU connected to the switch. Pressing the <Esc> key will exit Command Mode.

MODES OF OPERATION

Basic Command Mode

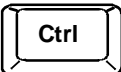
In order to control the USB Wizard with the keyboard connected, Command Mode must be enabled. To enter Command Mode from the keyboard:

Press  +  (ACCENT KEY)

OSD CONTROL

OSD superimposes a menu system on the user's video screen with a list of all connected CPUs. OSD allows CPUs to be named (with up to 12-character names). OSD then allows selection of CPUs by that name. Connected CPUs can be listed by name or by port number. OSD Search Mode enables the user to type in the first few characters of the CPU's name and the OSD will locate it. Help screens assist with all OSD functions.

Security Option

The security option of the OSD Control enables an administrator to control access to CPU ports for each user. Up to 24 users can be created. These users have controlled access to any CPU. Only the administrator can activate or deactivate the security features. Security can be activated from the Maintenance Mode menu (page 17) with a successful administrator login for verification purposes. Furthermore, the administrator can set a maximum idle time value after which the current user will be logged out and the login screen displayed. This time out does not function while the OSD is active. The current security status, idle time out, and scan dwell time are all saved and will be restored whenever power to the switch is cycled OFF, then ON. To reset the administrator's password call Lightwave Communications and have the device serial number of the USB Wizard available.

Enabling the Security Feature

To enable the security feature the administrator must first enter Command Mode from the keyboard using the sequence <Ctrl> + <'> (accent key). The OSD menu will automatically appear on the monitor in addition to illuminating the Command Mode indicator LED on the USB Wizard. This provides a visual way to control the USB Wizard using the keyboard and mouse.

The administrator, when setting the USB Wizard up for the first time, may want to proceed directly to the ADMINISTRATION Mode by typing <CTRL> +<M>, then <A>, and then <Y>.

The factory settings are:

- default user name = ADMINISTRATOR
- default password = ADMINISTRATOR

Note: The user name for the administrator cannot be changed from "ADMINISTRATOR".

Once logged-in, follow the instructions on page 12 for setting up users and changing the password. Once the password is setup, if it is lost or forgotten the administrator will have to contact Lightwave for assistance on clearing the password and set it up again. Within the Administration Mode the administrator can setup each of the users and the limitations of their use of the individual CPUs attached to the switch.

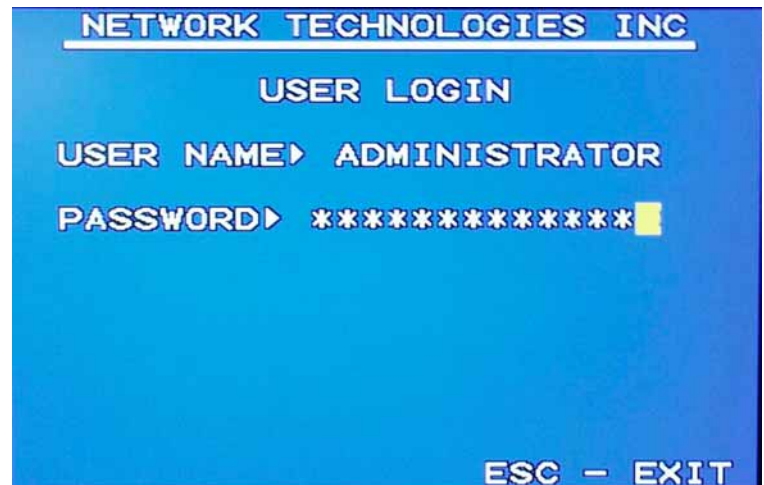

Figure 8- Administrator Login screen

When a standard user powers up the system a security screen will appear if security has been enabled by the administrator. The user will need to login to the switch by following the instructions on page 12 for the USER LOGIN. If the user does not know the appropriate user name and password (setup by the administrator), contact the switch administrator for this information. Once logged-in a user can follow the Command Mode functions described on page 14 to control the switch within the limitations as determined by the administrator.

User Login Mode

User login mode requires a user to login with a user name and password from the list created by the administrator. This mode will also disable use of the front panel until the user logs in.

Function:

Keystroke:

Adds a character to the user name/password



(Type any alphabetical or numeric character)

Removes previous character from the user name/password

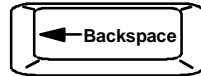

Submit user name/password

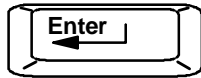

Exit USER LOGIN and return to previous mode. This function is only available if security is not currently active.

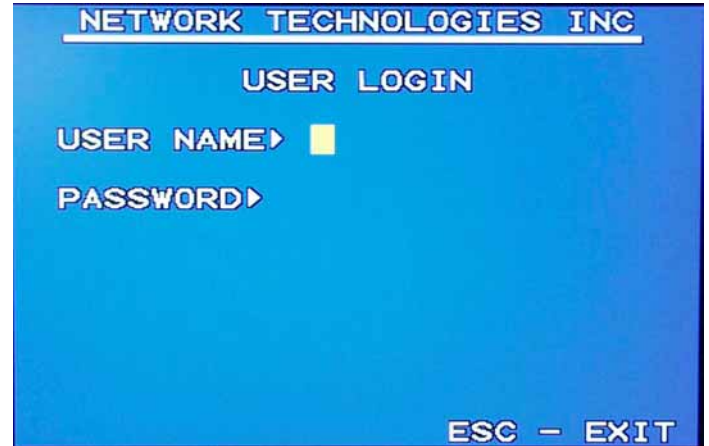

Figure 9- User Login screen

If the password submitted is incorrect, the user will not be able to proceed.

If the password submitted is correct, the user will proceed to Normal Mode.

ADDITIONAL MODES AVAILABLE WITH SECURITY

The three modes that follow are only available if the administrator is logged in.

Administration Mode

To enter the Administration Mode menu press <A> from the Maintenance Mode menu (page 10).

Administration Mode allows the administrator to use the following functions:

Function:

Keystroke:

Change the administrator's password



Disable security



Update User Name List



Toggle Language in menus between English and Italian



Selects the idle time in minutes

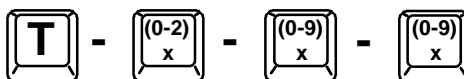

(xxx from 000 to 255. i.e. T002 would set the time-out period for 2 minutes. 000 will disable it)

Exit Administration Mode and return to previous mode

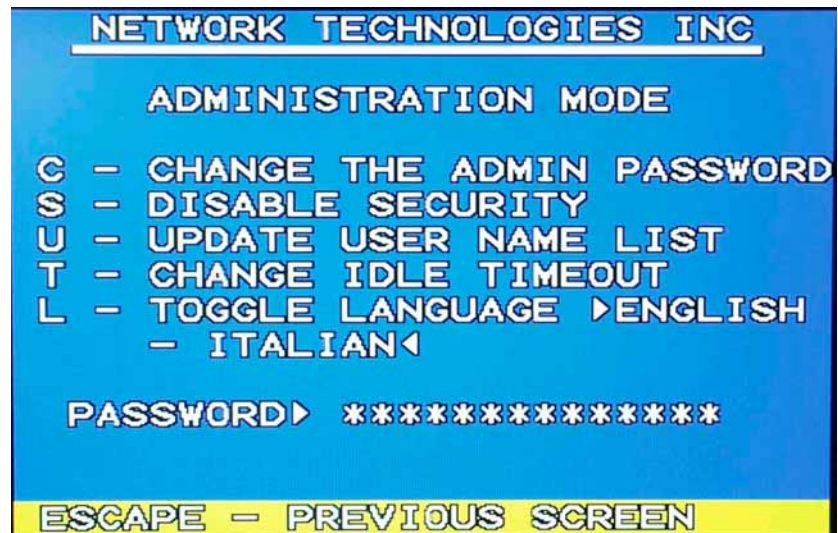

Figure 10- Administration Mode menu

Administrator Password

To change the administrator password press <C> from the Administration Mode menu.

The administrator is able to change the administrator password as needed (see Fig. 11). Two edit fields are available, one for password, the other for verify password. The password can be up to 13 characters in length.

Note: The default password for the administrator is ADMINISTRATOR.

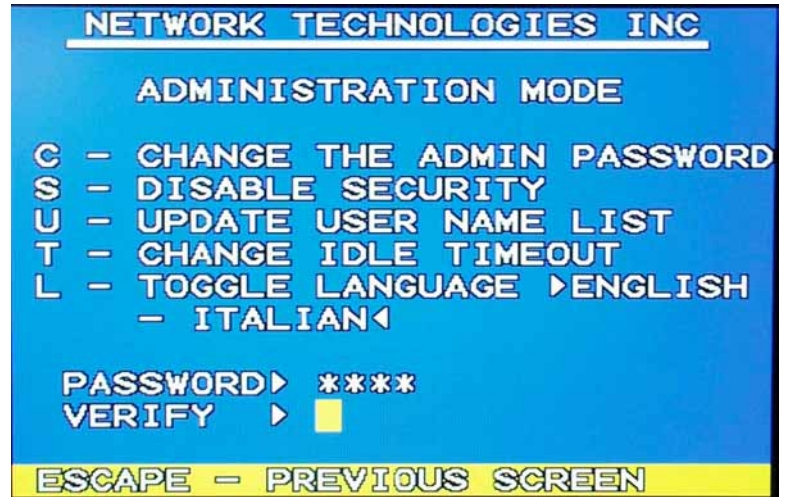

Figure 11- Administrator password change

Function:

Add character to password string or verify password string

Keystroke:

or + (Type any upper or lower case alphabetical or numeric character)

Delete previous character in edited string

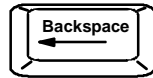

Save new password.

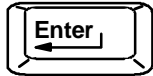

(If Password string and Verify Password string are different, this command will have no effect, enabling the administrator to correct the password)

Return to Administration Mode



User Name List

To enter the User Name List press <U> from the Administration Mode menu.

The User Name List displays the list of users and provides control for adding new users (up to 24), changing or assigning user passwords, and changing access rights for any given user. User names may be up to 12 characters long, may not contain spaces, and are not case sensitive. Passwords may be up to 15 characters long, may not contain spaces, and are case sensitive.

Function:

Edit the highlighted user's System Access rights

Keystroke:

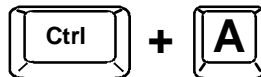

Enter Edit Mode to add/change/remove users

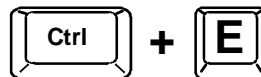

Change the highlighted user's password

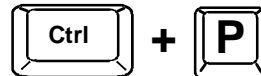

Exit the USER NAME LIST and return to previous mode

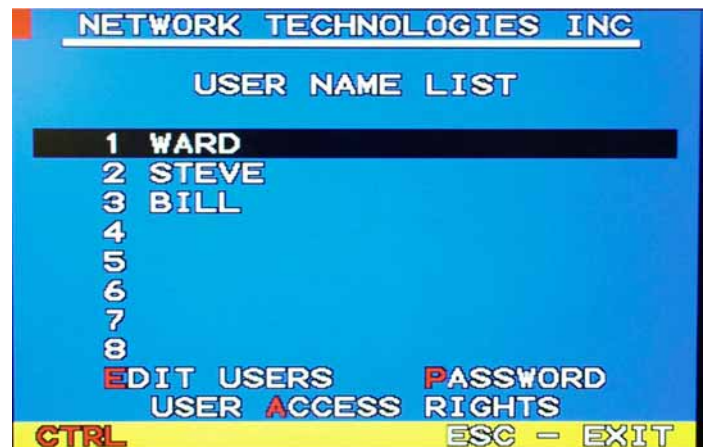

Figure 12- User Name List screen

System Access List

To enter the System Access List press <Ctrl> + <A> from the User Name List menu.

The System Access List displays a list of numbers representing the ports so the administrator can change access rights to the ports for the selected user. The user's name is displayed at the top of the access list. The mouse is used to change access rights by clicking on a given number to toggle a port's status. A user that has access to a port can connect to that port and control the CPU connected to that port when in Normal Mode.

Function:

Save the changes to the access list and return to previous mode

Exit the System Access List without saving and return to previous mode.

Keystroke:

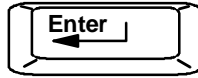

Figure 13- System Access List screen

USER ACCESS FUNCTIONS

INTRODUCTION

The OSD menu enables a user to name the CPUs connected to the USB Wizard and connect to them using that name from a single keyboard and mouse. The OSD is positioned on the user's monitor, displaying 8 CPU names at a time. The screen can be used for switching as well as editing the CPUs' names. Through the OSD menu, the user can operate the USB Wizard to have the switch cycle through 2 extended modes of operation: COMMAND and SCAN. Two LEDs on the front panel indicate when these modes are enabled.

OSD Command Mode

When entering the Command Mode from the keyboard using the <Ctrl> + <>`> (accent key), the OSD menu will automatically appear on the monitor in addition to illuminating the COMMAND indicator LED on the USB KVM switch. This provides a visual way to control the USB Wizard.

The list below describes the OSD Command functions available from the keyboard after entering Command Mode and while the COMMAND LED is illuminated:

Function:

Select the previous port

Select the next port

Enable/disable Scan Mode

Enter Edit Mode

Keystroke:

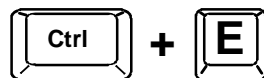
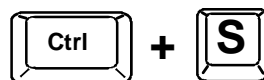
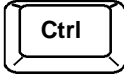

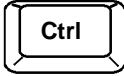



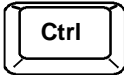











Figure 14- Command Mode screen

OSD Command Mode (Cont'd)

Function:

Keystroke:

Enter Maintenance Mode	 + 
Sets scan time-out on each port	 +  -  -  -  (xxx from 002 to 255. ie. t002 would set the time-out period for 2 seconds)
Selects a specific port	 +  -  -  (Pxx would be P01, P02, etc.)
Enters Search Mode and adds a character to search string and selects the CPU's name that matches best.	 (Type any alphabetical or numeric character)
Selects the first port on the switch	
Selects the last port on the switch	
Display Help Menu	
Switch to a selected port	
Exit OSD Command Mode	

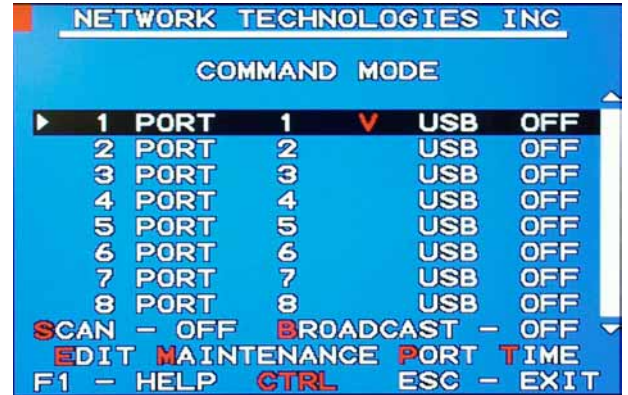

Figure 15- More Command Mode Features

Press <CTRL> while in the Command Mode menu to display the Edit, Maintenance, Port, and Timeout control features.

Note: The user must exit Command Mode to type to a CPU.

To exit Command Mode, either hold down any touch-switch on the front panel for more than 2 seconds, OR press <ESC> on the keyboard.

The mouse can also be used to control the USB Wizard within the Command Mode menu.

- The mouse cursor can be moved to the Scan, Help, and Exit fields where the user can then click on the left mouse button to perform that function.
- Ports listed on the screen can be selected by moving the cursor onto that port and clicking. Clicking twice on a selected port will switch to that port and exit Command Mode.
- To change the displayed ports on the screen simply click on the up and down arrows located to the right of the port names displayed.

Scan Mode

To activate Scan Mode press <Ctrl> + <S> from the Command Mode menu.

When in Scan Mode the switch scans to each port with a CPU powered-ON. (The SCAN LED on the front panel will illuminate and remain ON while in Scan Mode.) The port with the CPU powered-ON remains active while in use until it becomes idle for the configured dwell time (default time-out period is 5 seconds) before switching to the next powered-ON CPU port. See Command Mode section above for configuring the scan dwell time.

Note: The keyboard and mouse must remain idle for the full scan dwell time before the switch selects the next active port.

Note: The scan dwell time set by the user only effects that user and has no effect on other switch users.

Normal Mode

When the USB Wizard is not in Command or Scan mode and all of the USB KVM switch mode LEDs are OFF, the user is in Normal Mode, controlling the CPU to which the user is connected through the USB Wizard.

Edit Mode

To activate Edit Mode press <Ctrl> + <E> from the Command Mode menu.

Edit Mode enables the user to modify the names of the CPUs connected to the switch. Names of CPUs can be up to 12 characters in length. When in Edit Mode, multiple keystroke combinations are not valid (<Shift>+P, <Ctrl>+P, <Alt>+ P, and P will all type a "P" to the display - lower case letters cannot be typed).

Function:

Keystroke:

Move cursor one position to the right



Move cursor one position to the left



Move cursor to the previous port



Move cursor to the next port



Selects the first port on the switch



Selects the last port on the switch



Toggles between insert and overstrike



(The character either gets inserted and the remainder of the name gets shifted to the right, OR the current character gets overwritten.)

Erase current character



Erase previous character

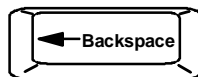

Figure 16- Edit Mode screen

When finished making changes in Edit Mode, press <Enter> and a prompt will appear to press either <Y> to save the changes or <N> to continue making changes without saving the changes just made. If the <Esc> key is pressed instead of <Enter>, all changes made will be ignored and the display will return to the previous menu.

Search Mode

To enter Search Mode, type any alphabetical or numeric character when the Command Mode menu is on the monitor.

Search Mode enables the user to enter and maneuver through a list of CPU names. The CPU name best matching the characters typed is selected. The list of CPUs may also be searched for a specific (or similar) name. The following commands are valid when the search option has been invoked from Command Mode.

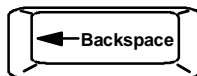

Figure 17- Search Mode screen

Function:

Erase previous character in search name

Keystroke:



Add a character to the search string and select the best matching CPU name



(Type any alphabetical or numeric character)

Exit Search Mode, return to Command Mode



Switch to selected port



Maintenance Mode

To enter Maintenance Mode press <Ctrl>+<M> from the Command Mode menu.

Maintenance Mode enables a user to customize the On Screen Display to their requirements.

Function:

Reset all of the port names

Keystroke:



Toggle between numeric and alphabetic listing of ports



Move On Screen Display (OSD) menu up on monitor



Move OSD menu down on monitor



Move OSD menu to the right



Figure 18- Maintenance Mode screen

Maintenance Mode (Cont'd)

Function:

Keystroke:

Move OSD menu to the left



Make OSD menu taller



Make OSD menu shorter



Change user password.
(Present only when a standard user is logged in.)



Log current user out and return to User Login Mode.



Activate security features.

Present only when security is available but not active.



Enter Administration Mode.

Option present only when Administrator is logged in.

Note: If activating security features, the user will be prompted for a "Y" (yes) or "N" (no) to confirm the menu choice, at which point the user will be asked for a username and password before continuing. Only the administrator can activate the security features.

Save OSD window parameters for the port



Return to Command Mode



Help Mode

To enter Help Mode press the <F1> key from the Command Mode menu (see page 14).

Help Mode displays a list of commands with a short explanation of their function. These lists are organized in pages for each mode (i.e. COMMAND, EDIT, and SEARCH). The following options enable the user to quickly obtain information on any command.

Function:

Keystroke:

View the previous page of help if available



View the next page of help if available



Exit HELP and return to previous mode



KEYBOARD FEATURES

The keyboard configuration of each CPU is saved in the USB Wizard. For example, if the CPU attached to Port 2 had CAPS LOCK and NUM LOCK selected the last time that CPU was accessed, then they will automatically be set when that CPU is accessed again.

Keyboard-To-Computer Translation (See Fig. 19 on page 19 for reference.)

The USB Wizard enables a mixture of otherwise incompatible peripheral computer components to be connected together. This is accomplished by performing keyboard-to-computer translations automatically (i.e. translate a MAC keyboard and mouse to a Windows type CPU). The chart below shows the capabilities of devices controlling certain CPU types.

Translation Capabilities

<i>Device</i>	CPU		
	<i>Sun</i>	<i>Mac</i>	<i>Windows</i>
Sun Keyboard	Full functionality	Full functionality	Full functionality
AT101 Keyboard	Extra keys emulation	Power key emulation	Full functionality
Mac keyboard	Extra keys emulation	Full functionality	Full functionality-except Application Key
Apple Pro Keyboard	Extra keys emulation	Extra Keys not supported (Eject, Mute, Volume+, Volume-)	Full functionality
Sun Mouse	Full functionality	Full functionality	Full functionality
Wheel Mouse	Full functionality	Full functionality	Full functionality
Apple Mouse	Right button emulation	Full functionality	Right button emulation

Translation Tables

Use the charts below to type SUN's additional keys with Win95 and Apple keyboards:

SUN Extra Keys

WINxx or Mac Keyboards	Sun Extra Keys
Space Bar + F1	Stop
Space Bar + F2	Again
Space Bar + F3	Props
Space Bar + F4	Undo
Space Bar + F5	Front
Space Bar + F6	Copy
Space Bar + F7	Open
Space Bar + F8	Paste
Space Bar + F9	Find
Space Bar + F10	Cut
Space Bar + F11	Help
Space Bar + F12	Compose
Space Bar + Up Arrow	Volume +
Space Bar + Down Arrow	Volume -
Space Bar + Left Arrow	Mute

Power Key Emulation

Win95 Keyboards	Mac CPU	Sun CPU
SB+RT Arrow	Power	Power

Mouse Click Equivalents

To emulate right-button click using an Apple 1-button mouse, hold down the CMND key (key with open apple insignia) while pressing the mouse button.

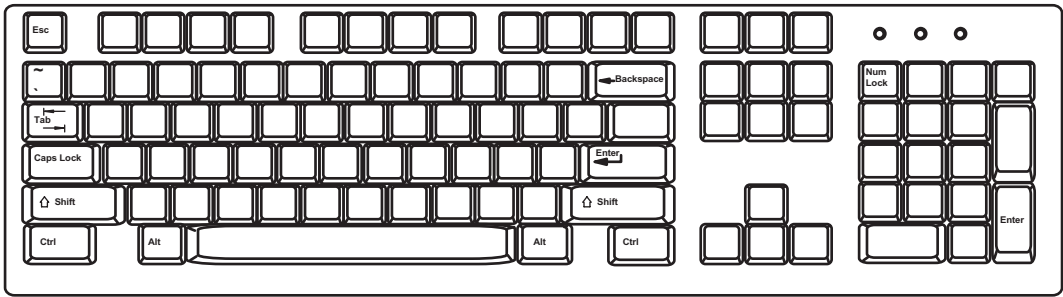

Typical 101 Keyboard

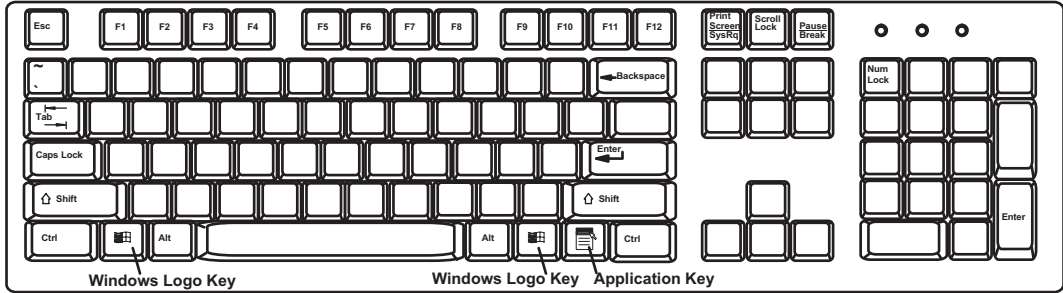

Windows USB Keyboard

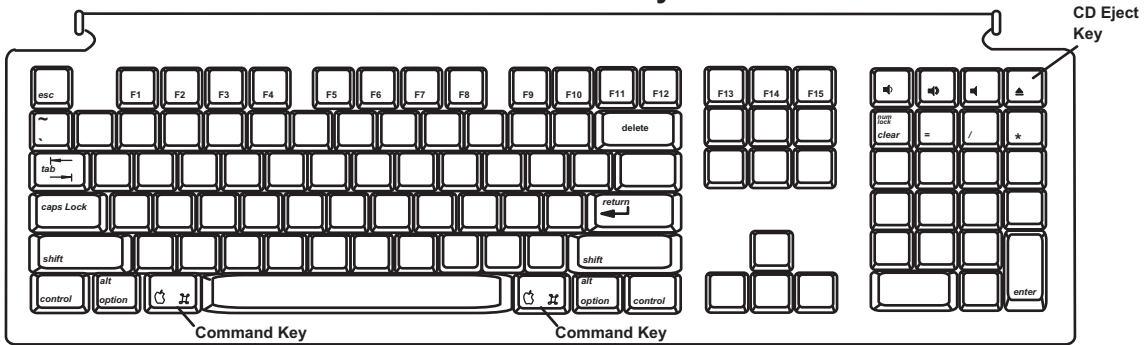

Apple Pro USB Keyboard



SUN USB Keyboard

Figure 19- Keyboard Layouts

HOW TO DISABLE OPERATING MODES

Two operating modes of the USB Wizard can be disabled if desired. The Command Mode can be disabled which would also disable the Scan Mode, or, the Scan Mode can be separately disabled leaving Command Mode enabled.

To disable these operating modes, the user must get access to the jumpers block. This block is located close to the dip switches on the circuit board the keyboards plug into (called the digital board) inside the USB Wizard. (See Fig. 20)

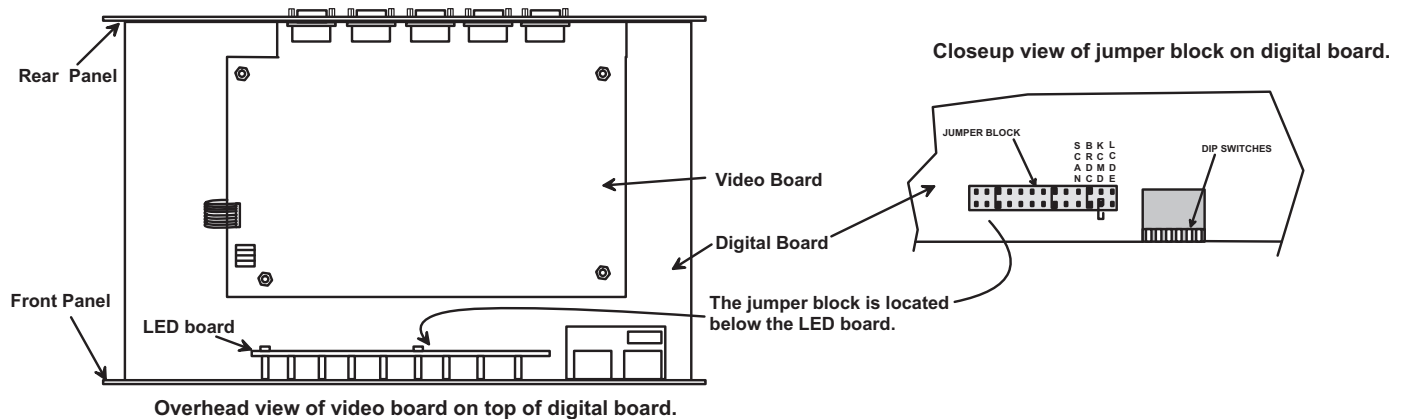

Figure 20- Location of the jumpers block

If the unit is a rackmount style, the digital board is located directly beneath the cover of the unit, requiring the user to only remove the 9 screws from the cover to get access. With the cover removed, the jumpers block will be easy to locate (see Fig. 20). Follow the instructions under "CONFIGURING THE JUMPER BLOCK" (page 21) to disable the desired mode(s).

If the unit is in a plastic case, the digital board is located on the bottom of the case, requiring the user to partially disassemble the unit to gain access to the jumpers block.

For models in a plastic case::

1. The USB Wizard must be completely disconnected from all computer components.
2. Unplug the USB Wizard from the electrical outlet.
3. Remove the two philips-head screws from the underside of the USB Wizard and set the USB Wizard on a firm and flat surface, bottom down (see Fig. 21).

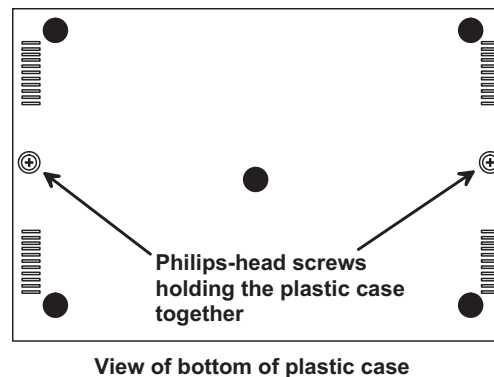

Figure 21- Remove the philips-head screws

4. Remove the top half of the plastic case from the USB Wizard.

Note: Before proceeding, it is important to discharge any static charge by touching any large metal object (away from the USB Wizard).

- Grasp firmly the front panel and slide the front panel up out of the slots in the plastic case that support it. Once the panel is clear of the case, pivot the panel back approximately 1", just enough to expose the jumper block. (See Fig. 22.) Be careful not to dislodge the connection of the ribbon connecting the LED board to the digital board. If it appears to become loose, be sure to reseat the connection before re-assembly. Now follow the instructions under "CONFIGURING THE JUMPER BLOCK" below.

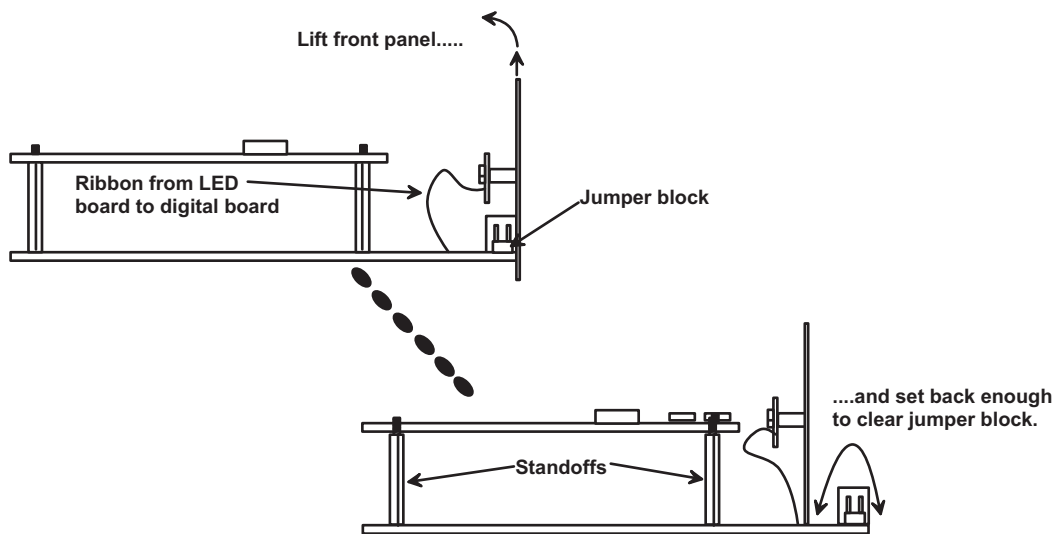

Figure 22- Get access to jumper block

Configuring The Jumper Block

Once the jumper block is exposed, apply a jumper across the appropriate pins to disable the desired mode(s) according to the chart below.

Pin Designation	Mode
KCMD	Command Mode*
SCAN	Scan Mode

*Note: Putting a jumper across pins KCMD to disable Command Mode will also disable Scan Mode.

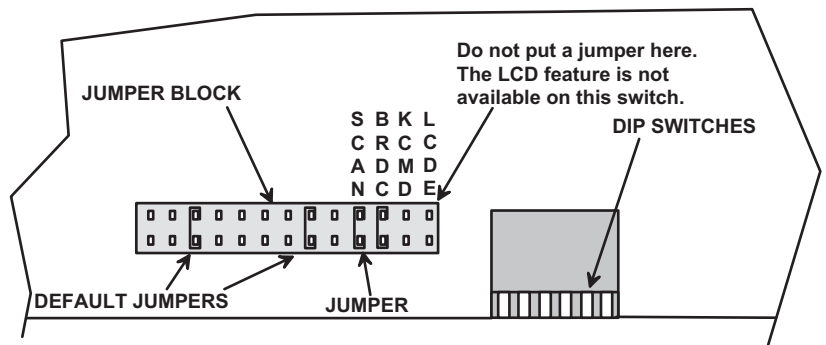

Drawing shows jumper across SCAN pins, disabling Scan Mode. Command Mode is still enabled.

Figure 23- Configure the jumper block

Once the desired jumpers are in place, reverse the disassembly process to re-assemble the USB Wizard. Do not turn the power ON until the switch has been properly re-assembled.

TROUBLESHOOTING

PROBLEM: Keyboard Errors

SOLUTION: Check cable connections on each CPU and the switch.

PROBLEM: No Video

SOLUTION: Check cable connections on each CPU and the switch. Verify that keyboard and video connect from each CPU to matching ports. After reconnecting, CPU may need to be re-booted in order to sense the monitor connection.

PROBLEM: No Mouse Movement

SOLUTION: Check cable connections of mouse. Verify that mouse driver was loaded.

SERIAL NO.: _____

DATE: _____

INSPECTED BY: _____

Free Manuals Download Website

<http://myh66.com>

<http://usermanuals.us>

<http://www.somanuals.com>

<http://www.4manuals.cc>

<http://www.manual-lib.com>

<http://www.404manual.com>

<http://www.luxmanual.com>

<http://aubethermostatmanual.com>

Golf course search by state

<http://golfingnear.com>

Email search by domain

<http://emailbydomain.com>

Auto manuals search

<http://auto.somanuals.com>

TV manuals search

<http://tv.somanuals.com>