

Table of Contents

| | |
|---------------------------------|-----------|
| Introduction | 4 |
| Instrument Cluster | 12 |
| Warning lights and chimes | 12 |
| Gauges | 17 |
| Message center | 18 |
| Entertainment Systems | 35 |
| MyLincoln Touch™ system | 35 |
| Climate Controls | 36 |
| Automatic temperature control | 36 |
| Touchscreen features | 39 |
| Rear window defroster | 42 |
| Lights | 44 |
| Headlamps | 44 |
| Turn signal control | 49 |
| Bulb replacement | 51 |
| Driver Controls | 57 |
| Windshield wiper/washer control | 57 |
| Steering wheel adjustment | 59 |
| Power windows | 63 |
| Mirrors | 65 |
| Speed control | 67 |
| Adaptive cruise control | 69 |
| Locks and Security | 91 |
| Locks | 97 |
| Anti-theft system | 112 |

Table of Contents

| | |
|--|------------|
| Seating and Safety Restraints | 116 |
| Seating | 116 |
| Safety restraints | 129 |
| Airbags | 143 |
| Child restraints | 158 |
| Tires, Wheels and Loading | 176 |
| Tire information | 178 |
| Tire inflation | 180 |
| Tire Pressure Monitoring System (TPMS) | 193 |
| Vehicle loading | 198 |
| Trailer towing | 205 |
| Recreational towing | 209 |
| Driving | 210 |
| Starting | 210 |
| Brakes | 216 |
| AdvanceTrac® | 218 |
| Transmission operation | 226 |
| Reverse sensing system | 230 |
| Rear-view camera system | 232 |
| Roadside Emergencies | 254 |
| Getting roadside assistance | 254 |
| Hazard flasher control | 255 |
| Fuel pump shut-off | 255 |
| Fuses and relays | 256 |
| Changing tires | 265 |
| Wheel lug nut torque | 271 |
| Jump starting | 272 |
| Wrecker towing | 276 |
| Customer Assistance | 278 |
| Reporting safety defects (U.S. only) | 285 |
| Reporting safety defects (Canada only) | 285 |
| Cleaning | 286 |

Table of Contents

| | |
|---|------------|
| Maintenance and Specifications | 294 |
| Engine compartment | 296 |
| Engine oil | 298 |
| Battery | 301 |
| Engine coolant | 304 |
| Fuel information | 309 |
| Air filter(s) | 324 |
| Part numbers | 328 |
| Maintenance product specifications and capacities | 329 |
| Engine data | 332 |
| Accessories | 335 |
| Ford Extended Service Plan | 337 |
| Scheduled Maintenance Guide | 341 |
| Normal scheduled maintenance and log | 347 |
| Index | 361 |

All rights reserved. Reproduction by any means, electronic or mechanical including photocopying, recording or by any information storage and retrieval system or translation in whole or part is not permitted without written authorization from Ford Motor Company. Ford may change the contents without notice and without incurring obligation.

Copyright © 2010 Ford Motor Company

Introduction

CONGRATULATIONS

Congratulations on acquiring your new Lincoln. Please take the time to get well acquainted with your vehicle by reading this handbook. The more you know and understand about your vehicle, the greater the safety and pleasure you will derive from driving it.

For more information on Ford Motor Company and its products visit the following website:

- In the United States: www.ford.com
- In Canada: www.ford.ca
- In Mexico: www.ford.com.mx
- In Australia: www.ford.com.au

Additional owner information is given in separate publications.

This Owner's Guide describes every option and model variant available and therefore some of the items covered may not apply to your particular vehicle. Furthermore, due to printing cycles it may describe options before they are generally available.

Remember to pass on the Owner's Guide when reselling the vehicle. It is an integral part of the vehicle.

SAFETY AND ENVIRONMENT PROTECTION



Warning symbols in this guide

How can you reduce the risk of personal injury to yourself or others? In this guide, answers to such questions are contained in comments highlighted by the warning triangle symbol. These comments should be read and observed.



Warning symbols on your vehicle

When you see this symbol, it is imperative that you consult the relevant section of this guide before touching or attempting adjustment of any kind.



Introduction

Protecting the environment

We must all play our part in protecting the environment. Correct vehicle usage and the authorized disposal of waste, cleaning and lubrication materials are significant steps towards this aim. Information in this respect is highlighted in this guide with the tree symbol.



CALIFORNIA Proposition 65 Warning



WARNING: Engine exhaust, some of its constituents, and certain vehicle components contain or emit chemicals known to the State of California to cause cancer and birth defects or other reproductive harm. In addition, certain fluids contained in vehicles and certain products of component wear contain or emit chemicals known to the State of California to cause cancer and birth defects or other reproductive harm.

PERCHLORATE MATERIAL

Certain components of this vehicle such as airbag modules, seat belt pretensioners, and button cell batteries may contain Perchlorate Material – Special handling may apply for service or vehicle end of life disposal. See www.dtsc.ca.gov/hazardouswaste/perchlorate.

BREAKING-IN YOUR VEHICLE

Your vehicle does not need an extensive break-in. Try not to drive continuously at the same speed for the first 1,000 miles (1,600 km) of new vehicle operation. Vary your speed frequently in order to give the moving parts a chance to break in.

Drive your new vehicle at least 1,000 miles (1,600 km) before towing a trailer. For more detailed information about towing a trailer, refer to *Trailer towing* in the *Tires, Wheels and Loading* chapter.

Do not add friction modifier compounds or special break-in oils since these additives may prevent piston ring seating. See *Engine oil* in the *Maintenance and Specifications* chapter for more information on oil usage.

SPECIAL NOTICES

New Vehicle Limited Warranty

For a detailed description of what is covered and what is not covered by your vehicle's New Vehicle Limited Warranty, refer to the *Warranty Guide* that is provided to you along with your Owner's Guide.

Introduction

Special instructions

For your added safety, your vehicle is fitted with sophisticated electronic controls.



WARNING: Please read the section *Airbag Supplemental Restraint System (SRS)* in the *Seating and Safety Restraints* chapter. Failure to follow the specific warnings and instructions could result in personal injury.



WARNING: Front seat mounted rear-facing child or infant seats should **NEVER** be placed in front of an active passenger airbag.

IMPORTANT INFORMATION FOR P265/40R22 LOW-PROFILE TIRES AND WHEELS

If your vehicle is equipped with P265/40R22 tires, they are low-profile tires. These tires and wheels are designed to give your vehicle a sport appearance. With low-profile tires, you may notice an increase in road noise and faster tire wear, depending on road conditions and driving styles. Due to their design, low-profile tires and wheels are more prone to road damage from potholes, rough or unpaved roads, car wash rails and curb contact than standard tires and wheels. Your vehicle's warranty does not cover these types of damage. Tires should always be kept at the correct inflation pressures and extra caution should be taken when operating on rough roads to avoid impacts that could cause wheel and tire damage.

DATA RECORDING

Service Data Recording

Service data recorders in your vehicle are capable of collecting and storing diagnostic information about your vehicle. This potentially includes information about the performance or status of various systems and modules in the vehicle, such as engine, throttle, steering or brake systems. In order to properly diagnose and service your vehicle, Ford Motor Company, Ford of Canada, and service and repair facilities may access or share among them vehicle diagnostic information received through a direct connection to your vehicle when diagnosing or servicing your vehicle. For U.S. only (if equipped), if you choose to use the SYNC® Vehicle Health Report, you consent that certain diagnostic information may also be accessed electronically by Ford Motor Company and Ford

6

Introduction

authorized service facilities, and that the diagnostic information may be used for any purpose. See your *SYNC*[®] supplement for more information.

Event Data Recording

This vehicle is equipped with an event data recorder (EDR). The main purpose of an EDR is to record, in certain crash or near crash-like situations, such as an airbag deployment or hitting a road obstacle; this data will assist in understanding how a vehicle's systems performed. The EDR is designed to record data related to vehicle dynamics and safety systems for a short period of time, typically 30 seconds or less. The EDR in this vehicle is designed to record such data as:

- How various systems in your vehicle were operating;
- Whether or not the driver and passenger seatbelts were buckled/fastened;
- How far (if at all) the driver was depressing the accelerator and/or the brake pedal; and
- How fast the vehicle was travelling; and
- Where the driver was positioning the steering wheel.

This data can help provide a better understanding of the circumstances in which crashes and injuries occur.

Note: EDR data is recorded by your vehicle only if a non-trivial crash situation occurs; no data is recorded by the EDR under normal driving conditions and no personal data or information (e.g., name, gender, age, and crash location) is recorded (see limitations regarding 911 Assist and Traffic, directions and Information privacy below). However, parties, such as law enforcement, could combine the EDR data with the type of personally identifying data routinely acquired during a crash investigation.

Introduction

To read data recorded by an EDR, special equipment is required, and access to the vehicle or the EDR is needed. In addition to the vehicle manufacturer, other parties, such as law enforcement, that have such special equipment, can read the information if they have access to the vehicle or the EDR. Ford Motor Company and Ford of Canada do not access event data recorder information without obtaining consent, unless pursuant to court order or where required by law enforcement, other government authorities or other third parties acting with lawful authority. Other parties may seek to access the information independently of Ford Motor Company and Ford of Canada.

Note: Including to the extent that any law pertaining to Event Data Recorders applies to SYNC® or its features, please note the following: Once 911 Assist (if equipped) is enabled (set ON), 911 Assist may, through any paired and connected cell phone, disclose to emergency services that the vehicle has been in a crash involving the deployment of an airbag or, in certain vehicles, the activation of the fuel pump shut-off. Certain versions or updates to 911 Assist may also be capable of being used to electronically or verbally provide to 911 operators the vehicle location (such as latitude and longitude), and/or other details about the vehicle or crash or personal information about the occupants to assist 911 operators to provide the most appropriate emergency services. If you do not want to disclose this information, do not activate the 911 Assist feature. See your SYNC® supplement for more information.

Additionally, when you connect to Traffic, Directions and Information (if equipped, U.S. only) the service uses GPS technology and advanced vehicle sensors to collect the vehicle's current location, travel direction, and speed ("vehicle travel information") only to help provide you with the directions, traffic reports, or business searches your request. If you do not want Ford or its vendors to receive this information, do not activate the service. Ford Motor Company and the vendors it uses to provide you with this information do not store your vehicle travel information. For more information, see Traffic, Directions and Information, Terms and Conditions. See your SYNC® supplement for more information.

Introduction

CELL PHONE USE

The use of Mobile Communications Equipment has become increasingly important in the conduct of business and personal affairs. However, drivers must not compromise their own or others' safety when using such equipment. Mobile Communications can enhance personal safety and security when appropriately used, particularly in emergency situations. Safety must be paramount when using mobile communications equipment to avoid negating these benefits.

Mobile Communication Equipment includes, but is not limited to, cellular phones, pagers, portable email devices, text messaging devices and portable two-way radios.



WARNING: Driving while distracted can result in loss of vehicle control, accident and injury. Ford strongly recommends that you use extreme caution when using any device or feature that may take your focus off the road. Your primary responsibility is the safe operation of your vehicle.

We recommend against the use of any handheld device while driving and that you comply with all applicable laws.







EXPORT UNIQUE (NON-UNITED STATES/CANADA) VEHICLE SPECIFIC INFORMATION

For your particular global region, your vehicle may be equipped with features and options that are different from the features and options that are described in this Owner's Guide. A market unique supplement may be supplied that complements this book. By referring to the market unique supplement, if provided, you can properly identify those features, recommendations and specifications that are unique to your vehicle. This Owner's Guide is written primarily for the U.S. and Canadian Markets. Features or equipment listed as standard may be different on units built for Export. **Refer to this Owner's Guide for all other required information and warnings.**

Introduction















These are some of the symbols you may see on your vehicle.

Vehicle Symbol Glossary

| | | | |
|-----------------------------------|---|----------------------------|---|
| Safety Alert |  | See Owner's Guide |  |
| Fasten Safety Belt |  | Airbag - Front |  |
| Airbag - Side |  | Child Seat Lower Anchor |  |
| Child Seat Tether Anchor |  | Brake System |  |
| Anti-Lock Brake System |  | Parking Brake System |  |
| Brake Fluid - Non-Petroleum Based |  | Parking Aid System |  |
| Stability Control System |  | Speed Control |  |
| Master Lighting Switch |  | Hazard Warning Flasher |  |
| Fog Lamps-Front |  | Fuse Compartment |  |
| Fuel Pump Reset |  | Windshield Wash/Wipe |  |
| Windshield Defrost/Demist |  | Rear Window Defrost/Demist |  |

Introduction

Vehicle Symbol Glossary

| | | | |
|-------------------------------------|---|---|---|
| Power Windows Front/Rear |  | Power Window Lockout |  |
| Child Safety Door Lock/Unlock |  | Interior Luggage Compartment Release |  |
| Panic Alarm |  | Engine Oil |  |
| Engine Coolant |  | Engine Coolant Temperature |  |
| Do Not Open When Hot |  | Battery |  |
| Avoid Smoking, Flames, or Sparks |  | Battery Acid |  |
| Explosive Gas |  | Fan Warning |  |
| Power Steering Fluid |  | Maintain Correct Fluid Level |  |
| Service Engine Soon |  | Engine Air Filter |  |
| Passenger Compartment Air Filter |  | Jack |  |
| Check Fuel Cap |  | Low Tire Pressure Warning |  |

Instrument Cluster

WARNING LIGHTS AND CHIMES

Instrument cluster with standard measure shown; metric similar

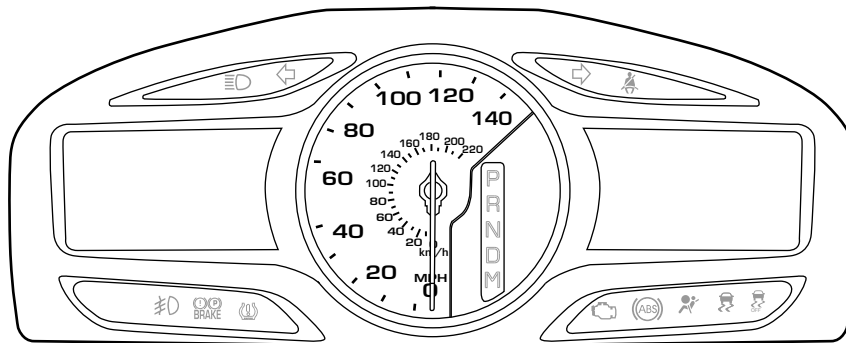

Warning lights can alert you to a vehicle condition that may become serious enough to cause extensive repairs. A warning light may illuminate when a problem exists with one of your vehicle's functions. Many lights will illuminate when you start your vehicle to make sure the bulbs work. If any light remains on after starting the vehicle, refer to the respective system warning light for additional information.

Note: Some warning lights are reconfigurable telltale (RTT) indicators. These indicators display in the message center and function the same as a warning light but do not display on startup.

Service engine soon: The service engine soon indicator light illuminates when the ignition is first turned on to check the bulb and to indicate whether the vehicle is ready for Inspection/Maintenance (I/M) testing. Normally, the service engine soon light will stay on until the engine is cranked, then turn itself off if no malfunctions are present. However, if after 15 seconds the service engine soon light blinks eight times, it means that the vehicle is not ready for I/M testing. See the *Readiness for Inspection/Maintenance (I/M) testing* in the *Maintenance and Specifications* chapter.

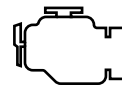

Instrument Cluster

Solid illumination after the engine is started indicates the on-board diagnostics system (OBD-II) has detected a malfunction. Refer to *On-board diagnostics (OBD-II)* in the *Maintenance and Specifications* chapter. If the light is blinking, engine misfire is occurring which could damage your catalytic converter. Drive in a moderate fashion (avoid heavy acceleration and deceleration) and contact your authorized dealer as soon as possible.



WARNING: Under engine misfire conditions, excessive exhaust temperatures could damage the catalytic converter, the fuel system, interior floor coverings or other vehicle components, possibly causing a fire.

Powertrain malfunction/reduced power (RTT):

Illuminates when a powertrain or an AWD fault has been detected. Contact your authorized dealer as soon as possible.



Brake system warning light: To confirm the brake system warning light is functional, it will momentarily illuminate when the ignition is turned to on when the



engine is not running, or in a position between on and start, or by applying the parking brake when the ignition is turned to on. If the brake system warning light does not illuminate at this time, contact your authorized dealer as soon as possible. Illumination after releasing the parking brake indicates low brake fluid level or a brake system malfunction. Contact your authorized dealer as soon as possible.



WARNING: Driving a vehicle with the brake system warning light on is dangerous. A significant decrease in braking performance may occur. It will take you longer to stop the vehicle. Contact your authorized dealer as soon as possible. Driving extended distances with the parking brake engaged can cause brake failure and the risk of personal injury.

Instrument Cluster

Anti-lock brake system: If the ABS light stays illuminated or continues to flash, a malfunction has been detected. Contact your authorized dealer as soon as possible. Normal braking is still functional unless the brake warning light also is illuminated.

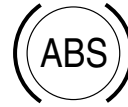

Airbag readiness: If this light fails to illuminate when the ignition is turned on, continues to flash or remains on, contact your authorized dealer as soon as possible. A chime will sound when there is a malfunction in the indicator light.



Safety belt: Reminds you to fasten your safety belt. A Belt-Minder® chime will also sound to remind you to fasten your safety belt. Refer to the *Seating and Safety Restraints* chapter to activate/deactivate the Belt-Minder® chime feature.



Charging system (RTT):

Illuminates when the battery is not charging properly. If it stays on while the engine is running, there may be a malfunction with the charging system. Contact your authorized dealer as soon as possible. This indicates a problem with the electrical system or a related component.



Engine oil pressure (RTT):

Illuminates when the oil pressure falls below the normal range, refer to *Engine oil* in the *Maintenance and Specifications* chapter.



AdvanceTrac® : Displays when the AdvanceTrac®/traction control is active. If the light remains on, have the system serviced immediately, refer to the *Driving* chapter for more information.



Instrument Cluster

AdvanceTrac® off light:

Illuminates when AdvanceTrac®/traction control has been disabled by the driver. Refer to the *Driving* chapter for more information.



Low tire pressure warning:

Illuminates when your tire pressure is low. If the light remains on at start up or while driving, the tire pressure should be checked. Refer to *Inflating your tires* in the *Tires, Wheels and Loading* chapter. When the ignition is first turned to on, the light will illuminate for 3 seconds to ensure the bulb is working. If the light does not turn on or begins to flash, contact your authorized dealer as soon as possible. For more information on this system, refer to *Tire pressure monitoring system (TPMS)* in the *Tires, Wheels and Loading* chapter.

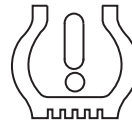

Low fuel (RTT): Illuminates when the fuel level in the fuel tank is at or near empty. Refer to *Fuel gauge* in this chapter.



Speed control (RTT): The speed control system indicator light changes color to indicate what mode the system is in:



- **On (gray light):** Illuminates when the speed control system is turned on. Turns off when the speed control system is engaged or turned off.
- **Engaged (green light):** Illuminates when the speed control system is engaged. Turns off when the speed control system is disengaged.

Adaptive cruise control (RTT) (if equipped): The speed control system indicator light changes color to indicate what mode the system is in:



- **On (gray light):** Illuminates when the adaptive cruise control system is turned on. Turns off when the speed control system is turned off.
- **Engaged (green light):** Illuminates when the adaptive cruise control system is engaged. Turns off when the speed control system is disengaged.

Instrument Cluster

Door ajar (RTT): Displays when the ignition is on and any door is open.



Tailgate ajar (RTT): Displays when the ignition is on and the trunk is open.



Low washer fluid (RTT): Illuminates when the windshield washer fluid is low.



Turn signal: Illuminates when the left or right turn signal or the hazard lights are turned on. If the indicators flash faster, check for a burned out bulb.



High beams: Illuminates when the high beam headlamps are turned on.



Fog lamps: Illuminates when the fog lamps are turned on.



Heads up display (if equipped): A red bar will illuminate on the windshield in certain instances when using adaptive cruise control and/or the collision warning system. It will also illuminate momentarily when you start your vehicle to make sure the display works. See *Using adaptive cruise control* in the *Driving* chapter for more information.

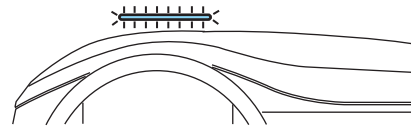

Instrument Cluster

Grade assist (RTT): Illuminates when the grade assist is turned on.



Headlamps on warning chime: Sounds when the headlamps or parking lamps are on, the ignition is off (the key is not in the ignition) and the driver's door is opened.

Parking brake on chime: Sounds when the parking brake is left on and the vehicle is driven. If the warning stays on after the park brake is off, contact your authorized dealer as soon as possible.

GAUGES

Shown in standard measure. Metric similar.

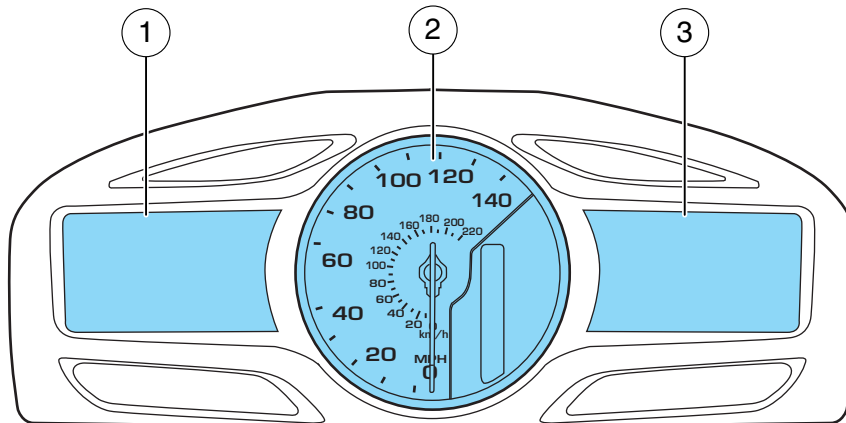

1. **Multifunction display:** This displays the fuel gauge, tachometer, engine coolant temperature and the odometer/trip meter. This is also used to configure different vehicle personalization options and display the status of various vehicle functions. See *Message center* in this chapter for more information.

2. **Speedometer:** Indicates the current vehicle speed.

3. **Infotainment display:** This display is used for the entertainment, phone, navigation and climate systems. See the *MyLincoln Touch*™ supplement for more information.

Instrument Cluster

MESSAGE CENTER

 **WARNING:** Driving while distracted can result in loss of vehicle control, accident and injury. Ford strongly recommends that drivers use extreme caution when using any device or feature that may take their focus off the road. Your primary responsibility is the safe operation of the vehicle. We recommend against the use of any handheld device while driving and that you comply with all applicable laws.

Your vehicle's message center is capable of monitoring many vehicle systems and will alert you to potential vehicle problems and various conditions with informational messages and/or warnings.

The message center is also used to program/configure the different features of your vehicle. The message center display is located in the instrument cluster.

Use the left steering wheel controls to navigate through the message center.

Press the up/down arrow buttons to move up/down through the message center choices.



Press the left/right arrow buttons to move left/right through the message center choices.



Instrument Cluster

Press the OK button to select highlighted options and confirm choices/messages.

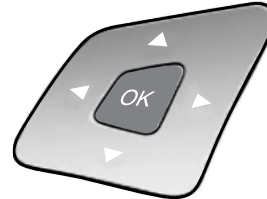

Main menu

From the main menu screen you can choose the following:

- Display Mode
- Trip 1 & 2
- Fuel Economy
- Settings
- Information

Scroll up/down to highlight one of the options, then press the right arrow key or OK to enter into that menu option.

Gauge mode

Press the right arrow on the left steering wheel mounted button when display mode is selected. The boxes in the upper right corner of the screen indicate that there are multiple screens that you can navigate through. Each press of the right arrow will navigate to the next screen until the last screen is reached. The white highlighted box indicates which of the screens you are currently viewing:

Distance to empty (DTE) + Fuel gauge

Shown with vertical bar tachometer enabled



Instrument Cluster

Full analog tachometer + Fuel gauge

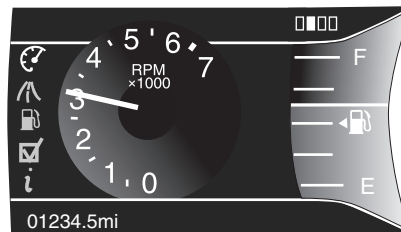

Full analog tachometer + Fuel gauge + Engine coolant temperature gauge



Intelligent all-wheel drive (AWD) (if equipped) + fuel gauge

Shown with vertical bar tachometer enabled

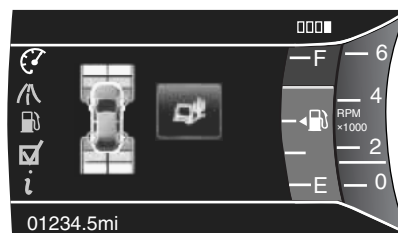

Select-Shift Automatic™ transmission (SST)

Select-Shift transmission allows you to manually shift gears. If your vehicle is equipped with this feature it will be denoted by an M instead of an L located in the shift selector indicator. Refer to *Automatic transmission operation* in the *Driving* chapter.

When SST is activated the M will light up in the shift select indicator and also in the message center.

Instrument Cluster

The selected gear will be displayed at the bottom of the vertical bar tachometer (if selected).

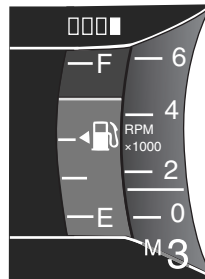

The selected gear will be displayed within the full analog tachometer (if selected).



Trip 1 & 2

Press the right arrow on the left steering wheel mounted button when trip 1 & 2 is selected. The boxes in the upper right corner of the screen indicate that there are multiple screens that you can navigate through. Each press of the right arrow will navigate to the next screen until the last screen is reached. The white highlighted box indicates which of the screens you are currently viewing:

Enhanced trip display

Shown with vertical bar tachometer enabled

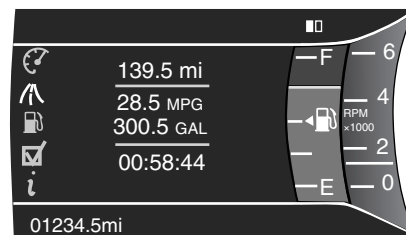

- Trip distance — shows the accumulated trip distance

Instrument Cluster

- Average fuel economy — shows the average fuel economy for a given trip.
- Estimated amount of fuel consumed — shows the amount of fuel used for a given trip.
- Elapsed trip time — timer stops when the vehicle is turned off and restarts when the vehicle is restarted.

Standard trip mode

Shown with vertical bar tachometer enabled

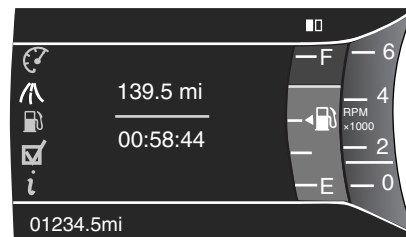

- Trip distance — shows the accumulated trip distance
- Elapsed trip time — timer stops when the vehicle is turned off and restarts when the vehicle is restarted.

Press OK to pause the Trip 1 or 2 screen. Press again to un-pause.

Press and hold OK to reset the currently displayed trip information.

Instrument Cluster

Fuel Economy

Press the right arrow on the left steering wheel mounted button when fuel economy is selected. The boxes in the upper right corner of the screen indicate that there are multiple screens that you can navigate through. Each press of the right arrow will navigate to the next screen until the last screen is reached. The white highlighted box indicates which of the screens you are currently viewing:

Instant fuel economy

Shown with vertical bar tachometer enabled

- This display shows a visual graph of your instantaneous fuel economy. Press the right arrow to reach the other fuel displays and press the left arrow once to return to the previous display.

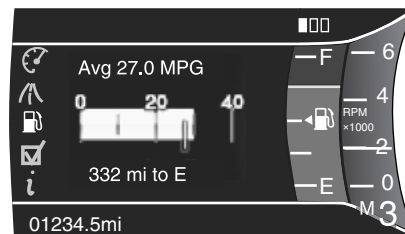

Configurable fuel history

Shown with vertical bar tachometer enabled

- This display shows a bar chart of your fuel history, configurable to 5, 10 or 30 minutes. Refer to Settings to configure the history time.

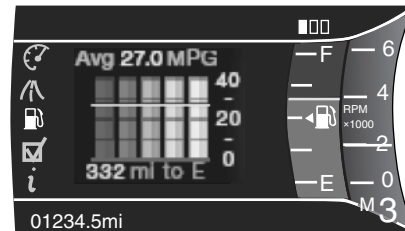

When the fuel level becomes low (50 miles [80 km] to empty), the level indicator will change to amber. When the fuel level becomes critically low (0 miles [0 km] to empty), the level indicator will change to red.

If you calculate your average fuel economy by dividing miles traveled by gallons of fuel used (liters of fuel used by 100 kilometers traveled), your figure may be different than displayed for the following reasons:

- Your vehicle was not perfectly level during fill-up.
- Differences in the automatic shut-off points on the fuel pumps at service stations.
- Variations in top-off procedure from one fill-up to another.
- Rounding of the displayed values to the nearest 0.1 gallon (liter).

Instrument Cluster

To determine your average highway fuel economy, do the following:

1. Drive the vehicle at least 5 miles (8 km) with the speed control system engaged to display a stabilized average.
2. Record the highway fuel economy for future reference.

It is important to press RESET in order to reset the function after setting the speed control to get accurate highway fuel economy readings.

For more information refer to *Essentials of good fuel economy* in the *Maintenance and Specifications* chapter.

Settings

In this mode, you can configure different driver setting choices. Press the right arrow key (when in the Settings menu) to reach the listed modes below:

Note: Some items are optional and may not appear.

| Driver Assist | | |
|---------------------|--|---------------------------------|
| Traction Control | On / Off | |
| Blind Spot | On (default on key cycle) / Off | |
| Collision Warning | Sensitivity (if MyKey™ is programmed) | High / Normal / Low |
| | Chimes | On (default on key cycle) / Off |
| | Warn-<ON> | On (default on key cycle) / Off |
| Cross Traffic Alert | On (default on key cycle) / Off | |
| Cruise Control | Adaptive or Normal | |
| Rear Park Aid | On (default on key cycle) / Off | |
| Trailer Sway | On (default on key cycle) / Off | |

Instrument Cluster

| Vehicle | | | |
|-----------------|--|---------------------------------|----------------------|
| Autolamp Delay | Off, 10 / 20 (default setting) / 30 / 60 / 90 / 120 / 180 seconds | | |
| Easy Entry/Exit | On (default on key cycle) / Off | | |
| Fuel | DTE Calculation | Normal, Towing | |
| | Long Term Econ | Hold OK to Reset... | |
| Locks | Autolock, | On (default on key cycle) / Off | |
| | Autounlock | On (default on key cycle) / Off | |
| | Remote Unlocking | All doors / Driver's door | |
| Menu Control | Standard / Memory On | | |
| Oil Life Reset | Set to 10–100% (100% default setting) | | |
| Power Liftgate | Enable (default setting) / Disable | | |
| Remote Start | Climate Control (using this feature allows you to select different climate control modes when the vehicle is started using the remote start feature) | Heater – A/C | Auto / Last Settings |
| | | Heated Wheel | Auto Heated / Off |
| | | Front Defrost | Auto / Off |
| | | Rear Defrost | Auto / Off |
| | | Driver Seat | Auto / Off |
| | | Passenger Seat | Auto / Off |
| | Duration | 5 / 10 /15 minutes | |
| | Quiet Start | On / Off | |
| | System | Enable / Disable | |
| Windows | Remote Open | On / Off | |
| Wipers | Courtesy Wipe | On / Off | |
| | Rain Sensing | On / Off | |
| | Reverse Wiper | On / Off | |

Instrument Cluster

| *MyKey | |
|------------------|--|
| Create MyKey | Press and hold OK to create MyKey |
| Traction Control | Always On / User Selectable |
| Speed Warning | Off, 65 mph (105 km/h), 55 mph (89 km/h), 45 mph (72 km/h) |
| Max Speed | Set to 80 MPH (130 km/h) / Off |
| Volume Limiter | On / Off |
| Clear MyKeys | Hold OK to Clear MyKeys |

*Some MyKey items will only appear if a MyKey is set.

| Display | |
|---|---------------------------------------|
| Gauge Display | Fuel Gauge / Fuel gauge + Tachometer |
| Trip Display | Standard / Enhanced |
| Language | |
| English / Español / Français | |
| Units | |
| Distance | Miles & Gallons / Kilometers & Liters |
| Temperature | Fahrenheit (°F) / Celsius (°C) |
| Restore defaults | |
| Hold OK to Restore Settings to Factory Defaults | |

Information

In this mode, you can view different vehicle system information and perform a system check.

When “Press OK for info” is displayed, pressing OK will give you information on the currently selected/displayed options. Information is only available when traveling less than 3 mph (5 km/h).

| MyKey |
|---|
| Admin Keys (Number of admin keys) |
| MyKeys (Number of MyKeys programmed) |
| MyKey Miles (km) (Distance traveled using a programmed MyKey) |

Instrument Cluster

| System Check* |
|--------------------------|
| Oil Life |
| Wash Fluid |
| Doors |
| Liftgate |
| B lind spot |
| Cross Traffic |
| Brakes |
| Fuel (distance to empty) |

*Some items will only display during a system check if a problem has been detected. If an issue exists on one of the monitored systems, the message center will display the number of warnings that need immediate attention in red and the number of informational warnings will be listed in amber. Use the up/down arrow buttons to scroll through the list; press the right arrow button to display specific information on the highlighted warning.

System warnings and status messages

System warnings alert you to possible problems or malfunctions in your vehicle's operating systems.

In the event of a multiple warning situation, the message center will cycle the display to show all warnings by displaying each one for four seconds.

The message center will display the last selected feature if there are no more warning messages.

Types of messages and warnings:

- Some messages will appear briefly to inform you of something you may need to take action on or be informed of.
- Some messages will appear once and then again when the vehicle is restarted.
- Some messages will reappear after clearing or being reset if a problem or condition is still present and needs your attention.
- Some messages can be acknowledged and reset by pressing RESET. This allows you to use the full message center functionality by clearing the message.

DRIVER DOOR AJAR — Displayed when the driver door is not completely closed.

Instrument Cluster

LIFTGATE AJAR — Displayed when the liftgate is not completely closed.

PASSENGER DOOR AJAR — Displayed when the passenger door is not completely closed.

REAR LEFT DOOR AJAR — Displayed when the rear left door is not completely closed.

RIGHT REAR DOOR AJAR — Displayed when the rear right door is not completely closed.

CHECK FUEL FILL INLET — Displayed when the fuel fill inlet may not be properly closed. Refer to *Easy Fuel™ “no cap” fuel system* in the *Maintenance and Specifications* chapter.

FUEL LEVEL LOW XXX MI TO E — Displayed as an early reminder of a low fuel condition.

BRAKE FLUID LEVEL LOW — Indicates the brake fluid level is low and the brake system should be inspected immediately. Refer to *Brake fluid* in the *Maintenance and Specifications* chapter.

CHECK BRAKE SYSTEM — Displayed when the brake system needs servicing. If the warning stays on or continues to come on, contact your authorized dealer as soon as possible.

CHECK CHARGING SYSTEM — Displayed when the brake system needs servicing. If the warning stays on or continues to come on, contact your authorized dealer as soon as possible.

PARK BRAKE ENGAGED — Displayed when the parking brake is set, the engine is running and the vehicle is driven more than 3mph (5 km/h). If the warning stays on after the parking brake is released, contact your authorized dealer as soon as possible.

SERVICE ADVANCETRAC — Displayed when the AdvanceTrac® system has detected a condition that requires service. Contact your authorized dealer as soon as possible.

SHIFT TO PARK — Displayed when the start/stop button is pressed to shut off the engine with the shift select lever in any position other than P (Park). Refer to *Fast restart feature* in *Push button start system* in the *Driving* chapter for more information.

CHANGE ENGINE OIL SOON — Displayed when the engine oil life remaining is 10% or less.

ENGINE COOLANT OVER TEMP — Displayed when the engine coolant temperature is excessively high.

LOW ENGINE OIL PRESSURE — Stop the vehicle as soon as safely possible, turn off the engine. Check the oil level. See *Checking the*

28

Instrument Cluster

engine oil in the *Maintenance and Specifications* chapter. If the warning stays on or continues to come on, contact your authorized dealer as soon as possible.

OIL CHANGE REQUIRED — Displayed when the oil life left reaches 0%.

WASHER FLUID LEVEL LOW — Indicates the washer fluid reservoir is less than one quarter full. Check the washer fluid level. Refer to *Windshield washer fluid* in the *Maintenance and Specifications* chapter.

LOW TIRE PRESSURE — Displayed when one or more tires on your vehicle have low tire pressure. Refer to *Inflating Your Tires* in the *Tires, Wheels and Loading* chapter.

TIRE PRESSURE MONITOR FAULT — Displayed when the Tire Pressure Monitoring System is malfunctioning. If the warning stays on or continues to come on, have the system inspected by your authorized dealer.

TIRE PRESSURE SENSOR FAULT — Displayed when a tire pressure sensor is malfunctioning, or your spare tire is in use. For more information on how the system operates under these conditions, refer to *Understanding Your Tire Pressure Monitoring System (TPMS)* in the *Tires, Wheels and Loading* chapter. If the warning stays on or continues to come on, contact your authorized dealer as soon as possible.

POWER STEERING ASSIST FAULT — The power steering system has disabled power steering assist due to a system error; service is required.

CHECK ADAPTIVE HEADLAMPS (if equipped) — Displayed when an error is detected in the adaptive headlamps system.

BUCKLE UP TO UNMUTE AUDIO — Displayed when a MyKey™ is in use and Belt-Minder® is activated. Refer to *MyKey™* in the *Locks and Security* chapter for more information.

REMOVE OBJECTS NEAR PASS SEAT — Displayed when objects are by the passenger seat. After the objects are moved away from the seat, if the warning stays on or continues to come on contact your authorized dealer as soon as possible.

AWD OFF (if equipped) — Displayed when the AWD system has been automatically disabled to protect itself. This is caused by operating the vehicle with the compact spare tire installed or if the system is overheating. The AWD system will resume normal function and clear this

29

Instrument Cluster

message after driving a short distance with the road tire re-installed or after the system is allowed to cool.

CHECK AWD — Displayed in conjunction with the Throttle Control/Transmission/AWD  light when the AWD system is not operating properly. If the warning stays on or continues to come on, contact your authorized dealer as soon as possible.

FOR HILL DESCENT REDUCE SPEED 20 MPH OR LESS (if equipped) — Displayed when hill descent speed exceeds 20 MPH.

FOR HILL DESCENT REDUCE SPEED 32 KM/H OR LESS (if equipped) — Displayed when hill descent speed exceeds 32 KM/H.

FOR HILL DESCENT SHIFT INTO GEAR (if equipped) — Displayed when hill descent control mode requires driver shift transmission into gear.

FOR OFF ROAD SLOW TO 5 MPH (if equipped) — Displayed when the vehicle speed requirement for off road mode entry has not been met.

DRIVER RESUME CONTROL (if equipped) — Displayed when the hill control and off road mode require the driver to resume control.

HILL DESCENT CONTROL ACTIVE (if equipped) — Displayed when hill descent control mode becomes active.

HILL DESCENT CONTROL FAULT (if equipped) — Displayed when a hill descent system fault is present.

HILL DESCENT CONTROL OFF (if equipped) — Displayed when hill descent control mode becomes inactive.

HILL DESCENT CONTROL OFF SYSTEM COOLING (if equipped) — Displayed when hill descent control mode is disabled to cool the brake system.

HILL DESCENT CONTROL READY (if equipped) — Displayed when hill descent control mode is ready.

MODE CHANGE NOT ACCEPTED, RETRY (if equipped) — Displayed when hill descent control mode cannot be changed at time of driver request.

ACCESSORY POWER ACTIVE (if equipped) — Displayed when the vehicle is in the accessory ignition state.

CHECK SPEED DRIVE SAFELY — Displayed when a MyKey™ is in use and the optional setting is on and the vehicle exceeds a preselected speed. Refer to *MyKey™* in the *Locks and Security* chapter for more information.

30

Instrument Cluster

COULD NOT PROGRAM KEY — Displayed when an attempt is made to program a spare key using two existing MyKeys. Refer to *MyKey™* in the *Locks and Security* chapter for more information.

KEY PROGRAMMED 3 KEYS TOTAL — Displayed during spare key programming, when a third Intelligent Access Key is programmed to the system.

KEY PROGRAMMED 4 KEYS TOTAL — Displayed during spare key programming, when a fourth Intelligent Access Key is programmed to the system.

MAX NUMBER OF KEYS PROGRAMMED — Displayed during spare key programming when the maximum number of keys have been programmed.

MYKEY ACTIVE DRIVE SAFELY — Displayed when MyKey™ is active.

MYKEY NOT CREATED — Displayed during key programming when MyKey™ cannot be programmed.

NO KEY DETECTED (if equipped) — Displayed if the Intelligent Access Key is not detected by the system in the following three scenarios:

- When the start/stop button is pressed in an attempt to either start the engine or cycle through the ignition states.
- When the engine is running and a door is opened then closed.
- When the vehicle's speed exceeds 10 mph (16 km/h) for the first time after starting. Refer to *Push button start system* in the *Driving* chapter for more information.

PRESS BRAKE TO START (if equipped) — Displayed when the start/stop button is pressed without the brake pedal being applied. This is a reminder that the brake pedal must be applied when the start/stop button is pressed in order to start the engine.

RESTART NOW OR KEY IS NEEDED (if equipped) — Displayed when the start/stop button is pressed to shut off the engine and a Intelligent Access Key is not detected inside the vehicle. Refer to *Push button start system* in the *Driving* chapter for more information.

SPEED LIMITED TO 130 KM/H — Displayed when starting the vehicle and MyKey™ is in use and the MyKey speed limit is on. Refer to *MyKey™* in the *Locks and Security* chapter for more information.

SPEED LIMITED TO 80 MPH — Displayed when starting the vehicle and MyKey™ is in use and the MyKey speed limit is on. Refer to *MyKey™* in the *Locks and Security* chapter for more information.

Instrument Cluster

STARTING SYSTEM FAULT — This message is displayed when there is a problem with your vehicle's starting security system; your vehicle will not be able to start. See your authorized dealer for service.

VEHICLE AT TOP SPEED OF MYKEY SETTING — Displayed when a MyKey™ is in use and the MyKey speed limit is on and the vehicle speed is 80 mph (130 km/h). Refer to *MyKey™* in the *Locks and Security* chapter for more information.

VEHICLE NEAR MYKEY TOP SPEED — Displayed when a MyKey™ is in use and the MyKey speed limit is on and the vehicle speed is approaching 80 mph (130 km/h). Refer to *MyKey™* in the *Locks and Security* chapter for more information.

WAIT XZ MINUTES — Displays time required before security access is granted to program keys.

CRUISE CONTROL AUTOMATIC BRAKING TURNED OFF (if equipped) — Displayed when adaptive cruise control automatic braking is turned off.

ADAPTIVE CRUISE MALFUNCTION (if equipped) — Displayed when a radar malfunction is preventing the ACC from engaging.

ADAPTIVE CRUISE NOT AVAILABLE (if equipped) — Displayed when conditions exist such that the adaptive cruise cannot function properly.

ADAPTIVE CRUISE NOT AVAILABLE SENSOR BLOCKED SEE MANUAL (if equipped) — Displayed when the radar is blocked because of poor radar visibility due to bad weather or ice/mud/water in front of radar. Driver can typically clean the sensor to resolve.

FRONT SENSOR NOT ALIGNED (if equipped) — Displayed when the adaptive cruise system detects the front sensor is not aligned correctly. See your authorized dealer for service.

COLLISION WARN NOT AVAILABLE (if equipped) — Displayed when there is a system malfunction with the collision warning system. The system will be disabled.

COLLISION WARNING NOT AVAILABLE SENSOR BLOCKED SEE MANUAL (if equipped) — Displayed when the collision warning system radar is blocked because of poor radar visibility due to bad weather or ice/mud/water in front of the radar. Driver can typically clean the sensor to resolve.

COLLISION WARNING MALFUNCTION (if equipped) — Displayed when there is a system malfunction with the collision warning system. The system will be disabled.

32

Instrument Cluster

BLINDSPOT NOT AVAILABLE SENSOR BLOCKED SEE MANUAL(if equipped) — Displayed when the blind spot information system/cross traffic alert system sensors are blocked. See *Blind Spot Information System (BLIS®) with Cross Traffic Alert* in the *Driving* chapter.

BLIND SPOT SYSTEM FAULT (if equipped) — Displayed when a fault with the blind spot information system has occurred. Contact your authorized dealer as soon as possible.

CROSS TRAFFIC NOT AVAILABLE SENSOR BLOCKED SEE MANUAL (if equipped) — Displayed when the blind spot information system/cross traffic alert system sensors are blocked. See *Blind Spot Information System (BLIS®) with Cross Traffic Alert* in the *Driving* chapter.

CROSS TRAFFIC SYSTEM FAULT (if equipped) — Displayed when a fault with the cross traffic alert system has occurred. Contact your authorized dealer as soon as possible.

CROSS TRAFFIC VEHICLE COMING FROM LEFT (if equipped) — Displayed when the blind spot information system with cross traffic alert (CTA) system is operating and senses a vehicle. See *Blind Spot Information System (BLIS®) with Cross Traffic Alert* in the *Driving* chapter.

CROSS TRAFFIC VEHICLE COMING FROM RIGHT (if equipped) — Displayed when the blind spot information system with cross traffic alert (CTA) system is operating and senses a vehicle. See *Blind Spot Information System (BLIS®) with Cross Traffic Alert* in the *Driving* chapter.

ACTIVE PARK FAULT (if equipped) — Displayed when a fault has occurred with the active park assist system. Refer to *Active park assist* in the *Driving* chapter for more information.

CHECK FRONT PARK AID (if equipped) — Displayed when the front park aid is disabled and may need service.

CHECK PARK AID (if equipped) — Displayed when the transmission is in R (Reverse) and the park aid is disabled.

CHECK REAR PARK AID (if equipped) — Displayed when the transmission is in R (Reverse) and the park aid is disabled.

FRONT PARK AID ON OFF (if equipped) — Displays the front park aid status.

REAR PARK AID ON OFF (if equipped) — Displays the rear park aid status.

Instrument Cluster

TO STOP ALARM START VEHICLE — Displayed when the perimeter alarm system is armed and the vehicle is entered using the key on the driver's side door. In order to prevent the perimeter alarm system from triggering, the ignition must be turned to start or on before the 12 second chime expires. See *Perimeter alarm system* in the *Locks and security* chapter.

TRAILER SWAY REDUCE SPEED (if equipped)— Displayed when the trailer sway control has detected trailer sway. For more information, refer to the *Driving* chapter for more information.

TRANSPORT MODE CONTACT DEALER — Contact your authorized dealer as soon as possible.

Entertainment Systems

MYLINCOLN TOUCH™

 **WARNING:** Driving while distracted can result in loss of vehicle control, accident and injury. Ford strongly recommends that drivers use extreme caution when using any device or feature that may take their focus off the road. Your primary responsibility is the safe operation of the vehicle. We recommend against the use of any handheld device while driving and that you comply with all applicable laws.



This system utilizes a four corner strategy and dynamic menu listings to provide quick access to vehicle features and settings.

For more information on this system, please refer to your *MyFord Touch™* / *MyLincoln Touch™ Supplement*.

Climate Controls

DUAL AUTOMATIC TEMPERATURE CONTROL (DATC) SYSTEM WITH MYTEMP

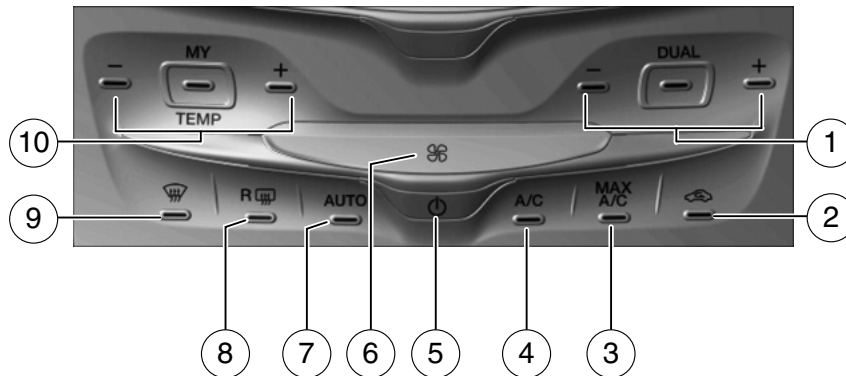

Note: Your climate control system is touch sensitive. You need only lightly touch the control graphic to activate the feature.

Note: Your vehicle is also equipped with touchscreen climate control features. To access, press the lower right corner of the touchscreen. Refer to *Touchscreen features* later in this section for more information.

Temperature conversion: To access the temperature setting, press Menu on the touchscreen. Then press Settings > System > Temperature. Select to view the temperature in either Fahrenheit and Celsius.

1. **Passenger temperature control:** Touch to activate dual zone temperature and to increase (+) or decrease (-) the temperature on the passenger side of the vehicle.

DUAL: Touch to activate dual zone (separate passenger temperature control). Touch again to deactivate and return to single zone temperature control (where the driver settings control the temperature for the entire vehicle).



2. **Recirculated air:** Touch to activate/deactivate air recirculation in the vehicle. Recirculated air may reduce the amount of time needed to cool down the interior of the vehicle and may also help reduce undesired odors from reaching the interior of the vehicle. Recirculated air engages automatically when MAX A/C is selected or can be engaged manually in any airflow mode except (defrost). Recirculated air may turn off automatically in all airflow modes except MAX A/C to reduce fog potential.

3. **MAX A/C:** Distributes recirculated air through the instrument panel vents to cool the vehicle. This re-cooling of the interior air is more

36

Climate Controls

economical and efficient. Recirculated air may also help reduce undesirable odors from entering the vehicle. Touch MAX A/C again for normal A/C operation.

4. **A/C control:** Touch to activate/deactivate air conditioning. Use with recirculated air to improve cooling performance and efficiency. Engages automatically in MAX A/C,  (defrost) and  (floor/defrost).

5.  **(Power):** Touch to activate/deactivate the climate control system. When the system is off, outside air is prevented from entering the vehicle through the vents.

6.  **(Fan speed):** Slide your finger over the fan bar to increase or decrease the fan speed.

7. **AUTO:** Touch to engage full automatic operation. Select the desired temperature using the temperature control. The system will automatically determine fan speed, airflow distribution, A/C on or off, and outside or recirculated air, to heat or cool the vehicle in order to reach the desired temperature.

8.  **(Rear defroster):** Touch to activate/deactivate the rear defroster. This button will also activate/deactivate the heated mirrors (if equipped). Refer to *Rear window defroster* later in this chapter for more information.

9.  **(Defrost):** Distributes outside air through the windshield defroster vents and demister vents. Can be used to clear the windshield of fog and thin ice. The system will automatically provide outside air to reduce window fogging. Touch this button again to return to the previous air flow selection. To return to full automatic control, touch AUTO.

10. **Driver temperature control:** Touch to increase (+) or decrease (-) the temperature on the driver side of the vehicle. If the passenger temperature controls are not activated (dual zone), the driver's settings will determine the temperature setting for the entire vehicle cabin.



MyTemp: Touch and hold to save the desired temperature for MyTemp. To access this setting again, simply touch the indicator.

The MyTemp feature can be used to store and recall a preset driver's temperature. This feature is provided so this temperature can be quickly adjusted to a frequently used setting with a single button touch.



To save a new preset temperature for the active user, manually adjust the driver's temperature to the desired value then touch and hold the MyTemp button for at least two seconds. Any subsequent touch of the MyTemp button will automatically change to this set temperature for this user.

Climate Controls

Operating tips

- To reduce fog build-up on the windshield during humid weather, select  (defrost) or  (floor/defrost).
- To reduce humidity build-up inside the vehicle, do not drive with the system off or with  (recirculated air) engaged and A/C off.
- Do not put objects under the front seats that will interfere with the airflow to the back seats.
- Remove any snow, ice or leaves from the air intake area at the base of the windshield.
- To improve the A/C cool down, drive with the windows slightly open for 2-3 minutes after start-up or until the vehicle has been “aired out.”
- A small amount of air may be felt from the floor vent regardless of the air distribution setting that is selected.

For maximum cooling performance (MAX A/C):

1. Press MAX A/C. The system will default to single-zone operation and set the temperature to 60°F (16°C).
2. A/C,  and  will be selected.
3. Fan speed will be increased to the highest speed, but can be adjusted as desired.

To aid in side window defogging/demisting in cold weather:

1. Select  (panel/floor).
2. Select A/C.
3. Adjust the temperature control to maintain comfort.
4. Set the fan speed to the highest setting.
5. Direct the outer instrument panel vents towards the side windows.

To increase airflow to the outer instrument panel vents, close the vents located in the middle of the instrument panel.

Climate Controls

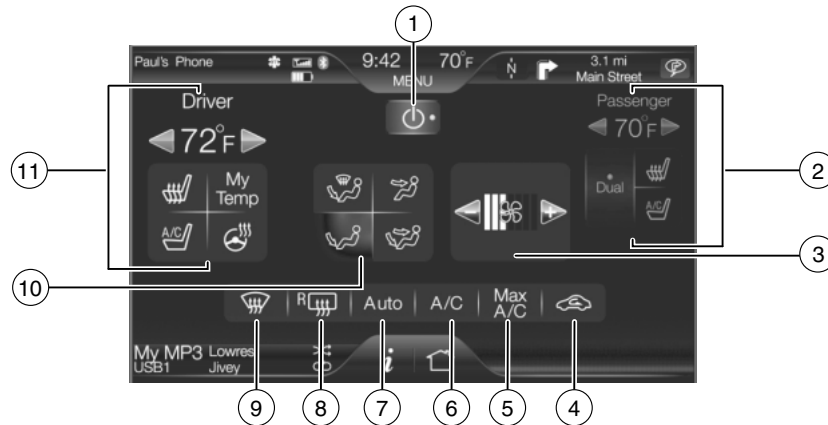

Touchscreen features

Press the lower right corner on the touchscreen to access these features.



1. **⏻ (Power):** Press to activate/deactivate the climate control system. When the system is off, outside air is prevented from entering the vehicle through the vents.









2. **Passenger settings:**

- Press DUAL to turn on passenger side temperature control.
- Press the red arrow to increase the temperature and press the blue arrow to decrease the temperature.
- Press  to control the heated seat. Refer to *Heated and cooled seats* in the *Seat and Safety Restraints* chapter.
- Press  to control the cooled seat. Refer to *Heated and cooled seats* in the *Seat and Safety Restraints* chapter.

3. **🌀 (Fan speed):** Press to + to increase or – to decrease fan speed.



4. **🔄 (Recirculated air):** Press to activate/deactivate air recirculation in the vehicle. Recirculated air may reduce the amount of time needed to cool down the interior of the vehicle and may also help reduce undesired odors from reaching the interior of the vehicle. Recirculated air engages automatically when MAX A/C is selected on can be engaged manually in any airflow mode except  (defrost). Recirculated air may turn off in all airflow modes except MAX A/C to reduce fog potential.

Climate Controls

5. **MAX A/C:** Press to distribute recirculated air through the instrument panel vents to cool the vehicle. This is more economical and efficient than normal A/C mode. Recirculated air may also help reduce undesirable odors from entering the vehicle. Press again for normal A/C operation.
6. **A/C:** Press to activate/deactivate air conditioning. Use with recirculated air to improve cooling performance and efficiency. Engages automatically in MAX A/C,  (defrost) and  (floor/defrost).
7. **AUTO:** Press to engage full automatic operation. Select the desired temperature using the temperature control. The system will automatically determine fan speed, airflow distribution, A/C on or off, and outside or recirculated air, to heat or cool the vehicle in order to reach the desired temperature.
8.  **(Rear defroster):** Press to activate/deactivate the rear window defroster. This button will also activate/deactivate the heated mirror (if equipped). Refer to *Rear window defroster* later in this chapter for more information.
9.  **(Defrost):** Press to distribute outside air through the windshield defroster vents and demister vents. Can be used to clear the windshield of fog and thin ice. The system will automatically provide outside air to reduce window fogging. Press this button again to return to the previous air flow selection. To return to full automatic control, press AUTO.
10. **Manual controls:** Select any of the following to determine where airflow is directed:
 -  : Distributes air through the windshield defroster vents, demister vents, floor vents and rear seat floor vents. The system will automatically provide outside air to reduce window fogging. To return to full automatic control, press AUTO.
 -  : Distributes air through the instrument panel vents. To return to full automatic control, press AUTO.
 -  : Distributes air through the instrument panel vents, demister vents, floor vents, rear seat floor vents. To return to full automatic control, press AUTO.
 -  : Distributes air through the demister vents, floor vents and rear seat floor vents. To return to full automatic control, press AUTO.
11. **Driver settings:**
 - Press the red arrow to increase the temperature and press the blue arrow to decrease the temperature.

40

Climate Controls

- Press  to control the heated seat. Refer to *Heated and cooled seats* in the *Seat and Safety Restraints* chapter.
- Press  to control the cooled seat. Refer to *Heated and cooled seats* in the *Seat and Safety Restraints* chapter.
- Press and hold MyTemp to select a temperature you would like the vehicle to remember and maintain for you.
- Press  (heated steering wheel) to activate your heated steering wheel (if equipped). **Note:** The wood on your heated steering wheel (if equipped) is not heated between the 10 and 2 positions.

Climate control voice commands

The following voice commands are available at the main menu level of a voice session. For example, press  and after the prompt, “Please say a command”, you may say any of the following commands:

- Climate On
- Climate Automatic
- Climate Temperature <15.5–29.5> degrees
- Climate Off
- Climate My Temperature
- Climate Temperature <60–85> degrees

There are additional climate control commands but in order to access them, you have to say “Climate” first, then when the system is ready to listen, you may say any of the following commands:

- Automatic
- Off
- A/C Off
- Max A/C On
- Defrost On
- Rear Defrost On
- Recirc On
- Panel On
- Floor On
- Temperature High
- Fan Increase
- Temperature
- Temperature Decrease
- Temperature <60–85> degrees
- Help
- Dual Off
- On
- A/C On
- Max A/C Off
- Defrost Off
- Rear Defrost Off
- Recirc Off
- Panel Floor On
- Windshield Floor On
- Temperature Low
- Fan Decrease
- Temperature Increase
- Temperature <15.5–29.5> degrees
- My Temp

Climate Controls

***Note:** If you have said “Temperature”, you can then say any of the following commands:

- High
- <15.5–29.5> degrees
- Low
- <60–85> degrees

For more information on your touchscreen system, refer to the *MyFord Touch™ / MyLincoln Touch™ supplement*.

REAR WINDOW DEFROSTER[Ⓜ]

The rear defroster control is located on the climate control panel and works to clear the rear window of fog and thin ice.

The engine must be running to operate the rear window defroster.

Press [Ⓜ] to turn the rear window defroster on. An indicator light on the button will illuminate when active. The rear window defroster turns off automatically after a predetermined amount of time, if a low battery condition is detected or when the ignition is turned to the off or accessory position. To manually turn off the rear window defroster at any time, press the control again.

If your vehicle is equipped with both rear defroster and heated mirrors, the same button will activate both. Refer to *Heated outside mirrors* in the *Driver Controls* chapter.

Do not use razor blades or other sharp objects to clean the inside of the rear window or to remove decals from the inside of the rear window. This may cause damage to the heated grid lines and will not be covered by your warranty.

REMOTE START CLIMATE OPERATION (IF EQUIPPED)

The climate control system will condition the cabin temperature during remote start. Engine idle may increase to help with adjusting the cabin temperature.

Note: No climate control adjustments will be recognized during remote start operation. Once the ignition is cycled to the on position, the climate control system will return to the previous settings (last ignition-on cycle) and adjustments can be made normally. If the previous setting was off, the climate control system will turn off.

Climate Controls

Automatic climate control

For hot weather conditions:

- The interior cabin will be cooled to 72°F (22°C).
- The cooled seats (if equipped) will be set to high.

For cold weather conditions:

- The interior cabin will be heated to 72°F (22°C).
- The heated seats (if equipped) will be set to high.
- Rear defrost/heated mirrors (if equipped) will be activated.

For moderate weather conditions:

- The interior cabin will be heated, cooled, or off, based upon the previous operating state (last ignition-on cycle).
- Heated/cooled seats (if equipped) will be deactivated.
- Rear defrost/heated mirrors (if equipped) will be deactivated.

CABIN AIR FILTER

The cabin air filter element is designed to reduce the concentration of airborne particles such as dust, spores and pollen in the air being supplied to the interior of the vehicle. The presence of a particulate filter element provides the following benefits:

- Improves your driving comfort by reducing particle concentration.
- Improves the interior compartment cleanliness.
- Protects the climate control components from particle deposits.

Note: A cabin air filter must be installed at all times to prevent foreign objects from entering the system. Running the system without a filter in place could result in degradation or damage to the system.

For replacement intervals regarding the cabin air filter, see the *scheduled maintenance information*. For more information regarding your filter, see your authorized dealer.

Lights

HEADLAMP CONTROL

- Turns the lamps off.
- ☰☉☰ Turns on the parking lamps, instrument panel lamps, license plate lamps and tail lamps.
- ☰☉ Turns the headlamps on.

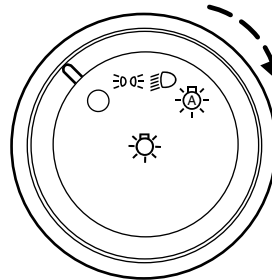

Adaptive headlamps (if equipped)

The headlamp beams move in the same direction as the steering wheel which provides more visibility when driving around curves.

- Without adaptive headlamps (1)
- With adaptive headlamps (2)

Note: The system has a power-up movement check feature. When the vehicle is started, the lamps track left to right, then back to center to alert the driver that the system is working properly. There is a delay of two to five seconds before the adaptive headlamp system will operate when the vehicle is driven, as the system is inactive below 3 mph (5 km/h).

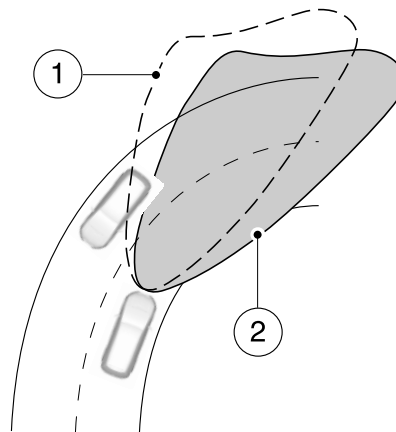

Autolamp control

The autolamp system provides light sensitive automatic on-off control of the exterior lights normally controlled by the headlamp control.

- To turn autolamps on, rotate the control to .
- To turn autolamps off, rotate the control from the autolamp position.

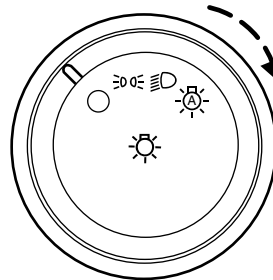

The autolamp system also keeps the lights on for a predetermined amount of time after the ignition switch is turned to off. You can change the amount of time the lamps stay on by using the programming procedure that follows:

Note: If the vehicle is equipped with autolamps, it will have the *headlamps on with windshield wipers feature*. If the windshield wipers are turned on, the exterior lamps will turn on with the headlamp control in the autolamp position.



Autolamp delay system (if equipped)

If your vehicle is equipped with autolamps, you can set the delay time to keep the headlights on for up to three minutes after the key is turned off. The delay time is set to 20 seconds at the factory, but the delay time may be changed by following the steps below (Steps 1 through 6 must be done within 10 seconds):

1. Turn the vehicle off.
2. Rotate the headlamp control to the autolamp position.
3. Rotate the headlamp control to the off position.
4. Turn the vehicle on.
5. Turn the vehicle off.
6. Turn the headlamp control to the autolamp position (the headlights should turn on).
7. Turn the headlamp control to the off position when the desired delay time (up to three minutes) has been reached.

Lights

Fog lamp control

The fog lamps can be turned on when the headlamp control is in the , , or  positions and the high beams are not turned on.

Press the top of the control, located on the instrument panel, to activate the fog lamps. The fog lamp indicator will illuminate when the fog lamps are on. Press the fog lamp control again to deactivate the fog lamps.

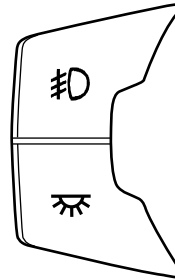

High beams

Pull the lever fully (to second detent) to activate. Pull the lever again to deactivate.

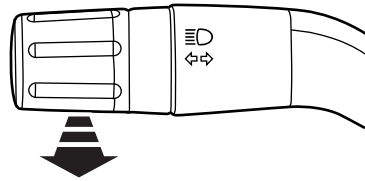

Flash-to-pass

Pull toward you slightly to activate and release to deactivate.

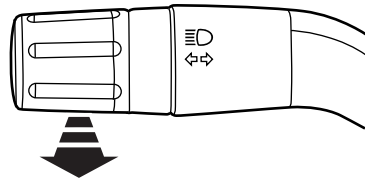

Daytime running lamps (DRL) (if equipped)

Turns the headlamps on at reduced intensity output. To activate:

- the ignition must be in the on position and
- the headlamp control must be in the off, autolamps or parking lamps position.

Lights



WARNING: Always remember to turn on your headlamps at dusk or during inclement weather. The Daytime Running Lamp (DRL) system does not activate the tail lamps and generally may not provide adequate lighting during these conditions. Failure to activate your headlamps under these conditions may result in a collision.

PANEL DIMMER CONTROL

Use to adjust the brightness of the instrument panel and all applicable lit components in the vehicle during headlamp and parking lamp operation.

- Tap the top or bottom of the control to brighten/dim all interior lit components incrementally, or
- Press and hold the top or bottom of the control until the desired lighting level is reached.

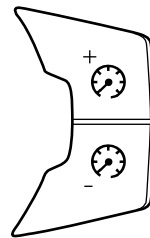

Note: If the battery is disconnected, discharged, or a new battery is installed, the dimmer control requires re-calibration. Press the dimmer control from the full dim position to the full on position to reset. This will ensure that your displays are visible under all lighting conditions.

Dome lamp control

Use to manually turn the dome lamp on.

- Press the bottom of the control. This will turn on the interior courtesy lights. The lights will remain on until the control is pressed again.

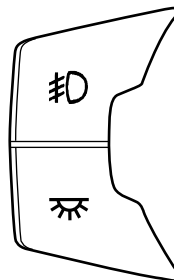

AIMING THE HEADLAMPS

The headlamps on your vehicle are properly aimed at the assembly plant. If your vehicle has been in an accident the alignment of your headlamps should be checked by your authorized dealer.

Lights

Vertical aim adjustment

1. Park the vehicle directly in front of a wall or screen on a level surface, approximately 25 feet (7.6 meters) away.

- (1) 8 feet (2.4 meters)
- (2) Center height of lamp to ground
- (3) 25 feet (7.6 meters)
- (4) Horizontal reference line

2. Measure the height of the headlamp bulb center from the ground and mark an 8 foot (2.4 meter) horizontal reference line on the vertical wall or screen at this height.

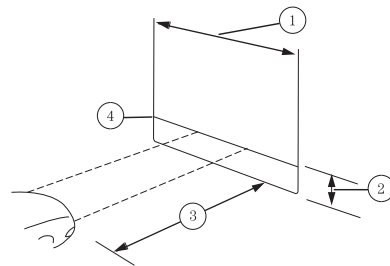

3. Turn on the low beam headlamps to illuminate the wall or screen and open the hood.

To see a clearer light pattern for adjusting, you may want to block the light from one headlamp while adjusting the other.

For vehicles with halogen headlamps:

On the wall or screen you will observe a flat zone of high intensity light located at the top of the right hand portion of the beam pattern. If the top edge of the high intensity light zone is not at the horizontal reference line, the headlamp will need to be adjusted.

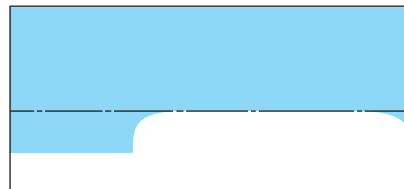

For vehicles with HID headlamps:

There is a distinct cut-off (change from light to dark) in the left portion of the beam pattern. The top edge of this cut-off should be positioned two inches (5 cm) below the horizontal reference line.

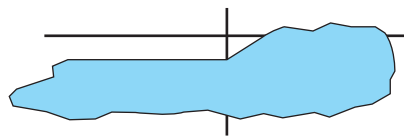

Lights

4. Locate the vertical adjuster on each headlamp. Using a Phillips #2 screwdriver, turn the adjuster either clockwise (to adjust down) or counterclockwise (to adjust up). The horizontal edge of the brighter light should touch the horizontal reference line.

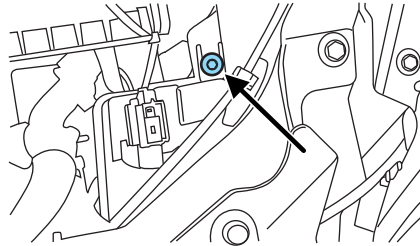

5. Close the hood and turn off the lamps.

HORIZONTAL AIM IS NOT REQUIRED FOR THIS VEHICLE AND IS NON-ADJUSTABLE.

TURN SIGNAL CONTROL

The turn signal lever does not mechanically lock in the upward or downward position when activated. The turn signal control activation and cancellation is electronic.

- To operate the left turn signal, push the lever down until it stops and release.
- To operate the right turn signal, push the lever up until it stops and release.
- To manually cancel turn signal operation, push the lever again in either direction.

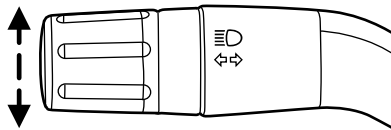

Lane change

To indicate a left or right lane change:

- Push the lever up/down to the first stop position and release. The turn signals will flash three times and stop.
- Push the lever up/down to the first stop position and hold. The turn signals will flash if the lever is held in this position.

Lights

INTERIOR LAMPS

Front row map lamps (if equipped)

To turn on the map lamps, press the outer edge of the clear lens. The front row map lamp lights when:

- any door is opened.
- the dome lamp button on the instrument panel is activated.
- the remote entry controls are pressed and the ignition is off.

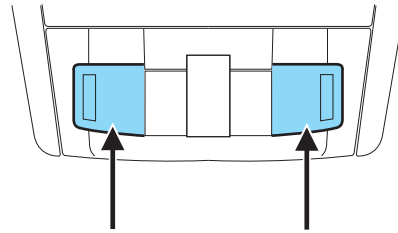

Map/dome lamp (if equipped)

The dome lamp lights when:

- any door is opened.
- the dome lamp button on the instrument panel is activated.
- any of the remote entry controls are pressed and the ignition is off.

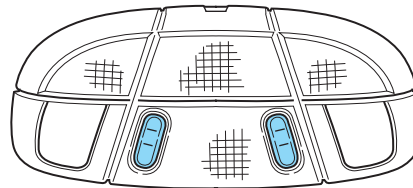

The map lamps are activated by pressing the controls on either side of the lens.

Rear courtesy lamp

Located in the rear cargo area, the courtesy lamp lights when:

- any door is opened.
- any of the remote entry controls are pressed and the ignition is off.

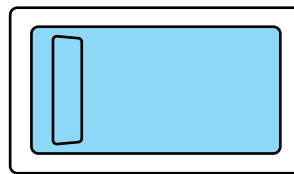

BULB REPLACEMENT

Lamp assembly condensation

Exterior lamps are vented to accommodate normal changes in pressure. Condensation can be a natural by-product of this design. When moist air enters the lamp assembly through the vents, there is a possibility that condensation can occur when the temperature is cold. When normal condensation occurs, a thin film of mist can form on the interior of the lens. The thin mist eventually clears and exits through the vents during normal operation. Clearing time may take as long as 48 hours under dry weather conditions.

Examples of acceptable condensation are:

- Presence of thin mist (no streaks, drip marks or droplets)
- Fine mist covers less than 50% of the lens

Examples of unacceptable moisture (usually caused by a lamp water leak) are:

- Water puddle inside the lamp
- Large water droplets, drip marks or streaks present on the interior of the lens

Take your vehicle to a dealer for service if any of the above conditions of unacceptable moisture are present.

Using the right bulbs

Replacement bulbs are specified in the chart below. Headlamp bulbs must be marked with an authorized "D.O.T." for North America and an "E" for Europe to ensure lamp performance, light brightness and pattern and safe visibility. The correct bulbs will not damage the lamp assembly or void the lamp assembly warranty and will provide quality bulb burn time.

| Function | Number of Bulbs | Trade Number |
|----------------------------------|-----------------|--------------------|
| Headlamp low/high beam (halogen) | 2 | HIR2 |
| * Headlamp low/high beam (HID) | 2 | D3S |
| * Front sidemarker lamp | N/A | LED |
| Front park/turn signal lamp | 2 | 3457NAK (amber) |

Lights

| Function | Number of Bulbs | Trade Number |
|--|-----------------|--------------|
| * Rear sidemarker lamp | N/A | LED |
| * Stop/tail/turn lamp | N/A | LED |
| Backup lamp | 2 | 921 |
| License plate lamp | 2 | C5W |
| * High-mount brake lamp | N/A | LED |
| Fog lamp (if equipped) | 2 | H11 |
| Front row map lamp | 2 | 1600XB |
| Second row dome/reading lamp | 3 | 211-2XB |
| Rear courtesy lamp | 1 | 211-2XB |
| Visor vanity lamp | 2 | 37 |
| All replacement bulbs are clear in color except where noted. | | |
| To replace all instrument panel lights - see your authorized dealer. | | |
| * To replace these lamps - see your authorized dealer. | | |

Replacing interior bulbs

Check the operation of all bulbs frequently.

Replacing exterior bulbs

Check the operation of all the bulbs frequently.

Replacing headlamp bulbs

Check the operation of all bulbs frequently.

1. Make sure that the headlamp control is in the off position.
2. Open the hood.
3. Remove the bulb cover.

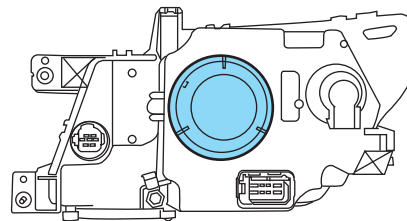

Lights

4. Turn the bulb holder counterclockwise and remove it.

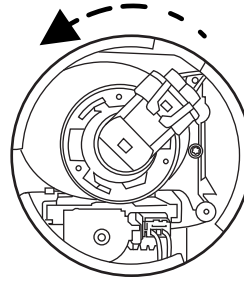

5. Disconnect the electrical connector.

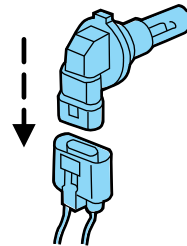

WARNING: Handle a halogen headlamp bulb carefully and keep out of children's reach. Grasp the bulb only by its plastic base and do not touch the glass. The oil from your hand could cause the bulb to break the next time the headlamps are operated.

6. Reverse the procedure to install the new bulb.

Replacing HID headlamp bulbs (if equipped)

The low beam headlamps on your vehicle use a "high intensity discharge" source. These lamps operate at a high voltage. When the bulb is burned out, the bulb and starter capsule assembly must be replaced by your authorized dealer.

Replacing front parking lamp/turn signal bulbs

1. Make sure the headlamp switch is in the off position, then open the hood.

Lights

2. At the wheel well, remove the fasteners from the splash shield, then pull the splash shield back to gain access to the bulbs.

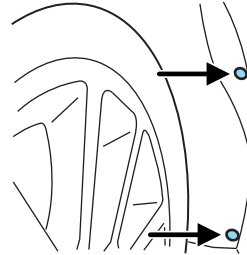

3. Rotate the bulb socket counterclockwise and remove from the lamp assembly.

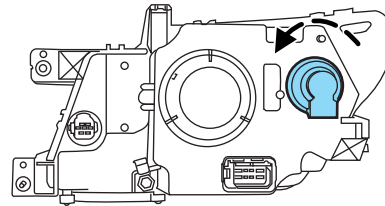

4. Carefully pull the bulb out of the socket.

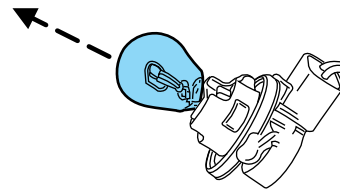

5. Reverse the procedure to install the new bulb.

Replacing side marker bulbs

Your vehicle is equipped with LED side marker bulbs. It is designed to last the life of the vehicle. If replacement is required, see your authorized dealer.

Lights

Replacing backup lamp bulbs

The backup lamp bulb is located in the lower portion of the tail lamp assembly. Follow the below steps to replace the bulb.

Note: Your vehicle is equipped with a tail/stop/turn/sidemarkers lamp assembly containing integral multiple light emitting diodes (LED). See your authorized dealer for the replacement LED module.

1. Make sure the headlamp switch is in the off position and then open the liftgate to expose the lamp assembly bolts.
2. Remove the two bolts from the lamp assembly.
3. Carefully remove the lamp assembly away from the vehicle by pulling the assembly straight out to expose the bulb socket. **DO NOT TIP THE LAMP ASSEMBLY SIDEWAYS.**
4. Rotate the bulb socket counterclockwise and remove from lamp assembly.
5. Pull bulb straight out of socket and snap in the new bulb.
6. Install the bulb socket into the lamp assembly and rotate clockwise.
7. Carefully install the tail lamp assembly on the vehicle by securing the lamp assembly with two bolts.

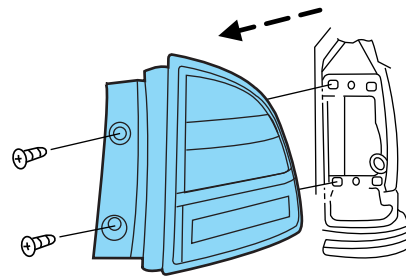

Replacing supplemental liftgate lamp assembly

Your vehicle is equipped with a liftgate lamp assembly containing integral multiple light emitting diodes (LED). If one or more LEDs burn out, the complete lamp module has to be replaced. See your authorized dealer for the replacement LED module.

Replacing high-mount brake lamp bulbs

Your vehicle is equipped with an LED center high-mount stop lamp. It is designed to last the life of the vehicle. If replacement is required, see your authorized dealer.

Lights

Replacing license plate lamp bulbs

1. Make sure the headlamp switch is in the off position.
2. Remove the two screws and the license plate lamp assembly from the liftgate.

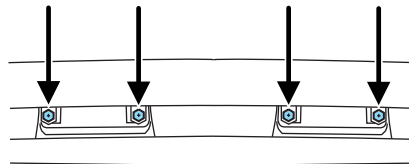

3. Carefully pull the bulb straight out from the lamp assembly.
- Install new bulb(s) in reverse order.

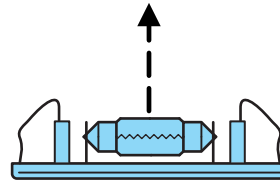

Replacing fog lamp bulbs

1. Make sure the fog lamp switch is in the off position.
 2. From underneath the vehicle, remove the splash shield and rotate the harness/bulb assembly counterclockwise, to remove from the fog lamp.
 3. Carefully disconnect the bulb from the harness assembly via the two snap clips.
- Install the new bulb in reverse order.

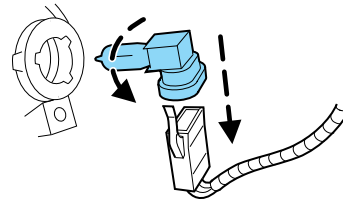

Driver Controls

WINDSHIELD WIPERS

Windshield wiper: Rotate the end of the control away from you to increase the speed of the wipers; rotate towards you to decrease the speed of the wipers.

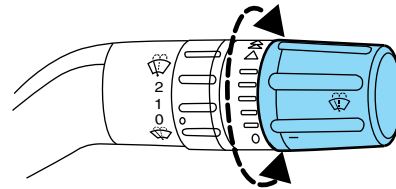

Speed dependent wipers (if equipped): When the wiper control is set to any of the interval settings except the longest pause setting, the pause time between wiping will automatically adjust with the vehicle speed. The faster your vehicle is travelling the shorter the pause time between wipes will become.

Rain-sensing wipers (if equipped): The rain-sensing wipers, designated with AUTO on the control, will automatically activate when moisture is present on the windshield and the control is set to one of five auto/interval moisture sensitivity settings. Rotate the end of the control toward the windshield to increase the sensitivity. The speed of the rain-sensing wipers will vary based on the amount of moisture detected on the windshield and the auto/interval setting. There are no interval (intermittent wipe) settings on vehicles with rain-sensing wipers. The wipers will continue to wipe as long as the presence of moisture is detected on the windshield. More or less wiping may occur depending on humidity, mist or light rain, or road spray.

This feature can be enabled/disabled through the message center. Refer to *Message center* in the *Instrument Cluster* chapter.

Keep the outside of the windshield clean, especially the area around the rear view mirror where the sensor is located or rain sensor performance may be affected.

Note: During winter driving conditions with ice, snow or a salty road mist, inconsistent or unexpected wiping or smearing may occur. In these conditions, you can lower the sensitivity to reduce the amount of smearing or override the feature by selecting low- or high-speed wiping or turning the wiper system off.

Note: The rain sensing wiper feature must be turned off before entering a car wash.

Driver Controls

Windshield washer: Press the end of the stalk:

- briefly: causes a single swipe of the wipers without washer fluid.
- a quick press and hold: the wipers will swipe three times with washer fluid.
- a long press and hold: the wipers and washer fluid will be activated for up to ten seconds.

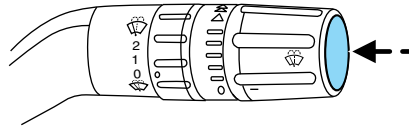

Note: Do not operate the washer when the washer reservoir is empty. This may cause the washer pump to overheat. Check the washer fluid level frequently. Do not operate the wipers when the windshield is dry. This may scratch the glass, damage the wiper blades and cause the wiper motor to burn out. Before operating the wiper on a dry windshield, always use the windshield washer. In freezing weather, be sure the wiper blades are not frozen to the windshield before operating the wipers.

Courtesy wipe feature: One extra wipe will occur a few seconds after washing the front window to clear any excess washer fluid remaining on the windshield. This feature can be enabled/disabled through the message center. Refer to *Message center* in the *Instrument Cluster* chapter.

Windshield wiper rainlamp feature (if equipped with autolamp)

When the windshield wipers are turned on during daylight, and the headlamp control is in the autolamp position, the exterior lamps will turn on after a brief delay and will remain on until the wipers are turned off.

Rear window wiper/washer controls

For rear wiper operation, rotate the rear window wiper and washer control to the desired position. Select:

- 2 — Intermittent operation (shortest pause between wipes).
- 1 — Intermittent operation (longest pause between wipes).
- 0 (off) — Rear wiper and washer off.

For rear wash cycle, rotate (and hold as desired) the rear wiper/washer control to either  position.

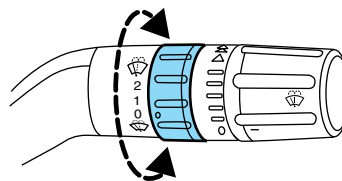

58

Driver Controls

From either position, the control will automatically return to the 2 or 0 (off) position.

Reverse wiper feature: The rear wiper will be automatically activated in an intermittent setting when shifting into R (Reverse) if the front wipers are activated. This feature may be enabled/disabled through the message center. Refer to *Message center* in the *Instrument Cluster* chapter.

TILT/TELESCOPE STEERING WHEEL (IF EQUIPPED)

To adjust the steering wheel:

1. Pull the lever down to unlock the steering column.
2. While the lever is in the down position, move the steering wheel up or down and in or out until you find the desired position.
3. While holding the steering wheel in place, pull the lever up to its original position to lock the steering column.

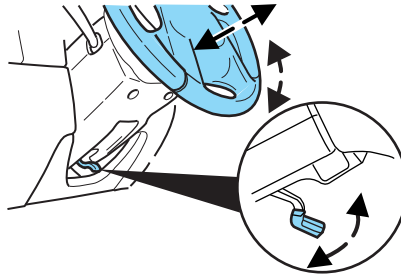

WARNING: Never adjust the steering wheel when the vehicle is moving.

Power tilt/telescope steering column (if equipped)

The steering column can be adjusted using the control on the side of the steering column. Press and hold the front or rear of the control to adjust the telescope. Press and hold the top or bottom of the control to adjust the tilt.

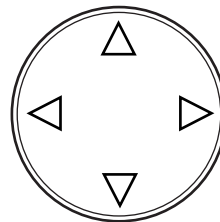

Driver Controls

Easy entry/exit feature

When the ignition is turned off, the column will move to the full up and in position if this feature is activated through the message center. Refer to *Message center* in the *Instrument Cluster* chapter. When the ignition is turned on, the column will return to the previous setting.

Note: The easy entry/exit feature will prevent the steering wheel from returning to the memory position until the ignition is turned off.

Memory feature (if equipped)

The steering column positions are saved when doing a memory set function and can be recalled along with the vehicle personality features when a memory position is selected through the remote entry transmitter, keyless entry keypad or memory switch on the instrument panel. Refer to *Front seating* in the *Seating and Safety Restraints* chapter.

If the steering column adjustment control is pressed during memory recall it will cancel the automatic operation and the column will respond to manual adjustment of the control.



WARNING: Never adjust the steering column when the vehicle is moving.

On vehicles with memory feature, to prevent damage to the steering column, the steering column is designed to set a stopping position just short of the end of the column position. If the steering column encounters an object while moving up or down, a new stopping position will be set. To reset the steering column to its normal stopping position:

- After encountering the new stopping position, press the steering column control again to override.
- Continue pressing the control until it reaches the end of the column position.
- A new soft stop will be automatically set. The next time the steering column is tilted it will stop just short of the end of the column position.

Driver Controls

ILLUMINATED VISOR MIRROR

Lift the mirror cover to turn on the visor mirror lamp.

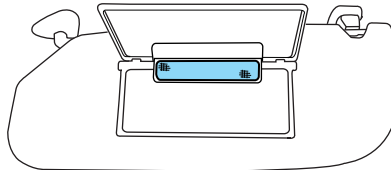

Slide-on-rod feature

The visor will slide back and forth on the rod for increased sunlight coverage. Rotate the visor towards the side window and extend it rearward for additional sunlight coverage.

Note: To stow the visor back into the headliner, visor must be retracted before moving it back towards the windshield.

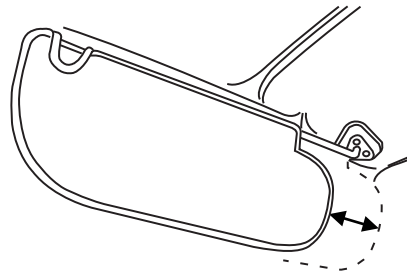

OVERHEAD CONSOLE

The appearance of your vehicle's overhead console will vary according to your option package.

Storage compartment

The storage compartment may be used to store a pair of sunglasses. Press the release area on the rear edge of the bin door to open the storage compartment. The door will open to the full open position.

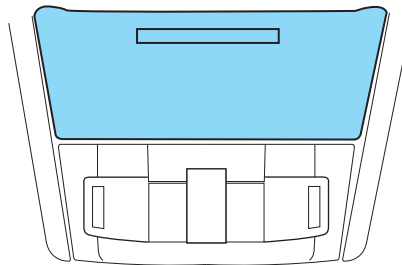

Driver Controls

CENTER CONSOLE

Your vehicle may be equipped with a variety of console features. These include:

1. Cupholders
2. Utility compartment with in-bin power point and a removable coin holder tray (two grooves on tray slide onto tracks in main bin).
3. Rear power point

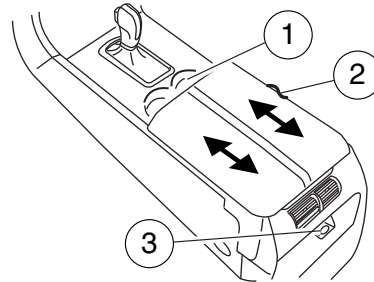

WARNING: Use only soft cups in the cupholder. Hard objects can injure you in a collision.

AUXILIARY POWER POINT (12V DC)

Power outlets are designed for accessory plugs only. Do not insert any other object in the power outlet as this will damage the outlet and blow the fuse. Do not hang any type of accessory or accessory bracket from the plug. Improper use of the power outlet can cause damage not covered by your warranty.

Auxiliary power points can be found in the following locations:

- On the passenger side of the center console near the instrument panel
- In the center console storage compartment
- On the rear side of the center console, accessible from the rear seats
- On the left rear quarter panel, accessible from the liftgate or behind the rear seat

Do not use the power point for operating the cigarette lighter element (if equipped).

To prevent the fuse from being blown, do not use the power point(s) over the vehicle capacity of 12V DC/180W. If the power point or cigar lighter socket is not working, a fuse may have blown. Refer to *Fuses and relays* in the *Roadside Emergencies* chapter for information on checking and replacing fuses.

Driver Controls

To have full capacity usage of your power point, the engine is required to be running to avoid unintentional discharge of the battery. To prevent the battery from being discharged:

- do not use the power point longer than necessary when the engine is not running,
- do not leave battery chargers, video game adapters, computers and other devices plugged in overnight or when the vehicle is parked for extended periods.

Always keep the power point caps closed when not being used.

POWER WINDOWS



WARNING: Do not leave children unattended in the vehicle and do not let children play with the power windows. They may seriously injure themselves.



WARNING: When closing the power windows, you should verify they are free of obstructions and ensure that children and/or pets are not in the proximity of the window openings.

Press and pull the window switches to open and close windows.

- Press down (to the first detent) and hold the switch to open.
- Pull up (to the first detent) and hold the switch to close.

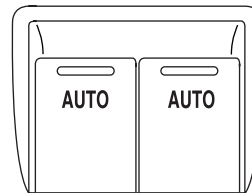

Rear Window Buffeting: When one or both of the rear windows are open, the vehicle may demonstrate a wind throb or buffeting noise. This noise can be alleviated by lowering a front window approximately 2–3 inches (5–8 cm).

One-touch up or down (front windows only)

This feature allows the driver or passenger's window to open or close fully without holding the control down.



To operate one-touch down, press the switch completely down to the second detent and release quickly. The window will open fully. Momentarily press the switch to any position to stop the window operation.

Driver Controls

To operate one-touch up, pull the switch completely up to the second detent and release quickly. The window will close fully. Momentarily press the switch to any position to stop the window operation.

Global open windows

Press and hold  to begin opening the two front windows and venting the panoramic roof (if equipped).

- The  control can then be released and the windows and panoramic roof will complete the opening operation.
- If  or  is pressed during the opening operation, both windows and panoramic roof movement will stop.

Note: The ignition must be off and the accessory delay feature must be not activated in order for this feature to operate.

Note: This feature can be disabled or enabled by your authorized dealer or through the message center. Refer to *Message center* in the *Instrument Cluster* chapter.

Bounce-back

When the window is moving upward and an obstacle or a rough road condition interferes with the window's movement, the window will automatically reverse direction and move down. This is known as "bounce-back". If the ignition is turned off (without accessory delay being active) during bounce-back, the window will move down until the bounce-back position is reached.

Security override

To override a bounce-back condition, within two seconds after the window reaches the bounce-back position, pull and hold the switch up and **the window will travel up with no bounce-back or pinch protection**. If the switch is released before the window is fully closed, the window will stop. For example, this can be used to overcome the resistance of ice on the window or seals.

Driver Controls

Window lock

The window lock feature allows only the driver and front passenger to operate the power windows.

To lock out all the window controls (except for the driver and front passenger) press the right side of the control. Press the left side to restore the window controls.

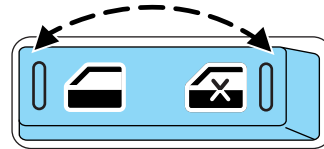

Accessory delay

With accessory delay, the audio system, power windows and moon roof (if equipped) operate for up to 10 minutes after the ignition is turned off or until either front door is opened.

INTERIOR MIRROR

The interior rear view mirror has two pivot points on the support arm which lets you adjust the mirror up or down and from side to side.



WARNING: Do not adjust the mirror while the vehicle is in motion.

Automatic dimming interior rear view mirror

The interior rear view mirror and a driver's side exterior mirror have an auto-dimming function. The electronic day/night mirrors will change from the normal (high reflective) state to the non-glare (darkened) state when bright lights (glare) reach the interior mirror. When the interior mirror detects bright light from behind the vehicle, the interior rear view mirror and the driver's side exterior mirror will automatically adjust (darken) to minimize glare.

The mirrors will automatically return to the normal state whenever the vehicle is placed in R (Reverse) to ensure a bright clear view when backing up.

Do not block the sensors on the front and back of the interior rear view mirror since this may impair proper mirror performance.

Note: A rear center passenger and/or raised rear center headrest (if equipped) may also block the light from reaching the sensor.

Do not clean the housing or glass of any mirror with harsh abrasives, fuel or other petroleum-based cleaning products.

65

Driver Controls

EXTERIOR MIRRORS

Power side view mirrors



WARNING: Do not adjust the mirror while the vehicle is in motion.

To adjust your mirrors:

1. Rotate the control clockwise to adjust the right mirror and rotate the control counterclockwise to adjust the left mirror.
2. Move the control in the direction you wish to tilt the mirror.
3. Return to the center position to lock mirrors in place.



Memory feature

The power side view mirror positions are saved when doing a memory set function and can be recalled along with the vehicle personality features when a memory position is selected through the remote entry transmitter, keyless entry keypad or memory switch on the driver's door. Refer to *Front seating* in the *Seating and Safety Restraints* chapter.

Automatic dimming feature

The driver's side view mirror has an auto-dimming function. For more information, refer to *Automatic dimming interior rear view mirror* in this chapter.

Heated outside mirrors

Both mirrors are heated automatically to remove ice, mist and fog when the rear window defrost is activated.

Do not remove ice from the mirrors with a scraper or attempt to readjust the mirror glass if it is frozen in place.

These actions could cause damage to the glass and mirrors.

Do not clean the housing or glass of any mirror with harsh abrasives, fuel or other petroleum-based cleaning products.

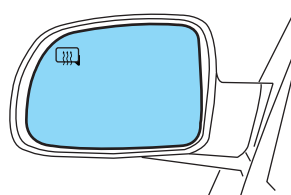

66

Driver Controls

Fold-away mirrors

Pull the side mirrors in carefully when driving through a narrow space, like an automatic car wash.

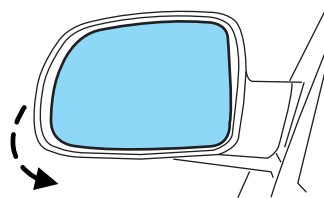

Blind spot mirrors (if equipped)

Your vehicle may be equipped with blind spot mirrors or a blind spot information system. Refer to *Blind spot mirrors* or *Blind spot information system (BLIS®) with cross traffic alert (CTA)* in the *Driving* chapter.

SPEED CONTROL (IF EQUIPPED)

With speed control set, you can maintain a set speed without keeping your foot on the accelerator pedal.



WARNING: Do not use the speed control in heavy traffic or on roads that are winding, slippery or unpaved.

Using speed control

The speed controls are located on the steering wheel. The following buttons work with speed control:

SET: Press to set a speed or to increase or decrease the set speed.

RES (Resume): Press to resume the set speed.

CNCL (Cancel): Press to cancel the set speed.

ON/OFF: Press to turn speed control on or off.

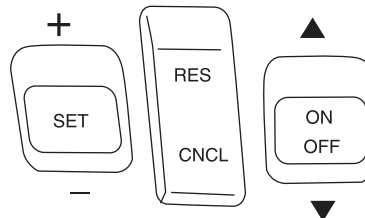

Setting speed control

To set speed control:

1. Press ON upward and release.

Driver Controls

2. Accelerate to the desired speed.
3. Press SET upward and release.
4. Take your foot off the accelerator pedal.
5. The indicator  light on the instrument cluster will turn on.

Note:

- Vehicle speed may vary momentarily when driving up and down a steep hill.
- If the vehicle speed increases above the set speed on a downhill, you may want to apply the brakes to reduce the speed.
- If the vehicle speed decreases more than 10 mph (16 km/h) below your set speed on an uphill, your speed control will disengage.

Disengaging speed control

To disengage the speed control, press the brake pedal or press and release CNCL. Disengaging the speed control will not erase the previous set speed.

Resuming a set speed

Press and release RES. This will automatically return the vehicle to the previously set speed.

Increasing speed while using speed control

To set a higher speed:

- Press SET upward and hold until you get to the desired speed, then release. You can also use SET to operate the tap-up function. Press SET upward and release to increase the vehicle set speed in 1 mph (1.6 km/h) increments.
- Use the accelerator pedal to get to the desired speed then press SET upward and release.

Reducing speed while using speed control

To reduce a set speed:

- Press SET downward and hold until you get to the desired speed, then release. You can also use SET to operate the tap-down function. Press SET downward and release to decrease the vehicle set speed in 1 mph (1.6 km/h) increments.
- Press the brake pedal until the desired vehicle speed is reached then press SET downward and release.

68

Driver Controls

Turning off speed control

To turn off the speed control, press OFF downward or turn off the ignition.

Note: When you turn off the speed control or the ignition, your speed control set speed memory is erased.

ADAPTIVE CRUISE CONTROL (ACC) (IF EQUIPPED)

Adaptive cruise control (ACC) is much like speed control, only this system is designed to automatically adjust your speed to maintain a proper distance between you and the vehicle in front of you in the same lane. The driver can select from one of four GAP settings, the controls are located on the steering wheel.

At startup, the system sets the gap to the last selected setting. Once activated, the driver can deactivate the system at any time by pressing the brake pedal, pressing the



steering wheel ON/OFF control or pressing the RES/CNCL control. In addition, the driver can temporarily increase the vehicle speed above the current speed by manually pressing on the accelerator pedal.



WARNING: Always pay close attention to changing road conditions, especially when using adaptive cruise control. Adaptive cruise control cannot replace attentive driving. Failing to follow any of the warnings below or failing to pay attention to the road may result in a collision, serious injury or death.



WARNING: Adaptive cruise control is not a collision warning or avoidance system. Additionally, adaptive cruise control will not detect:

- Stationary or slow moving vehicles below 6 mph (10 km/h).
- Pedestrians or objects in the roadway.
- Oncoming vehicles in the same lane.



WARNING: Do not use the adaptive cruise control when entering or leaving a highway, in heavy traffic or on roads that are winding, slippery or unpaved.

Driver Controls



WARNING: Do not use in poor visibility, specifically fog, rain, spray or snow.

Using adaptive cruise control

Note: It is the drivers responsibility to stay alert, drive safely and be in control of the vehicle at all times.

The controls for using your cruise control are located on the steering wheel.

SET: Press to set a speed or to change the set speed.

RES/CNCL (Resume/cancel):
Press to resume or cancel a set speed.

ON/OFF: Press to turn the system on or off.

GAP: Press to change the distance between your vehicle and the vehicle in front of you.

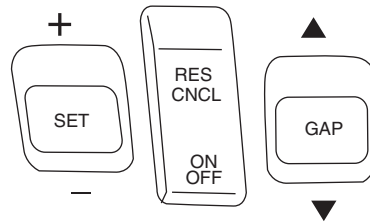

Setting adaptive cruise control

1. Press and release ON. The message center will display the gray ACC indicator light, current gap setting and SET.

2. Accelerate to the desired speed.

3. Press SET upward and release.

The vehicle speed will be stored in the memory and the message center will display a green ACC indicator light, current gap setting and desired set speed.

4. Take your foot off the accelerator pedal.

5. A lead vehicle graphic will illuminate if there is a vehicle detected in front of you.



Driver Controls

Following a vehicle



WARNING: When following a vehicle in front of you, the vehicle will not decelerate automatically to a stop, nor will the vehicle always decelerate quickly enough to avoid a collision without driver intervention. Always apply the brakes when necessary. Failing to do so may result in a collision, serious injury or death.

When a vehicle ahead of you enters the same lane or a slower vehicle is ahead in the same lane, the vehicle speed will adjust automatically to maintain a preset gap distance. The distance setting is adjustable, refer to *Setting the gap distance* in this section.

The lead vehicle graphic will be illuminated.

The vehicle will maintain a constant distance between the vehicle ahead until:

- The vehicle in front of you accelerates to a speed above the set speed.
- The vehicle in front of you moves out of your lane or out of view.
- The vehicle speed falls below 16 mph (26 km/h).
- A new gap distance is set.

The vehicle brakes will be automatically applied to slow the vehicle to maintain a safe distance between the vehicle in front. The maximum braking which is applied by the ACC system is limited and can be overridden by the driver applying the brakes.

If the ACC system predicts that its maximum braking level will not be sufficient, an audible warning will sound while the ACC continues to brake. This is accompanied by a heads-up display; a red warning bar illuminating on the windshield. The driver should take **immediate** action.

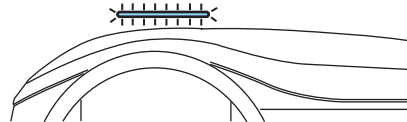

Note: The brakes may emit a sound when they are being modulated by the adaptive cruise control system.



WARNING: Adaptive cruise control only warns of vehicles detected by the radar sensor. In some cases there may be no warning or the warning may be delayed. The driver should always apply the brakes when necessary. Failing to do so may result in a collision, serious injury or death.

Driver Controls

Setting the gap distance

The distance between your vehicle and the vehicle in front of you can be decreased or increased by pressing the GAP control up or down. The selected gap will be displayed in the message center as shown by the bars in the graphic. Four gap distance settings are available.



| Graphic display (bars between vehicles) | Following distance | Following distance at 60 mph (96 km/h) | Dynamic behavior |
|---|--------------------|--|------------------|
| 1 bar | 1 second | 29 yards (26 m) | Sporty |
| 2 bars | 1.5 seconds | 44 yards (40 m) | Normal |
| 3 bars | 1.9 seconds | 56 yards (51 m) | Normal |
| 4 bars | 2.3 seconds | 66 yards (60 m) | Comfort |

Each time the vehicle is restarted, the last chosen gap for the current driver will be automatically selected.

Note: It is the driver's responsibility to select a gap appropriate to the driving conditions.

Disengaging adaptive cruise control

Press the brake pedal or press CNCL to disengage the adaptive cruise control. The last set speed will be displayed with a strikethrough.

Disengaging the adaptive cruise control will not erase your previous set speed.

Overriding adaptive cruise control



WARNING: Whenever the driver is overriding the ACC by pressing the accelerator pedal, the ACC will not automatically apply the brakes to maintain separation from any vehicle ahead.

The set speed and gap distance can be overridden by pressing the accelerator pedal.

When the driver is overriding ACC, the green  ACC light is illuminated, and the follow vehicle is not displayed in the message center. When the accelerator is released, the ACC function will operate again and vehicle speed will decrease to the set speed, or a lower speed if following a slower vehicle.

Driver Controls

Changing the set speed

There are three ways to change the set speed:

- Accelerate or brake to the desired speed and press SET upward and release.
- Increase or decrease the speed by holding SET upward or downward until the desired set speed is shown on the message center. The vehicle speed will gradually change to the selected speed.
- Increase or decrease the speed in increments of 1 mph (2 km/h) by briefly pressing the SET upward or downward.

The ACC may apply the brakes to slow the vehicle down to the new set speed. The set speed will display continuously in the message center while ACC is active.

Resuming the set speed

Press and release RES/CNCL. This will automatically return the vehicle to the previously set speed. The set speed will display continuously in the message center while ACC is active.

Note: Resume should only be used if the driver is aware of the set speed and intends to return to it.

Low speed automatic cancellation

ACC is not functional at vehicle speeds below 16 mph (26 km/h). Once the vehicle speed drops below 16 mph (26 km/h), an audible alarm will sound and the automatic braking will be released.

Hilly condition usage

It is recommended that the driver select a lower gear position when ACC is active in situations such as prolonged downhill driving on steep grades (i.e., driving in mountainous areas). In these situations, additional engine braking is needed to reduce the load on the vehicle's regular brake system to prevent them from overheating. For more information, reference *Automatic transmission operation* in the *Driving* chapter.

Note: If ACC is applying brakes for an extended period of time, an audible alarm will sound and ACC will shut down. This is to allow the brakes to cool down. When the brakes have cooled down, the ACC will again function normally.

Turning off cruise control

Press OFF to turn off the cruise control.

Note: When you turn off the cruise control or the ignition, your cruise control set speed memory is erased.

Driver Controls

Detection issues

The radar sensor has a limited field of vision. In some situations it may not detect vehicles at all or detect a vehicle later than expected.

Detection issues can occur:

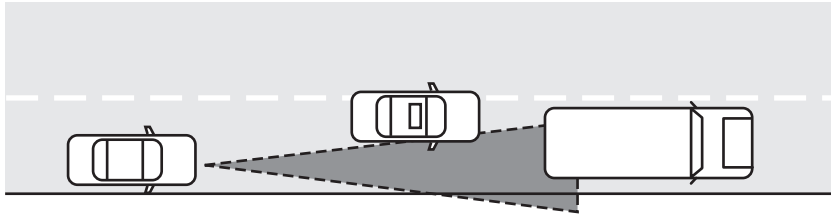

- When driving on a different line than the vehicle in front.

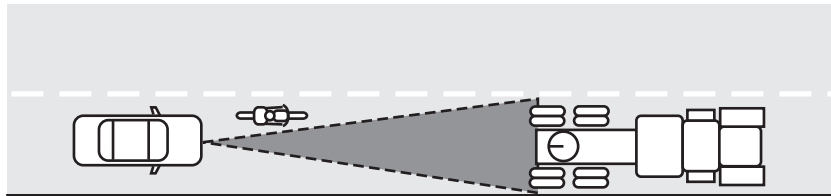

- With vehicles that edge into your lane. These vehicles can only be detected once they have moved fully into your lane.

Driver Controls

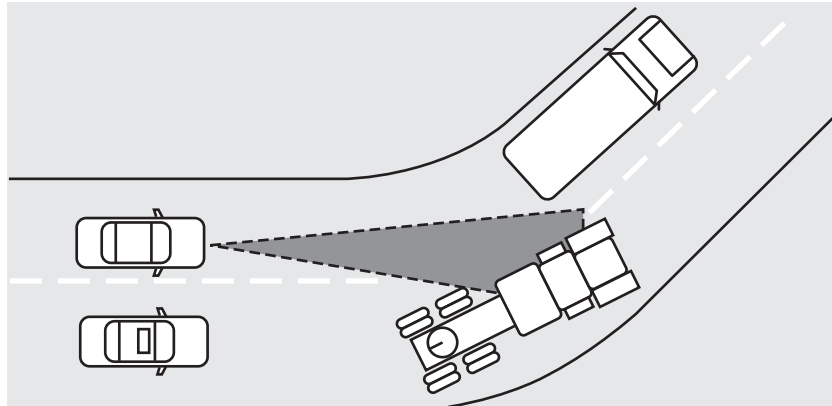

- There may be issues with the detection of vehicles in front when driving into and coming out of a bend or curve in the road.

In these cases ACC may brake late or unexpectedly. The driver should stay alert and intervene when necessary.

ACC Not Available

Several conditions exist which can cause ACC to deactivate or prevent ACC from activating when requested. These conditions include:

- The sensor is blocked, refer to *Blocked sensor* in this section.
- Brake temperature is high, refer to *Hilly condition usage* in this section.
- A failure has occurred in the ACC system or related system.

Blocked sensor

If a message regarding a blocked sensor is displayed, the radar signals from the sensor have been obstructed. The sensor is located behind a fascia cover near the driver side of the lower grille. When the radar signals are obstructed, a vehicle ahead cannot be detected and the ACC will not function. The following table lists possible causes and actions for this message being displayed.

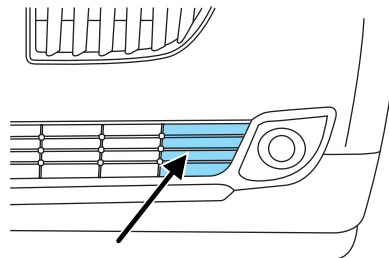

Driver Controls

| Cause | Action |
|--|--|
| The surface of the radar in the grille is dirty or obstructed in some way | Clean the grille surface in front of the radar or remove the object causing the obstruction |
| The surface of the radar in the grille is clean but the message remains in the display | Wait a short time. It may take several minutes for the radar to detect that it is no longer obstructed |
| Heavy rain or snow is interfering with the radar signals | Do not use ACC in these condition because it may not detect, warn, or respond to potential collisions. |
| Swirling water, or snow or ice on the surface of the road may interfere with the radar signals | Do not use ACC in these condition because it may not detect, warn, or respond to potential collisions. |

 **WARNING:** Do not use ACC when towing a trailer with brake controls. Aftermarket trailer brakes will not function properly when ACC is activated because the brakes are electronically controlled. Failing to do so may result in loss of vehicle control, which could result in serious injury.

 **WARNING:** Do not use tires sizes other than those recommended because this can affect the normal operation of ACC. Failing to do so may result in a loss of vehicle control, which could result in serious injury.

Switching to normal cruise control

You can manually change from adaptive cruise control (ACC) to normal cruise control through the message center. Refer to *Message center* in the *Instrument Cluster* chapter. If normal cruise control is selected, the ACC indicator light will be replaced with a  cruise control indicator light. The gap setting will not be displayed, the system will not automatically respond to lead vehicles and automatic braking will not be activated. The system will default to ACC when the engine is started.

 **WARNING:** Normal cruise control will not brake due to slower vehicles. Always be aware of which mode is selected and apply the brakes when necessary.

Driver Controls

STEERING WHEEL CONTROLS

Audio control features

SEEK: Press up or down to select the next/previous radio station preset, CD track or satellite radio channel (if equipped) preset depending on which media mode you are in.

MEDIA: Press repeatedly to scroll through available audio modes.

MUTE: Press to silence the radio.

VOL (Volume): Press up or down to increase or decrease the volume.

Navigation/SYNC® system hands-free control features (if equipped)

Press  to activate the voice recognition feature. Refer to *Voice recognition feature* in the *MyFord Touch™ / MyLincoln Touch™* supplement.

Press  to access phone features. Refer to *Phone features* in the *MyFord Touch™ / MyLincoln Touch™* supplement.

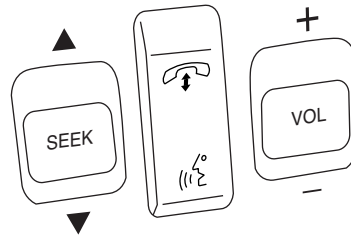
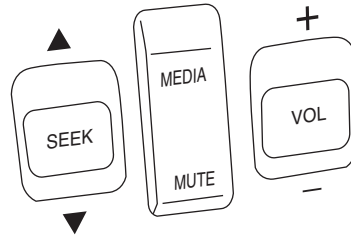

Cluster display control features

Some features can be adjusted through the right side of the cluster display. Use the right steering wheel control to navigate the screen and press OK to select. The following features are available:

- Entertainment
 - Change audio source
 - Limited play list
- Navigation (if equipped)
 - Redundant center stack display
 - Routed map



Driver Controls

- Phone
 - Redundant center stack display
 - Favorite contacts
- Climate
 - On
 - Fan speed
 - Temperature

PANORAMIC VISTA ROOF™ AND POWER SUNSHADES (IF EQUIPPED)

The panoramic Vista Roof™ and power sunshade controls are located on the overhead console.



WARNING: Do not let children play with the panoramic Vista Roof™ and power sunshade or leave children unattended in the vehicle. They may seriously hurt themselves.



WARNING: When closing the panoramic Vista Roof™ and power sunshade, you should verify that it is free of obstructions and ensure that children and/or pets are not in the proximity of the panoramic Vista Roof™ and power sunshade opening.

Note: Do not attempt to move the panoramic power sunshades manually or sunshade damage or malfunction may occur. The sunshade track clips are designed to release the sunshade crossbar in order to prevent damage to the system. If this occurs the sunshade crossbar ends may just need to be slid back into position to regain proper function. See your authorized dealer for proper panoramic Vista Roof™ or sunshade operating, diagnostic or repair instructions.

Note: The same  control operates both the sunshades and the panoramic Vista Roof™.

The panoramic Vista Roof™ and power sunshade are equipped with an automatic, one-touch, express opening feature. To stop motion at any time during the one-touch operation, press the control a second time.

Driver Controls

To open power sunshades and panoramic Vista Roof™: Press and release the  control to open the sunshade. The front and rear sunshades open simultaneously.

Note: Vista Roof™ will only open after power sunshades are completely open. Power sunshades will only close after Vista Roof™ is completely closed.

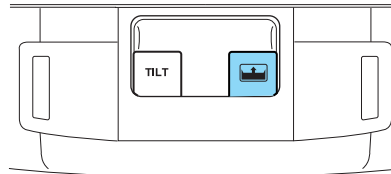

To open the panoramic Vista Roof™ press and release the  control. The panoramic Vista Roof™ will open to the “comfort” position. Press and release the control again to fully open. To stop the one-touch open feature press the control again.

Note: The “comfort” position helps to alleviate rumbling wind noise which may happen in the vehicle with the roof fully opened.

To close the panoramic Vista Roof™ and power sunshades: Pull the  control down and release. The glass panel will stop at the “express close” position. Firmly pull the control again and hold to fully close the Vista Roof™. Pull the control down and release to close the sunshades to the “express close” position. Firmly pull the control again and hold to fully close the front and rear sunshades.

To vent the panoramic Vista Roof™: From the closed position, press and release the TILT control. To close, pull and hold the TILT control down.

Note: If the panoramic Vista Roof™ is excessively operated, the glass and shade motors will automatically go into a fail-safe jog mode (manual intermittent operation) to prevent overheating and/or damage to the motor. The motors will revert back to normal operation after a period of idle time.

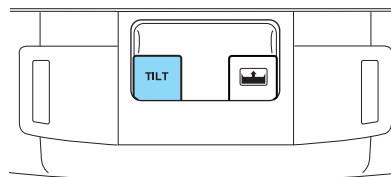

UNIVERSAL GARAGE DOOR OPENER (IF EQUIPPED)

Your vehicle may be equipped with a universal garage door opener which can be used to replace the common hand-held transmitter.

Driver Controls

HomeLink® Wireless Control System (if equipped)

The HomeLink® Wireless Control System, located on the driver's visor, provides a convenient way to replace up to three hand-held transmitters with a single built-in device. This feature will learn the radio frequency codes of most transmitters to operate garage doors, entry gate operators, security systems, entry door locks, and home or office lighting.

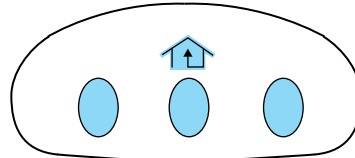

WARNING: When programming your HomeLink® Wireless Control System to a garage door or gate, be sure that people and objects are out of the way to prevent potential injury or damage.

Do not use the HomeLink® Wireless Control System with any garage door opener that lacks safety stop and reverse features as required by U.S. federal safety standards (this includes any garage door opener model manufactured before April 1, 1982). A garage door which cannot detect an object, signaling the door to stop and reverse, does not meet current U.S. federal safety standards. For more information, contact HomeLink® at: www.homelink.com or **1-800-355-3515**.

Retain the original transmitter for use in other vehicles as well as for future programming procedures (i.e. new HomeLink® equipped vehicle purchase). It is also suggested that upon the sale of the vehicle, the programmed Homelink® buttons be erased for security purposes, refer to *Programming* in this section.

Programming

Do not program HomeLink® with the vehicle parked in the garage.

Note: Your vehicle may require the ignition switch to be turned to the accessory position for programming and/or operation of the HomeLink®. It is also recommended that a new battery be placed in the hand-held transmitter of the device being programmed to HomeLink® for quicker training and accurate transmission of the radio-frequency signal.

Driver Controls

1. Position the end of your hand-held transmitter 1–3 inches (2–8 cm) away from the HomeLink® button you wish to program (located on your visor) while keeping the indicator light in view.

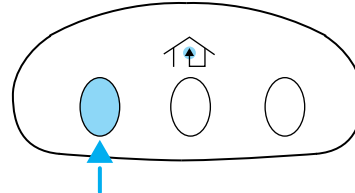

2. Simultaneously press and hold both the chosen HomeLink® and hand-held transmitter buttons until the HomeLink® indicator light changes from a slow to a rapidly blinking light. Now you may release both the HomeLink® and hand-held transmitter buttons.

Note: Some entry gates and garage door openers may require you to replace Step 2 with procedures noted in the *Gate Operator and Canadian Programming* in this section for Canadian residents.

3. Firmly **press and hold for five seconds and release** the programmed HomeLink® button up to two separate times to activate the door. If the door does not activate, press and hold the just-trained HomeLink® button and observe the indicator light.

- If the indicator light **stays on constantly, programming is complete** and your device should activate when the HomeLink® button is pressed and released.
- If the indicator light blinks **rapidly for two seconds and then turns to a constant light continue with “Programming” Steps 4 through 6** to complete programming of a rolling code equipped device (most commonly a garage door opener).

4. At the garage door opener receiver (motor-head unit) in the garage, locate the “learn” or “smart” button (usually near where the hanging antenna wire is attached to the unit).

5. Firmly press and release the “learn” or “smart” button. (The name and color of the button may vary by manufacturer.)

Note: There are 30 seconds in which to initiate Step 6.

6. Return to the vehicle and firmly **press, hold for two seconds and release** the programmed HomeLink® button. Repeat the **press/hold/release** sequence again and, depending on the brand of the garage door opener (or other rolling code equipped device), repeat this sequence a third time to complete the programming.

HomeLink® should now activate your rolling code equipped device. To program additional HomeLink® buttons begin with Step 1 in this section. For questions or comments, please contact HomeLink® at www.homelink.com or 1-800-355-3515.

Driver Controls

Gate Operator & Canadian Programming

During programming, your hand-held transmitter may automatically stop transmitting — not allowing enough time for HomeLink® to accept the signal from the hand-held transmitter.

After completing Step 1 outlined in the *Programming* section, replace Step 2 with the following:

Note: If programming a garage door opener or gate operator, it is advised to unplug the device during the “cycling” process to prevent overheating.

- Continue to press and hold the HomeLink® button (note Step 2 in the *Programming* section) while you press and release — **every two seconds** (“cycle”) your hand-held transmitter until the frequency signal has been accepted by the HomeLink®. The indicator light will flash slowly and then rapidly after HomeLink® accepts the radio frequency signal.
- Proceed with Step 3 in the *Programming* section.

Operating the HomeLink® Wireless Control System

To operate, simply press and release the appropriate HomeLink® button. Activation will now occur for the trained product (garage door, gate operator, security system, entry door lock, or home or office lighting etc.). For convenience, the hand-held transmitter of the device may also be used at any time. In the event that there are still programming difficulties, contact HomeLink® at **www.homelink.com** or **1-800-355-3515**.

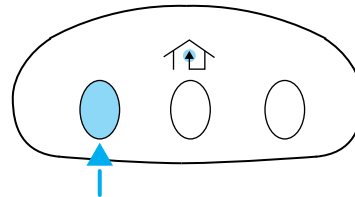
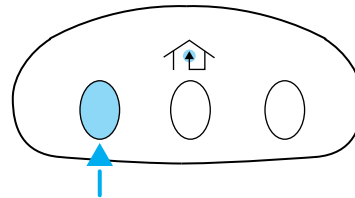

Driver Controls

Erasing HomeLink® buttons

To erase the three programmed buttons (individual buttons cannot be erased):

- Press and hold the two outer HomeLink® buttons until the indicator light begins to flash-after 20 seconds. Release both buttons. Do not hold for longer than 30 seconds.

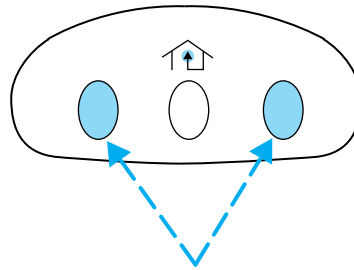

HomeLink® is now in the train (or learning) mode and can be programmed at any time beginning with Step 1 in the *Programming* section.

Reprogramming a single HomeLink® button

To program a device to HomeLink® using a HomeLink® button previously trained, follow these steps:

1. Press and hold the desired HomeLink® button. **Do NOT** release the button.
2. The indicator light will begin to flash after 20 seconds. Without releasing the HomeLink® button, follow Step 1 in the *Programming* section.

For questions or comments, contact HomeLink® at www.homelink.com or **1-800-355-3515**.

POSITIVE RETENTION FLOOR MAT



WARNING: Do not install additional floor mats on top of the factory installed floor mats as they may interfere with the accelerator or the brake pedals.

Driver Controls

Position the floor mat so that the eyelet is over the pointed end of the retention post and rotate forward to lock in. Make sure that the mat does not interfere with the operation of the accelerator or the brake pedal. To remove the floor mat, reverse the installation procedure.

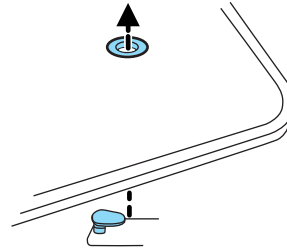

POWER LIFTGATE

You can power open or close the liftgate with the following controls:

- Instrument panel control button
- Transmitter button
- Outside liftgate control button
- Control button in the rear cargo area

Opening and closing the power liftgate:



WARNING: Make sure all persons are clear of the power liftgate area before using the power liftgate control.



WARNING: Keep keys out of reach of children. Do not allow children to play near an open or moving power liftgate.

The liftgate will only operate with the vehicle in P (Park).

When the liftgate is being power closed, a chime will sound three times as the liftgate begins to power close. A single chime indicates a problem with the close request, caused by:

- the ignition is on and the transmission is not in P (Park);
- or the battery voltage is below the minimum operating voltage;
- or the vehicle speed is at or above 3 mph (5 km/h).

If the liftgate reverses and starts to close after an open request, a fast continuous chime indicates excessive load on the gate or a possible strut failure. If any excessive load is removed and you still have a faster chime, have the system serviced immediately by your authorized dealer.

Do not attempt to manually force the liftgate to travel faster than the power system will permit. This will activate the obstacle detection feature.

84

Driver Controls

Note: Cycling the ignition prior to completely latching the liftgate could result in damage to the liftgate and/or its power components. Make sure the liftgate is fully latched before operating the vehicle.

Care should be exercised in starting the engine before the liftgate is fully closed (latched). If the ignition is cycled during a liftgate power close cycle and the liftgate is 6–10 inches (15–24 cm) from being latched, the liftgate may reverse to the full open position. Verify that the gate is closed before operating or moving the vehicle, especially in an enclosure, like a garage or a parking structure. The liftgate or its components could be damaged in an enclosure if the liftgate is open while the vehicle is being operated.

When power operating the liftgate at temperatures below 32°F (0°C), the liftgate may stop about 5 inches (12.7 cm) from the full open position. The liftgate can be fully opened by pushing it upward to the maximum open position.

The power liftgate feature can be enabled or disabled using the message center controls. With the setting turned off, power operation is disabled from the liftgate handle button and from the rear cargo area button. The transmitter and instrument panel switch will still continue to operate the liftgate regardless of the position state of the message center. Refer to *Message center* in the *Instrument Cluster* chapter.

To power open or close the liftgate from the instrument panel:

Press the button, located to the left of the steering column, once to power open or close the liftgate.

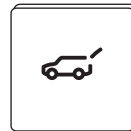

To power open or close the liftgate with the transmitter:

Press  twice within three seconds to power open or close the liftgate. Refer to *Remote entry system* in the *Locks and Security* chapter.

Driver Controls

To power open the liftgate with outside liftgate control button:

1. Unlock the liftgate with the transmitter or power door unlock control. If the intelligent access transmitter is within 3 feet (1 meter) of the liftgate, the liftgate will unlock when you press the liftgate release button.

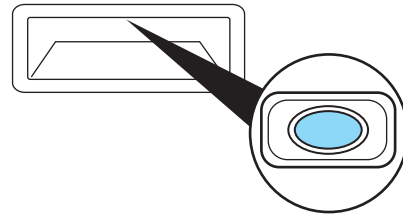

2. To open the liftgate, press the control button located in the top of the liftgate pull cup handle.

Note: For the best performance allow the power system to open the liftgate after pressing the control. Manually pushing or pulling the liftgate may activate the system's obstacle detection feature and stop the power operation.

To power close the liftgate with the rear cargo area control button:

Press and release the control on the left rear quarter panel to close the liftgate.

Note: The rear cargo area control button is disabled when the liftgate is latched.

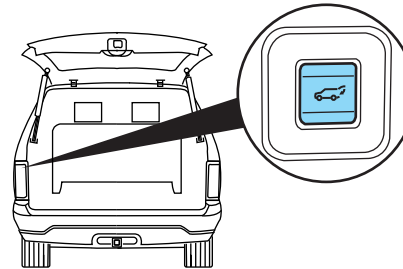

WARNING: Keep clear of the liftgate when activating the rear switch.

Note: The liftgate movement direction can be reversed with a second press of the instrument panel, or the rear cargo area control button, or a second double press of the transmitter button.

To manually operate the liftgate:

1. Disable the liftgate power function. Refer to *Message center* in the *Instrument Cluster* chapter.

2. Open and close the liftgate as you would a standard liftgate. Refer to *Manual liftgate operation* in this chapter.

Note: In case of operation in extreme cold -40°F (-40°C), or on extreme inclines, manual operation of the liftgate is suggested.

86

Driver Controls

Obstacle detection:

The power liftgate system is equipped with an obstacle detection feature.

If the power liftgate is closing, the system will reverse to full open when it detects an obstacle. A chime will sound three times when an obstacle is detected as the liftgate begins to reopen. Once the obstacle is removed, the liftgate can be closed under power.

If the power liftgate is opening, the system will stop and a chime will sound three times when an obstacle is detected. Once the obstacle is removed, the liftgate can again be operated normally.

Resetting the power liftgate:

The power liftgate may not operate properly and may need to be reset if any of these conditions occur:

- a low voltage or dead battery
- disconnected battery
- the liftgate is manually closed and left ajar (unlatched)

To reset the power liftgate:

1. Disconnect the battery for 20 seconds then, reconnect the battery.
2. Manually close and fully latch the liftgate.
3. Power open the liftgate by using the transmitter, or the instrument panel control button.

Note: If the power liftgate system is turned off in the message center, the system cannot be activated with the outside release handle or rear cargo area control button. The system will need to be turned on to resume operation with the outside release handle or rear cargo area control button. The power liftgate is still operational through the use of the remote entry transmitter and instrument panel button when the power liftgate is turned off in the message center.

Driver Controls

Manual liftgate operation

The liftgate cargo area is only intended for cargo, not for passengers.

To open the liftgate, press the button located in the top of the liftgate pull cup handle to unlatch the liftgate, then pull on the handle.

- Exercise care when opening or closing the liftgate in a garage or other enclosed area. The liftgate could be damaged against a garage door, low ceiling or wall.
- Do not hang anything (bike rack, etc.) from the spoiler/glass or liftgate. Doing so could cause serious damage to the liftgate and its components.
- Do not leave the liftgate open while driving. Doing so could cause serious damage to the liftgate and its components as well as allowing carbon monoxide to enter the vehicle.

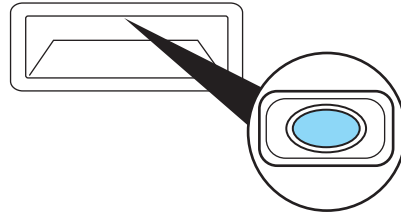

WARNING: Make sure that the liftgate is closed to prevent exhaust fumes from being drawn into the vehicle. This will also prevent passengers and cargo from falling out. If you must drive with the liftgate door open, keep the vehicle well ventilated so outside air comes into the vehicle.

Liftgate ajar signal

If the liftgate is not fully latched, you will receive a “LIFTGATE AJAR” message on the instrument panel. If you see this message, check the liftgate door to ensure it is fully latched.

Note: In the event of a power failure, the latch can be accessed and released from the inside using the access panel on the liftgate trim.

Driver Controls

CARGO AREA FEATURES

Cargo management system (if equipped)

The cargo management system consists of storage compartments located in the floor of the rear cargo area.

1. To open, lift the release handle and the lid.
2. To close, lower the lid.

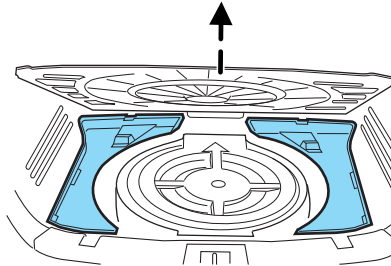

Cargo net (if equipped)

The cargo net secures lightweight objects in the cargo area. Attach the net to the loops and anchors provided.



WARNING: This net is not designed to restrain objects during a collision.

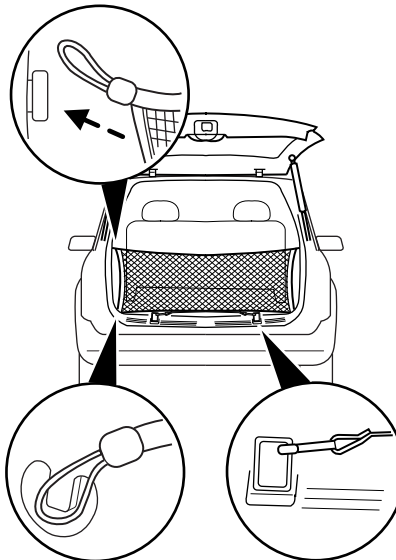

Driver Controls

Utility hook

The utility hook can be used to hang small items such as grocery bags, etc. Do not hang more than 10 lb (4.5 kg) on the hook.

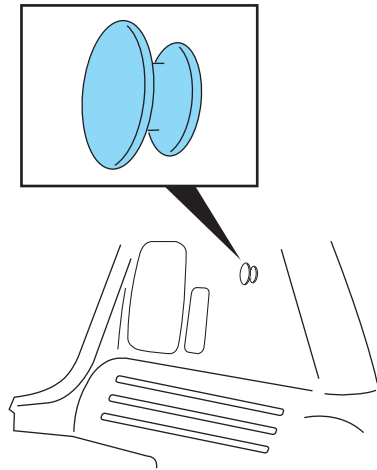

ROOF RACK SYSTEM (IF EQUIPPED)

Loads should never be placed directly on the roof panel. For proper function of the roof rack system, loads must be placed directly on crossbars affixed to the roof rack side rails. Your vehicle may be equipped with factory-installed crossbars. Ford Genuine Accessory crossbars, designed specifically for your vehicle, are also recommended for use with your roof rack system.

The vehicle's roof panel is **NOT** designed to directly carry a load. **The maximum recommended load is 100 lb (45 kg), evenly distributed on the crossbars.** Ensure that the load is securely fastened.

 **WARNING:** When loading the roof rail crossbars, it is recommended to evenly distribute the load, as well as maintain a low center of gravity. Loaded vehicles, with higher centers of gravity, may handle differently than unloaded vehicles. Extra precautions, such as slower speeds and increased stopping distance, should be taken when driving a heavily loaded vehicle.

When the rail system is loaded, check the tightness of the load before driving and at each fuel stop.

90

Locks and Security

INTELLIGENT ACCESS KEY (IA KEY)

Your vehicle is equipped with two intelligent access keys which operate the power locks and the remote entry system. The IA key must be in the vehicle to activate the push button start system.

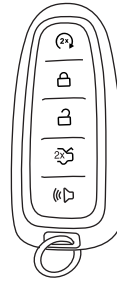

The IA key also contains a removable mechanical key blade that can be used to unlock the driver door. To release the mechanical key blade, slide the release on the back of the transmitter and pull the blade out.

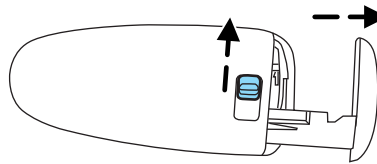

Your IA keys are programmed to your vehicle. You cannot enter or start your vehicle with an unprogrammed key. If you lose one or both of your IA keys, replacements are available from your authorized dealer. For more information on programming replacement IA keys, refer to the *SecuriLock® passive anti-theft system* section in this chapter.

Note: Your vehicle's IA backup keys were issued with a security tag that provides important vehicle key cut information. It is recommended that you keep the tag in a safe place for future reference.



MYKEY™

The MyKey™ feature allows you to program a restricted driving mode to promote good driving habits. All but one of the keys programmed to the vehicle can be activated as a MyKey™. The key will remain restricted until MyKey™ is cleared. Any remaining keys are referred to as an "administrator key" or admin key. The admin key can be used to create a MyKey™, program optional MyKey™ settings, and clear the MyKey™

91

Locks and Security

feature. When the MyKey™ feature is enabled the user can use system check in the message center to see how many MyKeys™ and admin keys are programmed to the vehicle, and see the total distance the vehicle has been driven with the MyKey™ active.

MyKey™ restricted features

Standard settings – these settings cannot be changed

- The audio system will be muted whenever Belt-Minder® is activated until the safety belts are buckled. Refer to the *Seating and Safety Restraints* chapter for a detailed description of Belt-Minder® operation.
- Low fuel warnings are displayed in the message center followed by a chime when the distance to empty value reaches 75 miles (120 km).
- If equipped, any of the following: parking aid, Blind Spot Information System (BLIS™) with cross traffic alert and forward collision warning systems cannot be turned off.

Optional settings – these settings can be changed

- Vehicle speed is limited to 80 mph (130 km/h). Visual warnings are displayed followed by a chime when the vehicle speed has reached 80 mph (130 km/h).
- Visual warnings are displayed followed by a chime when a preselected vehicle speed of 45, 55 or 65 mph (75, 90, or 105 km/h) is exceeded.
- The maximum volume of the audio system is limited to 45%. MYKEY VOLUME LIMITED will be displayed in the audio system display when attempting to exceed the limited volume.
- The AdvanceTrac® system cannot be turned off. When this optional setting is on, the MyKey™ user will not be able to deactivate the system. **Note:** It may be beneficial to deactivate the AdvanceTrac® system if the vehicle is stuck in snow, mud, or sand.

Create a MyKey™

To program MyKey™ on one of the keys programmed to the vehicle, put the intelligent access key in the backup slot with brand logo facing up; see the *Driving* chapter for the location of the backup slot. Turn the ignition on. Use the message center buttons to do the following:

1. Get into main menu, select SETTINGS then MYKEY by pressing OK button or the right arrow button.
2. Press OK to select CREATE MYKEY.
3. Hold the OK button as prompted until you see a message that the key is restricted.

92

Locks and Security

MyKey™ is successfully programmed. Make sure you label it so you can distinguish it from the admin keys. **Note:** To program the optional settings go to Step 2 in the *Programming MyKey™ optional settings* section. If your vehicle is equipped with remote start, see the *Using MyKey™ with remote start systems* section.

Note: All MyKeys™ can be cleared within the same key cycle that it was created, otherwise an admin key is required to clear the MyKey™ programming. To clear all MyKeys™ go to Step 2 in the *Clear MyKey™* section.

Programming MyKey™ optional settings

Turn the ignition on using an admin key. To program the optional settings, use the message center buttons to do the following:

1. Get into main menu, select SETTINGS then MYKEY by pressing the OK button or the right arrow button.
2. Use the up and down arrow buttons to get to any optional feature.
3. Press the right arrow button to bring up settings of each item.
4. Press OK button or right arrow button to make your choice.

Clear MyKey™

To reset all MyKeys™ as admin keys do the following:

1. At the main menu screen select SETTINGS then MYKEY by pressing OK or the right arrow key.
2. Press the down arrow key to get to CLEAR MYKEYS.
3. Hold OK until you see ALL MYKEYS CLEARED.

Check MyKey™ system status

The vehicle's message center information menu will provide the status of the following MyKey™ parameters:

- MYKEY MILES (km) — This odometer only tracks distance when a MyKey™ is used. If distance does not accumulate as expected, then the MyKey™ is not being used by the intended user. The only way to reset this odometer to zero is by clearing MyKey™. If this odometer is lower than the last time you checked, then the MyKey™ system has been recently cleared.
- # MYKEY(S) PROGRAMMED — Indicates how many MyKeys™ are programmed to the vehicle. Can be used to detect deletion of a MyKey™.
- # ADMIN KEYS PROGRAMMED — Indicates how many admin keys are programmed to the vehicle. Can be used to detect if an additional spare key has been programmed to the vehicle.

Locks and Security

Refer to *Message center* in the *Instrument Cluster* chapter for MyKey™ system warnings displays.

Using MyKey™ with remote start systems

MyKey™ is not compatible with non Ford-approved aftermarket remote start systems. If you choose to install a remote start system please see your authorized dealer for a Ford-approved remote start system.

The following information MAY help customers who choose to use a non Ford-approved remote start system. The actions proved below do NOT make MyKey™ compatible with non Ford-approved remote start system, but it MAY help you to retain some MyKey™ functions.

Vehicles equipped with an intelligent access key (push button start)

- It is not possible to program any remote start system as MyKey™ on vehicles equipped with intelligent access key (push button start). Therefore, you should treat the remote start fob as you would any other admin key. When the vehicle is started using remote start, the system will stall the engine when you either enter the vehicle or shift the vehicle into gear. Prior to the engine stall, the vehicle will have administrative privileges. When you restart the engine, the vehicle will identify the user as an admin or MyKey™ drive depending on the settings of the actual key used to start the vehicle.

Note: For all vehicles, the number of MYKEY(S) PROGRAMMED or ADMIN KEYS PROGRAMMED that is displayed in the MyKey™ system status menus will include the non Ford-approved remote start system as an additional key in the total count. See the *Check MyKey™ system status* section.

Note: For all vehicles with a non Ford-approved remote start installed, it is possible to program all 'real' keys as MyKeys™, in which case, you will need to use your remote start system to reset all MyKeys™ as admin keys by doing the following:

1. Enter the vehicle, close all doors.
2. Remote start the vehicle using your non Ford-approved remote start fob.
3. Follow Steps 1-4 in the *Clear MyKey™* section.

Locks and Security

Troubleshooting



| Condition | Potential Causes |
|---|---|
| Can't create a MyKey™ | <ul style="list-style-type: none"> • Key in backup slot is the last remaining admin key (there always has to be at least one admin key). • Key in backup slot is a MyKey™. • Key is not in the backup slot. • SecuriLock® passive anti-theft system is disabled or in unlimited mode. • Vehicle has been started using a non Ford-approved remote start system that is programmed as MyKey™. Refer to <i>Using MyKey™ with remote start systems</i> section. |
| Cannot program the MyKey™ optional settings | <ul style="list-style-type: none"> • Key in backup slot is a MyKey™. • No MyKeys™ are programmed to the vehicle. Refer to <i>Create a MyKey™</i> section. • Vehicle has been started using a non Ford-approved remote start system that is programmed as MyKey™. Refer to <i>Using MyKey™ with remote start systems</i> section. |
| Cannot clear MyKey™ | <ul style="list-style-type: none"> • No MyKeys™ are programmed to the vehicle. Refer to <i>Create a MyKey™</i> section. • Vehicle has been started using a non Ford-approved remote start system that is programmed as MyKey™. Refer to <i>Using MyKey™ with remote start systems</i> section. |
| Lost the only admin key | <ul style="list-style-type: none"> • Purchase a new key from your authorized dealer. |
| Lost any key | <ul style="list-style-type: none"> • For programming spare keys, refer to the <i>Programming spare keys</i> section in this chapter. |

Locks and Security

| Condition | Potential Causes |
|---|--|
| I accidentally programmed all keys as MyKeys™ | <ul style="list-style-type: none"> • Vehicle has a non Ford-approved remote start system that is recognized as an admin key. Refer to the <i>Using MyKey™ with remote start systems</i> section to reset all MyKeys™ as admin keys. |
| No MyKey™ function | <ul style="list-style-type: none"> • An admin intelligent access key is present. • No MyKeys™ are programmed to the vehicle. Refer to <i>Create a MyKey™</i> section. • Vehicle has been started using a non Ford-approved remote start system (as an admin key) then a MyKey™ is inserted without restarting the engine. |
| MyKey™ programmed total includes one additional key | <ul style="list-style-type: none"> • Unknown key has been programmed to the vehicle as a MyKey™. • Vehicle is equipped with a non Ford-approved remote start system. Refer to <i>Using MyKey™ with remote start systems</i> section. |
| Admin keys programmed total includes one additional key | <ul style="list-style-type: none"> • Unknown key has been programmed to the vehicle as admin key. • Vehicle is equipped with a non Ford-approved remote start system. Refer to <i>Using MyKey™ with remote start systems</i> section. |
| MyKey™ distance does not accumulate | <ul style="list-style-type: none"> • MyKey™ is not being used by the intended user. • MyKey™ system has been recently cleared. • Vehicles has been remote started using a non Ford-approved remote start system (as if an admin key) then a MyKey™ is inserted without recycling the MyKey™ in ignition. |

Locks and Security

POWER DOOR LOCKS

- Press the  control to unlock all doors.
- Press the  control to lock all doors.

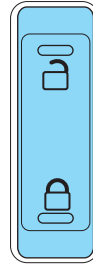

Smart unlocks

The smart unlock feature is intended to prevent you from unintentionally locking your IA key inside your vehicle's passenger compartment or rear cargo area.

When you lock your vehicle using the driver or passenger power door lock control (with the door open, vehicle in park and ignition off), after you close the door the vehicle will search for an IA key in the passenger compartment. If an IA key is found inside the vehicle, all of the doors will immediately unlock and the horn will chirp, indicating that the IA key is inside.

In order to override the smart unlock feature and intentionally lock the IA key inside the vehicle, you can lock your vehicle using your keyless entry keypad or using the  control on another IA key. Refer to *Keyless entry system* in this chapter for more information on keyless entry keypad operation.

If your vehicle's perimeter alarm is in the armed state, the smart unlock feature will not allow you to lock your IA key inside the vehicle. When the alarm is armed, if the IA key is detected in the vehicle, the liftgate will automatically be released, and the horn will chirp, as a reminder that the IA key is inside. If you would like to intentionally lock your IA key in your vehicle, first disarm the perimeter alarm by unlocking the vehicle, then place the IA key in the rear cargo area, close the liftgate, and rearm your perimeter alarm system by locking the vehicle using your keyless entry keypad or another IA key. For more information on arming/disarming of the perimeter alarm system, refer to *Perimeter alarm system* in this chapter.

Locks and Security

Autolock feature

The autolock feature will lock all the doors when:

- all the doors are closed,
- the ignition on,
- you shift into any gear putting the vehicle in motion, and
- the vehicle attains a speed greater than 12 mph (20 km/h).

The autolock feature repeats when:

- any door is opened then closed while the ignition is on and the vehicle speed is 9 mph (15 km/h) or lower, and
- the vehicle then attains a speed greater than 12 mph (20 km/h).

Deactivating/activating autolock feature

Your vehicle comes with the autolock features activated; there are four methods to enable/disable this feature:

- Through your authorized dealer,
- by using a power door unlock/lock procedure,
- using a keypad procedure, or
- or by using the instrument cluster message center. Refer to *Message center* in the *Instrument Cluster* chapter.

Note: The autolock feature can be activated/deactivated independently of the autounlock feature.

Power door lock switch autolock enable/disable procedure

Before starting, ensure the ignition is off and all vehicle doors are closed. You must complete Steps 1–5 within 30 seconds or the procedure will have to be repeated. If the procedure needs to be repeated, wait a minimum of 30 seconds before beginning again.

Locks and Security

1. Turn the ignition on.
2. Press the power door unlock control on the door panel three times.
3. Turn the ignition off.
4. Press the power door unlock control on the door panel three times.
5. Turn the ignition back on. The horn will chirp one time to confirm programming mode has been entered and is active.
6. To enable/disable the autolock feature, press the unlock control, then press the lock control. The horn will chirp once if autolock was deactivated or twice (one short and one long chirp) if autolock was activated.
7. Turn the ignition off. The horn will chirp once to confirm the procedure is complete.

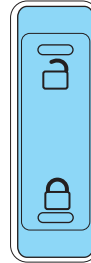

Keyless entry keypad autolock enable/disable procedure

1. Turn the ignition off.
2. Close all the doors.
3. Enter factory-set 5-digit entry code.
4. Press and hold the 3 • 4. While holding the 3 • 4 press the 7 • 8.
5. Release the 7 • 8.
6. Release the 3 • 4.

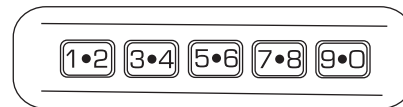

The user should receive a **horn chirp** to indicate the system has been disabled or a chirp followed by a honk to indicate the system has been enabled.

Autounlock feature

The autounlock feature will unlock all the doors when:

- the ignition is on, all the doors are closed, and the vehicle has been in motion at a speed greater than 12 mph (20 km/h);
- the vehicle has then come to a stop and the ignition is turned off or to accessory; and
- the driver door is opened within 10 minutes of the ignition being turned off or to accessory.

Locks and Security

Note: The doors will not autounlock if the vehicle has been electronically locked before the driver door is opened.

Deactivating/activating autounlock feature

Your vehicle comes with the autounlock features activated; there are four methods to enable/disable this feature:

- Through your authorized dealer,
- by using a power door unlock/lock sequence,
- using a keypad procedure, or
- or by using the instrument cluster message center. Refer to *Message center* in the *Instrument Cluster* chapter.

Note: The autounlock feature can be activated/deactivated independently of the autolock feature.

Power door lock switch autounlock enable/disable procedure

Before starting, ensure the ignition is off and all vehicle doors are closed. You must complete Steps 1–5 within 30 seconds or the procedure will have to be repeated. If the procedure needs to be repeated, wait a minimum of 30 seconds before beginning again.

1. Turn the ignition on.
2. Press the power door unlock control on the door panel three times.
3. Turn the ignition off.
4. Press the power door unlock control on the door panel three times.
5. Turn the ignition back on. The horn will chirp one time to confirm programming mode has been entered and is active.
6. To enable/disable the autounlock feature, press the lock control, then press the unlock control. The horn will chirp once if autounlock was deactivated or twice (one short and one long chirp) if autounlock was activated.
7. Turn the ignition off. The horn will chirp once to confirm the procedure is complete.

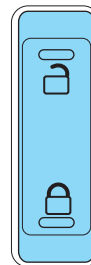

100

Locks and Security

Keyless entry keypad autounlock enable/disable procedure

1. Turn the ignition off.
2. Close all the doors.
3. Enter factory-set 5-digit entry code.
4. Press and hold the 3 • 4. While holding the 3 • 4, press and release the 7 • 8. While still holding the 3 • 4, press and release the 7 • 8 a second time.
5. Release the 3 • 4.



The user should receive a **horn chirp** to indicate the system has been disabled or a chirp followed by a honk to indicate the system has been enabled.

CHILDPROOF DOOR LOCKS

- When these locks are set, the rear doors cannot be opened from the inside.
- The rear doors can be opened from the outside when the childproof door locks are set, but the doors are unlocked.

The childproof locks are located on the rear edge of each rear door and must be set separately for each door. Setting the lock for one door will not automatically set the lock for both doors.

- Insert the key and turn to the lock position (key horizontal) to engage the childproof locks.
- Insert the key and turn to the unlock position (key vertical) to disengage the childproof locks.

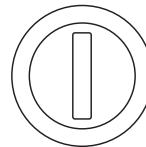
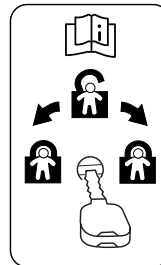

REMOTE ENTRY SYSTEM

The intelligent access keys (IA key) comply with part 15 of the FCC rules and with RSS-210 of Industry Canada. Operation is subject to the following two conditions: (1) This device may not cause harmful interference, and (2) This device must accept any interference received, including interference that may cause undesired operation.

101





Locks and Security

Changes or modifications not expressly approved by the party responsible for compliance could void the user's authority to operate the equipment.

The typical operating range for your transmitter is approximately 33 feet (10 meters). A decrease in operating range could be caused by:

- weather conditions,
- nearby radio towers,
- structures around the vehicle, or
- other vehicles parked next to your vehicle.

The transmitter allows you to:

- remotely unlock the vehicle doors .
- remotely lock all the vehicle doors .
- remotely open the power liftgate .
- remotely start the vehicle .
- activate the personal alarm .
- arm and disarm the perimeter anti-theft system.
- operate the illuminated entry feature.
- activate the global opening windows feature.

Refer to *Intelligent access* in this section for more features.

The remote entry lock/unlock feature operates in any ignition position except while the vehicle is in the start position. The panic feature operates with the ignition off.

If there are problems with the remote entry system, make sure to take **ALL intelligent access keys** with you to the authorized dealer in order to aid in troubleshooting the problem.

Intelligent access



WARNING: Radio waves from the intelligent access system transmitters in the vehicle may affect certain implanted medical devices such as pacemakers or cardiac defibrillators. People having such implanted medical devices should ask the medical device manufacturer or their physician whether the intelligent access system may affect the equipment before coming into close proximity with a vehicle equipped with intelligent access. Failure to do so may result in interference with the medical device, which could result in serious injury.

Locks and Security

Your intelligent access system uses a radio frequency (RF) signal to communicate with your vehicle and authorize your vehicle to unlock when commanded (either by touching the inside of the driver or front passenger exterior door handle, the power liftgate button, or a button on the transmitter itself). If excessive RF interference is present in the area, or if your vehicle battery is low, it may be necessary to mechanically unlock your door. The mechanical key blade in your IA key can be used to open the driver's door in this situation (refer to *Intelligent access key* in this chapter for more information on the location and use of the mechanical key blade).

Your vehicle will allow you to unlock and enter your vehicle without actively using a key or transmitter. You can use the intelligent access feature at the front doors or at the liftgate. You can activate the intelligent access feature as long as you have one of your IA keys within range of the front doors or the liftgate.

Activating intelligent access at the front doors: If your IA key is within 3 feet (1 meter) of the front doors you can activate your intelligent access system by touching the inside of the driver or front passenger exterior door handle. The door(s) will automatically unlock and the door can be opened.

To lock the doors, press the lock area on either door handle (black button on chrome handled doors or the small bump on painted door handles).

Activating intelligent access at the liftgate: If your IA key is within 3 feet (1 meter) of the liftgate, you can activate your intelligent access system by pressing the exterior liftgate release button, hidden under the trim above the license plate. The liftgate will release and open.

Push button start: The push button start system allows you to start your vehicle without using a key. Refer to *Push button start* in the *Driving* chapter.

Unlocking the doors/two stage unlock

1. Press  and release to unlock the driver's door.



Note: The interior lamps and parking lamps will illuminate.

2. Press  and release again within three seconds to unlock all the doors.

The remote entry system activates the illuminated entry feature; this feature turns on the lamps for 25 seconds or until the ignition is turned on.



Locks and Security

The battery saver feature will turn off the lamps 10 minutes after the ignition is turned off.

Two stage unlocking may be disabled or re-enabled by simultaneously pressing the  and  controls on the transmitter for four seconds (disabling two stage unlock allows all vehicle doors to unlock simultaneously). The parking lamps will illuminate twice to indicate that two-stage unlock was enabled or disabled.

If equipped with IA key, when two stage unlocking is disabled, intelligent access at the driver's door results in an unlock of all doors (not just the driver door).

Locking the doors

1. Press  and release to lock all the doors. The parking lamps will illuminate.
2. Press  and release again within three seconds to confirm that all the doors are closed. **Note:** The doors will lock again, the horn will chirp and the turn lamps will illuminate if all the doors and liftgate are closed.

Note: If any door or the liftgate is not closed, the horn will chirp twice and the lamps will not flash.

Car finder

Press  twice within three seconds. The horn will chirp and the turn lamps will flash. It is recommended that this method be used to locate your vehicle, rather than using the panic alarm.

Sounding a panic alarm

Press  to activate the alarm. Press again or turn the ignition to on to deactivate.

Note: The panic alarm will only operate when the ignition is off.

Opening the power liftgate

Press  twice within three seconds to fully unlatch and open the liftgate.



WARNING: Make sure all persons are clear of the liftgate area before using power liftgate control.

In order to fully lower and latch the liftgate, press the control twice.

104

Locks and Security

If the liftgate stops mid-travel, it may have detected an obstacle. Check to ensure the liftgate swing zone is free from obstruction and reset the power assist by manually closing the liftgate. Normal operation can then be resumed.



WARNING: Make sure the liftgate is closed to prevent exhaust fumes from being drawn into the vehicle. This will also prevent passengers and cargo from falling out. If you must drive with the liftgate open, keep the vents open so outside air comes into the vehicle.

Memory feature (seat, mirrors and steering column)

The intelligent access key (IA key) allows you to recall the memory seat/power mirrors/steering column feature.

Press  to automatically move the seat, power mirrors and steering column to the desired memory position. The mirrors will move to the programmed position and the seat will move to the easy entry position. The seat will move to the final position when the ignition is switched out of off (if easy entry feature is enabled).

Programming the memory feature to the transmitter

To activate this feature:

1. Move the driver seat, power mirrors and steering column to the desired positions using the associated controls.

2. Press and hold button 1 for five seconds. A tone will be heard after about two seconds confirming memory position has been set. Continue to hold until a second tone is heard after five seconds.

3. Within three seconds press .

4. Press .

5. Repeat this procedure for memory 2 and another transmitter if desired.

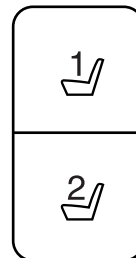

Deprogramming the memory feature from the transmitter

To deactivate this feature:

1. Press and hold either the 1 or 2 button for five seconds. A tone will be heard after 1½ seconds when the memory store is done, continue to hold until a second tone is heard after five seconds.

105

Locks and Security

2. Within three seconds press the .
3. Repeat this procedure for transmitter if desired.

Memory profiles

The memory feature also coordinates with user-created profile settings utilizing the infotainment touchscreen system (if equipped). See the *Creating a user profile* section in the *MyLincoln Touch*™ supplement for more information.

Replacing the battery

The intelligent access key (IA key) uses one coin type three-volt lithium battery CR2032 or equivalent.

To replace the battery:

1. Remove the backup key from the transmitter, then twist a thin coin in the slot hidden behind the backup key slot to remove the battery cover.

Note: Do not wipe off any grease on the battery terminals or on the back surface of the circuit board.

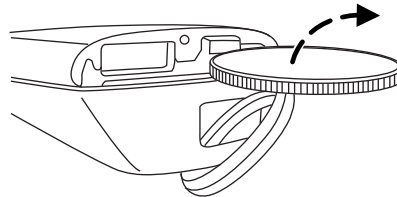

2. Remove the old battery.

Note: Please refer to local regulations when disposing of transmitter batteries.

3. Insert the new battery. Refer to the instructions inside the IA key for the correct orientation of the battery. Press the battery down to ensure that the battery is fully seated in the battery housing cavity.

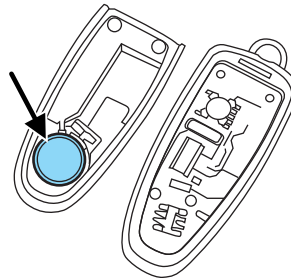

4. Snap the battery cover back onto the transmitter and install the backup key.

Note: Replacement of the battery will **not** cause the IKT or IA key to become de-programmed from your vehicle. They should operate normally after battery replacement.

106

Locks and Security

Replacing lost intelligent access keys (IA keys)

If you would like to have your IA keys reprogrammed because you lost one, or would like to buy additional transmitters you can either reprogram them yourself, or take **all transmitters** to your authorized dealer for reprogramming.

How to reprogram your intelligent access keys (IA keys)

To program new IA keys yourself, refer to *SecuriLock® passive anti-theft system* in this chapter. **Note:** At least two already programmed transmitters are required to perform this procedure yourself.

Illuminated entry

The interior lamps, parking lamps and puddle lamps (if equipped) illuminate when the IA key or the keyless entry keypad is used to unlock the door(s).

The illuminated entry system will turn off the lights if:

- the ignition is turned on, or
- the  control on the transmitter is pressed, or
- the vehicle is locked using the keyless entry keypad, or
- the vehicle is locked using the key in the driver door cylinder, or
- after 25 seconds of illumination.

The lights will not turn off if:

- they have been turned on with the dimmer control, or
- any door is open.

Illuminated exit

When all vehicle doors are closed and the ignition is turned off, the interior dome lamps, parking lamps and puddle lamps (if equipped) will illuminate.

The lights will turn off if all the doors remain closed and

- 25 seconds elapse, or
- the start button is pressed.

Battery saver

The battery saver will shut off the lamps 10 minutes after the ignition has been turned off.

Locks and Security

- If the dome lamps were turned on using the panel dimmer control, the battery saver will shut them off 10 minutes after the ignition has been turned off.
- If the courtesy lamps were turned on because one of the vehicle doors or the trunk was opened, the battery saver will shut them off 10 minutes after the ignition has been turned off.
- The battery saver will shut off the headlamps 10 minutes after the ignition has been turned off.

Accessory mode battery saver for intelligent access keys with push button start

The battery saver will shut off the ignition approximately 45 minutes after the vehicle is left in accessory mode, in order to preserve the vehicle's battery.

Remote start

The remote start feature allows you to start the engine from outside the vehicle. If your transmitter has a  icon, you have remote start. The remote start feature has an extended operating range which allows you to remote start your vehicle from a farther distance from your vehicle. All the buttons have this increased range performance capability when equipped with remote start.

Vehicles with automatic climate control can be configured to operate when the vehicle is started. Refer to *Remote start climate options* in the *Climate Controls* chapter for more information and also refer to *Message center* in the *Instrument Cluster* chapter to learn how to enable different climate options. A manual climate control system will run at the setting it was set to when the vehicle was last turned off.

To help make the vehicle as comfortable as possible, the engine idle can be increased during a remote start. You can enable or disable engine idle increase by selecting Remote Start Quiet in the message center. Refer to *Message center* in the *Instrument Cluster* chapter.

Many states and provinces have restrictions for the use of remote start. Check your local and state or provincial laws for specific requirements regarding remote start systems.

Note: Do not use remote start if your vehicle is low on fuel.



WARNING: To avoid exhaust fumes, do not use remote start if your vehicle is parked indoors or areas that are not well ventilated.

Locks and Security



The remote start system will not work if:

- The ignition is on.
- The alarm system is triggered.
- The feature has been disabled.
- The hood is not closed.
- Two remote vehicle starts have already been attempted within the last hour.
- The vehicle is not in P (Park).

Starting the engine with remote start

The remote start label on your transmitter details the engine starting procedure. To start the engine using remote start:

Note: Each button press must be done within three seconds of each other. If this sequence is not followed, the vehicle will not remote start and the horn will not chirp.

1. Press  to lock all the doors.
2. Press  two times. The exterior lamps will flash twice.

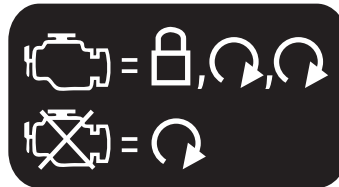

If for some reason, the system fails to start, the horn will chirp.

Note: You must press the START/STOP button on the instrument panel once while applying the brake pedal before driving the vehicle.

The power windows will be inhibited during the remote start and the radio will not turn on.

The parking lamps will remain on and the engine will run for 5, 10, or 15 minutes, depending on how you programmed the system. To select the duration of the remote start system refer to *Message center* in the *Instrument Cluster* chapter.

Extending the engine run time

To keep the engine running for another remote start duration, repeat Steps 1 and 2 with the engine still running. If you programmed the duration to last 10 minutes, the second 10 minutes will begin immediately so that, for example, if the vehicle had been running from the first remote start for five minutes, the engine will continue to run for a total of 15 minutes. You can only extend the remote start once.

109

Locks and Security

The ignition must be turned on and then back off or allow one hour to pass before using remote start again.

Turning the engine off after using remote start

- Press **(2x)** one time. The parking lamps will turn off.

You may have to be closer to the vehicle than when starting due to ground reflection and the added noise of the running engine.

You can disable or enable the remote start system through the message center. Refer to *Message center* in the *Instrument Cluster* chapter.

SECURICODE™ KEYLESS ENTRY SYSTEM

You can use the keyless entry keypad to:

- lock or unlock the doors without using a key.
- recall memory seat/power mirrors positions.

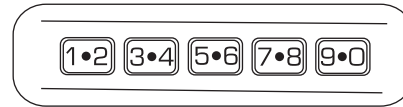

The keypad can be operated with the factory set 5–digit entry code; this code is located on the owner’s wallet card in the glove box and is available from your authorized dealer. You can also create up to three of your own 5–digit personal entry codes.

When pressing the controls on the keypad, press the middle of the controls to ensure a good activation.

Programming a personal entry code and keypad association to memory feature

To create your own personal entry code:

1. Enter the factory set code.
2. Within five seconds press the 1 • 2 on the keypad.
3. Enter your personal 5-digit code. Each number must be entered within five seconds of each other.
4. For memory recall feature, enter the sixth digit 1 • 2 to store driver 1 settings or 3 • 4 to store driver 2 settings.

Note: Pressing 5 • 6, 7 • 8, or 9 • 0 keypad numbers as a sixth digit will not recall a driver memory setting.

Note: The factory-set code cannot be associated with a memory setting.

5. The doors will lock then unlock to confirm that your personal entry code has been programmed to the module.

110

Locks and Security

Tips:

- Do not set a code that uses five of the same number.
- Do not use five numbers in sequential order.
- The factory set code will work even if you have set your own personal code.

Erasing personal code

1. Enter the factory set 5–digit code.
2. Within five seconds, press the 1 • 2 on the keypad and release.
3. Press and hold the 1 • 2 for two seconds. This must be done within five seconds of completing Step 2.

All personal codes are now erased and only the factory set 5–digit code will work.

Anti-scan feature

If the wrong code has been entered seven times (35 consecutive button presses), the keypad will go into an anti-scan mode. This mode disables the keypad for one minute and the keypad lamp will flash.

The anti-scan feature will turn off after:

- one minute of keypad inactivity.
- pressing the  control on the remote entry transmitter portion of your integrated keyhead transmitter.
- the ignition is turned on.

Unlocking and locking the doors using keyless entry

To unlock the driver's door, enter the factory set 5-digit code or your personal code. Each number must be pressed within five seconds of each other. The interior lamps will illuminate. **Note:** If the two-stage unlocking feature is disabled, all doors will unlock; for more information regarding two-stage unlocking, refer to the *Unlocking the doors/Two stage unlock* section earlier in this chapter.

To unlock all doors, enter the factory set code or your personal code, then press the 3 • 4 control within five seconds.

To lock all doors, press and hold the 7 • 8 and the 9 • 0 at the same time (with the driver's door closed). You **do not** need to enter the keypad code first.

Locks and Security

SECURILOCK® PASSIVE ANTI-THEFT SYSTEM

SecuriLock® passive anti-theft system is an engine immobilization system. This system is designed to help prevent the engine from being started unless an **intelligent access key programmed to your vehicle** is used. The use of the wrong type of coded key may lead to a “no-start” condition. The message center will display: **STARTING SYSTEM FAULT**.

Your vehicle comes with two intelligent access keys; additional units may be purchased from your authorized dealer. The authorized dealer can program these to your vehicle or you can program them yourself. Refer to *Programming spare intelligent access keys* for instructions on how to program the coded key.

Note: The SecuriLock® passive anti-theft system is not compatible with non-Ford aftermarket remote start systems. Use of these systems may result in vehicle starting problems and a loss of security protection.

Note: Large metallic objects, electronic devices that are used to purchase gasoline or similar items, or a second coded key on the same key chain may cause vehicle starting issues. You need to prevent these objects from touching the coded key while starting the engine. These objects will not cause damage to the coded key, but may cause a momentary issue if they are too close to the key when starting the engine. If a problem occurs, turn the ignition off, remove all objects on the key chain away from the coded key and restart the engine.

Note: Do not leave a duplicate coded key in the vehicle. Always take your keys and lock all doors when leaving the vehicle.

Automatic arming

The vehicle is armed immediately after turning the ignition off.

Automatic disarming

Switching the ignition on with a **coded key** disarms the vehicle.

Replacement of intelligent access keys

Note: Your vehicle comes equipped with two intelligent access keys.

The intelligent access key functions as both a programmed key that operates the driver door lock, activates intelligent access with push button start systems as well as a remote keyless entry transmitter. A maximum of four intelligent access keys can be programmed to your vehicle.

112

Locks and Security

If your intelligent access key are lost or stolen and you don't have an extra key, you will need to have your vehicle towed to an authorized dealer. The key codes need to be erased from your vehicle and new keys will need to be programmed.

Replacing intelligent access keys can be very costly. Store an extra programmed key away from the vehicle in a safe place to help prevent any inconveniences. Please visit an authorized dealer to purchase additional spare or replacement keys.

Programming spare intelligent access keys

You must have two previously programmed intelligent access keys inside the vehicle and the new unprogrammed intelligent access keys readily accessible. If two previously programmed keys are not available, you must take your vehicle to your authorized dealer to have the spare key(s) programmed.

Note: A maximum of four intelligent access keys can be programmed to your vehicle. If you would like to replace a previously programmed access key with a new access key, or if you already have four access keys programmed to your vehicle, you must take your vehicle and all access keys to your authorized dealer to be erased and reprogrammed.

Ensure that the vehicle is off before beginning this procedure. Ensure that all doors are closed before beginning this procedure and that all doors remain closed throughout the procedure. Perform this procedure exactly as described below, and perform all steps within 30 seconds of starting the sequence. If any steps are performed out of sequence, stop and wait for at least one minute before starting again.



Please read and understand the entire procedure before you begin.

1. Place the new unprogrammed intelligent access key in the pocket inside the center console utility compartment.
2. Press the driver or passenger power door unlock control three times.
3. Press and release the brake pedal one time.
4. Press the driver or passenger power door lock control three times.
5. Press and release the brake pedal one time. The indicator on the Start/Stop button should begin to rapidly flash, indicating that programming mode has been entered and two programmed intelligent access keys have been detected in the vehicle.
6. Within one minute, press the start/stop button. A message will be displayed on the message center indicating that the new intelligent access key was programmed. If four intelligent access keys have already

113

Locks and Security

been programmed to your vehicle, you cannot program anymore and the message MAX # OF KEYS LEARNED will be displayed on the message center.

7. Remove intelligent access key from utility compartment pocket and press the  or  control on the newly programmed intelligent access keys to exit programming mode.

8. Verify that the remote entry functions operate (lock, unlock) and that the vehicle starts with new intelligent access key.

If the intelligent access key has been successfully programmed, it can be used to activate the Intelligent Access with Push Button Start feature and can be used to start your vehicle.

Note: To program MyKey™ features, refer to *MyKey™* in this chapter.

PERIMETER ALARM SYSTEM

The perimeter alarm system will help protect your vehicle from unauthorized entry.

When the following types of unauthorized entry occur:

- any door, the hood or the liftgate/trunk is opened without using the keypad or the remote entry transmitter,
- or if the ignition is turned on when using an invalid key,

the perimeter alarm will flash the turn signal lamps and sound the horn.

ARMING THE SYSTEM

The system is ready to arm whenever the ignition is off. To arm the system, do one of the following:

- Press the  control on the remote entry transmitter.

Note: If you press the  control twice on the remote entry transmitter within three seconds, the horn will chirp **once** to let you know that all doors, the hood and the liftgate/trunk are closed. If any of these are not closed, the horn will chirp **twice** to warn you that they are still open.

- Press the driver or passenger interior door lock control  while the door is open, then close the door.
- Lock the doors using the intelligent access method (press the lock area in either front door handle).
- Press and hold the 7 • 8 and 9 • 0 controls together on the keyless entry pad to lock the doors (driver's door must be closed).

114

Locks and Security



After locking the doors using any of the methods above, the turn signal lamps will flash once indicating that the perimeter alarm is in the pre-armed mode and will become fully armed in 20 seconds.

Note: Pressing the power door unlock control within the 20-second, pre-armed mode will disarm the system.

When fully armed (after the 20 second pre-arm mode), any IA keys found inside the vehicle are disabled/inoperable and will not start the engine. Press  button to re-enable them.

Disarming the system

To disarm the system, do any of the following:

- Unlock the doors by pressing unlock  on the remote entry transmitter.
- Unlock the doors by using your keyless entry pad.
- Enter the vehicle using intelligent access.
- Press the panic control  on the remote entry transmitter. The alarm system will still be armed, but this shuts off the horn and turn lamps when the alarm is sounding.
- Unlock the doors using a key. If you use this method the system will not disarm, but you will have an opportunity to disarm the vehicle once entered. See the Note following.

Note: If the driver's door is unlocked with a key, a chime will sound when you open the door and the message center will display **TO STOP ALARM START VEHICLE**. When this occurs, you will have 12 seconds to disarm the alarm using any of the actions above, otherwise the alarm will trigger.

Perimeter alarm issues

If there seems to be a potential perimeter alarm system problem with your vehicle, ensure **ALL** keys/remote entry transmitters are brought to your authorized dealer to aid in troubleshooting.

Seating and Safety Restraints

FRONT SEATING

! **WARNING:** Reclining the seatback can cause an occupant to slide under the seat's safety belt, resulting in severe personal injuries in the event of a collision.

! **WARNING:** Do not pile cargo higher than the seatbacks to reduce the risk of injury in a collision or sudden stop.

! **WARNING:** Before returning the seatback to its original position, make sure that cargo or any objects are not trapped behind the seatback. After returning the seatback to its original position, pull on the seatback to ensure that it has fully latched. An unlatched seat may become dangerous in the event of a sudden stop or collision.

Adjustable head restraints

Your vehicle is equipped with front row outboard head restraints that are vertically adjustable.

! **WARNING:** To minimize the risk of neck injury in the event of a crash, the driver and passenger occupants should not sit in and/or operate the vehicle, until the head restraint is placed in its proper position. The driver should never adjust the head restraint while the vehicle is in motion.

The adjustable head restraints consist of:

- a trimmed energy absorbing foam and structure (1),
- two steel stems (2),
- a guide sleeve adjust/release button (3),
- and a guide sleeve unlock/remove button (4).

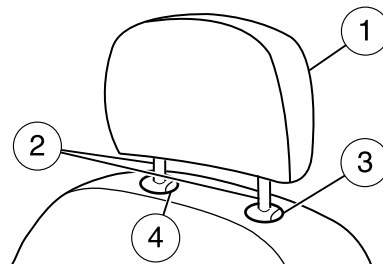

Seating and Safety Restraints

To adjust the head restraint, do the following:

1. Adjust the seatback to an upright driving/riding position.
2. Raise the head restraint by pulling up on the head restraint.

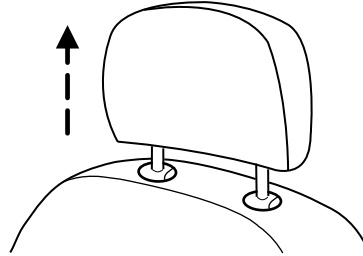

3. Lower the head restraint by pressing and holding the guide sleeve adjust/release button and pushing down on the head restraint.

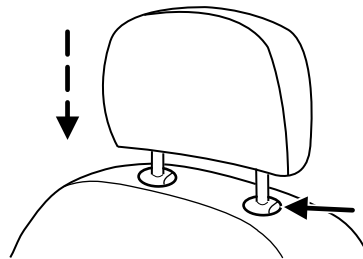

Properly adjust the head restraint so that the top of the head restraint is even with the top of your head and positioned as close as possible to the back of your head. For occupants of extremely tall stature, adjust the head restraint to its full up position.



WARNING: The adjustable head restraint is a safety device. Whenever possible it should be installed and properly adjusted when the seat is occupied.

Seating and Safety Restraints

To remove the adjustable head restraint, do the following:

1. Pull up the head restraint until it reaches the highest adjustment position.

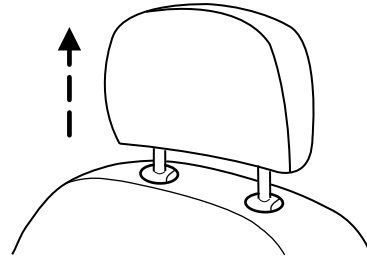

2. Simultaneously press and hold both the adjust/release button and the unlock/remove button, then pull up on the head restraint.

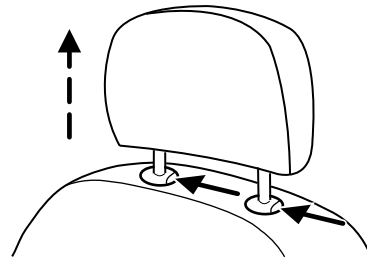

To reinstall the adjustable head restraint, do the following:

1. Insert the two stems into the guide sleeve collars.
2. Push the head restraint down until it locks.

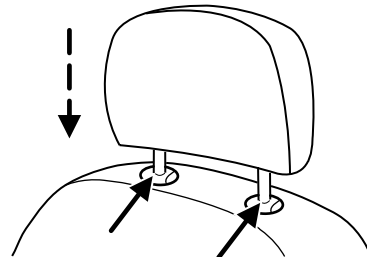

Properly adjust the head restraint so that the top of the head restraint is even with the top of your head and positioned as close as possible to the back of your head. For occupants of extremely tall stature, adjust the head restraint to its full up position.

Seating and Safety Restraints



WARNING: To minimize the risk of neck injury in the event of a crash, head restraints must be installed properly.

Adjusting the front power seat



WARNING: Never adjust the driver's seat or seatback when the vehicle is moving.



WARNING: Do not pile cargo higher than the seatbacks to reduce the risk of injury in a collision or sudden stop.



WARNING: Always drive and ride with your seatback upright and the lap belt snug and low across the hips.



WARNING: Reclining the seatback can cause an occupant to slide under the seat's safety belt, resulting in severe personal injuries in the event of a collision.



WARNING: Sitting improperly out of position or with the seat back reclined too far can take off weight from the seat cushion and affect the decision of the front passenger sensing system, resulting in serious injury or death in a crash. Always sit upright against your seatback, with your feet on the floor.



WARNING: To reduce the risk of possible serious injury: Do not hang objects off seat back or stow objects in the seatback map pocket (if equipped) when a child is in the front passenger seat. Do not place objects underneath the front passenger seat or between the seat and the center console (if equipped). Check the "passenger airbag off" or "pass airbag off" indicator lamp for proper airbag status. Refer to *Front passenger sensing system* in the *Airbag supplemental restraint system (SRS)* section for additional details. Failure to follow these instructions may interfere with the front passenger seat sensing system.

The control is located on the outboard side of the seat cushion.

119

Seating and Safety Restraints

Press the front or rear portion to tilt the seat.

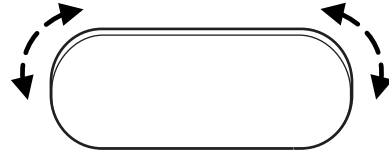

Press the control to move the seat forward, backward, up or down.

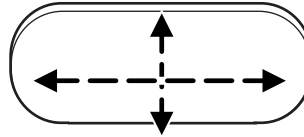

Move the switch to recline the seatback forward or rearward.

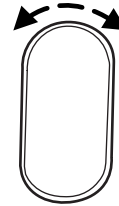

Using the power lumbar support

The power lumbar control is located on the outboard side of the seat.

Press one side of the control to adjust firmness.

Press the other side of the control to adjust softness.

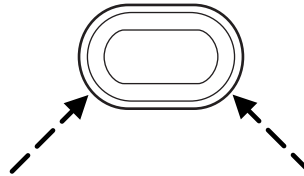

Seating and Safety Restraints

Heated and cooled seats

Heated seats

 **WARNING:** Persons who are unable to feel pain to the skin because of advanced age, chronic illness, diabetes, spinal cord injury, medication, alcohol use, exhaustion, or other physical conditions, must exercise care when using the seat heater. The seat heater may cause burns even at low temperatures, especially if used for long periods of time. Do not place anything on the seat that insulates against heat, such as a blanket or cushion, because this may cause the seat heater to overheat. Do not puncture the seat with pins, needles, or other pointed objects because this may damage the heating element which may cause the seat heater to overheat. An overheated seat may cause serious personal injury.

Note: Do not do the following:

- Place heavy objects on the seat
- Operate the seat heater if water or any other liquid is spilled on the seat. Allow the seat to dry thoroughly.

The heated seats will only function when the engine is running.

To operate the heated seats:

Press the heated seat symbol to cycle through the various heat settings and off. Warmer settings are indicated by more indicator lights.



The heated seats will turn off after 15 minutes.

If the engine falls below 350 RPMs while the heated seats are on, the feature will turn itself off and will need to be reactivated.

Cooled seats

The cooled seats will only function when the engine is running.

To operate the cooled seats:

Press the cooled seat symbol to cycle through the various cooling settings and off. Cooler settings are indicated by more indicator lights.



The cooled seats will turn off after 30 minutes.

Seating and Safety Restraints

If the engine falls below 350 RPMs while the cooled seats are on, the feature will turn itself off and will need to be reactivated.

Climate controlled seats air filter replacement

The climate controlled seat system includes air filters that must be replaced periodically. Refer to the *scheduled maintenance information* for more information.

- There is a filter located under each front seat.

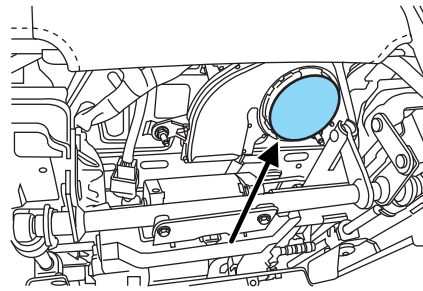

- The filter can be accessed from the 2nd row foot-well area. Move the front seats all the way to the full front and full up positions to ease access.

To remove an air filter:

1. Turn the vehicle off.
2. Push up on the outside rigid edge of the filter until the tabs are released, then rotate the air filter toward the front of the vehicle.

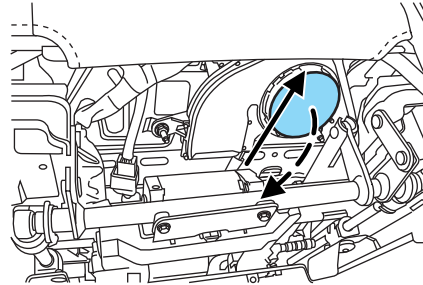

3. Remove filter.

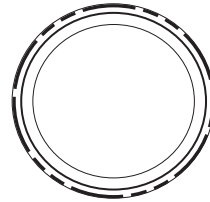

Seating and Safety Restraints

To install a filter:

1. First, position the filter in its housing making sure that the far forward end is all the way up in the housing.
2. Push in on the center of the outside edge of the filter and rotate up into the housing until it clips into position.

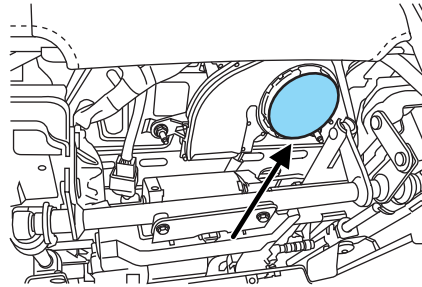

Memory feature

This system allows automatic positioning of the driver seat, power mirrors and power tilt/telescopic steering column (if equipped) to two programmable positions.

The memory seat control is located on the instrument panel.

- To program position 1, move the appropriate features to the desired position using the associated controls. Press and hold button 1 for at least two seconds. A chime will sound confirming that a memory position has been set.
- To program position 2, repeat the previous procedure using button 2.

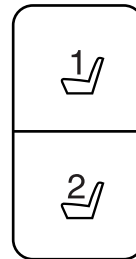

A memory position may be programmed at any time.

To program the memory feature to a remote entry transmitter, refer to *Remote entry system* in the *Locks and Security* chapter.

A programmed memory position can be recalled:

- in any gearshift position if the ignition is **not** on.
- only in P (Park) or N (Neutral) if the ignition is on.

The memory positions are also recalled when you press your remote entry transmitter  (unlock) control (if the transmitter is programmed to a memory position) or, when you enter a valid personal entry code that is programmed to a memory position. The mirrors will move to the programmed position and the seat will move to the easy entry position. The seat will move to the final position when the key is in the ignition (if easy entry feature is enabled).

Seating and Safety Restraints

Memory profiles

The memory feature also coordinates with user-created profile settings utilizing the infotainment touchscreen system. See the *Creating a user profile* section in the *MyLincoln Touch*[™] supplement for more information.

Easy entry/exit feature

This feature automatically moves the steering wheel all the way up and in and moves the driver's seat rearward 2 in. (5 cm) when:

- the transmission is in N (Neutral) or P (Park)
- the ignition is turned off

The seat and steering wheel will move to the original position when:

- the transmission is in N (Neutral) or P (Park)
- the ignition is put in accessory mode

The easy entry feature can be turned off or on through the vehicle message center. Refer to *Message center* in the *Instrument Cluster* chapter.

REAR SEATS

Rear seat head restraints

Your vehicle is equipped with rear seat outboard head restraints that look differently than the front head restraints, but function similarly.



WARNING: To minimize the risk of neck injury in the event of a crash, the driver and passenger occupants should not sit in and/or operate the vehicle, until the head restraint is placed in its proper position. The driver should never adjust the head restraint while the vehicle is in motion.

For details about how to raise, lower and remove the rear head restraints, refer to *Adjustable head restraints* at the beginning of this chapter.

The center rear head restraint is fixed and non-adjustable.

Folding down the 60/40 rear seats

Note: The head restraints should be placed in the full down position before folding the seatback down.

Note: Ensure that no objects such as books, purses, or briefcases are on the floor in front of, on or under the second row seat cushion before actuating the release lever to cycle the seats to the load-floor position.

124

Seating and Safety Restraints

 **WARNING:** To prevent possible damage to the seat or safety belts, ensure that the safety belts are not buckled when moving the seat to the load floor position.

2nd row manual folding seat

To fold down the rear seat, pull up on the lever on the outboard side of the seat cushion and let the seatback rotate downward into the load floor position.

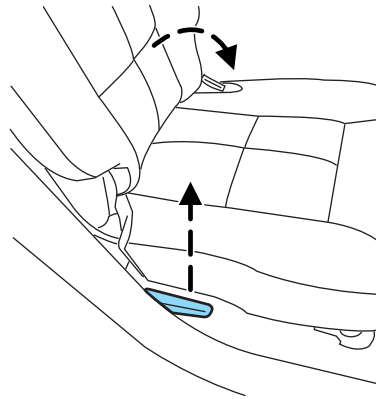

2nd row EasyFold™ seatback release (if equipped)

 **WARNING:** Ensure that the seat is unoccupied when folding it down. Folding the seat while occupied could result in damage to the seat or injury.

Note: The power feature is operational when the vehicle is in park and the liftgate has been open for less than 10 minutes.

The control buttons are located on the left-hand rear quarter trim panel (accessible from the liftgate area).

Seating and Safety Restraints

Press and hold the control mechanism to lower the seatback. The top portion lowers the right (40%) seatback, and the bottom portion lowers the left (60%) seatback.

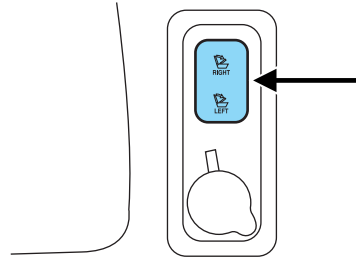

Returning the 2nd row seatback to the upright position

WARNING: Before returning the seatback to its original position, make sure that cargo or any objects are not trapped behind the seatback. After returning the seatback to its original position, pull on the seatback to ensure that the latches are engaged. An unlatched seat may become dangerous in the event of a sudden stop or collision.

Rotate the seatback upward until the seatback latches in the upright position. The seatback will click when it is locked into position.

Adjusting the second row seatback

WARNING: Reclining the seatback can cause an occupant to slide under the seat's safety belt, resulting in severe personal injuries in the event of a collision.

The second row seat reclines for additional comfort. To adjust the second row seatback to the desired position, while seated, pull the release lever up and push the seatback rearward.

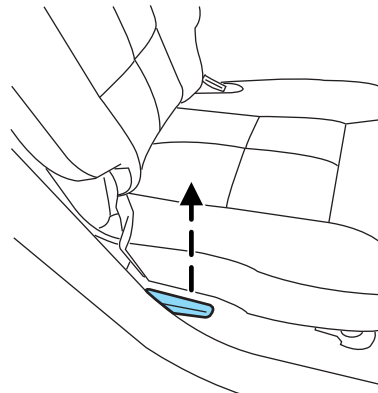

Seating and Safety Restraints

Seat-mounted armrest and cupholders

Your vehicle is equipped with a rear seat armrest. To fold the armrest down, release the latch located on the seatback by pressing down and pulling forward.

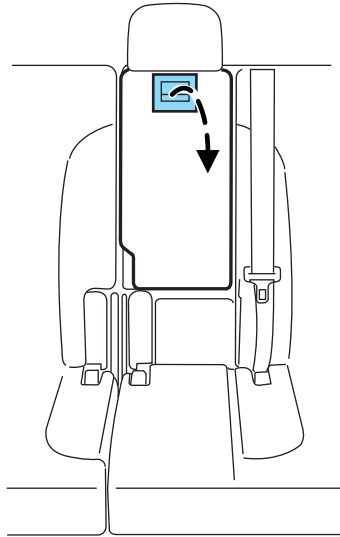

To access the cup holders, lift up one of the slotted areas on the cover.

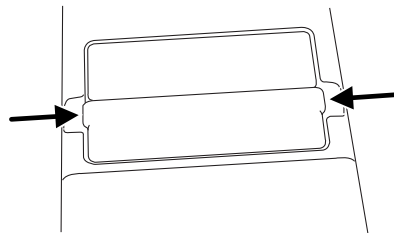

WARNING: Use only soft cups in the cupholder. Hard objects can injure you in a collision.

Returning the 2nd row armrest to the upright position

Close the cover on the cup holders. Rotate the armrest rearward until the armrest is in the latched position. The armrest will click when it is latched into position.

127

Seating and Safety Restraints

Rear heated seats (if equipped)

⚠ WARNING: Persons who are unable to feel pain to the skin because of advanced age, chronic illness, diabetes, spinal cord injury, medication, alcohol use, exhaustion, or other physical conditions, must exercise care when using the seat heater. The seat heater may cause burns even at low temperatures, especially if used for long periods of time. Do not place anything on the seat that insulates against heat, such as a blanket or cushion, because this may cause the seat heater to overheat. Do not puncture the seat with pins, needles, or other pointed objects because this may damage the heating element which may cause the seat heater to overheat. An overheated seat may cause serious personal injury.

Note: Do not do the following:

- Place heavy objects on the seat
- Operate the seat heater if water or any other liquid is spilled on the seat. Allow the seat to dry thoroughly.

The rear seat heat controls are located on the rear door panels.

To operate the heated seats:

- Press the indicated side of the control for maximum heat.
- Press again to deactivate.

- Press the indicated side of the control for minimum heat.
- Press again to deactivate.

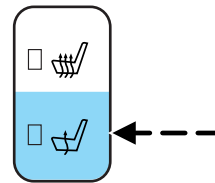
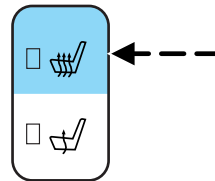

The heated seat module resets at every ignition run cycle. While the ignition is in the on position, activating the high or low heated seat switch enables heating mode. When activated, they will turn off automatically when the engine is turned off.

The indicator light will illuminate when the heated seats have been activated.

128

Seating and Safety Restraints

SAFETY RESTRAINTS

Personal Safety System™

The Personal Safety System provides an improved overall level of frontal crash protection to front seat occupants and is designed to help further reduce the risk of airbag-related injuries. The system is able to analyze different occupant conditions and crash severity before activating the appropriate safety devices to help better protect a range of occupants in a variety of frontal crash situations.

Your vehicle's Personal Safety System consists of:

- Driver and passenger dual-stage airbag supplemental restraints.
- Front outboard safety belts with pretensioners, energy management retractors (first row only), and safety belt usage sensors.
- Driver's seat position sensor.
- Front passenger sensing system
- Passenger airbag off/on indicator lamp
- Front crash severity sensors.
- Restraints Control Module (RCM) with impact and safing sensors.
- Restraint system warning light and backup tone.
- The electrical wiring for the airbags, crash sensor(s), safety belt pretensioners, front safety belt usage sensors, driver seat position sensor, front passenger sensing system, and indicator lights.

How does the Personal Safety System work?

The Personal Safety System can adapt the deployment strategy of your vehicle's safety devices according to crash severity and occupant conditions. A collection of crash and occupant sensors provides information to the Restraints Control Module (RCM). During a crash, the RCM may activate the safety belt pretensioners and/or either one or both stages of the dual-stage airbag supplemental restraints based on crash severity and occupant conditions.

The fact that the pretensioners or airbags did not activate for both front seat occupants in a collision does not mean that something is wrong with the system. Rather, it means the Personal Safety System determined the accident conditions (crash severity, belt usage, etc.) were not appropriate to activate these safety devices. Front airbags are designed to activate only in frontal and near-frontal collisions (not rollovers, side impacts or rear impacts) unless the collision causes sufficient

129

Seating and Safety Restraints

longitudinal deceleration. The pretensioners are designed to activate in frontal and near-frontal collisions, and in rollovers and side collisions when the Safety Canopy® is activated.

Driver and passenger dual-stage airbag supplemental restraints

The dual-stage airbags offer the capability to tailor the level of airbag inflation energy. A lower, less forceful energy level is provided for more common, moderate-severity impacts. A higher energy level is used for the most severe impacts. Refer to *Airbag supplemental restraints (SRS)* section in this chapter.

Front crash severity sensor

The front crash severity sensor enhances the ability to detect the severity of an impact. Positioned up front, it provides valuable information early in the crash event on the severity of the impact. This allows your Personal Safety System to distinguish between different levels of crash severity and modify the deployment strategy of the dual-stage airbags and safety belt pretensioners.

Driver's seat position sensor

The driver's seat position sensor allows your Personal Safety System to tailor the deployment level of the driver dual-stage airbag based on seat position. The system is designed to help protect smaller drivers sitting close to the driver airbag by providing a lower airbag output level.

Front passenger sensing system

For airbags to do their job they must inflate with great force, and this force can pose a potentially deadly risk to occupants that are very close to the airbag when it begins to inflate. For some occupants, this occurs because they are initially sitting very close to the airbag. For other occupants, this occurs when the occupant is not properly restrained by safety belts or child safety seats and they move forward during pre-crash braking. The most effective way to reduce the risk of unnecessary injuries is to make sure all occupants are properly restrained. Accident statistics suggest that children are much safer when properly restrained in the rear seating positions than in the front.



WARNING: Air bags can kill or injure a child in a child seat. **NEVER** place a rear-facing child seat in front of an active air bag. If you must use a forward-facing child seat in the front seat, move the seat all the way back.

Seating and Safety Restraints



WARNING: Always transport children 12 years old and under in the back seat and always properly use appropriate child restraints.

The front passenger sensing system can automatically turn off the front passenger airbag and passenger seat-mounted side airbag. The system is designed to help protect small (child size) occupants from frontal airbag deployments when they are seated or restrained in the front passenger seat contrary to proper child-seating or restraint usage recommendations. Even with this technology, parents are **STRONGLY** encouraged to always properly restrain children in the rear seat. The sensor also turns off the passenger front airbag and passenger seat-mounted side airbag when the passenger seat is empty and the safety belt is unbuckled.

Front safety belt usage sensors

The front safety belt usage sensors detect whether or not the driver and front outboard passenger safety belts are fastened. This information allows your Personal Safety System to tailor the airbag deployment and safety belt pretensioner activation depending upon safety belt usage.

Front safety belt pretensioners

The safety belt pretensioners at the front outboard seating positions are designed to tighten the safety belts firmly against the occupant's body during frontal collisions, and in rollover and side collisions when the Safety Canopy® is activated. This helps increase the effectiveness of the safety belts. In frontal collisions, the safety belt pretensioners can be activated alone or, if the collision is of sufficient severity, together with the front airbags.

Front safety belt energy management retractors

The front outboard safety belt energy management retractors allow webbing to be pulled out of the retractor in a gradual and controlled manner in response to the occupant's forward momentum. This helps reduce the risk of force-related injuries to the occupant's chest by limiting the load on the occupant. Refer to *Energy management feature — front outboard* section in this chapter.

Determining if the Personal Safety System is operational

The Personal Safety System uses a warning light in the instrument cluster or a back-up tone to indicate the condition of the system. Refer to the *Warning lights and chimes* section in the *Instrument Cluster* chapter. Routine maintenance of the Personal Safety System is not required.

Seating and Safety Restraints

The Restraints Control Module (RCM) monitors its own internal circuits and the circuits for the airbag supplemental restraints, crash sensor(s), safety belt pretensioners, front safety belt buckle sensors, driver seat position sensor, and front passenger sensing system. In addition, the RCM also monitors the restraints warning light in the instrument cluster. A difficulty with the system is indicated by one or more of the following.

- The warning light will either flash or stay lit.
- The warning light will not illuminate immediately after ignition is turned on.
- A series of five beeps will be heard. The tone pattern will repeat periodically until the problem and warning light are repaired.

If any of these things happen, even intermittently, have the Personal Safety System serviced at an authorized dealer immediately. Unless serviced, the system may not function properly in the event of a collision.

Safety belt precautions



WARNING: Always drive and ride with your seatback upright and the lap belt snug and low across the hips.



WARNING: To reduce the risk of injury, make sure children sit where they can be properly restrained.



WARNING: Never let a passenger hold a child on his or her lap while the vehicle is moving. The passenger cannot protect the child from injury in a collision.



WARNING: All occupants of the vehicle, including the driver, should always properly wear their safety belts, even when an air bag supplemental restraint system (SRS) is provided.



WARNING: It is extremely dangerous to ride in a cargo area, inside or outside of a vehicle. In a collision, people riding in these areas are more likely to be seriously injured or killed. Do not allow people to ride in any area of your vehicle that is not equipped with seats and safety belts. Be sure everyone in your vehicle is in a seat and using a safety belt properly.

Seating and Safety Restraints



WARNING: In a rollover crash, an unbelted person is significantly more likely to die than a person wearing a seat belt.



WARNING: Each seating position in your vehicle has a specific safety belt assembly which is made up of one buckle and one tongue that are designed to be used as a pair. 1) Use the shoulder belt on the outside shoulder only. Never wear the shoulder belt under the arm. 2) Never swing the safety belt around your neck over the inside shoulder. 3) Never use a single belt for more than one person.



WARNING: When possible, all children 12 years old and under should be properly restrained in a rear seating position.



WARNING: Front and rear seat occupants, including pregnant women, should wear safety belts for optimum protection in an accident.

Combination lap and shoulder belts

1. Insert the belt tongue into the proper buckle (the buckle closest to the direction the tongue is coming from) until you hear a snap and feel it latch. Make sure the tongue is securely fastened in the buckle.

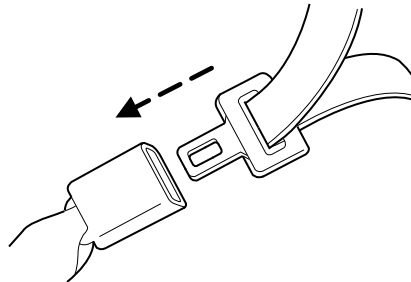

Seating and Safety Restraints

2. To unfasten, press the release button and remove the tongue from the buckle.

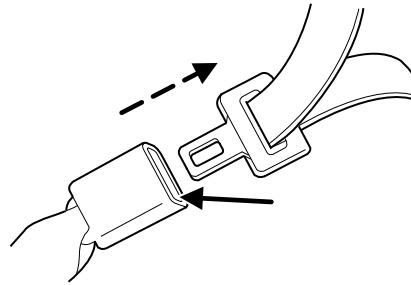

Restraint of pregnant women

! **WARNING:** Always ride and drive with your seatback upright and the safety belt properly fastened. The lap portion of the safety belt should fit snug and be positioned low across the hips. The shoulder portion of the safety belt should be positioned across the chest. Pregnant women should also follow this practice. See figure below.

Pregnant women should always wear their safety belt. The lap belt portion of a combination lap and shoulder belt should be positioned low across the hips below the belly and worn as tight as comfort will allow. The shoulder belt should be positioned to cross the middle of the shoulder and the center of the chest.

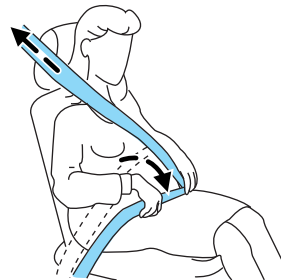

Safety belt locking modes

All safety restraints in the vehicle are combination lap and shoulder belts. The driver safety belt has the first locking mode and the front outboard passenger and rear seat safety belts have both types of locking modes described as follows:

Vehicle sensitive mode

This is the normal retractor mode, which allows free shoulder belt length adjustment to your movements and locking in response to vehicle movement. For example, if the driver brakes suddenly or turns a corner sharply, or the vehicle receives an impact of approximately 5 mph

134

Seating and Safety Restraints

(8 km/h) or more, the combination safety belts will lock to help reduce forward movement of the driver and passengers.

In addition, the retractor is designed to lock if the webbing is pulled out too quickly. If this occurs, let the belt retract slightly and pull webbing out again in a slow and controlled manner.

Automatic locking mode

In this mode, the shoulder belt is automatically pre-locked. The belt will still retract to remove any slack in the shoulder belt. The automatic locking mode is not available on the driver safety belt.

When to use the automatic locking mode

This mode should be used **any time** a child safety seat, except a booster, is installed in passenger front or rear seating positions. Children 12 years old and under should be properly restrained in a rear seating position whenever possible. Refer to *Safety restraints for children* or *Safety seats for children* later in this chapter.

How to use the automatic locking mode

- Buckle the combination lap and shoulder belt.

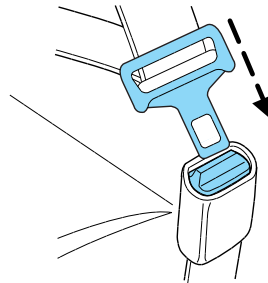

- Grasp the shoulder portion and pull downward until the entire belt is pulled out.





- Allow the belt to retract. As the belt retracts, you will hear a clicking sound. This indicates the safety belt is now in the automatic locking mode.

Seating and Safety Restraints

How to disengage the automatic locking mode

Disconnect the combination lap/shoulder belt and allow it to retract completely to disengage the automatic locking mode and activate the vehicle sensitive (emergency) locking mode.

 **WARNING:** After any vehicle collision, the safety belt system at all passenger seating positions must be checked by an authorized dealer to verify that the “automatic locking retractor” feature for child seats is still functioning properly. In addition, all safety belts should be checked for proper function.

 **WARNING:** BELT AND RETRACTOR ASSEMBLY MUST BE REPLACED if the safety belt assembly “automatic locking retractor” feature or any other safety belt function is not operating properly when checked by an authorized dealer. Failure to replace the belt and retractor assembly could increase the risk of injury in collisions.

Energy management feature — front outboard

- This vehicle has a safety belt system with an energy management feature at the front seats to help further reduce the risk of injury in the event of a head-on collision.
- The energy management feature has a retractor assembly that is designed to extend the safety belt webbing in a controlled manner. This helps reduce the belt force acting on the user's chest.

 **WARNING:** Failure to inspect and replace if necessary the belt and retractor assembly after an accident could increase the risk of injury in a collision.

Safety belt pretensioner

Your vehicle is equipped with safety belt pretensioners at the driver and front outboard passenger seating positions.

The safety belt pretensioner tightens the safety belts firmly against the occupant's body at the start of the crash.

 **WARNING:** The driver and front passenger safety belt system (including retractors, buckles and height adjusters) must be replaced if the vehicle is involved in a collision that results in deployment of front airbags, seat-mounted side airbags and Safety Canopy® System and safety belt pretensioners.

Seating and Safety Restraints

Safety belt extension assembly

If the safety belt is too short when fully extended, there is an 8 inch (20 cm) safety belt extension assembly that can be added (part number 611C22). This assembly can be obtained from an authorized dealer.

Use only extensions manufactured by the same supplier as the safety belt. Manufacturer identification is located at the end of the webbing on the label. Also, use the safety belt extension only if the safety belt is too short for you when fully extended.



WARNING: Do not use extensions to change the fit of the shoulder belt across the torso.

Safety belt height adjustment

Your vehicle has safety belt height adjustments at the front outboard seating positions. Adjust the height of the shoulder belt so the belt rests across the middle of your shoulder.

To adjust the shoulder belt height, pull on the center button and slide the height adjuster up or down. Release the button and pull down on the height adjuster to make sure it is locked in place.

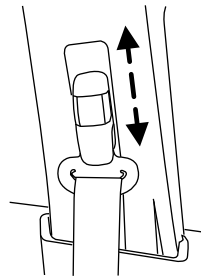

WARNING: Position the safety belt height adjusters so that the belt rests across the middle of your shoulder. Failure to adjust the safety belt properly could reduce the effectiveness of the safety belt and increase the risk of injury in a collision.

Seating and Safety Restraints

Second row comfort guide

The second row outboard lap/shoulder belt is equipped with a belt comfort guide. This guide is attached to the head restraint and is stored in a pocket in the seatback. It is used to adjust the comfort of the shoulder belt for smaller occupants in the outboard second row seats.

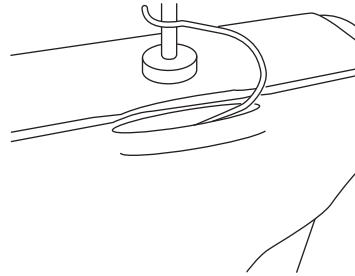

To adjust the comfort guide:

1. Slip the shoulder belt into the belt guide.
2. Slide the guide up or down along the webbing so that the belt is centered on the occupant's shoulder.

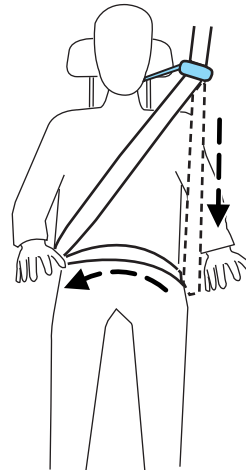

WARNING: Position the safety belt comfort guide so that the belt rests across the middle of your shoulder. Failure to adjust the safety belt properly could reduce the effectiveness of the safety belt and increase the risk of injury in a collision.

Seating and Safety Restraints

Safety belt warning light and indicator chime

The safety belt warning light illuminates in the instrument cluster and a chime sounds to remind the occupants to fasten their safety belts.

Conditions of operation

| If... | Then... |
|---|---|
| The driver's safety belt is not buckled before the ignition switch is turned to the on position... | The safety belt warning light illuminates 1-2 minutes and the warning chime sounds 4-8 seconds. |
| The driver's safety belt is buckled while the indicator light is illuminated and the warning chime is sounding... | The safety belt warning light and warning chime turn off. |
| The driver's safety belt is buckled before the ignition switch is turned to the on position... | The safety belt warning light and indicator chime remain off. |

Belt-Minder®

The Belt-Minder® feature is a supplemental warning to the safety belt warning function. This feature provides additional reminders by intermittently sounding a chime and illuminating the safety belt warning light in the instrument cluster when the driver's and front passenger's safety belt is unbuckled.

The Belt-Minder® feature uses information from the front passenger sensing system to determine if a front seat passenger is present and therefore potentially in need of a warning. To avoid activating the Belt-Minder® feature for objects placed in the front passenger seat, warnings will only be given to large front seat occupants as determined by the front passenger sensing system.

Both the driver's and passenger's safety belt usages are monitored and either may activate the Belt-Minder® feature. The warnings are the same for the driver and the front passenger. If the Belt-Minder® warnings have expired (warnings for approximately five minutes) for one occupant (driver or front passenger), the other occupant can still activate the Belt-Minder® feature.

Seating and Safety Restraints

| If... | Then... |
|---|--|
| The driver's and front passenger's safety belts are buckled before the ignition switch is turned to the on position or less than 1-2 minutes have elapsed since the ignition switch has been turned to on... | The Belt-Minder® feature will not activate. |
| The driver's or front passenger's safety belt is not buckled when the vehicle has reached at least 3 mph (5 km/h) and 1-2 minutes have elapsed since the ignition switch has been turned to on... | The Belt-Minder® feature is activated - the safety belt warning light illuminates and the warning chime sounds for six seconds every 30 seconds, repeating for approximately five minutes or until the safety belts are buckled. |
| The driver's or front passenger's safety belt becomes unbuckled for approximately one minute while the vehicle is traveling at least 3 mph (5 km/h) and more than 1-2 minutes have elapsed since the ignition switch has been turned to on... | The Belt-Minder® feature is activated - the safety belt warning light illuminates and the warning chime sounds for six seconds every 30 seconds, repeating for approximately five minutes or until the safety belts are buckled. |

Seating and Safety Restraints

The following are reasons most often given for not wearing safety belts
(All statistics based on U.S. data):

| Reasons given... | Consider.. |
|--|--|
| “Crashes are rare events” | 36700 crashes occur every day. The more we drive, the more we are exposed to “rare” events, even for good drivers. <i>1 in 4 of us will be seriously injured in a crash during our lifetime.</i> |
| “I’m not going far” | 3 of 4 fatal crashes occur within 25 miles (40 km) of home. |
| “Belts are uncomfortable” | We design our safety belts to enhance comfort. If you are uncomfortable - try different positions for the safety belt upper anchorage and seatback which should be as upright as possible; this can improve comfort. |
| “I was in a hurry” | Prime time for an accident. Belt-Minder® reminds us to take a few seconds to buckle up. |
| “Safety belts don’t work” | Safety belts , when used properly, reduce risk of death to front seat occupants by 45% in cars , and by 60% in light trucks . |
| “Traffic is light” | Nearly 1 of 2 deaths occur in single-vehicle crashes , many when no other vehicles are around. |
| “Belts wrinkle my clothes” | Possibly, but a serious crash can do much more than wrinkle your clothes, particularly if you are unbelted. |
| “The people I’m with don’t wear belts” | Set the example, teen deaths occur 4 times more often in vehicles with TWO or MORE people. Children and younger brothers/sisters imitate behavior they see. |
| “I have an airbag” | Airbags offer greater protection when used with safety belts. Frontal airbags are not designed to inflate in rear and side crashes or rollovers. |
| “I’d rather be thrown clear” | Not a good idea. People who are ejected are 40 times more likely to DIE. Safety belts help prevent ejection, WE CAN’T “PICK OUR CRASH”. |



WARNING: Do not sit on top of a buckled safety belt or insert a latchplate into the buckle to avoid the Belt-Minder® chime. To do so may adversely affect the performance of the vehicle’s airbag system.

Seating and Safety Restraints

One-time disable

If at any time the driver/front passenger quickly buckles then unbuckles the safety belt for that seating position, the Belt-Minder® is disabled for the current ignition cycle. The Belt-Minder® feature will enable during the same ignition cycle if the occupant buckles and remains buckled for approximately 30 seconds. Confirmation is not given for the one-time disable.

Deactivating/activating the Belt-Minder® feature

The driver and front passenger Belt-Minder® are deactivated/activated independently. When deactivating/activating one seating position, do not buckle the other position as this will terminate the process.

Read Steps 1 - 4 thoroughly before proceeding with the deactivation/activation programming procedure.

Note: The driver and front passenger Belt-Minder® features must be disabled/enabled separately. Both cannot be disabled/enabled during the same key cycle.

The driver and front passenger Belt-Minder® features can be deactivated/activated by performing the following procedure:

Before following the procedure, make sure that:

- The parking brake is set.
- The gearshift is in P (Park).
- The ignition is off.
- The driver and front passenger safety belts are unbuckled.



WARNING: While the design allows you to deactivate your Belt-Minder®, this system is designed to improve your chances of being safely belted and surviving an accident. We recommend you leave the Belt-Minder® system activated for yourself and others who may use the vehicle. To reduce the risk of injury, do not deactivate/activate the Belt-Minder® feature while driving the vehicle.

1. Turn the ignition on. DO NOT START THE ENGINE.
 2. Wait until the safety belt warning light turns off (approximately 1-2 minutes).
- Step 3 must be completed within 50 seconds after the safety belt warning light turns off.

142

Seating and Safety Restraints

3. For the seating position being disabled, buckle then unbuckle the safety belt three times at a moderate speed, ending in the unbuckled state.

- After Step 3, the safety belt warning light will be turned on for three seconds.
- 4. Within approximately seven seconds of the light turning off, buckle then unbuckle the safety belt.
 - This will disable the Belt-Minder® feature for that seating position if it is currently enabled. As confirmation, the safety belt warning light will flash 12 times in three seconds.
 - This will enable the Belt-Minder® feature for that seating position if it is currently disabled. As confirmation, the safety belt warning light will flash 12 times in three seconds.

AIRBAG SUPPLEMENTAL RESTRAINT SYSTEM (SRS)



Seating and Safety Restraints

Important supplemental restraint system precautions

Airbags DO NOT inflate slowly or gently and the risk of injury from a deploying airbag is greatest close to the trim covering the airbag module.

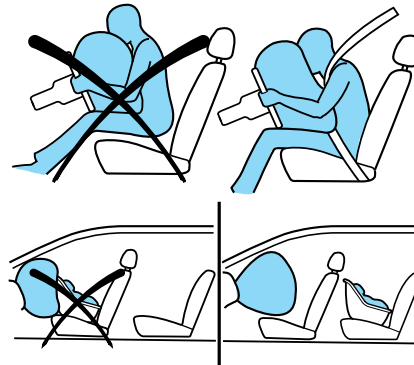

WARNING: All occupants of the vehicle, including the driver, should always properly wear their safety belts, even when an air bag supplemental restraint system (SRS) is provided.

WARNING: When possible, all children 12 years old and under should be properly restrained in a rear seating position.

WARNING: National Highway Traffic Safety Administration (NHTSA) recommends a minimum distance of at least 10 inches (25 cm) between an occupant's chest and the driver airbag module.

WARNING: Never place your arm over the airbag module as a deploying airbag can result in serious arm fractures or other injuries.

Steps you can take to properly position yourself away from the airbag:

- Move your seat to the rear as far as you can while still reaching the pedals comfortably.
- Recline the seat slightly (one or two degrees) from the upright position.

Seating and Safety Restraints

 **WARNING:** Do not put anything on or over the airbag module. Placing objects on or over the airbag inflation area may cause those objects to be propelled by the airbag into your face and torso causing serious injury.

 **WARNING:** Do not attempt to service, repair, or modify the airbag supplemental restraint system (SRS) or its fuses. See your authorized dealer.

 **WARNING:** Modifying or adding equipment to the front end of the vehicle (including frame, bumper, front end body structure and tow hooks) may affect the performance of the airbag system, increasing the risk of injury. Do not modify the front end of the vehicle.

Children and airbags

Children must always be properly restrained. Accident statistics suggest that children are safer when properly restrained in the rear seating positions than in the front seating position. Failure to follow these instructions may increase the risk of injury in a collision.

 **WARNING:** Airbags can kill or injure a child in a child seat. **NEVER** place a rear-facing child seat in front of an active airbag. If you must use a forward-facing child seat in the front seat, move the seat all the way back.

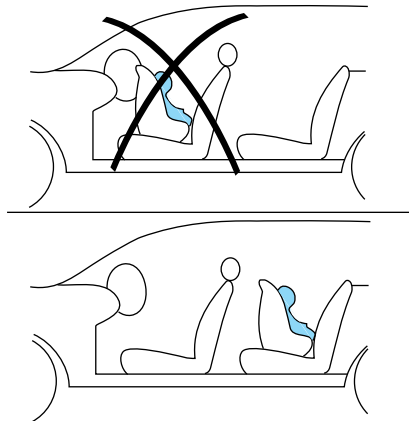

Seating and Safety Restraints

How does the safety belt pretensioner and airbag supplemental restraint system work?

The safety belt pretensioner and airbag SRS are designed to activate when the vehicle sustains longitudinal deceleration sufficient to cause the sensors to close an electrical circuit that initiates pretensioner activation and airbag inflation.

The fact that the airbags did not activate in a collision does not mean that something is wrong with the system. Rather, it means the forces were not of the type sufficient to cause activation. Front airbags are designed to activate in frontal and near-frontal collisions, not rollover, side-impact, or rear-impacts unless the collision causes sufficient longitudinal deceleration.

The airbags inflate and deflate rapidly upon activation. After airbag deployment, it is normal to notice a smoke-like, powdery residue or smell the burnt propellant. This may consist of cornstarch, talcum powder (to lubricate the bag) or sodium compounds (e.g., baking soda) that result from the combustion process that inflates the airbag. Small amounts of sodium hydroxide may be present which may irritate the skin and eyes, but none of the residue is toxic.

While the system is designed to help reduce serious injuries, contact with a deploying airbag may also cause abrasions, swelling or temporary hearing loss. Because airbags must inflate rapidly and with considerable force, there is the risk of death or serious injuries such as fractures, facial and eye injuries or internal injuries, particularly to occupants who are not properly restrained or are otherwise out of position at the time of airbag deployment. Thus, it is extremely important that occupants be properly restrained as far away from the airbag module as possible while maintaining vehicle control.

146

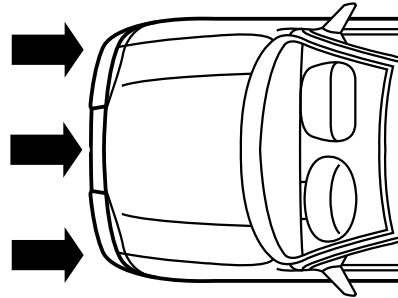

Seating and Safety Restraints



WARNING: Several air bag system components get hot after inflation. Do not touch them after inflation.



WARNING: If the air bag has deployed, **the air bag will not function again and must be replaced immediately.** If the air bag is not replaced, the unrepaired area will increase the risk of injury in a collision.

The SRS consists of:

- driver and passenger airbag modules (which include the inflators and airbags)
- seat-mounted side airbags. Refer to *Seat-mounted side airbag system* later in this chapter
- safety belt pretensioners
- one or more impact and safing sensors
- a readiness light and tone
- and the electrical wiring which connects the components
- Side curtain airbag system. Refer to *Safety Canopy® System* later in this chapter.
- Front passenger sensing system. Refer to *Front passenger sensing system* later in this chapter.
- “Passenger airbag off” or “pass airbag off” indicator lamp. Refer to *Front passenger sensing system* later in this chapter.

The diagnostic module monitors its own internal circuits and the supplemental airbag electrical system wiring (including the impact sensors), the system wiring, the airbag system readiness light, the airbag backup power, the airbag ignitors and safety belt pretensioners.

Front passenger sensing system

The front passenger sensing system is designed to meet the regulatory requirements of Federal Motor Vehicle Safety Standard (FMVSS) 208 and is designed to disable (will not inflate) the front passenger's frontal airbag under certain conditions.

The front passenger sensing system works with sensors that are part of the front passenger's seat and safety belt. The sensors are designed to detect the presence of a properly seated occupant and determine if the front passenger's frontal airbag should be enabled (may inflate) or disabled (will not inflate).

Seating and Safety Restraints

The front passenger sensing system will disable (will not inflate) the front passenger's frontal airbag if:

- the front passenger seat is unoccupied, or has small/medium objects in the front seat.
- the system determines that an infant is present in a rear-facing infant seat that is installed according to the manufacturer's instructions.
- the system determines that a small child is present in a forward-facing child restraint that is installed according to the manufacturer's instructions.
- the system determines that a small child is present in a booster seat.
- a front passenger takes his/her weight off of the seat for a period of time.

Passenger airbag status indicator

The front passenger sensing system uses a passenger airbag status indicator which will illuminate indicating that the front passenger frontal airbag is either ON (enabled) or OFF (disabled). The indicator lamp is located in the center stack of the instrument panel.



Note: The passenger airbag status indicator OFF and ON lamps will illuminate for a short period of time when the ignition is first turned on to confirm it is functional.

The front passenger sensing system is designed to disable (will not inflate) the front passenger's frontal airbag when the front passenger seat is unoccupied, or a rear facing infant seat, a forward-facing child restraint, or a booster seat is detected.

- When the front passenger sensing system disables (will not inflate) the front passenger frontal airbag, the passenger airbag status indicator will illuminate the OFF lamp and stay lit to remind you that the front passenger frontal airbag is disabled.
- If the child restraint has been installed and the passenger airbag status indicator illuminates the ON lamp, then turn the vehicle off, remove the child restraint from the vehicle and reinstall the restraint following the child restraint manufacturer's instructions.

The front passenger sensing system is designed to enable (may inflate) the front passenger's frontal airbag anytime the system senses that a person of adult size is sitting properly in the front passenger seat.

148

Seating and Safety Restraints

- When the front passenger sensing system enables the front passenger frontal airbag (may inflate), the passenger airbag status indicator will illuminate the ON lamp and remain illuminated.

If a person of adult size is sitting in the front passenger's seat, but the passenger airbag status indicator OFF lamp is lit, it is possible that the person isn't sitting properly in the seat. If this happens:

- Turn the vehicle off and ask the person to place the seatback in the full upright position.
- Have the person sit upright in the seat, centered on the seat cushion, with the person's legs comfortably extended.
- Restart the vehicle and have the person remain in this position for about two minutes. This will allow the system to detect that person and enable the passenger's frontal airbag.
- If the passenger airbag status indicator OFF lamp remains lit even after this, the person should be advised to ride in the rear seat.

| Occupant | Passenger Airbag Status Indicator | Passenger Airbag |
|----------|-----------------------------------|------------------|
| Empty | OFF: Lit | Disabled |
| | ON: Unlit | |
| Child | OFF: Lit | Disabled |
| | ON: Unlit | |
| Adult | OFF: Unlit | Enabled |
| | ON: Lit | |

Note: When the passenger airbag status indicator OFF lamp is illuminated, the passenger side airbag (seat mounted) may be disabled to avoid the risk of airbag deployment injuries.



WARNING: Even with Advanced Restraints Systems, children 12 and under should be properly restrained in a rear seating position.

After all occupants have adjusted their seats and put on safety belts, it's very important that they continue to sit properly. A properly seated occupant sits upright, leaning against the seat back, and centered on the seat cushion, with their feet comfortably extended on the floor. Sitting improperly can increase the chance of injury in a crash event. For example, if an occupant slouches, lies down, turns sideways, sits forward, leans forward or sideways, or puts one or both feet up, the chance of injury during a crash is greatly increased.

Seating and Safety Restraints

 **WARNING:** Sitting improperly out of position or with the seat back reclined too far can take off weight from the seat cushion and affect the decision of the front passenger sensing system, resulting in serious injury or death in a crash. Always sit upright against your seatback, with your feet on the floor.

If you think that the state of the passenger airbag status indicator lamp is incorrect, check for the following:

- Objects lodged underneath the seat
- Objects between the seat cushion and the center console (if equipped)
- Objects hanging off the seat back
- Objects stowed in the seatback map pocket (if equipped)
- Objects placed on the occupant's lap
- Cargo interference with the seat
- Other passengers pushing or pulling on the seat
- Rear passenger feet and knees resting or pushing on the seat

The conditions listed above may cause the weight of a properly seated occupant to be incorrectly interpreted by the front passenger sensing system. The person in the front passenger seat may appear heavier or lighter due to the conditions described in the list above.

 **WARNING:** To reduce the risk of possible serious injury: Do not stow objects in seat back map pocket (if equipped) or hang objects off seat back if a child is in the front passenger seat. Do not place objects underneath the front passenger seat or between the seat and the center console (if equipped). Check the passenger airbag status indicator lamp for proper airbag status. Failure to follow these instructions may interfere with the front passenger seat sensing system.

In case there is a problem with the front passenger sensing system, the airbag readiness light in the instrument cluster will stay lit.



If the airbag readiness light is lit, do the following:

The driver and/or adult passengers should check for any objects that may be lodged underneath the front passenger seat or cargo interfering with the seat.

150

Seating and Safety Restraints

If objects are lodged and/or cargo is interfering with the seat; please take the following steps to remove the obstruction:

- Pull the vehicle over.
- Turn the vehicle off.
- Driver and/or adult passengers should check for any objects lodged underneath the front passenger seat or cargo interfering with the seat.
- Remove the obstruction(s) (if found).
- Restart the vehicle.
- Wait at least two minutes and verify that the airbag readiness light in the instrument cluster is no longer illuminated
- If the airbag readiness light in the instrument cluster remains illuminated, this may or may/not be a problem due to the front passenger sensing system.

DO NOT attempt to repair or service the system; take your vehicle immediately to an authorized dealer.

If it is necessary to modify an advanced front airbag system to accommodate a person with disabilities, contact the Ford Customer Relationship Center at the phone number shown in the *Customer Assistance* section of this *Owner's Guide*.



WARNING: Any alteration/modification to the front passenger seat may affect the performance of the front passenger sensing system.

Determining if the system is operational

The supplemental restraint system uses a warning indicator light in the instrument cluster or a backup tone to indicate the condition of the system. Refer to the *Warning lights and chimes* section in the *Instrument Cluster* chapter. Routine maintenance of the airbag is not required.

A difficulty with the system is indicated by one or more of the following:

- The readiness light (same light for front and side airbag system) will either flash or stay lit.
- The readiness light will not illuminate immediately after ignition is turned on.
- A series of five beeps will be heard. The tone pattern will repeat periodically until the problem and/or light are repaired.



Seating and Safety Restraints

If any of these things happen, even intermittently, have the supplemental restraint system serviced at an authorized dealer immediately. Unless serviced, the system may not function properly in the event of a collision.

Seat-mounted side airbag system

 **WARNING:** Do not place objects or mount equipment on or near the airbag cover on the side of the seatbacks of the front seats or in front seat areas that may come into contact with a deploying airbag. Failure to follow these instructions may increase the risk of personal injury in the event of a collision.

 **WARNING:** Do not use accessory seat covers. The use of accessory seat covers may prevent the deployment of the side airbags and increase the risk of injury in an accident.

 **WARNING:** Do not lean your head on the door. The side airbag could injure you as it deploys from the side of the seatback.

 **WARNING:** Do not attempt to service, repair, or modify the airbag SRS, its fuses or the seat cover on a seat containing an airbag. Contact your authorized dealer as soon as possible.

 **WARNING:** All occupants of the vehicle should always wear their safety belts even when an airbag SRS is provided.

How does the side airbag system work?

The design and development of the side airbag system included recommended testing procedures that were developed by a group of automotive safety experts known as the Side Airbag Technical Working Group. These recommended testing procedures help reduce the risk of injuries related to the deployment of side airbags.

Seating and Safety Restraints

The side airbag system consists of the following:

- An inflatable bag (airbag) with a gas generator concealed behind the outboard bolster of the driver and front passenger seatbacks.
- The same warning light, electronic control and diagnostic unit as used for the front airbags.
- The same readiness airbag light, electronic control and diagnostic unit as used for the front airbags.
- Crash sensors mounted in each front door.
- Two crash sensors located at the C pillar behind the rear doors (one on each side of the vehicle).

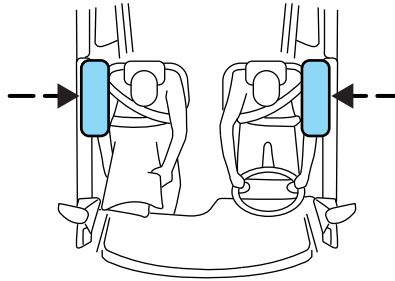

Side airbags, in combination with safety belts, can help reduce the risk of severe injuries in the event of a significant side impact collision.

The side airbags are fitted on the outboard side of the seatbacks of the front seats. In certain lateral collisions, the airbag on the side affected by the collision will be inflated. The airbag was designed to inflate between the door panel and occupant to further enhance the protection provided occupants in side impact collisions.

The airbag SRS is designed to activate when the vehicle sustains lateral deceleration sufficient to cause the sensors to close an electrical circuit that initiates airbag inflation.

The fact that the airbags did not inflate in a collision does not mean that something is wrong with the system. Rather, it means the forces were not of the type sufficient to cause activation. Side airbags are designed to inflate in side-impact collisions, not roll-over, rear-impact, frontal or near-frontal collisions, unless the collision causes sufficient lateral deceleration.



WARNING: Several air bag system components get hot after inflation. Do not touch them after inflation.

Seating and Safety Restraints

 **WARNING:** If the side airbag has deployed, **the airbag will not function again. The side airbag system (including the seat) must be inspected and serviced by an authorized dealer.** If the airbag is not replaced, the unrepaired area will increase the risk of injury in a collision.

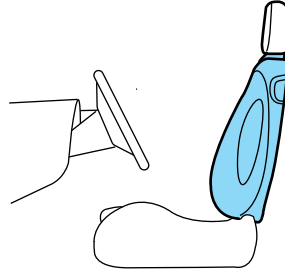

Determining if the system is operational

The SRS uses a readiness light in the instrument cluster or a tone to indicate the condition of the system. Refer to the *Warning lights and chimes* section in the *Instrument Cluster* chapter. Routine maintenance of the airbag is not required.

Any difficulty with the system is indicated by one or more of the following:

- The readiness light (same light as used for front airbag system) will either flash or stay lit.
- The readiness light will not illuminate immediately after ignition is turned to the on position.
- A series of five beeps will be heard. The tone pattern will repeat periodically until the problem and light are repaired.

If any of these things happen, even intermittently, have the SRS serviced at an authorized dealer immediately. Unless serviced, the system may not function properly in the event of a collision.

Seating and Safety Restraints

Safety Canopy® System

 **WARNING:** Do not place objects or mount equipment on or near the headliner at the siderail that may come into contact with a deploying Safety Canopy®. Failure to follow these instructions may increase the risk of personal injury in the event of a collision.

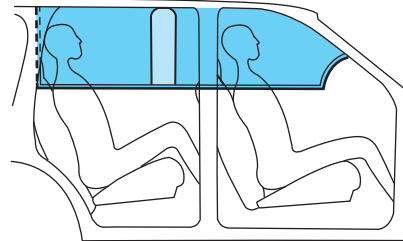

 **WARNING:** Do not lean your head on the door. The Safety Canopy® could injure you as it deploys from the headliner.

 **WARNING:** Do not attempt to service, repair, or modify the Safety Canopy® System, its fuses, the A, B, C or D pillar trim, or the headliner on a vehicle containing a Safety Canopy®. See your authorized dealer.

 **WARNING:** All occupants of the vehicle including the driver should always wear their safety belts even when an airbag SRS and Safety Canopy® System is provided.

 **WARNING:** To reduce risk of injury, do not obstruct or place objects in the deployment path of the inflatable Safety Canopy®.

Seating and Safety Restraints

How does the Safety Canopy® System work?

The design and development of the Safety Canopy System included recommended testing procedures that were developed by a group of automotive safety experts known as the Side Airbag Technical Working Group. These recommended testing procedures help reduce the risk of injuries related to the deployment of side airbags (including the Safety Canopy®).

The Safety Canopy System consists of the following:

- An inflatable curtain with a gas generator concealed behind the headliner and above the doors (one on each side of vehicle).
- A headliner designed to flex open above the side doors to allow safety canopy deployment.
- The same readiness airbag light, electronic control and diagnostic unit as used for the front airbags.
- Crash sensors mounted in each front door.
- Two crash sensors located at the C-pillar behind the rear doors (one on each side of the vehicle).
- Rollover sensor in the restraints control module (RCM).

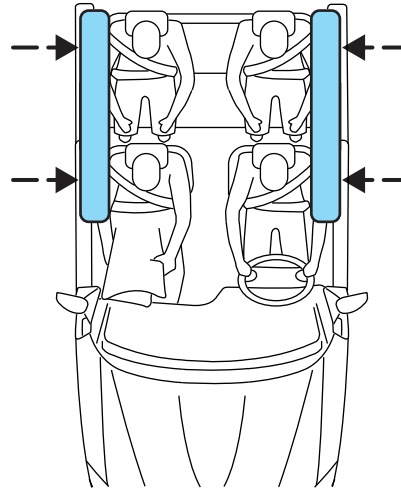

The Safety Canopy System, in combination with safety belts, can help reduce the risk of severe injuries in the event of a significant side impact collision or rollover event.

Children 12 years old and under should always be properly restrained in the second or third row seats. The safety canopy will not interfere with children restrained using a properly installed child or booster seat because it is designed to inflate downward from the headliner above the doors along the side window opening.

The Safety Canopy System is designed to activate when the vehicle sustains lateral deceleration sufficient to cause the side crash sensor to close an electrical circuit that initiates safety canopy inflation or when a certain likelihood of a rollover event is detected by the rollover sensor.

156

Seating and Safety Restraints

The safety canopy is mounted to roof side-rail sheet metal, behind the headliner, above each row of seats. In certain lateral collisions or rollover events, the Safety Canopy System will be activated, regardless of which seats are occupied. The safety canopy is designed to inflate between the side window area and occupants to further enhance protection provided in side impact collisions and rollover events.

The fact that the safety canopy did not activate in a collision does not mean that something is wrong with the system. Rather, it means the forces were not of the type sufficient to cause activation. The safety canopy is designed to inflate in certain side impact collisions or rollover events, not in rear impact, frontal or near-frontal collisions, unless the collision causes sufficient lateral deceleration or rollover.



WARNING: If the Safety Canopy System has deployed, the safety canopy will not function again unless replaced. The Safety Canopy System (including the A, B, C, and D pillar trim and headliner) must be inspected and serviced by an authorized dealer. If the safety canopy is not replaced, it will not function again, which will increase the risk of injury in a future collision.

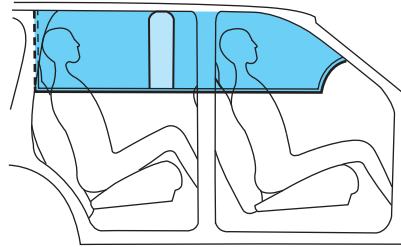

Seating and Safety Restraints

Determining if the system is operational

The SRS uses a readiness light in the instrument cluster or a tone to indicate the condition of the system. Refer to the *Airbag readiness* section in the *Instrument Cluster* chapter. Routine maintenance of the airbag is not required.

Any difficulty with the system is indicated by one or more of the following:

- The readiness airbag light (same light as for front airbag system) will either flash or stay lit.
- The readiness light will not illuminate immediately after ignition is turned on.
- A series of five beeps will be heard. The tone pattern will repeat periodically until the problem and light are repaired.

If any of these things happen, even intermittently, have the SRS serviced at your authorized dealer immediately. Unless serviced, the system may not function properly in the event of a collision or rollover event.

SOS Post-Crash Alert System™

The system automatically flashes the turn signal lamps and sounds the horn three times at four second intervals in the event of a serious impact that deploys an airbag (front, side, side curtain or Safety Canopy®) or the safety belt pretensioners.

The system can be turned off when any one of the following actions are taken by the driver or any other person:

- pressing the hazard control button,
- or pressing the panic button on the remote entry transmitter.

The feature will continue to operate until the vehicle runs out of power.

Disposal of airbags and airbag equipped vehicles (including pretensioners)

Contact your authorized dealer as soon as possible. Airbags MUST BE disposed of by qualified personnel.

SAFETY RESTRAINTS FOR CHILDREN

See the following sections for directions on how to properly use safety restraints for children. Also see *Airbag supplemental restraint system (SRS)* in this chapter for special instructions about using airbags.

Seating and Safety Restraints

Important child restraint precautions



WARNING: Always make sure your child is secured properly in a device that is appropriate for their height, age and weight. Child safety restraints must be purchased separately from the vehicle. Failure to follow these instructions and guidelines may result in an increased risk of serious injury or death to your child.



WARNING: All children are shaped differently. The Recommendations for Safety Restraints are based on probable child height, age and weight thresholds from NHTSA and other safety organizations or are the minimum requirements of law. Ford recommends checking with a NHTSA Certified Child Passenger Safety Technician (CPST) and consult your pediatrician to make sure your child seat is appropriate for your child, and is compatible with and properly installed in the vehicle. To locate a child seat fitting station and CPST contact the NHTSA toll free at 1-888-327-4236 or on the internet at <http://www.nhtsa.dot.gov>. In Canada, check with your local St. John Ambulance office for referral to a CPST or for further information, contact your provincial ministry of transportation, your local St. John Ambulance office at <http://www.sfa.ca>, or Transport Canada at 1-800-333-0371 (<http://www.tc.gc.ca>). Failure to properly restrain children in safety seats made especially for their height, age, and weight may result in an increased risk of serious injury or death to your child.

Seating and Safety Restraints

| Recommendations for Safety Restraints for Children | | |
|--|--|--|
| | Child size, height, weight, or age | Recommended restraint type |
| Infants or toddlers | Children weighing 40 lb (18 kg) or less (generally age four or younger) | Use a child safety seat (sometimes called an infant carrier, convertible seat, or toddler seat). |
| Small children | Children who have outgrown or no longer properly fit in a child safety seat (generally children who are less than 4 feet 9 inches (1.45 meters) tall, are greater than age four (4) and less than age twelve (12), and between 40 lb (18 kg) and 80 lb (36 kg) and upward to 100 lb (45 kg) if recommended by your child restraint manufacturer) | Use a belt-positioning booster seat. |
| Larger children | Children who have outgrown or no longer properly fit in a belt-positioning booster seat (generally children who are at least 4 feet 9 inches (1.45 meters) tall or greater than 80 lb (36 kg) or 100 lb (45 kg) if recommended by child restraint manufacturer) | Use a vehicle safety belt having the lap belt snug and low across the hips, shoulder belt centered across the shoulder and chest, and seat-back upright. |

- You are required by law to properly use safety seats for infants and toddlers in the U.S. and Canada.
- Many states and provinces require that small children use approved booster seats until they reach age eight, a height of 4 ft 9 in. (1.45 meters) tall, or 80 lb (36 kg). Check your local and state or provincial laws for specific requirements regarding the safety of children in your vehicle.
- When possible, always properly restrain children twelve (12) years of age and under in a rear seating position of your vehicle. Accident statistics suggest that children are safer when properly restrained in the rear seating positions than in a front seating position.

Seating and Safety Restraints

Recommendations for attaching child safety restraints for children

| Re-straint Type | Child Weight | Use any attachment method as indicated below by "X" | | | | |
|---------------------------|---------------------|---|----------------------------|-----------------------------------|---|------------------|
| | | LATCH (lower anchors and top tether anchor) | LATCH (lower anchors only) | Safety belt and top tether anchor | Safety belt and LATCH (lower anchors and top tether anchor) | Safety belt only |
| Rear facing child seat | Up to 48 lb (21 kg) | | X | | | X |
| Forward facing child seat | Up to 48 lb (21 kg) | X | | X | X | |
| Forward facing child seat | Over 48 lb (21 kg) | | | X | X | |

 **WARNING:** Airbags can kill or injure a child in a child seat. NEVER place a rear-facing child seat in front of an active airbag. If you must use a forward-facing child seat in the front seat, move the vehicle seat all the way back. When possible, all children age 12 and under should be properly restrained in a rear seating position. If all children cannot be seated and restrained properly in a rear seating position, properly restrain the largest child in the front seat.

 **WARNING:** Always carefully follow the instructions and warnings provided by the manufacturer of any child restraint to determine if the restraint device is appropriate for your child's size, height, weight, or age. Follow the child restraint manufacturer's instructions and warnings provided for installation and use in conjunction with the instructions and warnings provided by the vehicle manufacturer. A safety seat that is improperly installed or utilized, is inappropriate for your child's height, age, or weight or does not properly fit the child may increase the risk of serious injury or death.

Seating and Safety Restraints

 **WARNING:** Never let a passenger hold a child on his or her lap while the vehicle is moving. The passenger cannot protect the child from injury in a collision, which may result in serious injury or death.

 **WARNING:** Never use pillows, books, or towels to boost a child. They can slide around and increase the likelihood of injury or death in a collision.

 **WARNING:** Always restrain an unoccupied child seat or booster seat. These objects may become projectiles in a collision or sudden stop, which may increase the risk of serious injury.

 **WARNING:** Never place, or allow a child to place, the shoulder belt under a child's arm or behind the back because it reduces the protection for the upper part of the body and may increase the risk of injury or death in a collision.

 **WARNING:** Do not leave children, unreliable adults, or pets unattended in your vehicle.

Transporting children

Always make sure your child is secured properly in a device that is appropriate for their age, height and weight. All children are shaped differently. The child height, age and weight thresholds provided are recommendations or the minimum requirements of law. The National Highway Traffic Safety Administration (NHTSA) provides education and training to ensure that all children ages 0 to 16 are properly restrained in the correct restraint system. Ford recommends checking with a NHTSA Certified Child Passenger Safety Technician (CPST) and your pediatrician to make sure your seat is appropriate for your child and properly installed in the vehicle. To locate a child seat fitting station and CPST contact the NHTSA toll free at **1-888-327-4236** or on the internet at <http://www.nhtsa.dot.gov>. In Canada, check with your local St. John Ambulance office for referral to a CPST or for further information, contact your provincial ministry of transportation, your local St. John Ambulance office at <http://www.sfa.ca>, or Transport Canada at 1-800-333-0371 (<http://www.tc.gc.ca>).

162

Seating and Safety Restraints

Follow all the safety restraint and airbag precautions that apply to adult passengers in your vehicle.

If the child is the proper height, age, and weight (as specified by your child safety seat or booster manufacturer), fits the restraint and can be restrained properly, then restrain the child in the child safety seat or with the belt-positioning booster. Remember that child seats and belt-positioning boosters vary and may be designed to fit children of different heights, ages and weights. Children who are too large for child safety seats or belt-positioning boosters (as specified by your child safety seat manufacturer) should always properly wear safety belts.

SAFETY SEATS FOR CHILDREN

Infant and/or toddler seats

Use a safety seat that is recommended for the size and weight of the child.

When installing a child safety seat:

- Review and follow the information presented in the *Airbag supplemental restraint system (SRS)* section in this chapter.
- Carefully follow all of the manufacturer's instructions included with the safety seat you put in your vehicle. If you do not install and use the safety seat properly, the child may be injured in a sudden stop or collision.

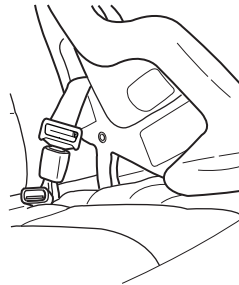

Airbags can kill or injure a child in a child seat. NEVER place a rear-facing child seat in front of an active airbag. If you must use a forward-facing child seat in the front seat, move the vehicle seat all the way back.

Children 12 and under should be properly restrained in a rear seating position whenever possible. If all children cannot be seated and restrained properly in a rear seating position, properly restrain the largest child in the front seat.

Installing child safety seats with combination lap and shoulder belts

Check to make sure the child seat is properly secured before each use. Children 12 and under should be properly restrained in a rear seating

Seating and Safety Restraints

position whenever possible. If all children cannot be seated and restrained properly in a rear seating position, properly restrain the largest child in the front seat.

When installing a child safety seat with combination lap/shoulder belts:

- Use the correct safety belt buckle for that seating position.
- Insert the belt tongue into the proper buckle until you hear a snap and feel it latch. Make sure the tongue is securely fastened in the buckle.
- Keep the buckle release button pointing up and away from the safety seat, with the tongue between the child seat and the release button, to help prevent accidental unbuckling.
- Place vehicle seat back in upright position.
- Put the safety belt in the automatic locking mode. Refer to Step 5 below. This vehicle does not require the use of a locking clip.



WARNING: Depending on where you secure a child restraint, and depending on the child restraint design, you may block access to certain safety belt buckle assemblies and/or LATCH lower anchors, rendering those features potentially unusable. To avoid risk of injury, occupants should only use seating positions where they are able to be properly restrained.

Perform the following steps when installing the child seat with combination lap/shoulder belts:

Note: Although the child seat illustrated is a forward facing child seat, the steps are the same for installing a rear facing child seat.

1. Position the child safety seat in a seat with a combination lap and shoulder belt.

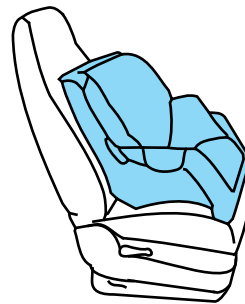

Seating and Safety Restraints

2. Pull down on the shoulder belt and then grasp the shoulder belt and lap belt together.

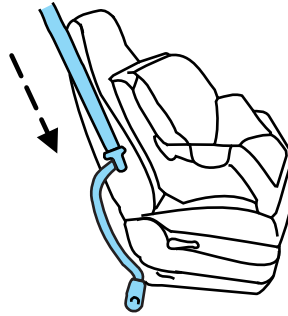

3. While holding the shoulder and lap belt portions together, route the tongue through the child seat according to the child seat manufacturer's instructions. Be sure the belt webbing is not twisted.

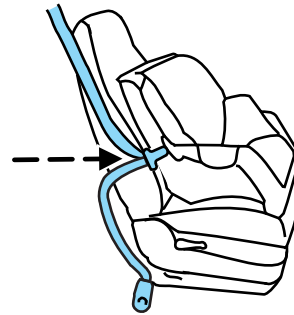

4. Insert the belt tongue into the proper buckle (the buckle closest to the direction the tongue is coming from) for that seating position until you hear a snap and feel the latch engage. Make sure the tongue is latched securely by pulling on it.

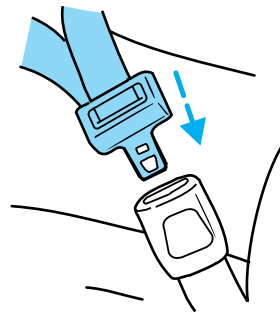

Seating and Safety Restraints

5. To put the retractor in the automatic locking mode, grasp the shoulder portion of the belt and pull downward until all of the belt is pulled out.

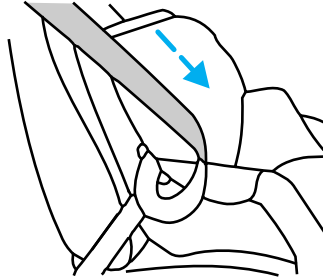

6. Allow the belt to retract to remove slack. The belt will click as it retracts to indicate it is in the automatic locking mode.

7. Try to pull the belt out of the retractor to make sure the retractor is in the automatic locking mode (you should not be able to pull more belt out). If the retractor is not locked, repeat Steps 5 and 6.

8. Remove remaining slack from the belt. Force the seat down with extra weight, e.g., by pressing down or kneeling on the child restraint while pulling up on the shoulder belt in order to force slack from the belt. This is necessary to remove the remaining slack that will exist once the additional weight of the child is added to the child restraint. It also helps to achieve the proper snugness of the child seat to the vehicle. Sometimes, a slight lean towards the buckle will additionally help to remove remaining slack from the belt.

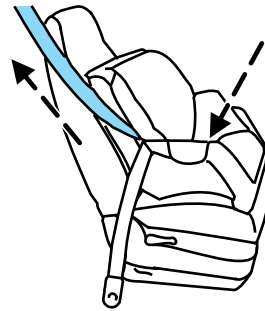

9. Attach the tether strap (if the child seat is equipped). Refer to *Attaching child safety seats with tether straps* later in this chapter.

Seating and Safety Restraints

10. Before placing the child in the seat, forcibly move the seat forward and back to make sure the seat is securely held in place. To check this, grab the seat at the belt path and attempt to move it side to side and forward and back. There should be no more than 1 inch (2.5 cm) of movement for proper installation.

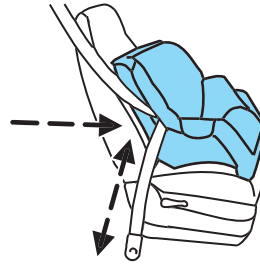

Ford recommends checking with a NHTSA Certified Child Passenger Safety Technician (CPST) to make certain the child restraint is properly installed. In Canada, check with your local St. John Ambulance office for referral to a CPST.

Attaching child safety seats with LATCH (Lower Anchors and Tethers for Children) attachments

The LATCH system is composed of three vehicle anchor points: two (2) lower anchors located where the vehicle seat back and seat cushion meet (called the “seat bight”) and one (1) top tether anchor located behind that seating position.

LATCH compatible child safety seats have two rigid or webbing mounted attachments that connect to the two lower anchors at the LATCH equipped seating positions in your vehicle. This type of attachment method eliminates the need to use safety belts to attach the child seat, however the safety belt can still be used to attach the child seat. For forward-facing child seats, the top tether strap must also be attached to the proper top tether anchor, if a top tether strap has been provided with your child seat. Ford Motor Company recommends the use of a child safety seat having a top tether strap. See *Attaching child safety seats with tether straps* and *Recommendations for attaching safety restraints for children* in this chapter for more information.

Seating and Safety Restraints

Your vehicle has LATCH lower anchors for child seat installation at the seating positions marked with the child seat symbol.

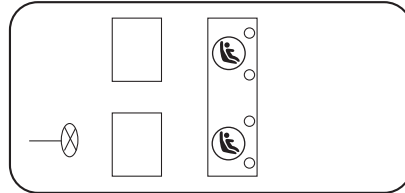

The LATCH anchors are located at the rear section of the rear seat between the cushion and seat back, below the locator symbols on the seat back. Follow the child seat manufacturer's instructions to properly install a child seat with LATCH attachments.

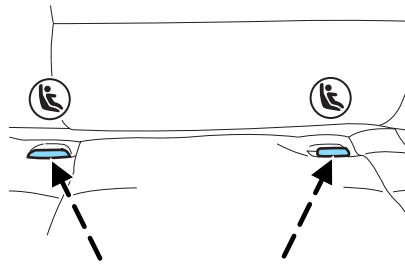

Follow the instructions on attaching child safety seats with tether straps. Refer to *Attaching child safety seats with tether straps* later in this chapter.

Attach LATCH lower attachments of the child seat only to the anchors shown.

WARNING: Never attach two child safety seats to the same anchor. In a crash, one anchor may not be strong enough to hold two child safety seat attachments and may break, causing serious injury or death.

WARNING: Depending on where you secure a child restraint, and depending on the child restraint design, you may block access to certain safety belt buckle assemblies and/or LATCH lower anchors, rendering those features potentially unusable. To avoid risk of injury, occupants should only use seating positions where they are able to be properly restrained.

Seating and Safety Restraints

Use of inboard lower anchors from the outboard seating positions (center seating use)

The lower anchors at the center of the second row rear seat are spaced 460 mm (18 inches) apart. The standardized spacing for LATCH lower anchors is 280 mm (11 inches) center to center. A child seat with rigid LATCH attachments cannot be installed at the center seating position. LATCH compatible child seats (with attachments on belt webbing) can only be used at this seating position provided that the child seat manufacturer's instructions permit use with the anchor spacing stated. Do not attach a child seat to any lower anchor if an adjacent child seat is attached to that anchor.



WARNING: The standardized spacing for LATCH lower anchors is 280 mm (11 inches) center to center. Do not use LATCH lower anchors for the center seating position unless the child seat manufacturer's instructions permit and specify using anchors spaced at least as far apart as those in this vehicle.

Each time you use the safety seat, check that the seat is properly attached to the lower anchors and tether anchor, if applicable. Tug the child seat from side to side and forward and back where it is secured to the vehicle. The seat should move less than one inch when you do this for a proper installation.

If the safety seat is not anchored properly, the risk of a child being injured in a crash greatly increases.

Combining safety belt and LATCH lower anchors for attaching child safety seats

When used in combination, either the safety belt or the LATCH lower anchors may be attached first, provided a proper installation is achieved. Attach the tether strap afterward, if included with the child seat. Refer to *Recommendations for attaching child safety restraints for children* in this chapter.

Attaching child safety seats with tether straps

Many forward-facing child safety seats include a tether strap which extends from the back of the child safety seat and hooks to an anchoring point called the top tether anchor. Tether straps are available as an accessory for many older safety seats. Contact the manufacturer of your child seat for information about ordering a tether strap, or to obtain a longer tether strap if the tether strap on your safety seat does not reach the appropriate top tether anchor in the vehicle.

169

Seating and Safety Restraints

The rear seats of your vehicle are equipped with built-in tether strap anchors located behind the seats as described below.

The tether anchors in your vehicle are located under the second row seat gap cover marked with tether anchor symbols (shown with title).

The tether strap anchors in your vehicle are in the following positions (shown from top view):

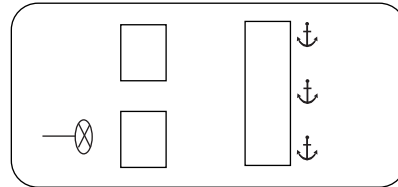

WARNING: Attach the tether strap only to the appropriate tether anchor as shown. The tether strap may not work properly if attached somewhere other than the correct tether anchor.



WARNING: Do not use seat anchors as cargo tie downs.

Once the child safety seat has been installed, using either the safety belt, the lower anchors of the LATCH system, or both, you can attach the top tether strap.

If you install a child seat with rigid LATCH attachments, and have attached the top tether strap to the proper top tether anchor, do not tighten the tether strap enough to lift the child seat off the vehicle seat cushion when the child is seated in it. Keep the tether strap just snug without lifting the front of the child seat. Keeping the child seat just touching the vehicle seat gives the best protection in a severe crash.

Perform the following steps to attach a child safety seat to the tether anchor:

1. Route the child safety seat tether strap over the back of the seat.

For vehicles with adjustable head restraints, route the tether strap under the head restraint and between the head restraint posts, , otherwise route the tether strap over the top of the head restraint. If the top of the safety seat hits the adjustable head restraint, raise the head restraint to let the child seat fit further rearward.

Seating and Safety Restraints

2. Locate the correct anchor behind the gap cover for the selected seating position.

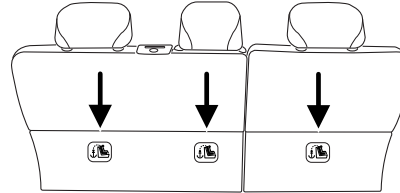

3. Clip the tether strap to the anchor as shown.



WARNING: If the tether strap is clipped incorrectly, the child safety seat may not be retained properly in the event of a collision.

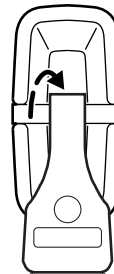

4. Tighten the child safety seat tether strap according to the manufacturer's instructions.



WARNING: If the safety seat is not anchored properly, the risk of a child being injured in a collision greatly increases.

If your child restraint system is equipped with a tether strap, and the child restraint manufacturer recommends its use, Ford also recommends its use.

Child booster seats

The belt-positioning booster (booster seat) is used to improve the fit of the vehicle safety belt. Children outgrow a typical child seat (e.g., convertible or toddler seat) when they weigh about 40 lb (18 kg) and are around four (4) years of age. Consult your child safety seat owner guide for the weight, height, and age limits specific to your child safety seat. Keep your child in the child safety seat if it properly fits the child, remains appropriate for their weight, height and age AND if properly secured to the vehicle.

Although the lap/shoulder belt will provide some protection, children who have outgrown a typical child seat are still too small for lap/shoulder belts to fit properly, and wearing an improperly fitted vehicle safety belt could increase the risk of serious injury in a crash. To improve the fit of

171

Seating and Safety Restraints

both the lap and shoulder belt on children who have outgrown child safety seats, Ford Motor Company recommends use of a belt-positioning booster.

Booster seats position a child so that vehicle lap/shoulder safety belts fit better. They lift the child up so that the lap belt rests low across the hips and the knees bend comfortably at the edge of the cushion, while minimizing slouching. Booster seats may also make the shoulder belt fit better and more comfortably. Try to keep the belt near the middle of the shoulder and across the center of the chest. Moving the child closer (a few centimeters or inches) to the center of the vehicle, but remaining in the same seating position, may help provide a good shoulder belt fit.

When children should use booster seats

Children need to use booster seats from the time they outgrow the toddler seat until they are big enough for the vehicle seat and lap/shoulder belt to fit properly. Generally this is when they reach a height of at least 4 feet 9 inches (1.45 meters) tall (around age eight to age twelve and between 40 lb (18 kg) and 80 lb (36 kg) or upward to 100 lb (45 kg) if recommended by your child restraint manufacturer). Many state and provincial laws require that children use approved booster seats until they reach age eight, a height of 4 feet 9 inches (1.45 meters) tall, or 80 lb (36 kg).

Booster seats should be used until you can answer YES to ALL of these questions when seated without a booster seat:

- Can the child sit all the way back against the vehicle seat back with knees bent comfortably at the edge of the seat cushion?
- Can the child sit without slouching?

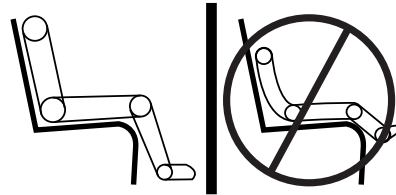

- Does the lap belt rest low across the hips?
- Is the shoulder belt centered on the shoulder and chest?
- Can the child stay seated like this for the whole trip?

Seating and Safety Restraints

Types of booster seats

There are generally two types of belt-positioning booster seats: backless and high back. Always use booster seats in conjunction with the vehicle lap/shoulder belt.

- **Backless booster seats**

If your backless booster seat has a removable shield, remove the shield. If a vehicle seating position has a low seat back or no head restraint, a backless booster seat may place your child's head (as measured at the tops of the ears) above the top of the seat. In this case, move the backless booster to another seating position with a higher seat back or head restraint and lap/shoulder belts, or consider using a high back booster seat.



- **High back booster seats**

If, with a backless booster seat, you cannot find a seating position that adequately supports your child's head, a high back booster seat would be a better choice.



Seating and Safety Restraints

Children and booster seats vary in size and shape. Choose a booster that keeps the lap belt low and snug across the hips, never up across the stomach, and lets you adjust the shoulder belt to cross the chest and rest snugly near the center of the shoulder. The drawings below compare the ideal fit (center) to a shoulder belt uncomfortably close to the neck and a shoulder belt that could slip off the shoulder. The drawings below also show how the lap belt should be low and snug across the child's hips.

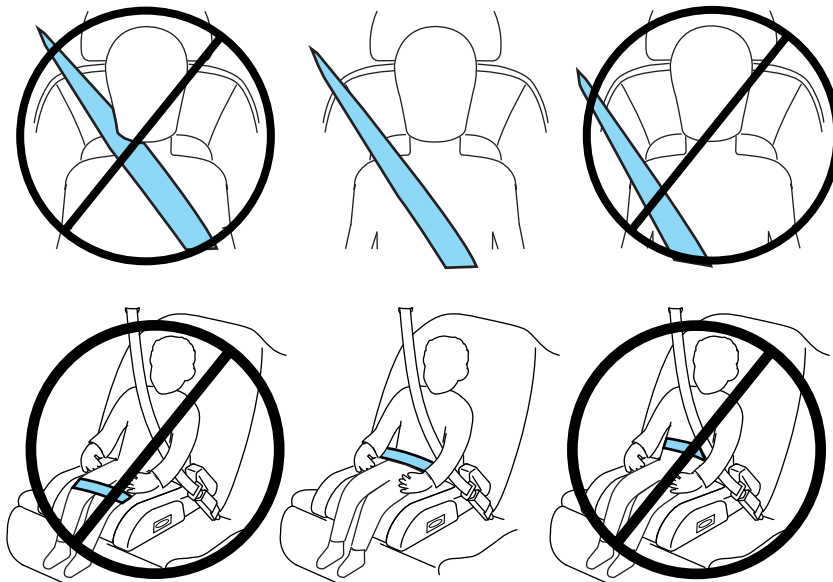

If the booster seat slides on the vehicle seat, placing a rubberized mesh sold as shelf or carpet liner under the booster seat may improve this condition. Do not introduce any item thicker than this under the booster seat. Check with the booster seat manufacturer's instructions.

The importance of shoulder belts

Using a booster without a shoulder belt increases the risk of a child's head hitting a hard surface in a collision. For this reason, you should never use a booster seat with a lap belt only. It is generally best to use a booster seat with lap/shoulder belts in the back seat.

Move a child to a different seating location if the shoulder belt does not stay positioned on the shoulder during use.

174

Seating and Safety Restraints

Follow all instructions provided by the manufacturer of the booster seat.



WARNING: Never place, or allow a child to place, the shoulder belt under a child's arm or behind the back because it reduces the protection for the upper part of the body and may increase the risk of injury or death in a collision.

Child restraint and safety belt maintenance

Inspect the vehicle safety belts and child safety seat systems periodically to make sure they work properly and are not damaged. Inspect the vehicle and child seat safety belts to make sure there are no nicks, tears or cuts. Replace if necessary. All vehicle safety belt assemblies, including retractors, buckles, front safety belt buckle assemblies, buckle support assemblies (slide bar-if equipped), shoulder belt height adjusters (if equipped), shoulder belt guide on seatback (if equipped), child safety seat LATCH and tether anchors, and attaching hardware, should be inspected after a collision. Refer to the child restraint manufacturer's instructions for additional inspection and maintenance information specific to the child restraint. Ford Motor Company recommends that all safety belt assemblies in use in vehicles involved in a collision be replaced. However, if the collision was minor and an authorized dealer finds that the belts do not show damage and continue to operate properly, they do not need to be replaced. Safety belt assemblies not in use during a collision should also be inspected and replaced if either damage or improper operation is noted.

For proper care of soiled safety belts, refer to *Interior* in the *Cleaning* chapter.



WARNING: Failure to inspect and if necessary replace the safety belt assembly or child restraint system under the above conditions could result in severe personal injuries in the event of a collision.

Tires, Wheels and Loading

NOTICE TO CROSSOVER VEHICLE OWNERS

Crossover vehicles handle differently than passenger cars in the various driving conditions that are encountered on streets, highways and off-road. Crossover vehicles are not designed for cornering at speeds as high as passenger cars any more than low-slung sports cars are designed to perform satisfactorily under off-road conditions.

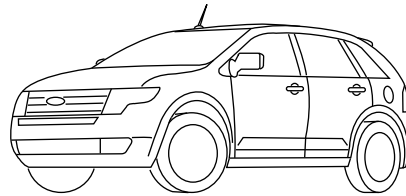

! **WARNING:** Crossover vehicles have a significantly higher rollover rate than other types of vehicles. To reduce the risk of serious injury or death from a rollover or other crash you must:

- Avoid sharp turns and abrupt maneuvers;
- Drive at safe speeds for the conditions;
- Keep tires properly inflated;
- Never overload or improperly load your vehicle; and
- Make sure every passenger is properly restrained.

! **WARNING:** In a rollover crash, an unbelted person is significantly more likely to die than a person wearing a seat belt. All occupants must wear seat belts and children/infants must use appropriate restraints to minimize the risk of injury or ejection.

Study your Owner's Guide for specific information about equipment features, instructions for safe driving and additional precautions to reduce the risk of an accident or serious injury.

VEHICLE CHARACTERISTICS

All-wheel drive (AWD) system (if equipped)

Your vehicle may be equipped with a full-time all-wheel drive (AWD) system. With the AWD option, power will be delivered to the front wheels and distributed to the rear wheels as needed. This increases traction which may enable you to safely drive over terrain and road conditions that a conventional two-wheel drive vehicle cannot. The AWD system is active all the time and requires no input from the operator.

Note: Your AWD vehicle is not intended for off-road use. The AWD feature gives your vehicle some limited off-road capabilities in which

176

Tires, Wheels and Loading

driving surfaces are relatively level, obstruction-free and otherwise similar to normal on-road driving conditions. Operating your vehicle under other than those conditions could subject the vehicle to excessive stress which might result in damage which is not covered under your warranty.

For AWD vehicles, a spare tire of a different size other than the tire provided should never be used. A dissimilar spare tire size (other than the spare tire provided) or major dissimilar tire sized between the front and rear axles could cause the AWD system to stop functioning and default to front-wheel drive.



WARNING: Do not become overconfident in the ability of AWD vehicles. Although a AWD vehicle may accelerate better than two-wheel drive vehicle in low traction situations, it won't stop any faster than two-wheel drive vehicles. Always drive at a safe speed.

How your vehicle differs from other vehicles

Crossover vehicles can differ from some other vehicles in a few noticeable ways. Your vehicle may be:

- Higher – to allow higher load carrying capacity.
- Shorter – to give it the capability to approach inclines. All other things held equal, a shorter wheelbase may make your vehicle quicker to respond to steering inputs than a vehicle with a longer wheelbase.
- Narrower — to provide greater maneuverability in tight spaces.

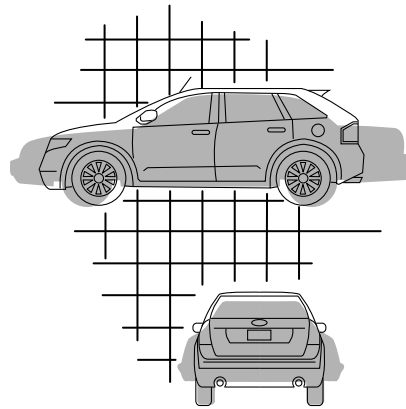

As a result of the above dimensional differences, crossover vehicles often will have a higher center of gravity and a greater difference in center of gravity between the loaded and unloaded condition.

These differences that make your vehicle so versatile also make it handle differently than an ordinary passenger car.

Tires, Wheels and Loading

INFORMATION ABOUT UNIFORM TIRE QUALITY GRADING

Tire Quality Grades apply to new pneumatic passenger car tires. The Quality grades can be found where applicable on the tire sidewall between tread shoulder and maximum section width. For example:

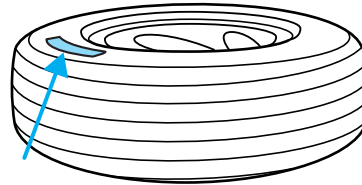

- **Treadwear 200 Traction AA Temperature A**

These Tire Quality Grades are determined by standards that the United States Department of Transportation has set.

Tire Quality Grades apply to new pneumatic passenger car tires. They do not apply to deep tread, winter-type snow tires, space-saver or temporary use spare tires, light truck or "LT" type tires, tires with nominal rim diameters of 10 to 12 inches or limited production tires as defined in Title 49 Code of Federal Regulations Part 575.104(c)(2).

U.S. Department of Transportation-Tire quality grades: The U.S. Department of Transportation requires Ford Motor Company to give you the following information about tire grades exactly as the government has written it.

Treadwear

The treadwear grade is a comparative rating based on the wear rate of the tire when tested under controlled conditions on a specified government test course. For example, a tire graded 150 would wear one and one-half (1½) times as well on the government course as a tire graded 100. The relative performance of tires depends upon the actual conditions of their use, however, and may depart significantly from the norm due to variations in driving habits, service practices, and differences in road characteristics and climate.

Traction AA A B C

The traction grades, from highest to lowest are AA, A, B, and C. The grades represent the tire's ability to stop on wet pavement as measured under controlled conditions on specified government test surfaces of asphalt and concrete. A tire marked C may have poor traction performance.

178

Tires, Wheels and Loading



WARNING: The traction grade assigned to this tire is based on straight-ahead braking traction tests, and does not include acceleration, cornering, hydroplaning or peak traction characteristics.

Temperature A B C

The temperature grades are A (the highest), B and C, representing the tire's resistance to the generation of heat and its ability to dissipate heat when tested under controlled conditions on a specified indoor laboratory test wheel. Sustained high temperature can cause the material of the tire to degenerate and reduce tire life, and excessive temperature can lead to sudden tire failure. The grade C corresponds to a level of performance which all passenger car tires must meet under the Federal Motor Vehicle Safety Standard No. 139. Grades B and A represent higher levels of performance on the laboratory test wheel than the minimum required by law.



WARNING: The temperature grade for this tire is established for a tire that is properly inflated and not overloaded. Excessive speed, underinflation, or excessive loading, either separately or in combination, can cause heat buildup and possible tire failure.

TIRES

Tires are designed to give many thousands of miles of service, but they must be maintained in order to get the maximum benefit from them.

Glossary of tire terminology

- **Tire label:** A label showing the OE (Original Equipment) tire sizes, recommended inflation pressure and the maximum weight the vehicle can carry.
- **Tire Identification Number (TIN):** A number on the sidewall of each tire providing information about the tire brand and manufacturing plant, tire size and date of manufacture. Also referred to as DOT code.
- **Inflation pressure:** A measure of the amount of air in a tire.
- **Standard load:** A class of P-metric or Metric tires designed to carry a maximum load at 35 psi [37 psi (2.5 bar) for Metric tires]. Increasing the inflation pressure beyond this pressure will not increase the tire's load carrying capability.

179

Tires, Wheels and Loading

- **Extra load:** A class of P-metric or Metric tires designed to carry a heavier maximum load at 41 psi [43 psi (2.9 bar) for Metric tires]. Increasing the inflation pressure beyond this pressure will not increase the tire's load carrying capability.
- **kPa:** Kilopascal, a metric unit of air pressure.
- **PSI:** Pounds per square inch, a standard unit of air pressure.
- **Cold inflation pressure:** The tire pressure when the vehicle has been stationary and out of direct sunlight for an hour or more and prior to the vehicle being driven for 1 mile (1.6 km).
- **Recommended inflation pressure:** The cold inflation pressure found on the Safety Compliance Certification Label or Tire Label located on the B-Pillar or the edge of the driver's door.
- **B-pillar:** The structural member at the side of the vehicle behind the front door.
- **Bead area of the tire:** Area of the tire next to the rim.
- **Sidewall of the tire:** Area between the bead area and the tread.
- **Tread area of the tire:** Area of the perimeter of the tire that contacts the road when mounted on the vehicle.
- **Rim:** The metal support (wheel) for a tire or a tire and tube assembly upon which the tire beads are seated.

INFLATING YOUR TIRES

Safe operation of your vehicle requires that your tires are properly inflated. Remember that a tire can lose up to half of its air pressure without appearing flat.

Every day before you drive, check your tires. If one looks lower than the others, use a tire gauge to check pressure of all tires and adjust if required.

At least once a month and before long trips, inspect each tire and check the tire pressure with a tire gauge (including spare, if equipped). Inflate all tires to the inflation pressure recommended by Ford Motor Company.

You are strongly urged to buy a reliable tire pressure gauge, as automatic service station gauges may be inaccurate. Ford recommends the use of a digital or dial-type tire pressure gauge rather than a stick-type tire pressure gauge.

Use the recommended cold inflation pressure for optimum tire performance and wear. Under-inflation or over-inflation may cause uneven treadwear patterns.

180

Tires, Wheels and Loading



WARNING: Under-inflation is the most common cause of tire failures and may result in severe tire cracking, tread separation or “blowout”, with unexpected loss of vehicle control and increased risk of injury. Under-inflation increases sidewall flexing and rolling resistance, resulting in heat buildup and internal damage to the tire. It also may result in unnecessary tire stress, irregular wear, loss of vehicle control and accidents. A tire can lose up to half of its air pressure and not appear to be flat!

Always inflate your tires to the Ford recommended inflation pressure even if it is less than the maximum inflation pressure information found on the tire. The Ford recommended tire inflation pressure is found on the Safety Compliance Certification Label or Tire Label which is located on the B-Pillar or the edge of the driver's door. Failure to follow the tire pressure recommendations can cause uneven treadwear patterns and adversely affect the way your vehicle handles.

Maximum Permissible Inflation Pressure is the tire manufacturer's maximum permissible pressure and/or the pressure at which the maximum load can be carried by the tire. This pressure is normally higher than the manufacturer's recommended cold inflation pressure which can be found on the Safety Compliance Certification Label or Tire Label which is located on the B-Pillar or the edge of the driver's door. The cold inflation pressure should never be set lower than the recommended pressure on the Safety Compliance Certification Label or Tire Label.

When weather temperature changes occur, tire inflation pressures also change. A 10°F (6°C) temperature drop can cause a corresponding drop of 1 psi (7 kPa) in inflation pressure. Check your tire pressures frequently and adjust them to the proper pressure which can be found on the Safety Compliance Certification Label or Tire Label.

To check the pressure in your tire(s):

1. Make sure the tires are cool, meaning they are not hot from driving even a mile.

If you are checking tire pressure when the tire is hot, (i.e. driven more than 1 mile [1.6 km]), never “bleed” or reduce air pressure. The tires are hot from driving and it is normal for pressures to increase above recommended cold pressures. A hot tire at or below recommended cold inflation pressure could be significantly under-inflated.

Tires, Wheels and Loading

Note: If you have to drive a distance to get air for your tire(s), check and record the tire pressure first and add the appropriate air pressure when you get to the pump. It is normal for tires to heat up and the air pressure inside to go up as you drive.

2. Remove the cap from the valve on one tire, then firmly press the tire gauge onto the valve and measure the pressure.

3. Add enough air to reach the recommended air pressure.

Note: If you overfill the tire, release air by pressing on the metal stem in the center of the valve. Then recheck the pressure with your tire gauge.

4. Replace the valve cap.

5. Repeat this procedure for each tire, including the spare.

Note: Some spare tires operate at a higher inflation pressure than the other tires. For T-type/mini-spare tires (see the *Dissimilar spare tire/wheel information* section for description): Store and maintain at 60 psi (4.15 bar). For full-size and dissimilar spare tires (see the *Dissimilar spare tire/wheel information* section for description): Store and maintain at the higher of the front and rear inflation pressure as shown on the Tire Label.

6. Visually inspect the tires to make sure there are no nails or other objects embedded that could poke a hole in the tire and cause an air leak.

7. Check the sidewalls to make sure there are no gouges, cuts or bulges.

TIRE CARE

Inspecting your tires and wheel valve stems

Periodically inspect the tire treads for uneven or excessive wear and remove objects such as stones, nails or glass that may be wedged in the tread grooves. Check the tire and valve stems for holes, cracks, or cuts that may permit air leakage and repair or replace the tire and replace the valve stem. Inspect the tire sidewalls for cracking, cuts, bruises and other signs of damage or excessive wear. If internal damage to the tire is suspected, have the tire demounted and inspected in case it needs to be repaired or replaced. For your safety, tires that are damaged or show signs of excessive wear should not be used because they are more likely to blow out or fail.

Tires, Wheels and Loading

Improper or inadequate vehicle maintenance can cause tires to wear abnormally. Inspect all your tires, including the spare, frequently, and replace them if one or more of the following conditions exist:

Tire wear

When the tread is worn down to 1/16th of an inch (2 mm), tires must be replaced to help prevent your vehicle from skidding and hydroplaning. Built-in treadwear indicators, or “wear bars”, which look like narrow strips of smooth rubber across the tread will appear on the tire when the tread is worn down to 1/16th of an inch (2 mm). When the tire tread wears down to the same height as these “wear bars”, the tire is worn out and must be replaced.

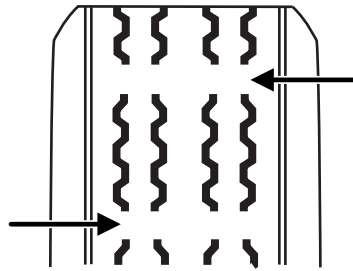

Damage

Periodically inspect the tire treads and sidewalls for damage (such as bulges in the tread or sidewalls, cracks in the tread groove and separation in the tread or sidewall). If damage is observed or suspected have the tire inspected by a tire professional. Tires can be damaged during off-road use, so inspection after off-road use is also recommended.



WARNING: Age

Tires degrade over time depending on many factors such as weather, storage conditions, and conditions of use (load, speed, inflation pressure, etc.) the tires experience throughout their lives. In general, tires should be replaced after six years regardless of tread wear. However, heat caused by hot climates or frequent high loading conditions can accelerate the aging process and may require tires to be replaced more frequently.

You should replace your spare tire when you replace the road tires or after six years due to aging even if it has not been used.

Tires, Wheels and Loading

U.S. DOT Tire Identification Number (TIN)

Both U.S. and Canada Federal regulations require tire manufacturers to place standardized information on the sidewall of all tires. This information identifies and describes the fundamental characteristics of the tire and also provides a U.S. DOT Tire Identification Number for safety standard certification and in case of a recall.

This begins with the letters "DOT" and indicates that the tire meets all federal standards. The next two numbers or letters are the plant code designating where it was manufactured, the next two are the tire size code and the last four numbers represent the week and year the tire was built. For example, the numbers 317 mean the 31st week of 1997. After 2000 the numbers go to four digits. For example, 2501 means the 25th week of 2001. The numbers in between are identification codes used for traceability. This information is used to contact customers if a tire defect requires a recall.

Tire replacement requirements

Your vehicle is equipped with tires designed to provide a safe ride and handling capability.



WARNING: Only use replacement tires and wheels that are the same size, load index, speed rating and type (such as P-metric versus LT-metric or all-season versus all-terrain) as those originally provided by Ford. The recommended tire and wheel size may be found on either the Safety Compliance Certification Label or the Tire Label which is located on the B-Pillar or edge of the driver's door. If this information is not found on these labels then you should contact your authorized dealer as soon as possible. Use of any tire or wheel not recommended by Ford can affect the safety and performance of your vehicle, which could result in an increased risk of loss of vehicle control, vehicle rollover, personal injury and death. Additionally the use of non-recommended tires and wheels could cause steering, suspension, axle or transfer case/power transfer unit failure. If you have questions regarding tire replacement, contact your authorized dealer as soon as possible.

Tires, Wheels and Loading



WARNING: When mounting replacement tires and wheels, you should not exceed the maximum pressure indicated on the sidewall of the tire to set the beads without additional precautions listed below. If the beads do not seat at the maximum pressure indicated, re-lubricate and try again.

When inflating the tire for mounting pressures up to 20 psi (1.38 bar) greater than the maximum pressure on the tire sidewall, the following precautions must be taken to protect the person mounting the tire:

1. Make sure that you have the correct tire and wheel size.
2. Lubricate the tire bead and wheel bead seat area again.
3. Stand at a minimum of 12 ft (3.66 m) away from the tire wheel assembly.
4. Use both eye and ear protection.

For a mounting pressure more than 20 psi (1.38 bar) greater than the maximum pressure, a Ford dealer or other tire service professional should do the mounting.

Always inflate steel carcass tires with a remote air fill with the person inflating standing at a minimum of 12 ft (3.66 m) away from the tire wheel assembly.

Important: Remember to replace the wheel valve stems when the road tires are replaced on your vehicle.

It is recommended that the two front tires or two rear tires generally be replaced as a pair.

The tire pressure sensors mounted in the wheels (originally installed on your vehicle) are not designed to be used in aftermarket wheels.

The use of wheels or tires not recommended by Ford Motor Company may affect the operation of your tire pressure monitoring system.

If the TPMS indicator is flashing, your TPMS is malfunctioning. Your replacement tire might be incompatible with your TPMS, or some component of the TPMS may be damaged.

Safety practices

Driving habits have a great deal to do with your tire mileage and safety.

- Observe posted speed limits
- Avoid fast starts, stops and turns
- Avoid potholes and objects on the road

Tires, Wheels and Loading

- Do not run over curbs or hit the tire against a curb when parking



WARNING: If your vehicle is stuck in snow, mud, sand, etc., **do not** rapidly spin the tires; spinning the tires can tear the tire and cause an explosion. A tire can explode in as little as three to five seconds.



WARNING: Do not spin the wheels at over 35 mph (56 km/h). The tires may fail and injure a passenger or bystander.

Highway hazards

No matter how carefully you drive there's always the possibility that you may eventually have a flat tire on the highway. Drive slowly to the closest safe area out of traffic. This may further damage the flat tire, but your safety is more important.

If you feel a sudden vibration or ride disturbance while driving, or you suspect your tire or vehicle has been damaged, immediately reduce your speed. Drive with caution until you can safely pull off the road. Stop and inspect the tires for damage. If a tire is under-inflated or damaged, deflate it, remove wheel and replace it with your spare tire and wheel. If you cannot detect a cause, have the vehicle towed to the nearest repair facility or tire dealer to have the vehicle inspected.

Tire and wheel alignment

A bad jolt from hitting a curb or pothole can cause the front end of your vehicle to become misaligned or cause damage to your tires. If your vehicle seems to pull to one side when you're driving, the wheels may be out of alignment. Have an authorized dealer check the wheel alignment periodically.

Wheel misalignment in the front or the rear can cause uneven and rapid treadwear of your tires and should be corrected by an authorized dealer. Front-wheel drive (FWD) vehicles and those with an independent rear suspension (if equipped) may require alignment of all four wheels.

The tires should also be balanced periodically. An unbalanced tire and wheel assembly may result in irregular tire wear.

Tire rotation

Rotating your tires at the recommended interval (as indicated in the *Scheduled Maintenance Guide* chapter) will help your tires wear more evenly, providing better tire performance and longer tire life.

186

Tires, Wheels and Loading

- Front-wheel drive (FWD)/All-wheel drive (AWD) vehicles (front tires at top of diagram)

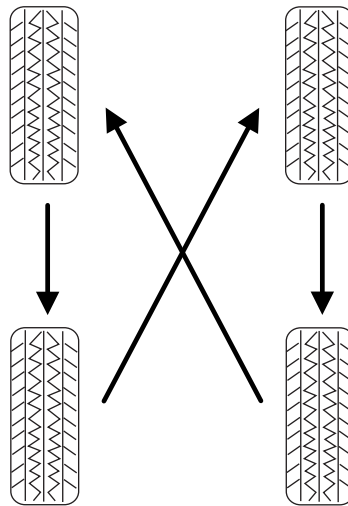

Sometimes irregular tire wear can be corrected by rotating the tires.

Note: If your tires show uneven wear ask an authorized dealer to check for and correct any wheel misalignment, tire imbalance or mechanical problem involved before tire rotation.

Note: Your vehicle may be equipped with a dissimilar spare tire/wheel. A dissimilar spare tire/wheel is defined as a spare tire and/or wheel that is different in brand, size or appearance from the road tires and wheels. If you have a dissimilar spare tire/wheel it is intended for temporary use only and should not be used in a tire rotation.

Note: After having your tires rotated, inflation pressure must be checked and adjusted to the vehicle requirements.

INFORMATION CONTAINED ON THE TIRE SIDEWALL

Both U.S. and Canada Federal regulations require tire manufacturers to place standardized information on the sidewall of all tires. This information identifies and describes the fundamental characteristics of the tire and also provides a U.S. DOT Tire Identification Number for safety standard certification and in case of a recall.

Tires, Wheels and Loading

Information on “P” type tires

P215/65R15 95H is an example of a tire size, load index and speed rating. The definitions of these items are listed below. (Note that the tire size, load index and speed rating for your vehicle may be different from this example.)

1. **P:** Indicates a tire, designated by the Tire and Rim Association (T&RA), that may be used for service on cars, SUVs, minivans and light trucks.

Note: If your tire size does not begin with a letter this may mean it is designated by either ETRTO (European Tire and Rim Technical Organization) or JATMA (Japan Tire Manufacturing Association).

2. **215:** Indicates the nominal width of the tire in millimeters from sidewall edge to sidewall edge. In general, the larger the number, the wider the tire.

3. **65:** Indicates the aspect ratio which gives the tire’s ratio of height to width.

4. **R:** Indicates a “radial” type tire.

5. **15:** Indicates the wheel or rim diameter in inches. If you change your wheel size, you will have to purchase new tires to match the new wheel diameter.

6. **95:** Indicates the tire’s load index. It is an index that relates to how much weight a tire can carry. You may find this information in your Owner’s Guide. If not, contact a local tire dealer.

Note: You may not find this information on all tires because it is not required by federal law.

7. **H:** Indicates the tire’s speed rating. The speed rating denotes the speed at which a tire is designed to be driven for extended periods of time under a standard condition of load and inflation pressure. The tires on your vehicle may operate at different conditions for load and inflation pressure. These speed ratings may need to be adjusted for the difference in conditions. The ratings range from 81 mph (130 km/h) to 186 mph (299 km/h). These ratings are listed in the following chart.



188

Tires, Wheels and Loading

Note: You may not find this information on all tires because it is not required by federal law.

| Letter rating | Speed rating - mph (km/h) |
|---------------|---------------------------|
| M | 81 mph (130 km/h) |
| N | 87 mph (140 km/h) |
| Q | 99 mph (159 km/h) |
| R | 106 mph (171 km/h) |
| S | 112 mph (180 km/h) |
| T | 118 mph (190 km/h) |
| U | 124 mph (200 km/h) |
| H | 130 mph (210 km/h) |
| V | 149 mph (240 km/h) |
| W | 168 mph (270 km/h) |
| Y | 186 mph (299 km/h) |

Note: For tires with a maximum speed capability over 149 mph (240 km/h), tire manufacturers sometimes use the letters ZR. For those with a maximum speed capability over 186 mph (299 km/h), tire manufacturers always use the letters ZR.

8. U.S. DOT Tire Identification Number (TIN): This begins with the letters "DOT" and indicates that the tire meets all federal standards. The next two numbers or letters are the plant code designating where it was manufactured, the next two are the tire size code and the last four numbers represent the week and year the tire was built. For example, the numbers 317 mean the 31st week of 1997. After 2000 the numbers go to four digits. For example, 2501 means the 25th week of 2001. The numbers in between are identification codes used for traceability. This information is used to contact customers if a tire defect requires a recall.

9. M+S or M/S: Mud and Snow, or

AT: All Terrain, or

AS: All Season.

10. Tire Ply Composition and Material Used: Indicates the number of plies or the number of layers of rubber-coated fabric in the tire tread and sidewall. Tire manufacturers also must indicate the ply materials in the tire and the sidewall, which include steel, nylon, polyester, and others.

11. Maximum Load: Indicates the maximum load in kilograms and pounds that can be carried by the tire. Refer to the Safety Compliance Certification Label, which is located on the B-Pillar or the edge of the driver's door, for the correct tire pressure for your vehicle.

Tires, Wheels and Loading

12. Treadwear, Traction and Temperature Grades

- **Treadwear:** The treadwear grade is a comparative rating based on the wear rate of the tire when tested under controlled conditions on a specified government test course. For example, a tire graded 150 would wear one and one-half (1½) times as well on the government course as a tire graded 100.
- **Traction:** The traction grades, from highest to lowest are AA, A, B, and C. The grades represent the tire's ability to stop on wet pavement as measured under controlled conditions on specified government test surfaces of asphalt and concrete. A tire marked C may have poor traction performance.
- **Temperature:** The temperature grades are A (the highest), B and C, representing the tire's resistance to the generation of heat and its ability to dissipate heat when tested under controlled conditions on a specified indoor laboratory test wheel.

13. **Maximum Permissible Inflation Pressure:** Indicates the tire manufacturers' maximum permissible pressure and/or the pressure at which the maximum load can be carried by the tire. This pressure is normally higher than the manufacturer's recommended cold inflation pressure which can be found on the Safety Compliance Certification Label or Tire Label which is located on the B-Pillar or the edge of the driver's door. The cold inflation pressure should never be set lower than the recommended pressure on the vehicle label.

The tire suppliers may have additional markings, notes or warnings such as standard load, radial tubeless, etc.

Tires, Wheels and Loading

Additional information contained on the tire sidewall for “LT” type tires

“LT” type tires have some additional information beyond those of “P” type tires; these differences are described below.

Note: Tire Quality Grades do not apply to this type of tire.

1. **LT:** Indicates a tire, designated by the Tire and Rim Association (T&RA), that is intended for service on light trucks.

2. Load Range/Load Inflation

Limits: Indicates the tire’s load-carrying capabilities and its inflation limits.

3. **Maximum Load Dual lb (kg) at psi (kPa) cold:** Indicates the maximum load and tire pressure when the tire is used as a dual; defined as four tires on the rear axle (a total of six or more tires on the vehicle).

4. **Maximum Load Single lb (kg) at psi (kPa) cold:** Indicates the maximum load and tire pressure when the tire is used as a single; defined as two tires (total) on the rear axle.

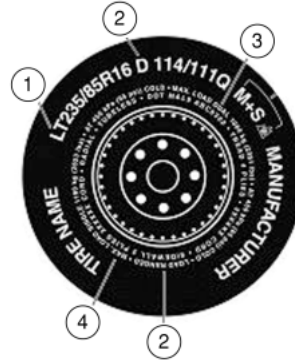

Tires, Wheels and Loading

Information on “T” type tires

“T” type tires have some additional information beyond those of “P” type tires; these differences are described below:

T145/80D16 is an example of a tire size.

Note: The temporary tire size for your vehicle may be different from this example. Tire Quality Grades do not apply to this type of tire.

1. **T:** Indicates a type of tire, designated by the Tire and Rim Association (T&RA), that is intended for temporary service on cars, SUVs, minivans and light trucks.

2. **145:** Indicates the nominal width of the tire in millimeters from sidewall edge to sidewall edge. In general, the larger the number, the wider the tire.

3. **80:** Indicates the aspect ratio which gives the tire’s ratio of height to width. Numbers of 70 or lower indicate a short sidewall.

4. **D:** Indicates a “diagonal” type tire.

R: Indicates a “radial” type tire.

5. **16:** Indicates the wheel or rim diameter in inches. If you change your wheel size, you will have to purchase new tires to match the new wheel diameter.

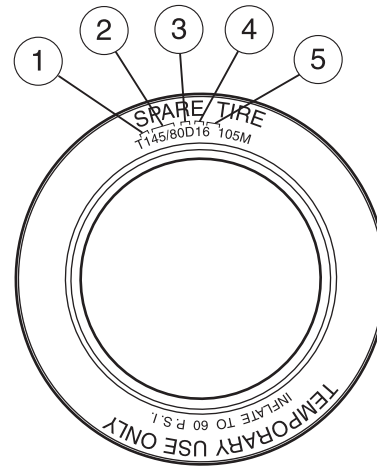

Location of the tire label

You will find a Tire Label containing tire inflation pressure by tire size and other important information located on the B-Pillar or the edge of the driver’s door. Refer to the payload description and graphic in the *Vehicle loading — with and without a trailer* section.

Tires, Wheels and Loading

TIRE PRESSURE MONITORING SYSTEM (TPMS)

Each tire, including the spare (if provided), should be checked monthly when cold and inflated to the inflation pressure recommended by the vehicle manufacturer on the vehicle placard or tire inflation pressure label. (If your vehicle has tires of a different size than the size indicated on the vehicle placard or tire inflation pressure label, you should determine the proper tire inflation pressure for those tires.)

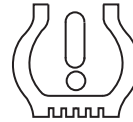

As an added safety feature, your vehicle has been equipped with a tire pressure monitoring system (TPMS) that illuminates a low tire pressure telltale when one or more of your tires is significantly under-inflated. Accordingly, when the low tire pressure telltale illuminates, you should stop and check your tires as soon as possible, and inflate them to the proper pressure. Driving on a significantly under-inflated tire causes the tire to overheat and can lead to tire failure. Under-inflation also reduces fuel efficiency and tire tread life, and may affect the vehicle's handling and stopping ability.

Please note that the TPMS is not a substitute for proper tire maintenance, and it is the driver's responsibility to maintain correct tire pressure, even if under-inflation has not reached the level to trigger illumination of the TPMS low tire pressure telltale.

Your vehicle has also been equipped with a TPMS malfunction indicator to indicate when the system is not operating properly. The TPMS malfunction indicator is combined with the low tire pressure telltale. When the system detects a malfunction, the telltale will flash for approximately one minute and then remain continuously illuminated. This sequence will continue upon subsequent vehicle start-ups as long as the malfunction exists.

When the malfunction indicator is illuminated, the system may not be able to detect or signal low tire pressure as intended. TPMS malfunctions may occur for a variety of reasons, including the installation of replacement or alternate tires or wheels on the vehicle that prevent the TPMS from functioning properly. Always check the TPMS malfunction telltale after replacing one or more tires or wheels on your vehicle to ensure that the replacement or alternate tires and wheels allow the TPMS to continue to function properly.

Tires, Wheels and Loading

The tire pressure monitoring system complies with part 15 of the FCC rules and with RSS-210 of Industry Canada. Operation is subject to the following two conditions: (1) This device may not cause harmful interference, and (2) This device must accept any interference received, including interference that may cause undesired operation.



WARNING: The tire pressure monitoring system is NOT a substitute for manually checking tire pressure. The tire pressure should be checked periodically (at least monthly) using a tire gauge, see *Inflating your tires* in this chapter. Failure to properly maintain your tire pressure could increase the risk of tire failure, loss of control, vehicle rollover and personal injury.

Changing tires with TPMS

Each road tire is equipped with a tire pressure sensor located inside the tire/wheel cavity. The pressure sensor is attached to the valve stem. The pressure sensor is covered by the tire and is not visible unless the tire is removed. Care must be taken when changing the tire to avoid damaging the sensor. It is recommended that you always have your tires serviced by an authorized dealer.

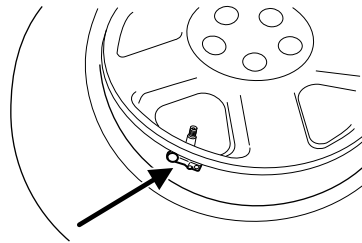

The tire pressure should be checked periodically (at least monthly) using an accurate tire gauge, refer to *Inflating your tires* in this chapter.

Understanding your tire pressure monitoring system (TPMS)

The tire pressure monitoring system measures pressure in your four road tires and sends the tire pressure readings to your vehicle. The low tire pressure warning lamp will turn on if the tire pressure is significantly low. Once the light is illuminated, your tires are under inflated and need to be inflated to the manufacturer's recommended tire pressure. Even if the light turns on and a short time later turns off, your tire pressure still needs to be checked. Visit www.checkmytires.org for additional information.

Tires, Wheels and Loading

When your temporary spare tire is installed

When one of your road tires needs to be replaced with the temporary spare, the TPMS system will continue to identify an issue to remind you that the damaged road wheel/tire needs to be repaired and put back on your vehicle.

To restore the full functionality of the tire pressure monitoring system, have the damaged road wheel/tire repaired and remounted on your vehicle. For additional information, refer to *Changing tires with TPMS* in this section.

When you believe your system is not operating properly

The main function of the tire pressure monitoring system is to warn you when your tires need air. It can also warn you in the event the system is no longer capable of functioning as intended. Please refer to the following chart for information concerning your tire pressure monitoring system:

| Low tire pressure warning light | Possible cause | Customer action required |
|--|------------------------|---|
| Solid warning light | Tire(s) under-inflated | 1. Check your tire pressure to ensure tires are properly inflated; refer to <i>Inflating your tires</i> in this chapter. 2. After inflating your tires to the manufacturer's recommended inflation pressure as shown on the Tire Label (located on the edge of driver's door or the B-Pillar), the vehicle must be driven for at least two minutes over 20 mph (32 km/h) before the light will turn off. |
| | Spare tire in use | Your temporary spare tire is in use. Repair the damaged road wheel/tire and reinstall it on the vehicle to restore system functionality. For a description on how the system functions, refer to <i>When your temporary spare tire is installed</i> in this section. |
| | TPMS malfunction | If your tires are properly inflated and your spare tire is not in use and the light remains on, contact your authorized dealer as soon as possible. |

Tires, Wheels and Loading

| Low tire pressure warning light | Possible cause | Customer action required |
|---------------------------------|-------------------|---|
| Flashing warning light | Spare tire in use | Your temporary spare tire is in use. Repair the damaged road wheel and re-mount it on the vehicle to restore system functionality. For a description of how the system functions under these conditions, refer to <i>When your temporary spare tire is installed</i> in this section. |
| | TPMS malfunction | If your tires are properly inflated and your spare tire is not in use and the TPMS warning light still flashes, contact your authorized dealer as soon as possible. |

When inflating your tires

When putting air into your tires (such as at a gas station or in your garage), the tire pressure monitoring system may not respond immediately to the air added to your tires.

It may take up to two minutes of driving over 20 mph (32 km/h) for the light to turn off after you have filled your tires to the recommended inflation pressure.

How temperature affects your tire pressure

The tire pressure monitoring system (TPMS) monitors tire pressure in each pneumatic tire. While driving in a normal manner, a typical passenger tire inflation pressure may increase approximately 2 to 4 psi (14 to 28 kPa) from a cold start situation. If the vehicle is stationary over night with the outside temperature significantly lower than the daytime temperature, the tire pressure may decrease approximately 3 psi (21 kPa) for a drop of 30°F (17°C) in ambient temperature. This lower pressure value may be detected by the TPMS as being significantly lower than the recommended inflation pressure and activate the TPMS warning for low tire pressure. If the low tire pressure warning light is on, visually check each tire to verify that no tire is flat. (If one or more tires are flat, repair as necessary.) Check air pressure in the road tires. If any tire is under-inflated, carefully drive the vehicle to the nearest location where air can be added to the tires. Inflate all the tires to the recommended inflation pressure.

196

Tires, Wheels and Loading

SNOW TIRES AND CHAINS



WARNING: Snow tires must be the same size, load index, speed rating as those originally provided by Ford. Use of any tire or wheel not recommended by Ford can affect the safety and performance of your vehicle, which could result in an increased risk of loss of vehicle control, vehicle rollover, personal injury and death. Additionally, the use of non-recommended tires and wheels could cause steering, suspension, axle or transfer case/power transfer unit failure.

The tires on your vehicle have all-weather treads to provide traction in rain and snow. However, in some climates, you may need to use snow tires and chains. If you need to use chains, it is recommended that only cable chains are used with steel wheels (of the same size and specifications) as chains may chip aluminum wheels.

Note: The suspension insulation and bumpers will help prevent vehicle damage. Do not remove these components from your vehicle when using snow tires and chains.

Follow these guidelines when using snow tires and chains:

- If possible, avoid fully loading your vehicle.
- Install cable chains only on the front wheels.
- Use only cable chains on 18 inch wheels with P245/60R18 tires.
- Do not use tire chains, cables or optional traction devices on 20 inch or 22 inch wheels and tires.
- Drive cautiously. If you hear the cable chains rub or bang against your vehicle, stop and retighten the cable chains. If this does not work, remove the cable chains to prevent damage to your vehicle.
- Remove the tire cable chains when they are no longer needed. Do not use tire cable chains on dry roads.

Tires, Wheels and Loading

VEHICLE LOADING – WITH AND WITHOUT A TRAILER

This section will guide you in the proper loading of your vehicle and/or trailer, to keep your loaded vehicle weight within its design rating capability, with or without a trailer. Properly loading your vehicle will provide maximum return of vehicle design performance. Before loading your vehicle, familiarize yourself with the following terms for determining your vehicle's weight ratings, with or without a trailer, from the vehicle's Tire Label or Safety Compliance Certification Label:

Base Curb Weight – is the weight of the vehicle including a full tank of fuel and all standard equipment. It does not include passengers, cargo, or optional equipment.

Vehicle Curb Weight – is the weight of your new vehicle when you picked it up from your authorized dealer plus any aftermarket equipment.

Tires, Wheels and Loading

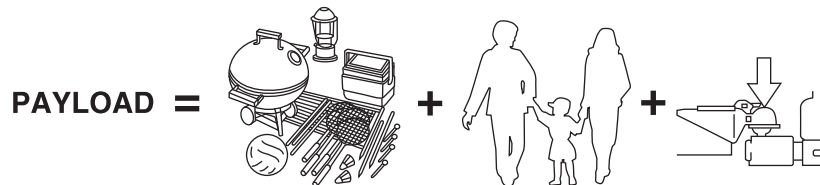

Payload – is the combined weight of cargo and passengers that the vehicle is carrying. The maximum payload for your vehicle can be found on the Tire Label on the B-Pillar or the edge of the driver's door (vehicles exported outside the US and Canada may not have a Tire Label). Look for **“THE COMBINED WEIGHT OF OCCUPANTS AND CARGO SHOULD NEVER EXCEED XXX kg OR XXX lb.”** for maximum payload. The payload listed on the Tire Label is the maximum payload for the vehicle as built by the assembly plant. If any aftermarket or authorized-dealer installed equipment has been installed on the vehicle, the weight of the equipment must be subtracted from the payload listed on the Tire Label in order to determine the new payload.

! **WARNING:** The appropriate loading capacity of your vehicle can be limited either by volume capacity (how much space is available) or by payload capacity (how much weight the vehicle should carry). Once you have reached the maximum payload of your vehicle, do not add more cargo, even if there is space available. Overloading or improperly loading your vehicle can contribute to loss of vehicle control and vehicle rollover.

Tires, Wheels and Loading

Example only:

| TIRE AND LOADING INFORMATION | | | |
|--|--------------------------|------------------------------------|---|
| SEATING CAPACITY | | TOTAL 5 | FRONT 2 REAR 3 |
| The combined weight of occupants and cargo should never exceed : XXX kg or XXX lbs. | | | |
| TIRE | SIZE | COLD TIRE PRESSURE | SEE OWNERS MANUAL FOR ADDITIONAL INFORMATION |
| FRONT | LT225/75R 16.5E | 200 KPA, 29 PSI | |
| REAR | LT225/75R 16.5E | 200 KPA, 29 PSI | |
| SPARE | T145/80D16 P225/60R17 | 420 KPA, 60 PSI 200 KPA, 29 PSI | |

| TIRE AND LOADING INFORMATION | | | |
|---|-----------------|---|--|
| RENSEIGNEMENTS SUR LES PNEUS ET LE CHARGEMENT | | | |
| SEATING CAPACITY | | TOTAL 5 | FRONT 2 REAR 3 |
| NOMBRE DE PLACES | | AVANT 2 | ARRIÈRE 3 |
| The combined weight of occupants and cargo should never exceed 492 kg or 1085 lbs. Le poids total des occupants et du chargement ne doit jamais dépasser 492 kg ou 1085 lbs. | | | |
| TIRE PNEU | SIZE DIMENSIONS | COLD TIRE PRESSURE PRESSION DES PNEUS A FROID | SEE OWNER'S MANUAL FOR ADDITIONAL INFORMATION |
| FRONT AVANT | P235/70R16 | 240 KPA, 35 PSI | VOIR LE MANUEL DE L'USAGER POUR PLUS DE RENSEIGNEMENTS |
| REAR ARRIÈRE | P235/70R16 | 240 KPA, 35 PSI | |
| SPARE DE SECOURS | T145/90R17 | 415 KPA, 60 PSI | |

CARGO =

=



+

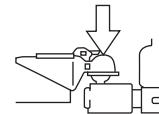

Cargo Weight – includes all weight added to the Base Curb Weight, including cargo and optional equipment. When towing, trailer tongue load weight is also part of cargo weight.

GAW (Gross Axle Weight) – is the total weight placed on each axle (front and rear) – including vehicle curb weight and all payload.

200

Tires, Wheels and Loading

GAWR (Gross Axle Weight Rating) – is the maximum allowable weight that can be carried by a single axle (front or rear). **These numbers are shown on the Safety Compliance Certification Label located on the B-Pillar or the edge of the driver's door. The total load on each axle must never exceed its GAWR.**

Note: For trailer towing information refer to *Trailer towing* found in this chapter or the *RV and Trailer Towing Guide* provided by your authorized dealer.

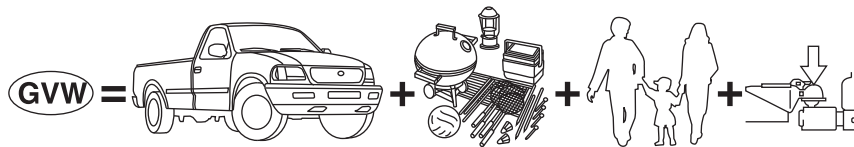

GVW (Gross Vehicle Weight) – is the Vehicle Curb Weight + cargo + passengers.

GVWR (Gross Vehicle Weight Rating) – is the maximum allowable weight of the fully loaded vehicle (including all options, equipment, passengers and cargo). **The GVWR is shown on the Safety Compliance Certification Label located on the B-Pillar or the edge of the driver's door. The GVW must never exceed the GVWR.**

Tires, Wheels and Loading

- Example only:

MFD. BY FORD MOTOR CO.

DATE: XX/XX GVWR: XXXXXLB/ XXXXXKG
 FRONT GAWR: XXXXL REAR GAWR: XXXXLB
 XXXXKG WITH XXXXKG WITH
 XXXX/XXXXXX TIRES: XXXX/XXXXXX TIRES
 XXXX,XX RIMS: XXXX,XX RIMS
 AT XXX kPa/XX PSI COLD AT XXX kPa/XX PSI COLD

THIS VEHICLE CONFORMS TO ALL APPLICABLE FEDERAL MOTOR VEHICLE SAFETY AND THEFT PREVENTION STANDARDS IN EFFECT ON THE DATE OF MANUFACTURE SHOWN ABOVE.

VIN: XXXXXXXXXXXXXXXX XXXXX
 TYPE: XXX XXXXX



EXT PNT: XX RC: XX DSO:
 WB¹ BRK² INT TR³ TP/PS⁴ R⁵ AXLE⁶ TR⁷ SPR⁸ XXXXX
 XXX X XX X XX X XX XXX
 XXXXXXXXXXXX XXX XXXX-XXXXXX-XX

MFD. BY FORD MOTOR CO.

DATE: xx/xx GVWR/PNBV: xxxxx LB/xxxxxKG
 FRONT GAWR/PNBE AV¹ REAR GAWR/PNBE AR²
 xxxxx/xxxxxB xxxxxKG/xxxxLB
 WITH/AVEC TIRES/PNEUS
 xxxxx/xxxxx
 xxxxx/xxxxx
 xxxxxx RIMS/JANTES xxx,xxx

AT/A kPa/PSI/LPC xxx/xx COLD/A FROID xxx/xx
 /JUMEELES

VIN: xxxxxxxxxxxxxxxx xxxxxx
 TYPE: xxx/xxxx COMPLIES: xxx/xxx - xxx xxxxxx
 xxxxxx



EXT PNT: UJ RC: xx DSO:
 WB¹ INT TR³ TP/PS⁴ R⁵ AXLE⁶ TR⁷ SPR⁸ xxxxxx
 xxx xx x xx x xxxxx xxx
 XXXXXXXXXXXX XXX XXXX-XXXXXX-XX

 **WARNING:** Exceeding the Safety Compliance Certification Label vehicle weight rating limits could result in substandard vehicle handling or performance, engine, transmission and/or structural damage, serious damage to the vehicle, loss of control and personal injury.

Tires, Wheels and Loading



GCW (Gross Combined Weight) – is the weight of the loaded vehicle (GVW) plus the weight of the fully loaded trailer.

GCWR (Gross Combined Weight Rating) – is the maximum allowable weight of the vehicle and the loaded trailer – including all cargo and passengers – that the vehicle can handle without risking damage. (Important: The towing vehicles' braking system is rated for operation at GVWR, not at GCWR. Separate functional brakes should be used for safe control of towed vehicles and for trailers where the GCW of the towing vehicle plus the trailer exceed the GVWR of the towing vehicle. **The GCW must never exceed the GCWR.**

Maximum Loaded Trailer Weight – is the highest possible weight of a fully loaded trailer the vehicle can tow. It assumes a vehicle with only mandatory options, no cargo (internal or external), a tongue load of 10–15% (conventional trailer), and driver only (150 lb. [68 kg]). **Consult your authorized dealer (or the *RV and Trailer Towing Guide* provided by your authorized dealer) for more detailed information.**



WARNING: Do not exceed the GVWR or the GAWR specified on the Safety Compliance Certification Label.



WARNING: Do not use replacement tires with lower load carrying capacities than the original tires because they may lower the vehicle's GVWR and GAWR limitations. Replacement tires with a higher limit than the original tires do not increase the GVWR and GAWR limitations.



WARNING: Exceeding any vehicle weight rating limitation could result in serious damage to the vehicle and/or personal injury.

Tires, Wheels and Loading

Steps for determining the correct load limit:

1. Locate the statement "The combined weight of occupants and cargo should never exceed XXX kg or XXX lbs." on your vehicle's placard.
2. Determine the combined weight of the driver and passengers that will be riding in your vehicle.
3. Subtract the combined weight of the driver and passengers from XXX kg or XXX lbs.
4. The resulting figure equals the available amount of cargo and luggage load capacity. For example, if the "XXX" amount equals 1,400 lbs. and there will be five 150 lb. passengers in your vehicle, the amount of available cargo and luggage load capacity is 650 lbs. ($1400 - 750$ (5×150) = 650 lb.). In metric units ($635 - 340$ (5×68) = 295 kg.)
5. Determine the combined weight of luggage and cargo being loaded on the vehicle. That weight may not safely exceed the available cargo and luggage load capacity calculated in Step 4.
6. If your vehicle will be towing a trailer, load from your trailer will be transferred to your vehicle. Consult this manual to determine how this reduces the available cargo and luggage load capacity of your vehicle.

The following gives you a few examples on how to calculate the available amount of cargo and luggage load capacity:

- Another example for your vehicle with 1,400 lb. (635 kg) of cargo and luggage capacity. You decide to go golfing. Is there enough load capacity to carry you, 4 of your friends and all the golf bags? You and four friends average 220 lb. (99 kg) each and the golf bags weigh approximately 30 lb. (13.5 kg) each. The calculation would be: $1,400 - (5 \times 220) - (5 \times 30) = 1,400 - 1,100 - 150 = 150$ lb. Yes, you have enough load capacity in your vehicle to transport four friends and your golf bags. In metric units, the calculation would be: $635 \text{ kg} - (5 \times 99 \text{ kg}) - (5 \times 13.5 \text{ kg}) = 635 - 495 - 67.5 = 72.5$ kg.
- A final example for your vehicle with 1,400 lb. (635 kg) of cargo and luggage capacity. You and one of your friends decide to pick up cement from the local home improvement store to finish that patio you have been planning for the past 2 years. Measuring the inside of the vehicle with the rear seat folded down, you have room for 12-100 lb. (45 kg) bags of cement. Do you have enough load capacity to transport the cement to your home? If you and your friend each weigh 220 lb. (99 kg), the calculation would be: $1,400 - (2 \times 220) - (12 \times 100) = 1,400 - 440 - 1,200 = -240$ lb. No, you do not have enough cargo capacity to carry that much weight. In metric units, the

204

Tires, Wheels and Loading

calculation would be: $635 \text{ kg} - (2 \times 99 \text{ kg}) - (12 \times 45 \text{ kg}) = 635 - 198 - 540 = -103 \text{ kg}$. You will need to reduce the load weight by at least 240 lb. (104 kg). If you remove 3-100 lb. (45 kg) cement bags, then the load calculation would be:

$1,400 - (2 \times 220) - (9 \times 100) = 1,400 - 440 - 900 = 60 \text{ lb}$. Now you have the load capacity to transport the cement and your friend home. In metric units, the calculation would be: $635 \text{ kg} - (2 \times 99 \text{ kg}) - (9 \times 45 \text{ kg}) = 635 - 198 - 405 = 32 \text{ kg}$.

The above calculations also assume that the loads are positioned in your vehicle in a manner that does not overload the Front or the Rear Gross Axle Weight Rating specified for your vehicle on the Safety Compliance Certification Label found on the edge of the driver's door.

TRAILER TOWING

Trailer towing with your vehicle may require the use of a trailer tow option package.

Trailer towing puts additional loads on your vehicle's engine, transmission, axle, brakes, tires and suspension. For your safety and to maximize vehicle performance, be sure to use the proper equipment while towing.

Follow these guidelines to ensure safe towing:

- Do not tow a trailer until your vehicle has been driven at least 1,000 miles (1,600 km).
- Consult your local motor vehicle laws for towing a trailer.
- Refer to the instructions included with towing accessories for the proper installation and adjustment specifications.
- Thoroughly prepare your vehicle for towing. Refer to *Preparing to tow* in this chapter.
- Stay within your vehicle's load limits.
- Use extra caution when driving while trailer towing. Refer to *Driving while you tow* in this chapter.
- Service your vehicle more frequently if you tow a trailer. Refer to *Special operating conditions* in the *Scheduled Maintenance Guide* chapter.

When towing maximum loads under high outside temperatures and on steep grades, the A/C system may cycle on and off to protect the engine from overheating. This may result in a temporary increase of interior temperatures.

Tires, Wheels and Loading

For load specification terms found on the label, refer to *Vehicle loading - with and without a trailer* in this chapter. Remember to figure in the tongue load of your loaded vehicle when figuring the total weight.

| Powertrain | Maximum GCWR - lb (kg) | Maximum Trailer Weight - lb (kg) |
|-------------------|------------------------|----------------------------------|
| 3.7L FWD Class I | 6770 (3072) | 2000 (907) |
| 3.7L AWD Class I | 6940 (3149) | 2000 (907) |
| 3.7L FWD Class II | 8270 (3752) | 3500 (1588) |
| 3.7L AWD Class II | 8440 (3829) | 3500 (1588) |



WARNING: Do not exceed the GVWR or the GAWR specified on the certification label.



WARNING: Towing trailers beyond the maximum recommended gross trailer weight exceeds the limit of the vehicle and could result in engine damage, transmission damage, structural damage, loss of vehicle control, vehicle rollover and personal injury.

Preparing to tow

Use the proper equipment for towing a trailer and make sure it is properly attached to your vehicle. Contact your authorized dealer or a reliable trailer dealer as soon as possible if you require assistance.

Trailer tow connector (vehicles equipped with a Class II trailer tow/prep package)

The trailer tow connector is located under the rear bumper, on the driver's side of the vehicle.

Refer to the following chart for information regarding the factory-equipped trailer tow connector:

| Color | Function |
|---------------|---|
| 1. Dark Green | Right turn signal/brake lamp/hazard flasher |
| 2. Yellow | Left turn signal/brake lamp/hazard flasher |
| 3. Brown | Tail lamps/parking lamps |
| 4. White | Ground |

Tires, Wheels and Loading

Hitches

Do not use hitches that clamp onto the vehicle's bumper or attach to the axle. You must distribute the load in your trailer so that 10–15% of the total weight of the trailer is on the tongue.

Safety chains

Always connect the trailer's safety chains to the hook retainers on the vehicle. To connect the trailer's safety chains, cross the chains under the trailer tongue and allow slack for turning corners.

If you use a rental trailer, follow the instructions that the rental agency gives to you.

Do not attach safety chains to the bumper.

Trailer brakes

Be sure your trailer conforms to all applicable local and Federal regulations regarding trailer braking. If your trailer is equipped with electronically-controlled brakes you will need to have an electronic brake controller with associated wiring installed to your vehicle by an authorized dealer.



WARNING: Do not connect a trailer's hydraulic brake system directly to your vehicle's brake system. Your vehicle may not have enough braking power and your chances of having a collision greatly increase.

The braking system of the tow vehicle is rated for operation at the GVWR not GCWR.

Trailer lamps

Trailer lamps are required on most towed vehicles. Make sure all running lights, brake lights, turn signals and hazard lights are working.

Do not splice into the vehicle lamp wiring for trailer lamps. Your vehicle uses an advanced electronic module to control and monitor your vehicle lamps. Splicing into the wiring or attaching wiring to the vehicle bulb may DISABLE the rear vehicle lamps or cause them not to function properly. Your lamp outage feature may also be disabled or provide incorrect information.

Tires, Wheels and Loading

Driving while you tow

When towing a trailer:

- Do not drive faster than 70 mph (113 km/h) during the first 500 miles (800 km) of trailer towing and don't make full-throttle starts.
- Turn off the speed control. The speed control may shut off automatically when you are towing on long, steep grades.
- Use a lower gear to eliminate excessive shifting and assist in transmission cooling. For additional information, refer to *Automatic transmission operation* in the *Driving* chapter.
- Allow more distance for stopping with a trailer attached; anticipate stops and brake gradually.

Servicing after towing

If you tow a trailer for long distances, your vehicle will require more frequent service intervals. Refer to *Special operating conditions* in the *Scheduled Maintenance Guide* chapter.

Trailer towing tips

- Practice turning, stopping and backing-up before starting on a trip to get the feel of the vehicle-trailer combination. When turning, make wider turns so the trailer wheels will clear curbs and other obstacles.
- To aid in engine/transmission cooling and A/C efficiency during hot weather while stopped in traffic, place the gearshift lever in P (Park).
- After you have traveled 50 miles (80 km), thoroughly check your hitch, electrical connections and trailer wheel lug nuts.
- If you are driving down a long or steep hill, shift to a lower gear. Do not apply the brakes continuously, as they may overheat and become less effective.
- Vehicles with trailers should not be parked on a grade. If you must park on a grade, place wheel chocks under the trailer's wheels.

Tires, Wheels and Loading

RECREATIONAL TOWING

Follow these guidelines for your specific powertrain combination to tow your vehicle for personal travel (such as behind a motor home or a truck).

Note: Put your climate control system in recirculated air mode to prevent exhaust fumes from entering the vehicle. Refer to the *Climate Controls* chapter for more information.

In case of roadside emergency with a disabled vehicle, please refer to *Wrecker towing* in the *Roadside Emergencies* chapter.

These guidelines are designed to prevent damage to your vehicle.

Front-wheel drive (FWD) vehicles:

Tow your FWD vehicle with all four wheels on the ground or with the front wheels off the ground by using a tow dolly. If you are using a tow dolly follow the instructions specified by the equipment provider.

All-wheel drive (AWD) vehicles:

Tow your AWD vehicle with all four wheels on the ground or with all four wheels off the ground using a vehicle transport trailer. **Do not tow your AWD vehicle with the front wheels off the ground (by using a tow dolly) and the rear wheels on the ground; this will cause damage to your AWD system.** If you are using a vehicle transport trailer, follow the instruction specified by the equipment provider.

Note: If you tow your vehicle with all four wheels on the ground, follow these instructions:

- Tow only in the forward direction.
- Release the parking brake.
- Place the transmission shift lever in N (Neutral).
- Place the ignition in the accessory position (refer to *Starting* in the *Driving* chapter).
- Do not exceed 65 mph (105 km/h)
- Start the engine and allow it to run for five minutes at the beginning of each day and at each fuel stop.

Driving

STARTING

Ignition modes

1. Off — This position shuts the engine and all electrical accessories off. Press and release the START/STOP button without applying the brake pedal when your vehicle is in accessory or on modes or when the engine is running. **Note:** When the vehicle is in motion, a single press and release of the START/STOP button will not switch off the engine. In order to switch off the engine while the vehicle is in motion, press and hold the START/STOP button for at least one second.

2. Accessory — This allows electrical accessories such as the radio to operate while the engine is not running. Press and release the START/STOP button without applying the brake pedal. ACCESSORY POWER ACTIVE and PRESS BRAKE TO START will be displayed in the message center. Refer to *Message center* in the *Instrument Cluster* chapter for more information.

3. On — This will power your vehicle's electrical system and the warning lights in the instrument cluster will illuminate, but the engine will remain off. Press and hold the START/STOP button for at least one second without applying the brake pedal.

4. Start — Cranks the engine. Press the START/STOP button (for any length of time) while applying the brake pedal.

Preparing to start your vehicle

Engine starting is controlled by the powertrain control system.

This system meets all Canadian interference-causing equipment standard requirements regulating the impulse electrical field strength of radio noise.

When starting a fuel-injected engine, avoid pressing the accelerator before or during starting. Only use the accelerator when you have difficulty starting the engine. For more information on starting the vehicle, refer to *Starting the engine* in this chapter.





WARNING: Extended idling at high engine speeds can produce very high temperatures in the engine and exhaust system, creating the risk of fire or other damage.



WARNING: Do not park, idle, or drive your vehicle in dry grass or other dry ground cover. The emission system heats up the engine compartment and exhaust system, which can start a fire.

Driving

 **WARNING:** Do not start your vehicle in a closed garage or in other enclosed areas. Exhaust fumes can be toxic. Always open the garage door before you start the engine. See *Guarding against exhaust fumes* in this chapter for more instructions.

 **WARNING:** If you smell exhaust fumes inside your vehicle, have your dealer inspect your vehicle immediately. Do not drive if you smell exhaust fumes.

Important safety precautions

When the engine starts, the idle RPM runs higher than normal in order to warm the engine. If the engine idle speed does not slow down automatically, have the vehicle checked.

Before starting the vehicle:

1. Make sure all vehicle occupants have buckled their safety belts. For more information on safety belts and their proper usage, refer to the *Seating and Safety Restraints* chapter.
2. Make sure vehicle accessories are off.
 - Make sure the parking brake is set.

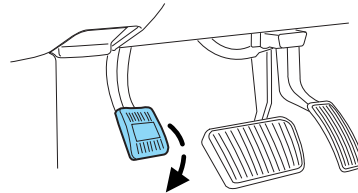

Driving

- Make sure the gearshift lever is in P (Park).

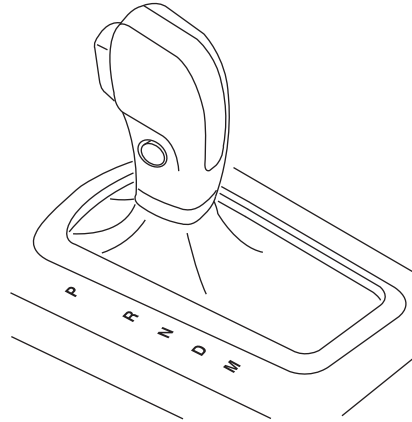

Push button start system

Your vehicle is equipped with the push button start system. You can start your vehicle by pressing the start button in combination with the brake pedal rather than using a key. The start button is located on the instrument panel to the right of the steering wheel.

In order to operate the push button start system and start the vehicle, your Intelligent Access key (IA key) must be present inside the vehicle.

1. Press the START/STOP button (for any length of time) while applying the brake pedal. Your vehicle has a computer assisted cranking system that assists in starting the engine. After releasing the button, the engine may continue cranking for up to 10 seconds or until the vehicle starts.

Note: You can start the engine from any ignition mode. **Note:** The indicator light on the start button will illuminate when the vehicle is in on mode and when the engine is started.

2. After idling for a few seconds, release the parking brake, apply the brake, shift into gear and drive.

There may be areas inside your vehicle where the IA key is not detected. If the message NO KEY DETECTED appears on your message center

212

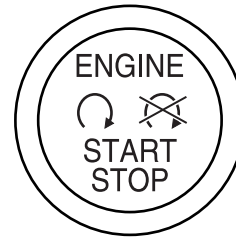

when you press the START/STOP button, it may be necessary to move your IA key to another area within the vehicle. The IA key may not be detected near the roof (between the driver or passenger sunvisor and the roof, or in the overhead console area) or in the extreme corners of the rear package tray, near your audio speakers. It is not recommended that you stow the IA key in these locations. If you move the IA key to a location where it has been detected before and you still see the NO KEY DETECTED message, your IA key's battery may be low or you may be in an area with excessive radio frequency interference. If this occurs, you can use the back-up method to start your vehicle (see below).

Backup method of starting: Your IA key uses a radio frequency signal to communicate with your vehicle and authorize your vehicle to start when you press the START/STOP button and apply the brake pedal. If excessive radio frequency interference is present in the area, or if the battery in your IA key is low, it may be necessary to start your car by inserting the IA key in the backup slot, located in the center console. Insert the IA key into the slot with buttons facing out and with key ring up. After inserting the IA key into the backup slot, use the START/STOP button and brake pedal to start your vehicle as usual. The vehicle should respond normally as long as the IA key is in the backup slot in the center console. Once the vehicle is started, the IA key can be removed from the backup slot, if desired.

Fast restart feature: The fast restart feature allows you to re-start your vehicle within 20 seconds of switching the vehicle off, if a valid IA key is not present when the vehicle is switched off. When you switch your vehicle off without an IA key in the passenger compartment or trunk, the message RESTART NOW OR KEY IS NEEDED will be displayed in the message center. You can re-start the vehicle (by applying the brake pedal and pressing the START/STOP button) for up to 20 seconds, even though the IA key is not present. After 20 seconds have expired, you can no longer start your vehicle without the IA key present inside the vehicle.

Switching the vehicle off when not in P (Park): It is recommended that you shift into the P (Park) position before switching your vehicle off. If you switch your vehicle off with the shifter in any position other than P (Park), the message SHIFT TO PARK will be displayed in the message center. If the vehicle is left in this state, your key in ignition chime will activate when the driver door is opened, and you may drain your vehicle's battery. In order to avoid draining your battery, it is recommended that you always shift to P (Park) before or immediately after switching your vehicle off.

Driving

Absence of the Intelligent Access key: Once the vehicle has started, the vehicle will remain running until being turned off by the START/STOP button, even if the IA key is no longer found in the vehicle. Whenever a door is opened and then closed while the vehicle is running, the system will search for an IA key inside the vehicle and the message center will display NO KEY DETECTED if the IA key is no longer present. This message is a reminder that someone else in the vehicle may have taken the IA key when exiting the vehicle. If the IA key is no longer present in the vehicle, you will not be able to re-start your vehicle outside of the Fast Restart time (see *Fast Restart Feature* above). It is important to be aware of where your IA key is located in the vehicle, to avoid becoming stranded without an IA key.

Your vehicle may have remote start capability. Refer to *Remote entry system* in the *Locks and Security* chapter.

Guarding against exhaust fumes

Carbon monoxide is present in exhaust fumes. Take precautions to avoid its dangerous effects.



WARNING: If you smell exhaust fumes inside your vehicle, have your dealer inspect your vehicle immediately. Do not drive if you smell exhaust fumes.

Important ventilating information

If the engine is idling while the vehicle is stopped for a long period of time, open the windows at least 1 inch (2.5 cm) or adjust the heating or air conditioning to bring in fresh air.

ENGINE BLOCK HEATER (IF EQUIPPED)

An engine block heater warms the engine coolant which aids in starting and allows the heater/defroster system to respond quickly. If your vehicle is equipped with this system, your equipment includes a heater element which is installed in your engine block and a wire harness which allows the user to connect the system to a grounded 120 volt A/C electrical source. The block heater system is most effective when outdoor temperatures reach below 0°F (-18°C).



WARNING: Failure to follow engine block heater instructions could result in property damage or physical injury.

Driving



WARNING: To reduce the risk of electrical shock, do not use your heater with ungrounded electrical systems or two-pronged (cheater) adapters.

Prior to using the engine block heater, follow these recommendations for proper and safe operation:

- For your safety, use an outdoor extension cord that is product certified by Underwriter's Laboratory (UL) or Canadian Standards Association (CSA). Use only an extension cord that can be used outdoors, in cold temperatures, and is clearly marked "Suitable for Use with Outdoor Appliances." Never use an indoor extension cord outdoors; it could result in an electric shock or fire hazard.
- Use a 16-gauge outdoor extension cord, minimum.
- Use as short an extension cord as possible.
- Do not use multiple extension cords. Instead, use one extension cord which is long enough to reach from the engine block heater cord to the outlet without stretching.
- Make certain that the extension cord is in excellent condition (not patched or spliced). Store your extension cord indoors at temperatures above 32°F (0°C). Outdoor conditions can deteriorate extension cords over a period of time.
- To reduce the risk of electrical shock, do not use your heater with ungrounded electrical systems or two pronged (cheater) adapters. Also ensure that the block heater, especially the cord, is in good condition before use.
- Make sure that when in operation, the extension cord plug/engine block heater cord plug connection is free and clear of water in order to prevent possible shock or fire.
- Be sure that areas where the vehicle is parked are clean and clear of all combustibles such as petroleum products, dust, rags, paper and similar items.
- Be sure that the engine block heater, heater cord and extension cord are solidly connected. A poor connection can cause the cord to become very hot and may result in an electrical shock or fire. Be sure to check for heat anywhere in the electrical hookup once the system has been operating for approximately a half hour.
- Finally, have the engine block heater system checked during your fall tune-up to be sure it's in good working order.

215

Driving

How to use the engine block heater

Ensure the receptacle terminals are clean and dry prior to use. To clean them, use a dry cloth.

Depending on the type of factory installed equipment, your engine block heater will use .4 to 1.0 kilowatt-hours of energy per hour of use. Your factory installed block heater system does not have a thermostat; however, maximum temperature is attained after approximately three hours of operation. Block heater operation longer than three hours will not improve system performance and will unnecessarily use additional electricity.

Make sure system is unplugged and properly stowed before driving the vehicle. While not in use, make sure the protective cover seals the prongs of the engine block heater cord plug.

BRAKES

Occasional brake noise is normal. If a metal-to-metal, continuous grinding or continuous squeal sound is present, the brake linings may be worn-out and should be inspected by an authorized dealer. If the vehicle has continuous vibration or shudder in the steering wheel while braking, the vehicle should be inspected by an authorized dealer.

Refer to *Warning lights and chimes* in the *Instrument Cluster* chapter for information on the brake system warning light.

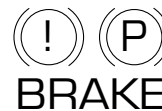

Four-wheel anti-lock brake system (ABS)

Your vehicle is equipped with an anti-lock braking system (ABS). This system helps you maintain steering control during emergency stops by keeping the brakes from locking. Noise from the ABS pump motor and brake pedal pulsation may be observed during ABS braking and the brake pedal may suddenly travel a little farther as soon as ABS braking is done and normal brake operation resumes. These are normal characteristics of the ABS and should be no reason for concern.

Using ABS

When hard braking is required, apply continuous force on the brake pedal. Do not pump the brake pedal since this will reduce the effectiveness of the ABS and will increase your vehicle's stopping distance. The ABS will be activated immediately, allowing you to retain steering control during hard braking and on slippery surfaces. However, the ABS does not decrease stopping distance.

216

Brake assist

The brake assist system provides full braking force during panic braking situations. It detects a rapid application of the brake pedal and uses the ABS system to achieve maximum braking pressure. Once a panic brake application is detected, the system will remain activated as long as the brake pedal is pressed or ABS is engaged. The system is deactivated by either releasing the brake pedal or coming to a complete stop. When the system activates, noise from the ABS pump motor and brake pedal pulsation may be observed; this is normal.

ABS warning lamp

The ABS lamp in the instrument cluster momentarily illuminates when the ignition is turned on. If the light does not illuminate during start up, remains on or flashes, the ABS may be disabled and may need to be serviced.

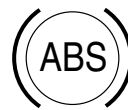

Even when the ABS is disabled, normal braking is still effective. If your BRAKE warning lamp illuminates with the parking brake released, have your brake system serviced immediately by an authorized dealer.



Parking brake

Apply the parking brake whenever the vehicle is parked. To set the parking brake, press the parking brake pedal down until the pedal stops.

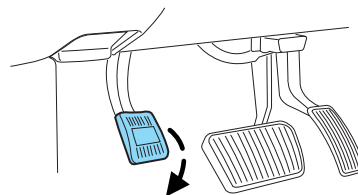

The BRAKE warning lamp in the instrument cluster illuminates and remains illuminated (when the ignition is turned on) until the parking brake is released.



Driving



WARNING: Always set the parking brake fully and make sure that the gearshift is securely latched in P (Park). Turn the ignition to the lock position and remove the key whenever you leave the vehicle. For vehicles with the push button start system, remove the IA key whenever you leave the vehicle.

The parking brake is not recommended to stop a moving vehicle. However, if the normal brakes fail, the parking brake can be used to stop your vehicle in an emergency. Since the parking brake applies only the rear brakes, the vehicle's stopping distance will increase greatly and the handling of your vehicle will be adversely affected.

Press the parking brake pedal downward again to release the parking brake. Driving with the parking brake on will cause the brakes to wear out quickly and reduce fuel economy.

Note: If the vehicle is driven with the parking brake applied, a chime will sound.

ADVANCETRAC® WITH ROLL STABILITY CONTROL™ (RSC®) STABILITY ENHANCEMENT SYSTEM

The AdvanceTrac® with RSC® system provides the following stability enhancement features for certain driving situations:

- Traction control system (TCS), which functions to help avoid drive-wheel spin and loss of traction.
- Electronic stability control (ESC), which functions to help avoid skids or lateral slides
- Roll Stability Control™ (RSC®), which functions to help avoid a vehicle roll-over.



WARNING: Vehicle modifications involving braking system, aftermarket roof racks, suspension, steering system, tire construction and/or wheel/tire size may change the handling characteristics of the vehicle and may adversely affect the performance of the AdvanceTrac® with RSC® system. In addition, installing any stereo loudspeakers may interfere with and adversely affect the AdvanceTrac® with RSC® system. Install any aftermarket stereo loudspeaker as far as possible from the front center console, the tunnel, and the front seats in order to minimize the risk of interfering with the AdvanceTrac® with RSC® sensors. Reducing the effectiveness of the AdvanceTrac® with RSC® system could lead to an increased risk of loss of vehicle control, vehicle rollover, personal injury and death.

Driving

 **WARNING:** Remember that even advanced technology cannot defy the laws of physics. It's always possible to lose control of a vehicle due to inappropriate driver input for the conditions. Aggressive driving on any road condition can cause you to lose control of your vehicle increasing the risk of personal injury or property damage. Activation of the AdvanceTrac® with RSC® system is an indication that at least some of the tires have exceeded their ability to grip the road; this could reduce the operator's ability to control the vehicle, potentially resulting in a loss of vehicle control, vehicle rollover, personal injury and death. If your AdvanceTrac® with RSC® system activates, SLOW DOWN.

 **WARNING:** If a failure has been detected within the AdvanceTrac® with RSC® system, the stability control light and stability control off light will illuminate steadily. Verify that the AdvanceTrac® with RSC® system was not manually disabled through the message center. If the stability control light and stability control off light still illuminate steadily, have the system serviced by an authorized dealer immediately. Operating your vehicle with AdvanceTrac® with RSC® disabled could lead to an increased risk of loss of vehicle control, vehicle rollover, personal injury and death.

The AdvanceTrac® with RSC® system automatically enables each time the engine is started. All features of the AdvanceTrac® with RSC® system (TCS, ESC, and RSC®) are active and monitor the vehicle from start-up. However, the system will only intervene if the driving situation requires it.

The AdvanceTrac® with RSC® system includes a traction control off selection located in the message center, a stability control light and a



stability control off light in the instrument cluster. Refer to *Message center* in the *Instrument cluster* section for more information. Both the stability control light and the stability control off light will illuminate temporarily during start-up as part of a normal system self-check. The stability control light may illuminate (flash) during certain driving conditions which cause the AdvanceTrac® with RSC® system to operate. If the stability control light and stability control off light illuminate steadily, have the system serviced by an authorized dealer immediately. The message center will also indicate a failure with the AdvanceTrac® with RSC® system.

219

Driving

When AdvanceTrac® with RSC® performs a normal system self-check, some drivers may notice a slight movement of the brake, and/or a rumble, grunting, or grinding noise after startup and when driving off.

When an event occurs that activates AdvanceTrac® with RSC® you may experience the following:

- A slight deceleration of the vehicle
- The stability control light will flash.
- A vibration in the pedal when your foot is on the brake pedal
- If the driving condition is severe and your foot is not on the brake, the brake pedal may move as the systems applies higher brake forces. You may also hear a whoosh of air from under the instrument panel during this severe condition.
- The brake pedal may feel stiffer than usual.

Traction control system (TCS)

Traction control is a driver aid feature that helps your vehicle maintain traction of the wheels, typically when driving on slippery and/or hilly road surfaces, by detecting and controlling wheel spin.

Excessive wheel spin is controlled in two ways, which may work separately or in tandem; engine traction control and brake traction control. Engine traction control works to limit drive-wheel spin by momentarily reducing engine power. Brake traction control works to limit wheel spin by momentarily applying the brakes to the wheel that is slipping. Traction control is most active at low speeds.

During traction control events, the stability control light in the instrument cluster will flash.

If the traction control system is activated excessively in a short period of time, the braking portion of the system may become temporarily disabled to allow the brakes to cool down. In this situation, traction control will use only engine power reduction or transfer to help control the wheels from over-spinning. When the brakes have cooled down, the system will regain all features. Anti-lock braking, RSC®, and ESC are not affected by this condition and will continue to function during the cool-down period.

The engine traction control and brake traction control system may be deactivated in certain situations. See the *Switching off AdvanceTrac® with RSC®* section below.

Electronic stability control (ESC)

Electronic stability control (ESC) may enhance your vehicle's directional stability during adverse maneuvers, for example when cornering severely or avoiding objects in the roadway. ESC operates by applying brakes to one or more of the wheels individually and, if necessary, reducing engine power if the system detects that the vehicle is about to skid or slide laterally.

During ESC events the stability control light in the instrument cluster will flash.

Certain adverse driving maneuvers may activate the ESC system, which include but are not limited to:

- Taking a turn too fast
- Maneuvering quickly to avoid an accident, pedestrian or obstacle
- Driving over a patch of ice or other slippery surfaces
- Changing lanes on a snow-rutted road
- Entering a snow-free road from a snow-covered side street, or vice versa
- Entering a paved road from a gravel road, or vice versa
- Cornering while towing a heavily loaded trailer (refer to *Trailer towing* in the *Tires, Wheels and Loading* chapter).

The electronic stability control system may be deactivated in certain situations. See the *Switching off AdvanceTrac® with RSC®* section following.

Roll Stability Control™ (RSC®)

Roll Stability Control™ (RSC®) may help to maintain roll stability of the vehicle during adverse maneuvers. RSC® operates by detecting the vehicle's roll motion and the rate at which it changes and by applying the brakes to one or more wheels individually.

During an event that activates RSC® the stability control light in the instrument cluster will flash.

Certain adverse driving maneuvers may activate the RSC® system, which include:

- Emergency lane-change
- Taking a turn too fast
- Quick maneuvering to avoid an accident, pedestrian or obstacle

The RSC® system may be deactivated in certain situations. See the *Switching off AdvanceTrac® with RSC®* section following.

Driving

Switching off AdvanceTrac® with RSC®

If the vehicle is stuck in snow, mud or sand, and seems to lose engine power, switching off certain features of the AdvanceTrac® with RSC® system may be beneficial because the wheels are allowed to spin. This will restore full engine power and will enhance momentum through the obstacle.

To switch off the AdvanceTrac® with RSC® system, select traction control off in the message center. Full features of the AdvanceTrac® with RSC® system can be restored by selecting traction control on, or by turning off and restarting the engine.

If you switch off the AdvanceTrac® with RSC® system, the stability control off light will illuminate steadily. Selecting traction control on will turn off the stability control light.



In R (Reverse), ABS and the engine traction control and brake traction control features will continue to function. However, ESC and RSC® are disabled.

| AdvanceTrac® Features | | | | | |
|---|----------------------------|---|------------------------|----------|----------|
| Control switch functions | Mode | Stability control light  | Message center display | ESC/RSC® | TCS |
| Default at start-up | System initialization | Turns on during bulb check | Nothing displayed | Enabled | Enabled |
| Control switch pressed once momentarily | Traction control OFF | On | TRACTION CONTROL OFF | Enabled | Disabled |
| Control switch pressed again after deactivation | AdvanceTrac® fully enabled | Off | ADVANCE-TRAC ON | Enabled | Enabled |

TRAILER SWAY CONTROL

When properly equipped, trailer sway control will use the vehicle's AdvanceTrac® with RSC® system to detect and help reduce trailer sway by applying brake force at individual wheels and, if necessary, by reducing engine power. Trailer sway control is only enabled above 40 mph (64 km/h).



WARNING: Trailer sway control does not prevent a trailer from swaying. It mitigates the sway from increasing once it has occurred. If you are experiencing trailer sway, it is likely that the trailer is improperly loaded for the correct tongue weight or the speed of the vehicle and trailer is too high. Pull the vehicle-trailer over to a safe location to check the trailer weight distribution and tongue load, and reduce speed to a safe level while towing. If trailer sway is experienced, SLOW DOWN.

During trailer sway control events, the stability control light in the instrument cluster will flash momentarily. The message center will also display **TRAILER SWAY REDUCE SPEED**. In some cases when trailer sway is detected, the vehicle speed is too high and may be at or above a speed at which trailer sway will grow continuously. This may cause the system to activate multiple times, and you may experience a slight deceleration of the vehicle.

Disabling trailer sway control

Trailer sway control can be disabled during any key cycle. Refer to *Message center* in the *Instrument Cluster* chapter for more information. Note that even if it was disabled before turning off the vehicle, trailer sway control will be re-enabled at each new key cycle.



WARNING: Turning off trailer sway control increases the risk of loss of vehicle control, serious injury, or death. Ford does not recommend disabling this feature except in situations where speed reduction may be detrimental (e.g., hill climbing), the driver has significant trailer towing experience, and can control trailer sway and maintain safe operation.

Driving

STEERING

To help prevent damage to the power steering system:

- Never hold the steering wheel at its furthest turning points (until it stops) for more than a few seconds when the engine is running.
- Do not operate the vehicle with a low power steering fluid level (below the MIN mark on the reservoir).
- Some noise is normal during operation. If the noise is excessive, check for a low power steering fluid level before seeking service by your authorized dealer.
- Heavy or uneven steering efforts may be caused by a low power steering fluid level. Check for a low power steering fluid level before seeking service by your authorized dealer.
- Do not fill the power steering fluid reservoir above the MAX mark on the reservoir.

If the power steering system breaks down (or if the engine is turned off), you can steer the vehicle manually, but it takes more effort.

If the steering wanders or pulls, check for:

- An improperly inflated tire
- Uneven tire wear
- Loose or worn suspension components
- Loose or worn steering components
- Improper steering alignment

A high crown in the road or high crosswinds may also make the steering seem to wander/pull.

BRAKE-SHIFT INTERLOCK

This vehicle is equipped with a brake-shift interlock (BSI) feature that prevents the gearshift lever from being moved from P (Park) when the ignition is in the on position unless the brake pedal is pressed.

If you cannot move the gearshift lever out of P (Park) with ignition in the on position and the brake pedal pressed, it is possible that a fuse has blown or the vehicle's brake lamps are not operating properly. Refer to *Fuses and relays* in the *Roadside Emergencies* chapter.

Driving

If the fuse is not blown and the brake lamps are working properly, the following procedure will allow you to move the gearshift lever from P (Park):

1. Apply the parking brake, turn the ignition key to the off position, and remove the key.
2. Using a screwdriver (or similar tool), carefully pry off and remove the BSI access panel.

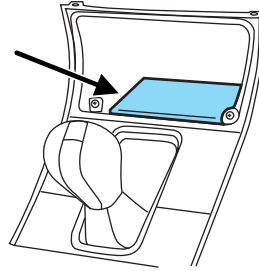

3. Locate the brake shift interlock lever in front of the shifter assembly.
4. Apply the brake pedal. Gently pull and hold the brake shift interlock lever while pulling the gearshift lever out of the P (Park) position and into the N (Neutral) position.

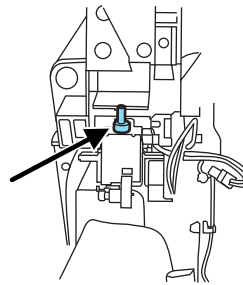

5. Install the trim panel.
6. Apply the brake pedal, start the vehicle, and release the parking brake.

See your authorized dealer as soon as possible if this procedure is used.



WARNING: Do not drive your vehicle until you verify that the brakelamps are working.



WARNING: Always set the parking brake fully and make sure the gearshift is latched in P (Park). Turn the ignition to the off position and remove the key whenever you leave your vehicle.

Driving



WARNING: If the parking brake is fully released, but the brake warning lamp remains illuminated, the brakes may not be working properly. See your authorized dealer.

AUTOMATIC TRANSMISSION OPERATION

Automatic transmission adaptive learning

Your transmission is equipped with an adaptive learning strategy found in the vehicle computer. This feature is designed to increase durability and provide consistent shift feel over the life of the vehicle. A new vehicle or transmission may have firm and/or soft shifts. This operation is considered normal and will not affect function or durability of the transmission. Over time, the adaptive learning process will fully update transmission operation. Additionally, whenever the battery is disconnected or a new battery installed, the strategy must be relearned.

Understanding the gearshift positions of the 6-speed automatic transmission

P (Park)

This position locks the transmission and prevents the front wheels from turning.

To put your vehicle in gear:

- Press the brake pedal
- Move the gearshift lever into the desired gear

To put your vehicle in P (Park):

- Come to a complete stop
- Move the gearshift lever and securely latch it in P (Park)

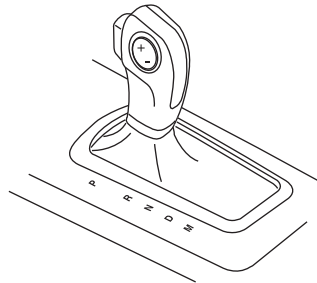

WARNING: Always set the parking brake fully and make sure the gearshift is latched in P (Park). Turn the ignition to the off position and remove the key whenever you leave your vehicle.

R (Reverse)

With the gearshift lever in R (Reverse), the vehicle will move backward. Always come to a complete stop before shifting into and out of R (Reverse).

226

N (Neutral)

With the gearshift lever in N (Neutral), the vehicle can be started and is free to roll. Hold the brake pedal down while in this position.

D (Drive) with Overdrive

The normal driving position for the best fuel economy. Transmission operates in gears one through six.

M (Manual)

- Provides maximum engine braking.
- Will downshift to the lowest available gear for the current vehicle speed; allows for first gear when vehicle reaches slower speeds.

Understanding your SelectShift Automatic™ Transmission (SST)

This vehicle is equipped with a SelectShift Automatic™ transmission (SST) gearshift lever. SST is an automatic transmission with the ability for the driver to change gears up or down as desired. By moving the gearshift lever from D (Drive) to M (Manual), you now have control of selecting the gear you desire using the toggle switch on the gearshift lever.

Gearshift lever toggle switch

- To manually downshift the transmission with the gearshift lever in M (Manual), press - on the gearshift lever.
- To manually upshift the transmission with the gearshift lever in M (Manual), press + on the gearshift lever.

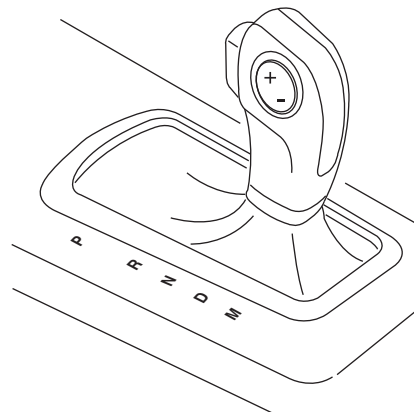

Driving

Recommended shift speeds

Upshift according to the following chart:

| Upshifts when accelerating (recommended for best fuel economy) | |
|---|------------------|
| Shift from: | |
| 1 - 2 | 15 mph (24 km/h) |
| 2 - 3 | 25 mph (40 km/h) |
| 3 - 4 | 40 mph (64 km/h) |
| 4 - 5 | 45 mph (72 km/h) |
| 5 - 6 | 50 mph (80 km/h) |

The message center display in the instrument cluster will show the current selected gear you are in.

In order to prevent the engine from running at too low an RPM, which may cause it to stall, the SST will automatically make some downshifts even if it has determined that you have not downshifted in time. It will still allow you to downshift at any time as long as the SST determines that the engine will not be damaged from over-revving.

Engine damage may occur if excessive engine revving is held without shifting.

Hill start assist (HSA) system

The hill start assist system makes it easier to pull away when the vehicle is on a slope without the need to use the parking brake. When hill start assist is active, the vehicle will remain stationary on the slope for up to three seconds after you release the brake pedal. During this time, you have time to move your foot from the brake to the accelerator pedal and pull away. The brakes are released automatically once the engine has developed sufficient drive to prevent the vehicle from rolling down the slope. This is an advantage when pulling away on a slope; for example from a car park ramp, traffic lights or when reversing uphill into a parking space.



WARNING: The hill start assist system does not replace the parking brake. When you leave the vehicle, always apply the parking brake and select first or reverse gear.

Using hill start assist

Hill start assist is activated automatically when the vehicle is stopped on a slope greater than five degrees. Hill start assist operates with the vehicle facing downhill if reverse gear is selected.



WARNING: You must remain in the vehicle once you have activated hill start assist.

Activating hill start assist

1. Press the brake pedal to bring the vehicle to a complete standstill. Keep the brake pedal pressed.
2. If the sensors detect that the vehicle is on a slope, hill start assist will be activated automatically.
3. When you remove your foot from the brake pedal, the vehicle will remain on the slope without rolling away for approximately up to three seconds. This hold time will automatically be extended if you are in the process of driving off.
4. Drive off in the normal manner. The brakes will be released automatically.



WARNING: If the engine is revved excessively, or if a malfunction is detected when hill start assist is active, hill start assist will be deactivated.

If your vehicle gets stuck in mud or snow

If your vehicle gets stuck in mud or snow, it may be rocked out by shifting between forward and reverse gears, stopping between shifts in a steady pattern. Press lightly on the accelerator in each gear.

Do not rock the vehicle if the engine is not at normal operating temperature or damage to the transmission may occur.

Do not rock the vehicle for more than a minute or damage to the transmission and tires may occur, or the engine may overheat.

It may be beneficial to turn the AdvanceTrac® with RSC system off so the wheels are allowed to spin.

Driving

REVERSE SENSING SYSTEM

The reverse sensing system (RSS) sounds a tone to warn the driver of obstacles near the rear bumper when the R (Reverse) is selected and the vehicle is moving at speeds less than 3 mph (5 km/h). The system is not effective at speeds above 3 mph (5 km/h) and may not detect certain angular or moving objects.



WARNING: To help avoid personal injury, please read and understand the limitations of the reverse sensing system as contained in this section. Reverse sensing is only an aid for some (generally large and fixed) objects when moving in reverse on a flat surface at “parking speeds”. Inclement weather may also affect the function of the RSS; this may include reduced performance or a false activation.



WARNING: To help avoid personal injury, always use caution when in R (Reverse) and when using the RSS.



WARNING: This system is not designed to prevent contact with small or moving objects. The system is designed to provide a warning to assist the driver in detecting large stationary objects to avoid damaging the vehicle. The system may not detect smaller objects, particularly those close to the ground.



WARNING: Certain add-on devices such as large trailer hitches, bike or surfboard racks and any device that may block the normal detection zone of the RSS system may create false beeps.

Driving

The RSS detects obstacles up to six feet (two meters) from the rear bumper with a decreased coverage area at the outer corners of the bumper, (refer to the figures for approximate zone coverage areas). As you move closer to the obstacle, the rate of the tone increases. When the obstacle is less than 10 inches (25.0 cm) away, the tone will sound continuously. If the RSS detects a stationary or receding object further than 10 inches (25.0 cm) from the side of the vehicle, the tone will sound for only three seconds. Once the system detects an object approaching, the tone will sound again.

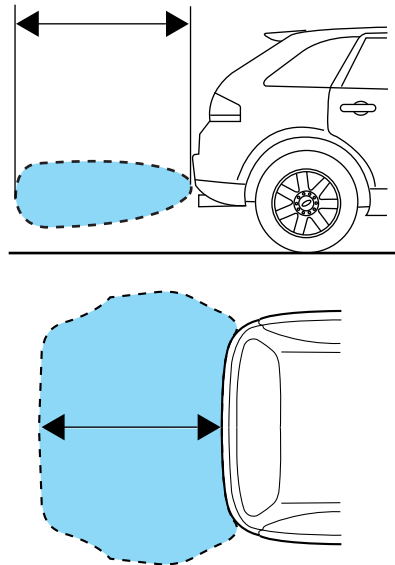

While receiving a warning the radio volume will be reduced to a predetermined level. After the warning goes away, the radio will return to the previous value.

The RSS automatically turns on when the gearshift lever is placed in R (Reverse) and the ignition is on. A control in the message center allows the driver to disable the system, refer to *Message center* in the *Instrument Cluster* chapter for more information.

Keep the RSS sensors (located on the rear bumper/fascia) free from snow, ice and large accumulations of dirt (do not clean the sensors with sharp objects). If the sensors are covered, it will affect the accuracy of the RSS.

If your vehicle sustains damage to the rear bumper/fascia, leaving it misaligned or bent, the sensing zone may be altered causing inaccurate measurement of obstacles or false alarms.

Driving

REARVIEW CAMERA SYSTEM (IF EQUIPPED)

The rear video camera system, located on the liftgate, provides a video image of the area behind the vehicle. It adds assistance to the driver while reversing or reverse parking the vehicle. To use the rear video camera system, place the transmission in R (Reverse). An image will display on the touchscreen display. The area displayed on the screen may vary according to the vehicle orientation and/or road condition.

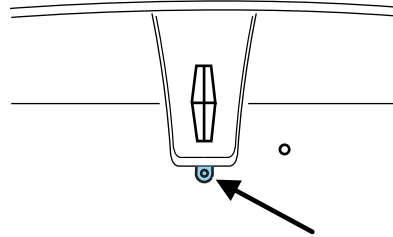

The rear video camera includes the following features that will assist the driver in reverse driving.

Fixed guidelines

The fixed guidelines assist a driver with backing into a parking space or aligning with an object behind the vehicle.

To turn this feature on or off when the vehicle is not in R (Reverse), do the following on the touchscreen:

1. Select Menu
2. Select Vehicle
3. Select Rear View Camera

The fixed guideline options are FIXED and OFF.

To turn this feature on or off when the vehicle is in R (Reverse), select Menu. The guideline options are the same as above.

- (1) Rear bumper
- (2) Red zone
- (3) Yellow zone
- (4) Green zone
- (5) Center line of vehicle

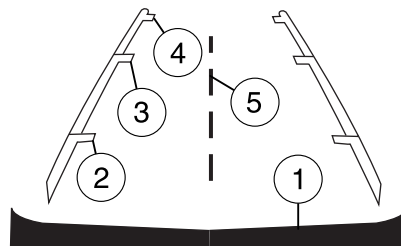

Always use caution while backing. Objects in the red zone (2) are closest to your vehicle and objects in the green zone (4) are further away.

232

Objects are getting closer to your vehicle as they move from the green zone (4) to the yellow (3) or red zones (2). Use the side mirrors and rearview mirror to get better coverage on both sides and rear of the vehicle.

Visual park aid alert (if equipped)

Visual park aid alert allows the driver to see the area that is causing the reverse sensing system to beep. The visual alerts are red, yellow or green highlights which appear on top of the video image when an object is detected by the reverse sensing system. The visual alert will highlight the closest object detected by the reverse sensing system. The reverse sensing alert can be disabled and if visual park aid alert is enabled, highlighted areas will still be displayed.

To turn this feature on or off when the vehicle is not in R (Reverse), do the following on the touchscreen:

1. Select Menu
2. Select Vehicle
3. Select Rear View Camera

The visual park aid alert options are ON and OFF.

To turn this feature on or off when the vehicle is in R (Reverse), select Menu. The visual park aid alert options are ON and OFF.

Note: The reverse sensing system is not effective at speeds above 3 mph (5 km/h) and may not detect certain angular or moving objects.

Manual zoom

The manual zoom feature assists drivers with connecting their vehicle to a trailer for the purpose of towing. It allows the driver to manually zoom closer to an object behind the vehicle. The zoomed image keeps the bumper in the image to provide a reference.

Press ▲ or ▼ to manually adjust the zoom levels. You can choose from OFF, Level 1, Level 2 and Level 3. The selected level will appear between the buttons (i.e. Level 1). When activating manual zoom mode, the system always starts from OFF.

When enabled, Level 1, Level 2, or Level 3 will only be active while the vehicle is in R (Reverse). The feature disables outside of R (Reverse) and must be re-enabled the next time the vehicle shifts into R (Reverse).

Driving

When manual zoom is enabled, only the centerline will be shown.

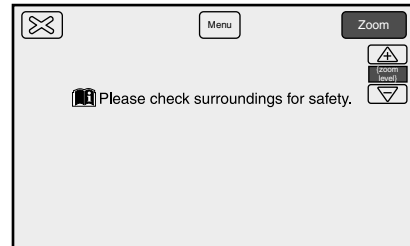

Rear camera delay

After shifting out of R (Reverse) and into any gear other than P (Park), the image will remain until the vehicle speed reaches five mph (8 km/h). This will only occur if the rear camera delay feature is on, or until any radio button is selected.

The default setting for the rear camera delay is ON. To turn this feature on or off when the vehicle is not in R (Reverse), do the following:

1. Select Menu
2. Select Vehicle
3. Select Rear View Camera

The rear camera delay options are ON and OFF.

To turn this feature on or off when the vehicle is in R (Reverse), select Menu. The rear camera delay options are ON and OFF. Refer to the touchscreen supplement for more information.

The camera lens for the reverse camera system is located on the liftgate. Keep the lens clean so the video image remains clear and undistorted. Clean the lens with a soft, lint-free cloth and non-abrasive cleaner.

When towing, the reverse camera system will only see what is being towed behind the vehicle. This might not provide adequate coverage as it usually provides in normal operation and some objects might not be seen.

Fixed guidelines, visual park aid alert and manual zoom features are only available when the vehicle is in R (Reverse).

If the vehicle is in R (Reverse) and the liftgate is ajar, no rear video camera features will be displayed. A message will be displayed on the touchscreen if the liftgate is ajar.

After activating or deactivating a rear video camera feature, the touchscreen will show a preview of the feature(s) selected.

234

Driving

Note: If the camera system image is not clear or seems distorted, it may be covered with water droplets, snow, mud or any other substance. If this occurs, clean the camera lens before using the camera system.



WARNING: The rearview camera system is a reverse aid supplement device that still requires the driver to use it in conjunction with the rearview mirror and the side mirrors for maximum coverage.



WARNING: Objects that are close to either corner of the bumper or under the bumper, might not be seen on the screen due to the limited coverage of the camera system.



WARNING: Backup as slow as possible since higher speeds might limit your reaction time to stop the vehicle.



WARNING: When manual zoom is enabled (Level 1, Level 2 or Level 3), the full area behind the vehicle will not be shown. Be aware of your surroundings when using the manual zoom feature.



WARNING: Use caution when using the rear video camera and the liftgate is ajar. If the liftgate is ajar, the camera will be out of position and the video image may be incorrect. All guidelines (if enabled) have been removed when the liftgate is ajar.



WARNING: Use caution when turning ON or OFF camera features while in R (Reverse). Make sure the vehicle is not moving.

If the back end of the vehicle is hit or damaged, then check with your authorized dealer to have your rear video system checked for proper coverage and operation.

Night time and dark area use

At night time or in dark areas, the camera system relies on the reverse lamp lighting to produce an image. Therefore, it is necessary that both reverse lamps are operating in order to get a clear image in the dark. If either of the lamps are not operating, stop using the camera system, at least in the dark, until the lamp(s) are replaced and functioning.

235

Driving

Servicing

- If the image comes on while the vehicle is not in R (Reverse), have the system inspected by your authorized dealer.
- If the image is not clear, check if anything is covering the lens such as dirt, mud, ice, snow, etc. If the image is still not clear after cleaning, have your system inspected by your authorized dealer.

COLLISION WARNING SYSTEM (IF EQUIPPED)

The collision warning with brake support, is designed to alert the driver of certain collision risks with a red warning light located above the dashboard and an audible warning chime. The brake support assists the driver in reducing the collision speed, by pre-charging the brakes.



WARNING: This system is designed to be a supplementary driving aid. It is not intended to replace the driver's attention, and judgment, or the need to apply the brakes. This system does NOT activate the brakes automatically. Failure to press the brake pedal to activate the brakes may result in a collision.



WARNING: The collision warning system with brake support cannot help prevent all collisions. Do not rely on this system to replace driver judgment and the need to maintain distance and speed.

Note: The collision warning with brake support will not detect, warn, or respond to potential collisions with vehicles to the rear or sides of the vehicle.

Operation

The radar sensor detects vehicles ahead that are moving in the same direction as your vehicle.

If the radar detects that your vehicle is rapidly closing on another vehicle a red warning light will illuminate and an audible warning chime will sound.

After that, if the risk of collision further increases after the warning light, the brake support prepares the brake system for rapid braking. This may be apparent to the driver. However, the system will not automatically activate the brakes.

The vehicle will not stop unless the driver presses the brake pedal. If the brake pedal is pressed then braking is implemented with full brake function, even if the force on the brake pedal is light.

The collision warning system is active at speeds above approximately 5 mph (8 km/h).

Collision warning system limitations

Due to the nature of radar technology, there may be certain instances where vehicles will not provide a collision warning. These include:

- Stationary or slow moving vehicles below 6 mph (10 km/h).
- Pedestrians or objects in the roadway.
- Oncoming vehicles in the same lane.
- Severe weather conditions (see also blocked sensor section).
- Debris build-up on the grille near the headlamps (see block sensor section).
- Small distance to vehicle ahead.
- Steering wheel and pedal movements are large (very active driving style).
- High interior temperatures, which may deactivate the illumination or the warning lamps until the interior temperature reduces (audible warning will alert the driver).

In addition, sun load and sunglasses may reduce the visibility of the warning lamps. Therefore, it is recommended to keep the audible warning on.

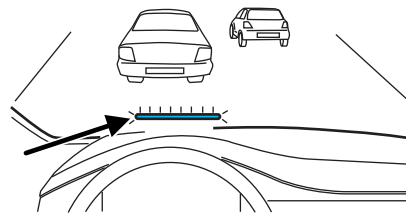
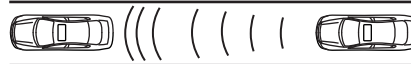

Driving



WARNING: The collision warning system's brake support can only help reduce the speed at which a collision occurs if the driver applies the vehicle's brakes. The brake pedal must be pressed just like for any typical braking situation.

Blocked sensor

If a message regarding a blocked sensor is displayed, the radar signals from the sensor, located behind a fascia cover near the driver side of the lower grille, have been obstructed. When the radar signals are obstructed, a vehicle ahead cannot be detected and the collision warning system will not function.

The following table lists possible causes and actions for this message being displayed.

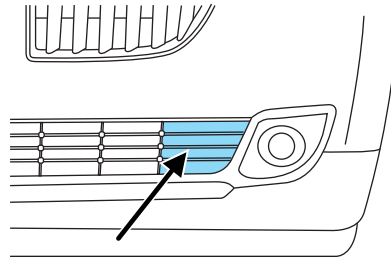

| Cause | Action |
|--|--|
| The surface of the radar in the grille is dirty or obstructed in some way | Clean the grille surface in front of the radar or remove the object causing the obstruction |
| The surface of the radar in the grille is clean but the message remains in the display | Wait a short time. It may take several minutes for the radar to detect that it is no longer obstructed |
| Heavy rain, spray, snow, or fog is interfering with the radar signals | The collision warning system is temporarily disabled. Collision warning should automatically reactivate a short time after the weather conditions improve. |
| Swirling water, or snow or ice on the surface of the road may interfere with the radar signals | The collision warning system is temporarily disabled. Collision warning should automatically reactivate a short time after the weather conditions improve. |

Activating/deactivating collision warning system

To turn the warning system and/or chime on or off and set the warning sensitivity <- ->, refer to *Message center* in the *Instrument Cluster* chapter.

238

Note: If the system cannot be turned off in a MyKey™ equipped vehicle, refer to *MyKey™* in the *Locks and Security* chapter for more information.

Note: If collision warnings are perceived as being too frequent or disturbing then the warning sensitivity can be reduced, though the manufacturer recommends using the highest sensitivity setting where possible. Setting lower sensitivity would lead to fewer and later system warnings. Refer to the *Message center* in the *Instrument Cluster* chapter for instructions on reducing the sensitivity.

BLIND SPOT MIRRORS (IF EQUIPPED)

Blind spot mirrors have an integrated convex spotter mirror built into the upper outboard corner of the outside mirrors. They are designed to assist the driver by increasing visibility along the side of the vehicle. For more information on your side view mirrors, refer to *Exterior mirrors* in the *Driver Controls* chapter.

Driving with blind spot mirrors

Before a lane change, check the main mirror first, then check the blind spot mirror. If no vehicles are present in the blind spot mirror and the traffic in the adjacent lane is at a safe distance, signal that you are going to change lanes. Glance over your shoulder to verify traffic is clear, and carefully change lanes.

When the approaching vehicle is at a distance, its image is small and near the inboard edge of the main mirror. As the vehicle approaches, the image becomes larger and begins to move outboard across the main mirror (1). As the vehicle approaches its image will transition from the main mirror and begin to appear in the blind spot mirror (2). As the vehicle leaves the blind spot mirror it will transition to the driver's peripheral field of view (3).

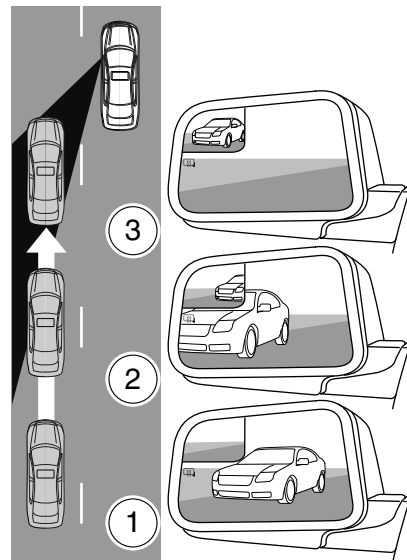

Driving



WARNING: Objects in the blind spot mirror are closer than they appear.

BLIND SPOT INFORMATION SYSTEM (BLIS®) WITH CROSS TRAFFIC ALERT (CTA) (IF EQUIPPED)

The BLIS® is a convenience feature that aids the driver in assessing whether a vehicle is within an area on either side of the vehicle extending rearward from the outside mirrors to approximately 10 feet (3 meters) beyond the bumper. This area is referred to as the blind zone. The BLIS® will alert the driver to the presence of motorized vehicles in these areas while driving on roads and freeways.

The system is not designed to prevent contact with other vehicles or objects. The system is designed to provide a warning to assist the driver in detecting vehicles in the blind zones. The system will not detect infrastructure, pedestrians, or cyclists.

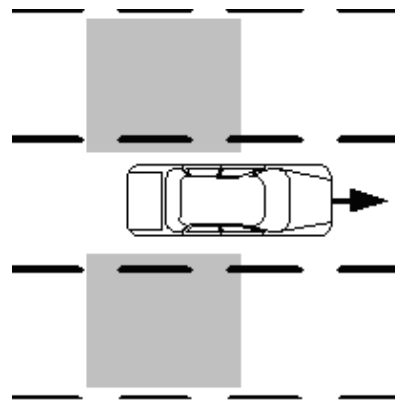

WARNING: To help avoid injuries, NEVER use the BLIS® as a replacement for using the side and rear view mirrors and looking over your shoulder before changing lanes. BLIS® is not a replacement for careful driving and only an assist.

The BLIS® and CTA has a yellow indicator (also referred to as the alert) located in the left and right exterior mirrors. When the vehicle is started, the BLIS® automatically illuminates both indicators for several seconds indicating the system is operating. The first time you place the transmission in D (Drive) after starting the engine and drive forward at a speed greater than 3 mph (5 km/h) the BLIS® system

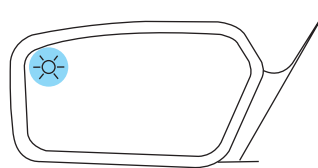

240

Driving

becomes active. Afterwards, the BLIS® remains active for all speeds including zero mph. BLIS® is also active if the transmission is placed in N (Neutral). If the transmission is shifted out of D (Drive) or N (Neutral) the system will enter the CTA mode (see CTA operation below). Once shifted back in to D (Drive) the BLIS® mode will activate once driven above 3 mph (5 km/h).

The BLIS® will trigger the alert for vehicles that enter your blind zone from the rear or merge in to the blind zone from the side. Vehicles that you pass, or a vehicle that enters the blind zone from the front, will trigger the alert only after the vehicle is present in the blind zone for three seconds. **Note:** For vehicles that pass through the blind zone quickly, typically less than two seconds, the BLIS® will not illuminate the alert.

The BLIS® consists of two radar sensors each located rearward of the rear wheels hidden behind the bumper fascia. Do not place any type of bumper sticker in this area.

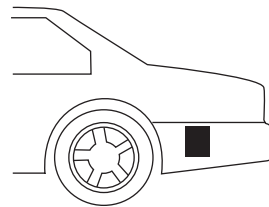

Note: The BLIS® typically will not detect parked vehicles, humans, animals, or infrastructure (fences, guard rails, trees, etc.). The BLIS®

does not function when the transmission is in R (Reverse) or P (Park). The BLIS® does not provide any additional warning when your turn signal is activated.

BLIS® detection limitations: Due to the nature of radar technology, there may be certain instances where vehicles entering and exiting the blind spot zones may not be detected. Below is a list of circumstances that may cause non-detection:

- Debris build-up on the rear quarter panel fascias
- Certain maneuvering of vehicles entering and exiting the blind zone
- Vehicles passing through the blind zone at very fast rates
- Severe weather conditions
- When several vehicles forming a convoy pass through the blind zone.

Driving

BLIS® False Alerts

Due to the nature of radar technology, there may be certain instances when the BLIS® will alert with no object present in the blind zone. This is known as a false alert. Some level of false alerts are normal.

Circumstances that may cause a false alert are guardrails, freeway concrete walls, cyclone fencing, sharp turns around a pole or building, or coming to a stop with a vehicle directly behind but very close. False alerts are temporary and self correct.

Cross traffic alert (CTA) system operation

The CTA system warns the driver of approaching vehicles when R (Reverse) is selected and the vehicle is backing out of a front-in parking spot. It sounds a series of tones and flashes the BLIS® indicator found on the exterior mirror on the side of the approaching vehicle. Additionally, the message center will display either, VEHICLE COMING FROM RIGHT or VEHICLE COMING FROM LEFT to warn the driver from which direction vehicles are approaching.

The system is not designed to prevent contact with other vehicles or objects. The system is designed to provide a warning to assist the driver in detecting vehicles in the blind zones. The system will not detect infrastructure, pedestrians, or bicyclists.



WARNING: To help avoid personal injury, NEVER use the CTA system as a replacement for using the side and rear view mirrors and looking over your shoulder before backing out of a parking space. CTA is not a replacement for careful driving and only an assist.

Driving

The CTA system detects vehicles approaching up to 45 feet (14 meters) away. Coverage decreases when vehicles and objects in close proximity block the CTA sensors (refer to figure for approximate zone coverage areas **[sensor obstructed for vehicle on left]**). Backing slowly from the parking spot in these situations helps to increase the sensor coverage and effectiveness.

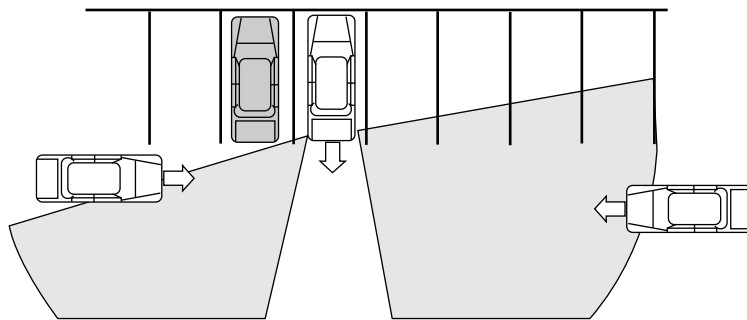

CTA coverage also decreases when parking at shallow angles (refer to figure for approximate zone coverage areas **[sensor obstructed for vehicle on left]**).

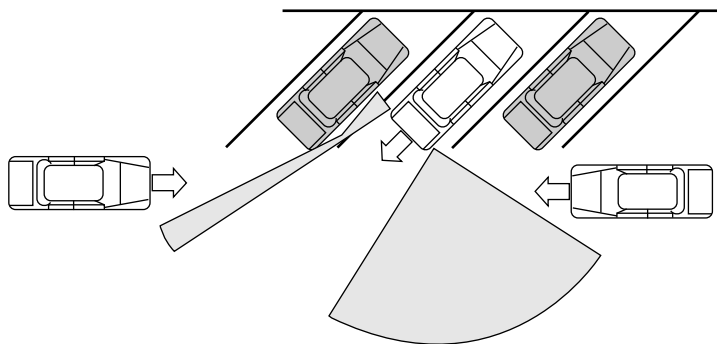

Driving

CTA detection limitations: Due to the nature of radar technology, there may be certain instances where vehicles entering and exiting the blind spot zones may not be detected. Below is a list of circumstances that may cause non-detection:

- Debris build-up on the rear quarter panel fascias
- The rear quarter panel radar beams are obstructed or partially obstructed by an adjacently parked vehicle or object.
- Approaching vehicles passing at speeds greater than 15 mph (24 km/h)
- Severe weather conditions
- Driving in reverse faster than 3 mph (5 km/h)
- Backing out of an angled parking spot

CTA false alerts

Due to the nature of radar technology, there may be certain instances when the BLIS® will alert with no object present when backing up. This is known as a false alert. Some level of false alerts are normal. Circumstances that may cause a false alert when backing up are backing out of a garage, backing in to a parking space, and objects very close to the sensor. False alerts are temporary and self correct.

CTA and reverse sensing system (RSS) interaction

CTA works along with the reverse sensing system (RSS) (if equipped). Become familiar with the warning tones of both systems.

BLIS® and/or CTA on/off and disable operation

The BLIS® and/or the CTA can be turned off via the message center. If either the BLIS® and/or the CTA is turned off, the systems will automatically turn back on at the next ignition key cycle. When either the BLIS® and/or the CTA is turned off, the message center displays BLIND SPOT SYS OFF and/or CTA SYSTEM OFF. When the BLIS® and/or the CTA system is off, the driver will not receive alerts. Refer to *Message center* in the *Instrument Cluster* chapter.

Note: If the system cannot be turned off, refer to *MyKey™* in the *Locks and Security* chapter for more information.

The BLIS® and/or the CTA can be disabled permanently even after an ignition key cycle. This must be done by your authorized dealer. **Note:** Once either of the systems are disabled, enabling must also be performed at the dealership. When disabled, the message center will display BLIND SPOT DISABLED and/or CTA DISABLED.

244

BLIS® and/or CTA fault operation

If the BLIS® and/or CTA senses a fault on either the left or right sensor, the BLIS® alert indicator will go on and remain on and the message center will display BLIND SPOT SYSTEM FAULT or CROSS TRAFFIC SYSTEM FAULT. For faults that may cause the associated left or right alert indicator not to illuminate, only the message center faults will occur.

Blocked sensor

An extreme build-up of materials on the quarter panel fascias such as mud or snow can cause degraded performance of the BLIS®. Also, heavy rain can cause the same effect. The BLIS® can detect this degraded performance and issue a blocked warning to the driver via the message center. If a condition is determined by the system, the message center displays BLIND SPOT NOT AVAILABLE or CROSS TRAFFIC NOT AVAILABLE warning and the appropriate left and/or right exterior mirror alert indicator will illuminate. The message center warning may be cleared by the driver but the exterior mirror alert indicator will remain illuminated.

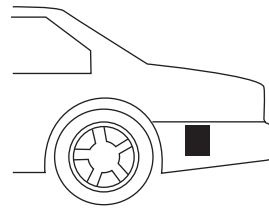

WARNING: Just prior to the system recognizing a blocked condition and alerting the driver, the number of missed objects will increase. To help avoid injuries, NEVER use the BLIS® as a replacement for using the side and rear view mirrors and looking over your shoulder before changing lanes. BLIS® is not a replacement for careful driving and only an assist.

Once the blockage is removed, the system will require some driving time and detection of at least two vehicle objects prior to resetting or the driver can cycle the ignition key. If, however, blockage is still present after the key cycle, the system will sense again that it is blocked after driving in traffic.

Driving

The following table lists possible causes and actions for this message being displayed:

| | |
|--|--|
| The surface of the radar is dirty or obstructed in some way | Clean the fascia area in front of the radar, either side, or remove obstruction. |
| The surface of the radar is not dirty or obstructed | Drive normally in traffic for a few minutes to allow the radar to detect that it is no longer blocked. Note: The vehicle must be in D (Drive) and a few vehicles must pass so that the BLIS® can clear a blocked state. |
| Heavy rainfall or heavy snowfall is interfering with the radar signals | No action required by the driver. The system will automatically reset to an unblocked state once the rainfall/snowfall rate decreases or stops. Do not use BLIS® and/or CTA in heavy rainfall or heavy snowfall. |

Due to the nature of radar technology, it is possible to get a blockage warning and not be blocked. This is rare and known as a false blockage warning. A false blocked condition will either self clear or clear after a key cycle.

Trailer tow false alerts

When towing a trailer, the sensors may detect the trailer thus causing a false alert. It may be desirable to turn the BLIS® off if the false alerts become annoying.

Day and night brightness

The BLIS® and/or CTA alert will automatically dim when the headlamp switch is in PARK, ON, or AUTO ON and night time darkness has been detected by the sun sensor.

ALL WHEEL DRIVE (AWD) SYSTEM (IF EQUIPPED)

Your vehicle may be equipped with a full-time all-wheel drive (AWD) system. The AWD system is an active system, meaning it not only responds to wheel slip between the front and rear axles but also has the ability to anticipate wheel slip and transfer torque to the rear wheels before slip occurs. The AWD system is active all the time and requires no input from the operator.

246

All components of the AWD system are sealed for life and require no maintenance.

Note: When an AWD system fault is present, the warning **CHECK AWD** will display in the message center. The AWD system is not functioning correctly and defaulted to front-wheel drive. When this warning is displayed, have your vehicle serviced at an authorized dealer

If your vehicle is equipped with AWD, a spare tire of a different size other than the tire provided should never be used. If the spare tire is installed, the AWD system may disable automatically and enter front-wheel drive only mode to protect driveline components. This condition may be indicated by an **AWD OFF** message in the message center (see *Message center* section in the *Instrument Cluster* chapter for more information). If there is an **AWD OFF** message in the message center from using the spare tire, this indicator should turn off after reinstalling the repaired or replaced normal road tire and driving a short distance. It is recommended to reinstall the repaired or replaced road tire as soon as possible. Major dissimilar tire sizes between the front and rear axles could cause the AWD system to stop functioning and default to front-wheel drive or damage the AWD system.

Note: The **AWD OFF** message may also be displayed in the message center if the AWD system has overheated and defaulted to front-wheel drive. This condition may occur if the vehicle was operated in extreme conditions with excessive wheel slip, such as deep sand. To resume normal AWD function as soon as possible, stop the vehicle in a safe location and allow it to idle. The **AWD OFF** message will turn off when the system cools and normal AWD function returns.

Note: The AWD feature gives your vehicle some limited off-road capabilities in which driving surfaces are relatively level, obstruction-free and otherwise similar to normal on-road driving conditions. Operating your vehicle under other than those conditions could subject the vehicle to excessive stress which might result in damage which is not covered under your warranty.

Driving off-highway with AWD vehicles

AWD vehicles are equipped for driving on sand, snow, mud and rough roads and have operating characteristics that are somewhat different from conventional vehicles, both on and off the highway.

When driving at slow speeds off-highway under high outside temperatures, use L (Low) gear when possible. L (Low) gear operation will maximize the engine and transmission cooling capability.

Driving

Under severe operating conditions, the A/C may cycle on and off to protect overheating of the engine.

Basic operating principles

- Drive slower in strong crosswinds which can affect the normal steering characteristics of your vehicle.
- Be extremely careful when driving on pavement made slippery by loose sand, water, gravel, snow or ice.

If your vehicle goes off the edge of the pavement

- If your vehicle goes off the edge of the pavement, slow down, but avoid severe brake application, ease the vehicle back onto the pavement only after reducing your speed. Do not turn the steering wheel too sharply while returning to the road surface.
- It may be safer to stay on the apron or shoulder of the road and slow down gradually before returning to the pavement. You may lose control if you do not slow down or if you turn the steering wheel too sharply or abruptly.
- It often may be less risky to strike small objects, such as highway reflectors, with minor damage to your vehicle rather than attempt a sudden return to the pavement which could cause the vehicle to slide sideways out of control or rollover. Remember, your safety and the safety of others should be your primary concern.

If your vehicle gets stuck

If your vehicle gets stuck in mud or snow it may be rocked out by shifting between forward and reverse gears, stopping between shifts, in a steady pattern. Press lightly on the accelerator in each gear.

If your vehicle is equipped with AdvanceTrac® with Roll Stability Control™, it may be beneficial to disengage the AdvanceTrac® with Roll Stability Control™ system while attempting to rock the vehicle.

Do not rock the vehicle if the engine is not at normal operating temperature or damage to the transmission may occur.

Do not rock the vehicle for more than a few minutes or damage to the transmission and tires may occur or the engine may overheat.



WARNING: Always set the parking brake fully and make sure the gearshift is latched in P (Park). Turn the ignition to the LOCK position and remove the key whenever you leave your vehicle.

Driving



WARNING: If the parking brake is fully released, but the brake warning lamp remains illuminated, the brakes may not be working properly. See your authorized dealer.



WARNING: Do not spin the wheels at over 35 mph (56 km/h). The tires may fail and injure a passenger or bystander.

Emergency maneuvers

- In an unavoidable emergency situation where a sudden sharp turn must be made, remember to avoid “over-driving” your vehicle (i.e., turn the steering wheel only as rapidly and as far as required to avoid the emergency). Excessive steering will result in less vehicle control, not more. Additionally, smooth variations of the accelerator and/or brake pedal pressure should be utilized if changes in vehicle speed are called for. Avoid abrupt steering, acceleration or braking which could result in an increased risk of loss of vehicle control, vehicle rollover and/or personal injury. Use all available road surface to return the vehicle to a safe direction of travel.
- In the event of an emergency stop, avoid skidding the tires and do not attempt any sharp steering wheel movements.
- If the vehicle goes from one type of surface to another (i.e., from concrete to gravel) there will be a change in the way the vehicle responds to a maneuver (steering, acceleration or braking). Again, avoid these abrupt inputs.

AWD systems (if equipped)

With AWD, the vehicle uses all four wheels to power the vehicle. This increases traction, enabling you to drive over terrain and road conditions that a conventional two-wheel drive vehicle cannot.

Sand

When driving over sand, try to keep all four wheels on the most solid area of the trail. Avoid reducing the tire pressures but shift to a lower gear and drive steadily through the terrain. Apply the accelerator slowly and avoid spinning the wheels.

Do not drive your AWD vehicle in deep sand for an extended period of time. This will cause the AWD system to overheat. If the rear tires stop spinning while the front tires spin in deep sand, turn off the vehicle and allow the AWD system to cool down for a minimum of 15 minutes. After

249

Driving

the system has cooled down, normal AWD function will return. When driving at slow speeds in deep sand under high outside temperatures, use L (Low) gear when possible. L (Low) gear operation will maximize the engine and transmission cooling capability.

Under severe operating conditions, the A/C may cycle on and off to protect overheating of the engine.

Avoid excessive speed because vehicle momentum can work against you and cause the vehicle to become stuck to the point that assistance may be required from another vehicle. Remember, you may be able to back out the way you came if you proceed with caution.

Mud and water

If you must drive through high water, drive slowly. Traction or brake capability may be limited.

When driving through water, determine the depth; avoid water higher than the bottom of the wheel rims (for cars) or the bottom of the hubs (for trucks) (if possible) and proceed slowly. If the ignition system gets wet, the vehicle may stall.

Once through water, always try the brakes. Wet brakes do not stop the vehicle as effectively as dry brakes. Drying can be improved by moving your vehicle slowly while applying light pressure on the brake pedal.

Be cautious of sudden changes in vehicle speed or direction when you are driving in mud. Even AWD vehicles can lose traction in slick mud. As when you are driving over sand, apply the accelerator slowly and avoid spinning your wheels. If the vehicle does slide, steer in the direction of the slide until you regain control of the vehicle.

After driving through mud, clean off residue stuck to rotating driveshafts and tires. Excess mud stuck on tires and rotating driveshafts causes an imbalance that could damage drive components.

Driving through deep water may damage the transmission.

If the front or rear axle is submerged in water, the axle lubricant and PTU (power transfer unit) lubricant should be checked and changed if necessary.

“Tread Lightly” is an educational program designed to increase public awareness of land-use regulations and responsibilities in our nations wilderness areas. Ford Motor

Company joins the U.S. Forest Service and the Bureau of Land

250



Driving

Management is encouraging you to help preserve our national forest and other public and private lands by “treading lightly.”

Driving on hilly or sloping terrain

Although natural obstacles may make it necessary to travel diagonally up or down a hill or steep incline, you should always try to drive straight up or straight down. **Avoid driving crosswise or turning on steep slopes or hills.** A danger lies in losing traction, slipping sideways and possibly rolling over. Whenever driving on a hill, determine beforehand the route you will use. Do not drive over the crest of a hill without seeing what conditions are on the other side. Do not drive in reverse over a hill without the aid of an observer.

When climbing a steep slope or hill, start in a lower gear rather than downshifting to a lower gear from a higher gear once the ascent has started. This reduces strain on the engine and the possibility of stalling.

If you do stall out, do not try to turnaround because you might roll over. It is better to back down to a safe location.

Apply just enough power to the wheels to climb the hill. Too much power will cause the tires to slip, spin or lose traction, resulting in loss of vehicle control.

Descend a hill in the same gear you would use to climb up the hill to avoid excessive brake application and brake overheating. Do not descend in neutral; instead, disengage overdrive or manually shift to a lower gear. When descending a steep hill, avoid sudden hard braking as you could lose control. The front wheels have to be turning in order to steer the vehicle.

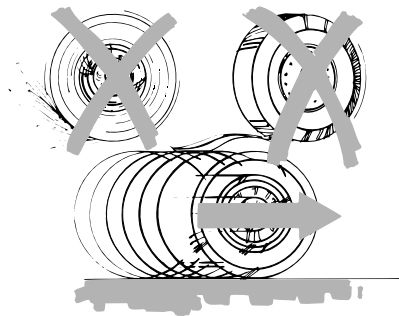

Your vehicle has anti-lock brakes, therefore apply the brakes steadily. Do not “pump” the brakes.

Driving on snow and ice

Note: Excessive tire slippage can cause transmission damage.

AWD vehicles have advantages over 2WD vehicles in snow and ice but can skid like any other vehicle.

Should you start to slide while driving on snowy or icy roads, turn the steering wheel in the direction of the slide until you regain control.

Driving

Avoid sudden applications of power and quick changes of direction on snow and ice. Apply the accelerator slowly and steadily when starting from a full stop.

Avoid sudden braking as well. Although an AWD vehicle may accelerate better than a two-wheel drive vehicle in snow and ice, it won't stop any faster, because as in other vehicles, braking occurs at all four wheels. Do not become overconfident as to road conditions.

Make sure you allow sufficient distance between you and other vehicles for stopping. Drive slower than usual and consider using one of the lower gears. In emergency stopping situations, apply the brake steadily. Since your vehicle is equipped with a four wheel anti-lock brake system (ABS), do not "pump" the brakes. Refer to the *Brakes* section of this chapter for additional information on the operation of the anti-lock brake system.



WARNING: If you are driving in slippery conditions that require tire chains or cables, then it is critical that you drive cautiously. Keep speeds down, allow for longer stopping distances and avoid aggressive steering to reduce the chances of a loss of vehicle control which can lead to serious injury or death. If the rear end of the vehicle slides while cornering, steer in the direction of the slide until you regain control of the vehicle.

Maintenance and modifications

The suspension and steering systems on your vehicle have been designed and tested to provide predictable performance whether loaded or empty and durable load carrying capability. For this reason, Ford Motor Company strongly recommends that you do not make modifications such as adding or removing parts (such as lift kits or stabilizer bars) or by using replacement parts not equivalent to the original factory equipment.

Any modifications to a vehicle that raise the center of gravity can make it more likely the vehicle will rollover as a result of a loss of control. Ford Motor Company recommends that caution be used with any vehicle equipped with a high load or device (such as ladder or luggage racks).

Failure to maintain your vehicle properly may void the warranty, increase your repair cost, reduce vehicle performance and operational capabilities and adversely affect driver and passenger safety. Frequent inspection of vehicle chassis components is recommended if the vehicle is subjected to off-highway usage.

252

DRIVING THROUGH WATER

If driving through deep or standing water is unavoidable, proceed very slowly especially when the depth is not known. Never drive through water that is higher than the bottom of the wheel rims (for cars) or the bottom of the hubs (for trucks).

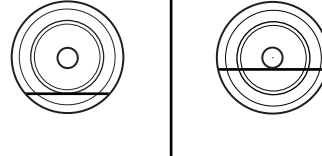

When driving through water, traction or brake capability may be limited. Also, water may enter your engine's air intake and severely damage your engine or your vehicle may stall. **Driving through deep water where the transmission vent tube is submerged may allow water into the transmission and cause internal transmission damage.**

Once through the water, always dry the brakes by moving your vehicle slowly while applying light pressure on the brake pedal. Wet brakes do not stop the vehicle as quickly as dry brakes.

Roadside Emergencies

ROADSIDE ASSISTANCE

Getting roadside assistance

To fully assist you should you have a vehicle concern, Ford Motor Company offers a complimentary roadside assistance program. This program is separate from the New Vehicle Limited Warranty. The service is available:

- 24-hours, seven days a week
- for the coverage period listed on the Roadside Assistance Card included in your Owner Guide portfolio.

Roadside assistance will cover:

- a flat tire change with a good spare (except vehicles that have been supplied with a tire inflation kit)
- battery jump start
- lock-out assistance (key replacement cost is the customer's responsibility)
- fuel delivery – Independent Service Contractors, if not prohibited by state, local or municipal law shall deliver up to 2.0 gallons (7.5L) of gasoline or 5.0 gallons (18.9L) of diesel fuel to a disabled vehicle. Fuel delivery service is limited to two no-charge occurrences within a 12-month period.
- winch out – available within 100 feet (30.5 meters) of a paved or county maintained road, no recoveries.
- towing – Ford/Mercury/Lincoln eligible vehicle towed to an authorized dealer within 35 miles (56 km) of the disablement location or to the nearest authorized dealer. If a member requests to be towed to an authorized dealer more than 35 miles (56 km) from the disablement location, the member shall be responsible for any mileage costs in excess of 35 miles (56 km).

Trailers shall be covered up to \$200 if the disabled eligible vehicle requires service at the nearest authorized dealer. If the trailer is disabled, but the towing vehicle is operational, the trailer does not qualify for any roadside services.

Canadian customers refer to your Warranty Guide or visit our website at www.ford.ca for information on:

Using roadside assistance

Complete the roadside assistance identification card and place it in your wallet for quick reference. In the United States, this card is found in the

254

Roadside Emergencies

Owner Guide portfolio in the glove compartment. In Canada, the card is found in the *Warranty Guide* in the glove compartment.

U.S. Ford, Mercury and Lincoln vehicle customers who require Roadside Assistance, call 1-800-241-3673.

Canadian customers who require roadside assistance, call 1-800-665-2006.

If you need to arrange roadside assistance for yourself, Ford Motor Company will reimburse a reasonable amount for towing to the nearest dealership within 35 miles (56 km). To obtain reimbursement information, U.S. Ford, Mercury and Lincoln vehicle customers call 1-800-241-3673. Customers will be asked to submit their original receipts.

Canadian customers who need to obtain reimbursement information, call 1-800-665-2006 or visit our website at www.ford.ca.

HAZARD FLASHER CONTROL

The hazard flasher control is located on the instrument panel by the radio. The hazard flashers will operate when the ignition is in any position or if the key is not in the ignition.



Press the flasher control and all front and rear direction signals will flash. Press the flasher control again to turn them off. Use it when your vehicle is disabled and is creating a safety hazard for other motorists.

Note: With extended use, the flasher may run down your battery.

FUEL PUMP SHUT-OFF

In the event of a moderate to severe collision, this vehicle is equipped with a fuel pump shut-off feature that stops the flow of fuel to the engine. Not every impact will cause a shut-off.

Should your vehicle shut off after a collision due to this feature, you may restart your vehicle by doing the following:

1. Turn the ignition switch to the off position.
2. Turn the ignition switch to the on position.

In some instances the vehicle may not restart the first time you try to restart and may take one additional attempt.

255

Roadside Emergencies



WARNING: Failure to inspect and if necessary repair fuel leaks after a collision may increase the risk of fire and serious injury. Ford Motor Company recommends that the fuel system be inspected by an authorized dealer after any collision.

FUSES AND RELAYS

Fuses

If electrical components in the vehicle are not working, a fuse may have blown. Blown fuses are identified by a broken wire within the fuse. Check the appropriate fuses before replacing any electrical components.

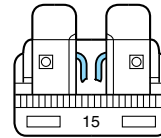

Note: Always replace a fuse with one that has the specified amperage rating. Using a fuse with a higher amperage rating can cause severe wire damage and could start a fire.

Standard fuse amperage rating and color

| COLOR | | | | | |
|-------------|------------|----------------|------------|----------------------|---------------------|
| Fuse rating | Mini fuses | Standard fuses | Maxi fuses | Cartridge maxi fuses | Fuse link cartridge |
| 2A | Grey | Grey | — | — | — |
| 3A | Violet | Violet | — | — | — |
| 4A | Pink | Pink | — | — | — |
| 5A | Tan | Tan | — | — | — |
| 7.5A | Brown | Brown | — | — | — |
| 10A | Red | Red | — | — | — |
| 15A | Blue | Blue | — | — | — |
| 20A | Yellow | Yellow | Yellow | Blue | Blue |
| 25A | Natural | Natural | — | — | — |
| 30A | Green | Green | Green | Pink | Pink |
| 40A | — | — | Orange | Green | Green |
| 50A | — | — | Red | Red | Red |

256

Roadside Emergencies

| COLOR | | | | | |
|-------------|------------|----------------|------------|----------------------|---------------------|
| Fuse rating | Mini fuses | Standard fuses | Maxi fuses | Cartridge maxi fuses | Fuse link cartridge |
| 60A | — | — | Blue | Yellow | Yellow |
| 70A | — | — | Tan | — | Brown |
| 80A | — | — | Natural | Black | Black |

Passenger compartment fuse panel

The fuse panel is located behind a trim panel on the left side of the driver's footwell near the parking brake. To remove the trim panel, slide the release lever to the right then pull the trim panel out.

To remove the fuse panel cover, press in the tabs on both sides of the cover, then pull the cover off.

To reinstall the fuse panel cover, place the top part of the cover on the fuse panel, then push the bottom part of the cover until it clicks into place. Gently pull on the cover to make sure it is secure.

To reinstall the trim panel, align the tabs on the bottom of the panel with the grooves, push the panel shut and slide the release lever to the left to secure the panel.

To remove a fuse, use the fuse puller tool provided on the fuse panel cover.

Roadside Emergencies

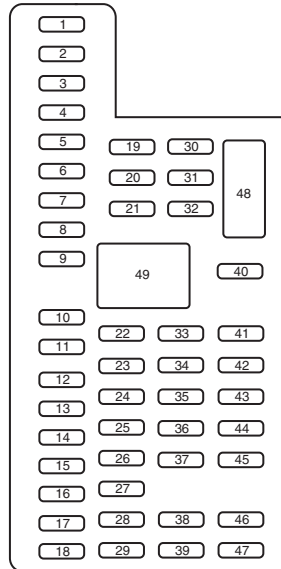

The fuses are coded as follows.

| Fuse/Relay Location | Fuse Amp Rating | Protected Circuits |
|---------------------|-----------------|---|
| 1 | 30A | Driver front smart window |
| 2 | 15A | Not used (spare) |
| 3 | 30A | Passenger front smart window |
| 4 | 10A | Demand lamps |
| 5 | 20A | Subwoofer |
| 6 | 5A | RF module |
| 7 | 7.5A | Power mirror switch, Memory seat switch, Driver seat module |
| 8 | 10A | Not used (spare) |
| 9 | 10A | Power liftgate |
| 10 | 10A | Run/accessory relay |
| 11 | 10A | Instrument panel cluster, Heads-up display |

258

Roadside Emergencies

| Fuse/Relay Location | Fuse Amp Rating | Protected Circuits |
|---------------------|-----------------|---|
| 12 | 15A | Interior lighting, Puddle lamps, Backlighting |
| 13 | 15A | Right turn/stop lamps and turn signals |
| 14 | 15A | Left turn/stop lamps and turn signals |
| 15 | 15A | Reverse lamps, Stop lamps (high-mounted) |
| 16 | 10A | Low beam headlamps (right) |
| 17 | 10A | Low beam headlamps (left) |
| 18 | 10A | Keypad illumination, Brake shift interlock (BSI), Passenger compartment fuse panel, Start button LED, Passive anti-theft system (PATS), Powertrain control module (PCM) wake-up, 2nd row power enable |
| 19 | 20A | Audio amplifier |
| 20 | 20A | Lock/unlock relays – vehicles without intelligent access (IA) |
| 21 | 10A | Not used (spare) |
| 22 | 20A | Horn relay |
| 23 | 15A | Steering wheel control, IA, Headlamp switch |
| 24 | 15A | Power tilt/telescope steering column, On-board diagnostics (OBDII) |
| 25 | 15A | Liftgate release |
| 26 | 5A | Global positioning system (GPS) module |
| 27 | 20A | IA |
| 28 | 15A | Ignition switch (without IA), Key inhibit solenoid, Push button start (with IA) |
| 29 | 20A | Radio, Electronic finish panel, SYNC® module |
| 30 | 15A | Front park lamps |
| 31 | 5A | Not used (spare) |

Roadside Emergencies

| Fuse/Relay Location | Fuse Amp Rating | Protected Circuits |
|---------------------|---------------------|--|
| 32 | 15A | Moon roof, Power windows, Compass/auto-dimming rear view mirror |
| 33 | 10A | Not used (spare) |
| 34 | 10A | Reverse sensing system, Rearview camera, Blind spot monitor, Rear heated seat module |
| 35 | 5A | Heads-up display |
| 36 | 10A | Heated steering wheel |
| 37 | 10A | Climate control |
| 38 | 10A | Not used (spare) |
| 39 | 15A | High beam headlamps |
| 40 | 10A | Rear park lamps |
| 41 | 7.5A | Occupant classification sensor (OCS), Restraints control module |
| 42 | 5A | Not used (spare) |
| 43 | 10A | Not used (spare) |
| 44 | 10A | Not used (spare) |
| 45 | 5A | Not used (spare) |
| 46 | 10A | Climate control |
| 47 | 15A | Fog lamps |
| 48 | 30A Circuit Breaker | Power windows/moon roof |
| 49 | — | Delayed accessory relay |

Power distribution box

The power distribution box is located in the engine compartment. The power distribution box contains high-current fuses that protect your vehicle's main electrical systems from overloads.



WARNING: Always disconnect the battery before servicing high current fuses.

Roadside Emergencies



WARNING: To reduce risk of electrical shock, always replace the cover to the power distribution box before reconnecting the battery or refilling fluid reservoirs.

If the battery has been disconnected and reconnected, refer to the *Battery* section of the *Maintenance and Specifications* chapter.

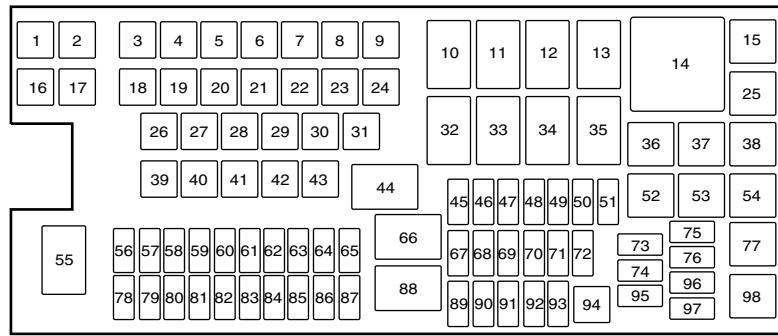

The high-current fuses are coded as follows:

| Fuse/Relay Location | Fuse Amp Rating | Power Distribution Box Description |
|---------------------|-----------------|---|
| 1 | — | Not used |
| 2 | — | Not used |
| 3 | — | Not used |
| 4 | 30A** | Wipers |
| 5 | 40A** | Anti-lock brake system (ABS) pump |
| 6 | — | Not used |
| 7 | 30A** | Power liftgate |
| 8 | 20A** | Moon roof |
| 9 | 20A** | Power point #2 (console rear) |
| 10 | — | Not used |
| 11 | — | Rear window defroster/heated mirror relay |

Roadside Emergencies

| Fuse/Relay Location | Fuse Amp Rating | Power Distribution Box Description |
|---------------------|-----------------|--|
| 12 | — | Not used |
| 13 | — | Starter relay |
| 14 | — | Not used |
| 15 | — | Fuel pump relay |
| 16 | — | Not used |
| 17 | — | Not used |
| 18 | 40A** | Blower motor |
| 19 | 30A** | Starter motor |
| 20 | 20A** | Power point #1 (console bin) |
| 21 | 20A** | Cargo area power point |
| 22 | — | Not used |
| 23 | 30A** | Driver seat module |
| 24 | — | Not used |
| 25 | — | Not used |
| 26 | 40A** | Rear window defroster |
| 27 | 20A** | Front power point/lighter |
| 28 | 30A** | Climate controlled seats |
| 29 | — | Not used |
| 30 | 30A** | Rear heated seats |
| 31 | — | Not used |
| 32 | — | Not used |
| 33 | — | Not used |
| 34 | — | Blower motor relay |
| 35 | — | Not used |
| 36 | — | Rear seat relay |
| 37 | — | Right trailer tow (TT) stop/turn lamps relay |
| 38 | — | Not used |
| 39 | 40A** | Cooling fan (vehicles with TT) |
| | 60A** | Cooling fan (vehicles without TT) |
| 40 | 40A** | Cooling fan (TT only) |

Roadside Emergencies

| Fuse/Relay Location | Fuse Amp Rating | Power Distribution Box Description |
|---------------------|-----------------|---|
| 41 | — | Not used |
| 42 | 30A** | Passenger seat |
| 43 | 30A** | ABS valves |
| 44 | — | Rear washer relay |
| 45 | 5A* | Rain sensor |
| 46 | — | Not used |
| 47 | — | Not used |
| 48 | — | Not used |
| 49 | — | Not used |
| 50 | 15A* | Heated mirror |
| 51 | — | Not used |
| 52 | — | Not used (spare) |
| 53 | — | Left TT stop/turn lamps relay |
| 54 | — | Not used |
| 55 | — | Wiper relay |
| 56 | — | Not used |
| 57 | 20A* | Left high-intensity discharge (HID) headlamps |
| 58 | 10A* | Alternator sensor |
| 59 | 10A* | Brake on/off switch |
| 60 | — | Not used |
| 61 | 10A* | Rear seat release |
| 62 | 10A* | A/C clutch |
| 63 | 15A* | TT stop/turn lamps relay |
| 64 | 20A* | Rear wiper motor |
| 65 | 15A* | Fuel pump |
| 66 | — | Powertrain control module (PCM) relay |
| 67 | 20A* | Vehicle power (VPWR) #2 |
| 68 | 15A* | VPWR #4 |
| 69 | 15A* | VPWR #1 |
| 70 | 10A* | A/C relay, All-wheel drive module |

Roadside Emergencies

| Fuse/Relay Location | Fuse Amp Rating | Power Distribution Box Description |
|---------------------|-----------------|--|
| 71 | — | Not used |
| 72 | — | Not used |
| 73 | — | Not used |
| 74 | — | Not used |
| 75 | — | A/C clutch diode |
| 76 | — | Not used |
| 77 | — | TT park lamps relay |
| 78 | 20A* | Right HID headlamps |
| 79 | 5A* | Adaptive cruise control |
| 80 | — | Not used |
| 81 | — | Not used |
| 82 | 15A* | Rear washer |
| 83 | — | Not used |
| 84 | 20A* | TT park lamps |
| 85 | — | Not used |
| 86 | 7.5A* | PCM keep-alive, PCM relay |
| 87 | 5A* | Run/start relay |
| 88 | — | Run/start relay |
| 89 | 5A* | Adaptive lighting |
| 90 | 10A* | PCM |
| 91 | 10A* | Adaptive cruise control |
| 92 | 10A* | ABS module |
| 93 | 5A* | Blower motor/rear defroster relay |
| 94 | 30A** | Passenger compartment fuse panel run/start |
| 95 | — | Not used |
| 96 | — | Not used |
| 97 | — | Not used |
| 98 | — | A/C clutch relay |

* Mini Fuses ** Cartridge Fuses

Roadside Emergencies

CHANGING THE TIRES

If you get a flat tire while driving, do not apply the brake heavily. Instead, gradually decrease your speed. Hold the steering wheel firmly and slowly move to a safe place on the side of the road.

Note: The tire pressure monitoring system (TPMS) indicator light will illuminate when the spare tire is in use. To restore the full functionality of the monitoring system, all road wheels equipped with tire pressure monitoring sensors must be mounted on the vehicle.

Have a flat serviced by an authorized dealer in order to prevent damage to the TPMS sensors, refer to *Tire pressure monitoring system (TPMS)* in the *Tires, Wheels and Loading* chapter. Replace the spare tire with a road tire as soon as possible. During repairing or replacing of the flat tire, have the authorized dealer inspect the TPMS sensor for damage.



WARNING: The use of tire sealants may damage your tire pressure monitoring system (TPMS) and should not be used. However, if you must use a sealant, the TPMS sensor and valve stem on the wheel must be replaced by an authorized Ford dealer.



WARNING: Refer to *Tire pressure monitoring system (TPMS)* in the *Tires, Wheels and Loading* chapter for important information. If the tire pressure monitor sensor becomes damaged, it will no longer function.

Dissimilar spare tire/wheel information



WARNING: Failure to follow these guidelines could result in an increased risk of loss of vehicle control, injury or death.

If you have a dissimilar spare tire/wheel, then it is intended for temporary use only. This means that if you need to use it, you should replace it as soon as possible with a road tire/wheel that is the same size and type as the road tires and wheels that were originally provided by Ford. If the dissimilar spare tire or wheel is damaged, it should be replaced rather than repaired.

Roadside Emergencies

A dissimilar spare tire/wheel is defined as a spare tire and/or wheel that is different in brand, size or appearance from the road tires and wheels and can be one of three types:

1. **T-type mini-spare:** This spare tire begins with the letter “T” for tire size and may have “Temporary Use Only” molded in the sidewall
2. **Full-size dissimilar spare with label on wheel:** This spare tire has a label on the wheel that states: “THIS TIRE AND WHEEL FOR TEMPORARY USE ONLY”

When driving with one of the dissimilar spare tires listed above, **do not:**

- Exceed 50 mph (80 km/h)
- Load the vehicle beyond maximum vehicle load rating listed on the Safety Compliance Label
- Tow a trailer
- Use snow chains on the end of the vehicle with the dissimilar spare tire
- Use more than one dissimilar spare tire at a time
- Use commercial car washing equipment
- Try to repair the dissimilar spare tire

Use of one of the dissimilar spare tires listed above at any one wheel location can lead to impairment of the following:

- Handling, stability and braking performance
- Comfort and noise
- Ground clearance and parking at curbs
- Winter weather driving capability
- Wet weather driving capability

3. **Full-size dissimilar spare without label on wheel**

When driving with the full-size dissimilar spare tire/wheel, **do not:**

- Exceed 70 mph (113 km/h)
- Use more than one dissimilar spare tire/wheel at a time
- Use commercial car washing equipment
- Use snow chains on the end of the vehicle with the dissimilar spare tire/wheel

Roadside Emergencies

The usage of a full-size dissimilar spare tire/wheel can lead to impairment of the following:

- Handling, stability and braking performance
- Comfort and noise
- Ground clearance and parking at curbs
- Winter weather driving capability
- Wet weather driving capability
- All-wheel driving capability (if applicable)
- Load leveling adjustment (if applicable)

When driving with the full-size dissimilar spare tire/wheel additional caution should be given to:

- Towing a trailer
- Driving vehicles equipped with a camper body
- Driving vehicles with a load on the cargo rack

Drive cautiously when using a full-size dissimilar spare tire/wheel and seek service as soon as possible.

Stopping and securing the vehicle

1. Park on a level surface, activate hazard flashers and set the parking brake.
2. Place the gearshift lever in P (Park) and turn the engine off.

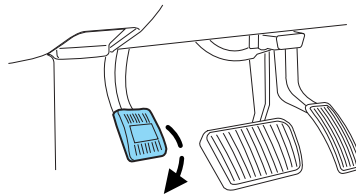

Roadside Emergencies

Removing the spare tire and jack

1. Lift the carpeted load floor panel located in the rear of the vehicle.
2. Remove the spare tire cover (if equipped).
3. Remove the wing nut securing the spare tire by turning it counterclockwise.
4. Remove the washer.
5. Lift and remove the temporary spare tire from the cargo area.
6. Remove the jack assembly from the vehicle. Loosen the bag tabs and remove the jack and lug wrench from the bag.
7. Fold down the wrench socket used to loosen the lug nuts and operate the jack.

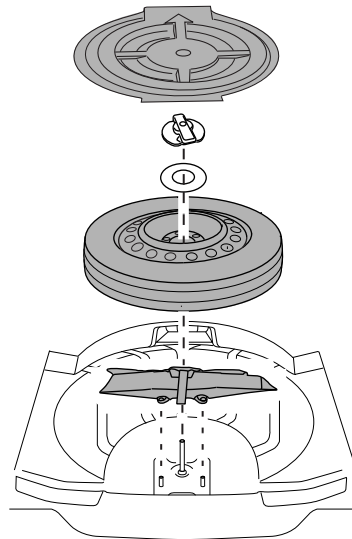

Tire change procedure



WARNING: When one of the front wheels is off the ground, the transmission alone will not prevent the vehicle from moving or slipping off the jack, even if the vehicle is in P (Park).



WARNING: To help prevent the vehicle from moving when you change a tire, be sure to place the transmission in P (Park), set the parking brake and block (in both directions) the wheel that is diagonally opposite (other side and end of the vehicle) to the tire being changed.



WARNING: If the vehicle slips off the jack, you or someone else could be seriously injured.

Roadside Emergencies

 **WARNING:** Do not attempt to change a tire on the side of the vehicle close to moving traffic. Pull far enough off the road to avoid the danger of being hit when operating the jack or changing the wheel.

Note: Passengers should not remain in the vehicle when the vehicle is being jacked.

1. Block the diagonally opposite wheel.

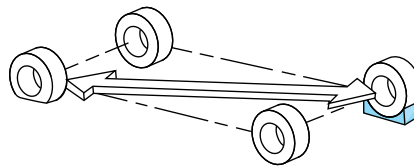

2. Loosen each wheel lug nut one-half turn counterclockwise but do not remove them until the wheel is raised off the ground.

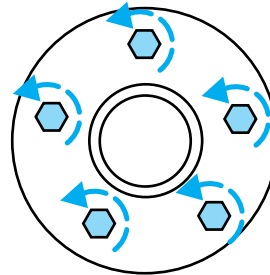

 **WARNING:** To lessen the risk of personal injury, do not put any part of your body under the vehicle while changing a tire. Do not start the engine when your vehicle is on the jack. The jack is only meant for changing the tire.

Roadside Emergencies

3. Align the slot on top of the jack with the sheet metal flange indicated by the jack locator triangle next to the tire you are changing. Turn the jack handle clockwise until the wheel is completely off the ground.

4. Remove the lug nuts with the lug wrench.

5. Replace the flat tire with the spare tire, making sure the valve stem is facing outward. Reinstall the lug nuts until the wheel is snug against the hub. Do not fully tighten the lug nuts until the wheel has been lowered.

6. Lower the wheel by turning the jack handle counterclockwise.

7. Remove the jack and fully tighten the lug nuts in the order shown. Refer to *Wheel lug nut torque specifications* later in this chapter for the proper lug nut torque specification.

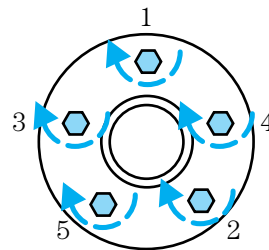
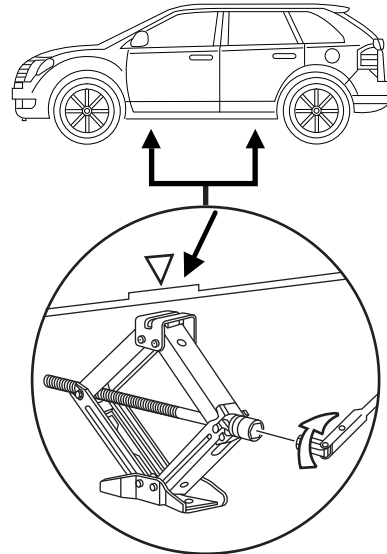

Stowing the flat/spare tire and jack

1. Fully collapse the jack, fold the wrench socket into the handle and place them both into the bag making sure to secure the tabs.
2. Place the jack assembly in the spare tire well aligning it with the two vertical studs.
3. Place the tire in the spare tire well over the jack assembly.

Roadside Emergencies

If you are stowing a flat 22 inch tire and wheel assembly, temporarily remove the load floor, plastic stowage bins (if equipped), and the foam load floor supports to make space for the 22 inch tire and wheel assembly. Place the 22 inch tire & wheel assembly in the spare tire well with the valve stem facing down. Rotate the tire until the jack assembly is able to protrude through a wheel opening. Replace the plastic stowage bins (if equipped) and foam load floor supports around the 22 inch tire and wheel assembly.

If you are stowing a flat tire, place the tire in the spare tire well with the valve stem facing down. Rotate the tire until the jack assembly is able to protrude through a wheel opening.

If you are stowing the spare tire, place the spare in the spare tire well in its original position.

4. Secure the wheel by replacing the washer and the wing nut and turning the wing nut clockwise.

WHEEL LUG NUT TORQUE SPECIFICATIONS

Retighten the lug nuts to the specified torque within 100 miles (160 km) after any wheel disturbance (rotation, flat tire, wheel removal, etc.).

| Lug nut socket size/Bolt size | Wheel lug nut torque* | |
|--|-----------------------|-----|
| | ft-lb | N•m |
| Lug nut socket size: $\frac{3}{4}$ inch (19 mm) hex Bolt size: $\frac{1}{2}$ x 20 | 100 | 135 |
| * Torque specifications are for nut and bolt threads free of dirt and rust. Use only Ford recommended replacement fasteners. | | |



WARNING: When a wheel is installed, always remove any corrosion, dirt or foreign materials present on the mounting surfaces of the wheel or the surface of the wheel hub, brake drum or brake disc that contacts the wheel. Ensure that any fasteners that attach the rotor to the hub are secured so they do not interfere with the mounting surfaces of the wheel. Installing wheels without correct metal-to-metal contact at the wheel mounting surfaces can cause the wheel nuts to loosen and the wheel to come off while the vehicle is in motion, resulting in loss of control.

Roadside Emergencies

Note: Inspect the wheel pilot hole prior to installation. If there is visible corrosion in wheel pilot hole, remove loose particles by wiping with clean rag and apply grease. Apply grease only to the wheel pilot hole surface by smearing a “dime” (1 square cm) sized glob of grease around the wheel pilot surface (1) with end of finger. **DO NOT** apply grease to lugnut/stud holes or wheel-to-brake surfaces.

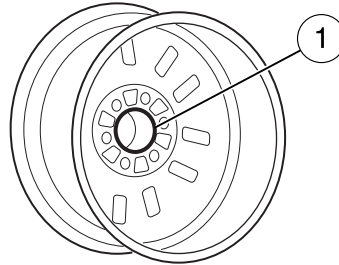

RUNNING OUT OF FUEL

If you have run out of fuel and need to refill the vehicle with a portable fuel container, see *Running out of fuel* in the *Maintenance and Specifications* chapter for proper fuel filling method using a portable fuel container and the included fuel filler funnel. **Do not** insert the nozzle of portable fuel containers or any type of aftermarket funnels into the Easy Fuel™ “no cap” fuel system as it can be damaged. You must use the included funnel in such circumstances.

WARNING: Do not insert the nozzle of portable fuel containers or aftermarket funnels into the Easy Fuel™ system. This could damage the fuel system and its seal, and may cause fuel to run onto the ground instead of filling the tank, all of which could result in serious personal injury.

JUMP STARTING

WARNING: The gases around the battery can explode if exposed to flames, sparks, or lit cigarettes. An explosion could result in injury or vehicle damage.

WARNING: Batteries contain sulfuric acid which can burn skin, eyes and clothing, if contacted.

Do not attempt to push-start your automatic transmission vehicle. Automatic transmissions do not have push-start capability. Attempting to push-start a vehicle with an automatic transmission may cause transmission damage.

272

Roadside Emergencies

Preparing your vehicle

When the battery is disconnected or a new battery is installed, the automatic transmission must relearn its shift strategy. As a result, the transmission may have firm and/or soft shifts. This operation is considered normal and will not affect function or durability of the transmission. Over time, the adaptive learning process will fully update transmission operation.

1. **Use only a 12-volt supply to start your vehicle.**
2. Do not disconnect the battery of the disabled vehicle as this could damage the vehicle's electrical system.
3. Park the booster vehicle close to the hood of the disabled vehicle making sure the two vehicles **do not** touch. Set the parking brake on both vehicles and stay clear of the engine cooling fan and other moving parts.
4. Check all battery terminals and remove any excessive corrosion before you attach the battery cables. Ensure that vent caps are tight and level.
5. Turn the heater fan on in both vehicles to protect from any electrical surges. Turn all other accessories off.

Connecting the jumper cables

Note: In the illustration, the vehicle on the bottom is used to designate the assisting (boosting) battery.

Roadside Emergencies

1. Connect the positive (+) jumper cable to the positive (+) terminal of the discharged battery.
2. Connect the other end of the positive (+) cable to the positive (+) terminal of the assisting battery.
3. Connect the negative (-) cable to the negative (-) terminal of the assisting battery.
4. Make the final connection of the negative (-) cable to an exposed metal part of the stalled vehicle's engine, away from the battery and the carburetor/fuel injection system.

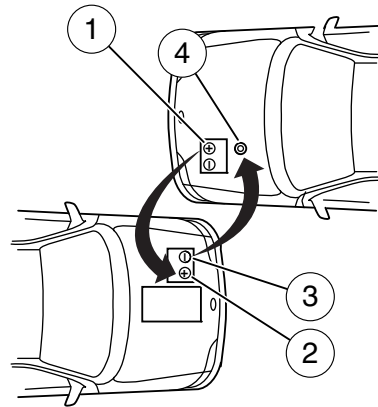

Note: Do not attach the negative (-) cable to fuel lines, engine rocker covers, the intake manifold or electrical components as grounding points.



WARNING: Do not connect the end of the second cable to the negative (-) terminal of the battery to be jumped. A spark may cause an explosion of the gases that surround the battery.

Ensure that the cables are clear of fan blades, belts, moving parts of both engines, or any fuel delivery system parts.

Jump starting

1. Start the engine of the booster vehicle and run the engine at moderately increased speed.
2. Start the engine of the disabled vehicle.
3. Once the disabled vehicle has been started, run both engines for an additional three minutes before disconnecting the jumper cables.

Roadside Emergencies

Removing the jumper cables

Remove the jumper cables in the reverse order that they were connected.

Note: In the illustration, the vehicle on the bottom is used to designate the assisting (boosting) battery.

1. Remove the jumper cable from the ground metal surface.
2. Remove the jumper cable on the negative (-) terminal of the booster vehicle's battery.
3. Remove the jumper cable from the positive (+) terminal of the booster vehicle's battery.
4. Remove the jumper cable from the positive (+) terminal of the disabled vehicle's battery.

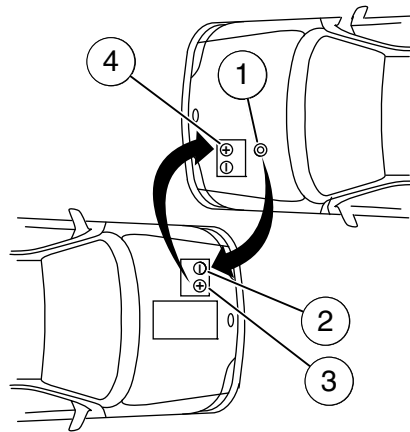

After the disabled vehicle has been started and the jumper cables removed, allow it to idle for several minutes so the engine computer can relearn its idle conditions.

Roadside Emergencies

WRECKER TOWING

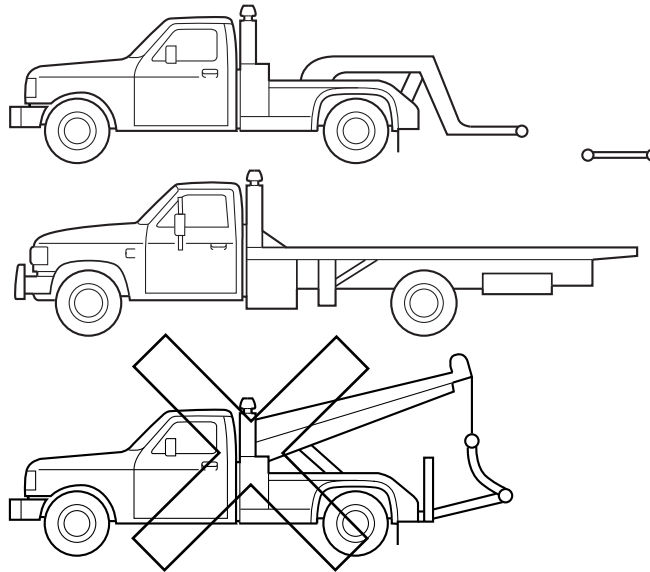

If you need to have your vehicle towed, contact a professional towing service or, if you are a member of a roadside assistance program, your roadside assistance service provider.

It is recommended that your vehicle be towed with a wheel lift and dollies or flatbed equipment. Do not tow with a slingbelt. Ford Motor Company has not approved a slingbelt towing procedure.

On FWD vehicles, if your vehicle is to be towed from the front, ensure proper wheel lift equipment is used to raise the front wheels off the ground. The rear wheels can be left on the ground when towed in this fashion.

If your vehicle is to be towed from the rear using wheel lift equipment, it is recommended that the front wheels (drive wheels) be placed on a dolly to prevent damage to the automatic transmission.

On AWD vehicles, it is **required** that your vehicle be towed with a wheel lift and dollies or flatbed equipment with all the wheels off the ground to prevent damage to the automatic transmission, AWD system or vehicle.

Roadside Emergencies

If the vehicle is towed by other means or incorrectly, vehicle damage may occur.

Ford Motor Company produces a towing manual for all authorized tow truck operators. Have your tow truck operator refer to this manual for proper hook-up and towing procedures for your vehicle.

Emergency towing

In case of a roadside emergency with a disabled vehicle (without access to wheel dollies, car hauling trailer, or flatbed transport vehicle) your vehicle (regardless of transmission powertrain configuration) can be flat towed (all wheels on the ground) under the following conditions:

- Vehicle is facing forward so that it is being towed in a forward direction.
- Place the transmission in N (Neutral). Refer to *Brake-shift interlock* in the *Driving* chapter for specific instructions if you cannot move the gear shift lever into N (Neutral).
- Maximum speed is not to exceed 35 mph (56 km/h).
- Maximum distance is 50 miles (80 km).

Customer Assistance

GETTING THE SERVICES YOU NEED

Warranty repairs to your vehicle must be performed by an authorized Ford, Lincoln, or Mercury dealer. While any authorized dealer handling your vehicle line will provide warranty service, we recommend you return to your selling authorized dealer who wants to ensure your continued satisfaction.

Please note that certain warranty repairs require special training and/or equipment, so not all authorized dealers are authorized to perform all warranty repairs. This means that, depending on the warranty repair needed, you may have to take your vehicle to another authorized dealer.

A reasonable time must be allowed to perform a repair after taking your vehicle to the authorized dealer. Repairs will be made using Ford or Motorcraft® parts, or remanufactured or other parts that are authorized by Ford.

Away from home

If you are away from home when your vehicle needs service, contact the Ford Customer Relationship Center or use the online resources listed below to find the nearest authorized dealer.

In the United States:

Mailing address

Ford Motor Company
Customer Relationship Center
P.O. Box 6248
Dearborn, MI 48121

Telephone

1-800-392-3673 (FORD)
(TDD for the hearing impaired: 1-800-232-5952)

Online

Additional information and resources are available online at www.genuineservice.com.

- U.S. dealer locator by Dealer Name, City/State, or Zip Code
- Owner Guides
- Maintenance Schedules
- Recalls
- Ford Extended Service Plans
- Ford Genuine Accessories
- Service specials and promotions.

278

Customer Assistance

In Canada:

Mailing address (Ford vehicles)

Customer Relationship Centre
Ford Motor Company of Canada, Limited
P.O. Box 2000
Oakville, Ontario L6J 5E4

Telephone

1-800-565-3673 (FORD)

Online

www.ford.ca

Mailing address (Lincoln vehicles)

Lincoln Centre
Ford Motor Company of Canada, Limited
P.O. Box 2000
Oakville, Ontario L6J 5E4

Telephone

1-800-387-9333

Online

www.lincolncanada.com

Additional assistance

If you have questions or concerns, or are unsatisfied with the service you are receiving, follow these steps:

1. Contact your Sales Representative or Service Advisor at your selling/servicing authorized dealer.
2. If your inquiry or concern remains unresolved, contact the Sales Manager, Service Manager or Customer Relations Manager.
3. If you require assistance or clarification on Ford Motor Company policies, please contact the Ford Customer Relationship Center

In order to help you serve you better, please have the following information available when contacting a Customer Relationship Center:

- Vehicle Identification Number (VIN)
- Your telephone number (home and business)
- The name of the authorized dealer and city where located
- The vehicle's current odometer reading

In some states, you must directly notify Ford in writing before pursuing remedies under your state's warranty laws. Ford is also allowed a final repair attempt in some states.

279

Customer Assistance

In the United States, a warranty dispute must be submitted to the BBB AUTO LINE before taking action under the Magnuson-Moss Warranty Act, or to the extent allowed by state law, before pursuing replacement or repurchase remedies provided by certain state laws. This dispute handling procedure is not required prior to enforcing state created rights or other rights which are independent of the Magnuson-Moss Warranty Act or state replacement or repurchase laws.

IN CALIFORNIA (U.S. ONLY)

California Civil Code Section 1793.2(d) requires that, if a manufacturer or its representative is unable to repair a motor vehicle to conform to the vehicle's applicable express warranty after a reasonable number of attempts, the manufacturer shall be required to either replace the vehicle with one substantially identical or repurchase the vehicle and reimburse the buyer in an amount equal to the actual price paid or payable by the consumer (less a reasonable allowance for consumer use). The consumer has the right to choose whether to receive a refund or replacement vehicle.

California Civil Code Section 1793.22(b) presumes that the manufacturer has had a reasonable number of attempts to conform the vehicle to its applicable express warranties if, within the first 18 months of ownership of a new vehicle or the first 18,000 miles (29,000 km), whichever occurs first:

1. Two or more repair attempts are made on the same non-conformity likely to cause death or serious bodily injury OR
2. Four or more repair attempts are made on the same nonconformity (a defect or condition that substantially impairs the use, value or safety of the vehicle) OR
3. The vehicle is out of service for repair of nonconformities for a total of more than 30 calendar days (not necessarily all at one time)

In the case of 1 or 2 above, the consumer must also notify the manufacturer of the need for the repair of the nonconformity at the following address:

Ford Motor Company
16800 Executive Plaza Drive
Mail Drop 3NE-B
Dearborn, MI 48126

You are required to submit your warranty dispute to BBB AUTO LINE before asserting in court any rights or remedies conferred by California Civil Code Section 1793.22(b). You are also required to use BBB AUTO 280

Customer Assistance

LINE before exercising rights or seeking remedies created by the Federal Magnuson-Moss Warranty Act, 15 U.S.C. sec. 2301 et seq. If you choose to seek redress by pursuing rights and remedies not created by California Civil Code Section 1793.22(b) or the Magnuson-Moss Warranty Act, resort to BBB AUTO LINE is not required by those statutes.

THE BETTER BUSINESS BUREAU (BBB) AUTO LINE PROGRAM (U.S. ONLY)

Your satisfaction is important to Ford Motor Company and to your dealer. If a warranty concern has not been resolved using the three-step procedure outlined on the first page of the *Customer Assistance* section, you may be eligible to participate in the BBB AUTO LINE program.

The BBB AUTO LINE program consists of two parts – mediation and arbitration. During mediation, a representative of the BBB will contact both you and Ford Motor Company to explore options for settlement of the claim. If an agreement is not reached during mediation or you do not want to participate in mediation, and if your claim is eligible, you may participate in the arbitration process. An arbitration hearing will be scheduled so that you can present your case in an informal setting before an impartial person. The arbitrator will consider the testimony provided and make a decision after the hearing.

Disputes submitted to the BBB AUTO LINE program are usually decided within forty days after you file your claim with the BBB. You are not bound by the decision, and may reject the decision and proceed to court where all findings of the BBB Auto Line dispute, and decision, are admissible in the court action. Should you choose to accept the BBB AUTO LINE decision, Ford is then bound by the decision, and must comply with the decision within 30 days of receipt of your acceptance letter.

BBB AUTO LINE Application: Using the information provided below, please call or write to request a program application. You will be asked for your name and address, general information about your new vehicle, information about your warranty concerns, and any steps you have already taken to try to resolve them. A Customer Claim Form will be mailed that will need to be completed, signed and returned to the BBB along with proof of ownership. Upon receipt, the BBB will review the claim for eligibility under the Program Summary Guidelines.

Customer Assistance

You can get more information by calling BBB AUTO LINE at 1-800-955-5100, or writing to:

**BBB AUTO LINE
4200 Wilson Boulevard, Suite 800
Arlington, Virginia 22203-1833**

BBB AUTO LINE applications can also be requested by calling the Ford Motor Company Customer Relationship Center at 1-800-392-3673.

Note: Ford Motor Company reserves the right to change eligibility limitations, modify procedures, or to discontinue this process at any time without notice and without obligation.

UTILIZING THE MEDIATION/ARBITRATION PROGRAM (CANADA ONLY)

For vehicles delivered to authorized Canadian dealers. In those cases where you continue to feel that the efforts by Ford of Canada and the authorized dealer to resolve a factory-related vehicle service concern have been unsatisfactory, Ford of Canada participates in an impartial third party mediation/arbitration program administered by the Canadian Motor Vehicle Arbitration Plan (CAMVAP).

The CAMVAP program is a straight forward and relatively speedy alternative to resolve a disagreement when all other efforts to produce a settlement have failed. This procedure is without cost to you and is designed to eliminate the need for lengthy and expensive legal proceedings.

In the CAMVAP program, impartial third-party arbitrators conduct hearings at mutually convenient times and places in an informal environment. These impartial arbitrators review the positions of the parties, make decisions and, when appropriate, render awards to resolve disputes. CAMVAP decisions are fast, fair, and final as the arbitrator's award is binding on both you and Ford of Canada.

CAMVAP services are available in all Canadian territories and provinces. For more information, without charge or obligation, call your CAMVAP Provincial Administrator directly at 1-800-207-0685 or visit www.camvap.ca.

GETTING ASSISTANCE OUTSIDE THE U.S. AND CANADA

Before exporting your vehicle to a foreign country, contact the appropriate foreign embassy or consulate. These officials can inform you of local vehicle registration regulations and where to find unleaded fuel.

If you cannot find unleaded fuel or can only get fuel with an anti-knock index lower than is recommended for your vehicle, contact a regional office or owner relations/customer relationship office.

282

Customer Assistance

The use of leaded fuel in your vehicle without proper conversion may damage the effectiveness of your emission control system and may cause engine knocking or serious engine damage. Ford Motor Company/Ford of Canada is not responsible for any damage caused by use of improper fuel. Using leaded fuel may also result in difficulty importing your vehicle back into the U.S.

If your vehicle must be serviced while you are traveling or living in Asia-Pacific Region, Sub-Saharan Africa, U.S. Virgin Islands, Central America, the Caribbean, and Israel, contact the nearest authorized dealer. If the authorized dealer cannot help you, contact:

FORD MOTOR COMPANY
FORD EXPORT OPERATIONS
1555 Fairlane Drive
Fairlane Business Park #3
Allen Park, Michigan 48101
U.S.A.
Telephone: (313) 594-4857
FAX: (313) 390-0804
Email: expcac@ford.com

If your vehicle must be serviced while you are traveling or living in Puerto Rico, contact the nearest authorized dealer. If the authorized dealer cannot help you, contact:

Ford International Business Development Inc.
Customer Assistance Center
P.O. Box 11957
Caparra Heights Station
San Juan, Puerto Rico 00922-1957
Telephone: (800) 841-FORD (3673)
FAX: (313) 390-0804
Email: prcac@ford.com

Customer Assistance

If your vehicle must be serviced while you are traveling or living in the Middle East, contact the nearest authorized dealer. If the authorized dealer cannot help you, contact:

Ford Middle East
Customer Relationship Center
P.O. Box 21470
Dubai, United Arab Emirates
Telephone: +971 4 3326084
FAX: +971 4 3327299
Email: menacac@ford.com
www.me.ford.com

If you buy your vehicle in North America and then relocate to any of the above locations, register your vehicle identification number (VIN) and new address with Ford Motor Company Export Operations.

If you are in another foreign country, contact the nearest authorized dealer. If the authorized dealer employees cannot help you, they can direct you to the nearest Ford affiliate office.

Customers in the U.S. should call 1-800-392-3673.

ORDERING ADDITIONAL OWNER'S LITERATURE

To order the publications in this portfolio, contact Helm, Incorporated at:

HELM, INCORPORATED
P.O. Box 07150
Detroit, Michigan 48207

Or to order a free publication catalog, call toll free: 1-800-782-4356

Monday-Friday 8:00 a.m. - 6:00 p.m. EST

Helm, Incorporated can also be reached by their website:
www.helminc.com.

(Items in this catalog may be purchased by credit card, check or money order.)

Obtaining a French Owner's Guide

French Owner's Guides can be obtained from your authorized dealer or by contacting Helm, Incorporated using the contact information listed previously in this section.

Customer Assistance

REPORTING SAFETY DEFECTS (U.S. ONLY)

If you believe that your vehicle has a defect which could cause a crash or could cause injury or death, you should immediately inform the National Highway Traffic Safety



Administration (NHTSA) in addition to notifying Ford Motor Company.

If NHTSA receives similar complaints, it may open an investigation, and if it finds that a safety defect exists in a group of vehicles, it may order a recall and remedy campaign. However, NHTSA cannot become involved in individual problems between you, your dealer, or Ford Motor Company.

To contact NHTSA, you may call the Vehicle Safety Hotline toll-free at 1-888-327-4236 (TTY: 1-800-424-9153); go to <http://www.safercar.gov>; or write to:

Administrator
1200 New Jersey Avenue, Southeast
Washington, D.C. 20590

You can also obtain other information about motor vehicle safety from <http://www.safercar.gov>.

REPORTING SAFETY DEFECTS (CANADA ONLY)

If you believe that your vehicle has a defect which could cause a crash or could cause injury or death, you should immediately inform Transport Canada, using their toll-free number: 1-800-333-0510, or online at: <https://wwwwapps.tc.gc.ca/Saf-Sec-Sur/7/PCDB-BDPP/Index.aspx>.

Cleaning

WASHING THE EXTERIOR

Wash your vehicle regularly with cool or lukewarm water and a neutral pH shampoo, such as Motorcraft® Detail Wash (ZC-3-A), which is available from your authorized dealer.

- Never use strong household detergents or soap, such as dish washing or laundry liquid. These products can discolor and spot painted surfaces.
- Never wash a vehicle that is “hot to the touch” or during exposure to strong, direct sunlight.
- Always use a clean sponge or car wash mitt with plenty of water for best results.
- Dry the vehicle with a chamois or soft terry cloth towel in order to eliminate water spotting.
- It is especially important to wash the vehicle regularly during the winter months, as dirt and road salt are difficult to remove and cause damage to the vehicle.
- Immediately remove items such as gasoline, diesel fuel, bird droppings and insect deposits because they can cause damage to the vehicle's paintwork and trim over time. Use Motorcraft® Bug and Tar Remover (ZC-42) which is available from your authorized dealer.
- Remove any exterior accessories, such as antennas, before entering a car wash.
- **Suntan lotions and insect repellents can damage any painted surface; if these substances come in contact with your vehicle, wash off as soon as possible.**

Exterior chrome

- Wash the vehicle first, using cool or lukewarm water and a neutral pH shampoo, such as Motorcraft® Detail Wash (ZC-3-A).
- Use Motorcraft® Custom Bright Metal Cleaner (ZC-15), available from your authorized dealer. Apply the product as you would a wax to clean bumpers and other chrome parts; allow the cleaner to dry for a few minutes, then wipe off the haze with a clean, dry rag.
- **Never use abrasive materials such as steel wool or plastic pads as they can scratch the chrome surface.**

WAXING

- Wash the vehicle first.
- Use a quality wax that does not contain abrasives.

286

Cleaning

- Do not allow paint sealant to come in contact with any non-body (low-gloss black) colored trim, such as grained door handles, roof racks, bumpers, side moldings, mirror housings or the windshield cowl area. The paint sealant will “gray” or stain the parts over time.

PAINT CHIPS

Your authorized dealer has touch-up paint to match your vehicle's color. Take your color code (printed on a sticker in the driver's door jamb) to your authorized dealer to ensure you get the correct color.

- Remove particles such as bird droppings, tree sap, insect deposits, tar spots, road salt and industrial fallout before repairing paint chips.
- Always read the instructions before using the products.

ALUMINUM WHEELS AND WHEEL COVERS

Aluminum wheels and wheel covers are coated with a clearcoat paint finish. In order to maintain their shine:

- Clean weekly with Motorcraft® Wheel and Tire Cleaner (ZC-37-A), which is available from your authorized dealer. Heavy dirt and brake dust accumulation may require agitation with a sponge. Rinse thoroughly with a strong stream of water.
- Never apply any cleaning chemical to hot or warm wheel rims or covers.
- Some automatic car washes may cause damage to the finish on your wheel rims or covers. Industrial-strength (heavy-duty) cleaners, or cleaning chemicals, in combination with brush agitation to remove brake dust and dirt, could wear away the clearcoat finish over time.
- Do not use hydrofluoric acid-based or high caustic-based wheel cleaners, steel wool, fuels or strong household detergent.
- To remove tar and grease, use Motorcraft® Bug and Tar Remover (ZC-42), available from your authorized dealer.

ENGINE

Engines are more efficient when they are clean because grease and dirt buildup keep the engine warmer than normal. When washing:

- Take care when using a power washer to clean the engine. The high-pressure fluid could penetrate the sealed parts and cause damage.
- Do not spray a hot engine with cold water to avoid cracking the engine block or other engine components.

287

Cleaning

- Spray Motorcraft Engine Shampoo and Degreaser (ZC-20) on all parts that require cleaning and pressure rinse clean. In Canada, use Motorcraft Engine Shampoo (CXC-66-A).
- Cover the highlighted areas to prevent water damage when cleaning the engine.

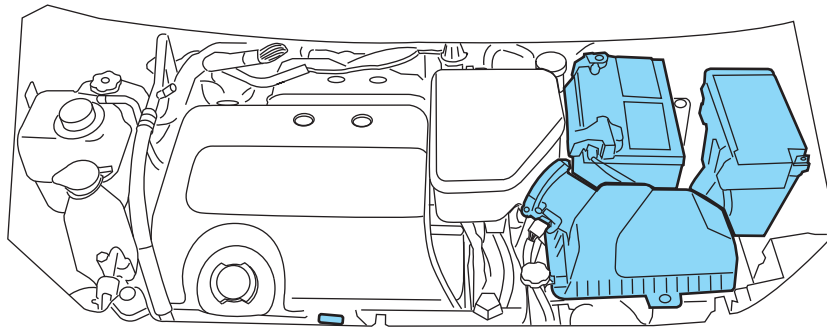

- Never wash or rinse the engine while it is hot or running; water in the running engine may cause internal damage.
- Never wash or rinse any ignition coil, spark plug wire or spark plug well, or the area in and around these locations.

PLASTIC (NON-PAINTED) EXTERIOR PARTS

Use only approved products to clean plastic parts. These products are available from your authorized dealer.

- For routine cleaning, use Motorcraft® Detail Wash (ZC-3-A).
- If tar or grease spots are present, use Motorcraft® Bug and Tar Remover (ZC-42).

WINDOWS AND WIPER BLADES

The windshield, rear and side windows and the wiper blades should be cleaned regularly. If the wipers do not wipe properly, substances on the vehicle's glass or the wiper blades may be the cause. These may include hot wax treatments used by commercial car washes, water repellent coatings, tree sap, or other organic contamination; these contaminants

288

Cleaning

may cause squeaking or chatter noise from the blades, and streaking and smearing of the windshield. To clean these items, follow these tips:

- The windshield, rear windows and side windows may be cleaned with a non-abrasive cleaner such as Motorcraft® Ultra-Clear Spray Glass Cleaner (ZC-23), available from your authorized dealer.
- The wiper blades can be cleaned with isopropyl (rubbing) alcohol or Motorcraft® Premium Windshield Washer Concentrate (ZC-32-A) in the U.S., or Premium Quality Windshield Washer Fluid [CXC-37-(A, B, D, or F)] in Canada, available from your authorized dealer. This washer fluid contains special solution in addition to alcohol which helps to remove the hot wax deposited on the wiper blade and windshield from automated car wash facilities. Be sure to replace wiper blades when they appear worn or do not function properly.
- Do not use abrasives, as they may cause scratches.
- Do not use fuel, kerosene, or paint thinner to clean any parts.

If you cannot remove those streaks after cleaning with the glass cleaner or if the wipers chatter and move in a jerky motion, clean the outer surface of the windshield and the wiper blades using a sponge or soft cloth with a neutral detergent or mild-abrasive cleaning solution. After cleaning, rinse the windshield and wiper blades with clean water. The windshield is clean if beads do not form when you rinse the windshield with water.

Do not use sharp objects, such as a razor blade, to clean the inside of the rear window or to remove decals, as it may cause damage to the rear window defroster's heated grid lines.

PANORAMIC ROOF DEFLECTOR (IF EQUIPPED)

Vacuum the wind deflector cloth to remove insects & loose dirt. Clean with Motorcraft Professional Strength Carpet & Upholstery Cleaner (ZC-54).

INSTRUMENT PANEL/INTERIOR TRIM AND CLUSTER LENS

Clean the instrument panel, interior trim areas and cluster lens with a clean, damp, white cotton cloth, then use a clean and dry white cotton cloth to dry these areas.

- Avoid cleaners or polishes that increase the gloss of the upper portion of the instrument panel. The dull finish in this area helps protect the driver from undesirable windshield reflection.

Cleaning

- Be certain to wash or wipe your hands clean if you have been in contact with certain products such as insect repellent and suntan lotion in order to avoid possible damage to the interior painted surfaces.
- Do not use household or glass cleaners as these may damage the finish of the instrument panel, interior trim and cluster lens.
- Do not allow air fresheners and hand sanitizers to spill on interior surfaces. If a spill occurs, **wipe off immediately**. Damage may not be covered by your warranty.



WARNING: Do not use chemical solvents or strong detergents when cleaning the steering wheel or instrument panel to avoid contamination of the airbag system.

If a staining liquid like coffee/juice has been spilled on the instrument panel or on interior trim surfaces, clean as follows:

1. Wipe up spilled liquid using a clean, white, cotton cloth.
2. Wipe the surface with a damp, clean, white cotton cloth. For more thorough cleaning, use a mild soap and water solution. If the spot cannot be completely cleaned by this method, the area may be cleaned using a commercially available cleaning product designed for automotive interiors.
3. If necessary, apply more soap and water solution or cleaning product to a clean, white, cotton cloth and press the cloth onto the soiled area—allow this to set at room temperature for 30 minutes.
4. Remove the soaked cloth, and if it is not soiled badly, use this cloth to clean the area by using a rubbing motion for 60 seconds.
5. Following this, wipe area dry with a clean, white, cotton cloth.

INTERIOR

For fabric, carpets, cloth seats and safety belts:

- Remove dust and loose dirt with a vacuum cleaner.
- Remove light stains and soil with Motorcraft® Professional Strength Carpet & Upholstery Cleaner (ZC-54).
- If grease or tar is present on the material, spot-clean the area first with Motorcraft® Spot and Stain Remover (ZC-14). In Canada, use Motorcraft® Multi-Purpose Cleaner (CXC-101).
- If a ring forms on the fabric after spot cleaning, clean the entire area immediately (but do not oversaturate) or the ring will set.

290

Cleaning

- Do not use household cleaning products or glass cleaners, which can stain and discolor the fabric and affect the flame retardant abilities of the seat materials.



WARNING: Do not use cleaning solvents, bleach or dye on the vehicle's seatbelts, as these actions may weaken the belt webbing.

LEATHER SEATS (IF EQUIPPED, EXCEPT FOR THE KING RANCH® EDITION)

For King Ranch® leather seats, refer to a separate section in this chapter.

- Clean spills and stains as quickly as possible.
- For routine cleaning, wipe the surface with a soft, damp cloth. For more thorough cleaning, wipe the surface with a mild soap and water solution. In Canada, use Motorcraft® Vinyl Cleaner (CXC-93). Dry the area with a soft cloth.
- If the leather cannot be completely cleaned using a mild soap and water solution, the leather may be cleaned using a commercially available leather cleaning product designed for automotive interiors.
- To check for compatibility, first test any cleaner or stain remover on an inconspicuous part of the leather.
- Do not use household cleaning products, alcohol solutions, solvents or cleaners intended for rubber, vinyl and plastics, or oil/petroleum-based leather conditioners. These products may cause premature wearing or damage to the leather.

LEATHER SEATS FOR THE KING RANCH® EDITION ONLY (IF EQUIPPED)

Your vehicle is equipped with seating covered in premium, top-grain leather which is extremely durable, but still requires special care and maintenance in order to ensure longevity and comfort.

Regular cleaning and conditioning will maintain the appearance of the leather.

Cleaning

For dirt, use a vacuum cleaner then use a clean, damp cloth or soft brush.

For routine cleaning, wipe the surface with a soft, damp cloth. For more thorough cleaning, wipe the surface with a mild soap and water solution.

291

Cleaning

- Clean spills as quickly as possible.
- Test any cleaner or stain remover on an inconspicuous part of the leather as cleaners may darken the leather.
- Do not spill coffee, ketchup, mustard, orange juice or oil-based products on the leather as they may permanently stain the leather.
- Do not use household cleaning products, alcohol solutions, solvents or cleaners intended for rubber, vinyl or plastics.

Scratches

Natural Markings - Because the leather in the seat comes from genuine steer hides, there will be evidence of naturally occurring markings, such as small scars. These markings give character to the seating covers and should be considered as proof of a genuine leather product.

In order to lessen the appearance of certain scratches and other wear marks, apply conditioner on the affected area following the same instructions as in the *Conditioning* section.

Conditioning

Bottles of King Ranch® Leather Conditioner are available at the King Ranch® Saddle Shop. Visit the website at www.krsaddleshop.com, or telephone (in the United States) 1-800-282-KING (5464). If you are unable to obtain King Ranch® Leather Conditioner, use another premium leather conditioner.

- Clean the surfaces using the steps outlined in the *Cleaning* section.
- Ensure the leather is dry then apply a nickel-sized amount of conditioner to a clean, dry cloth.
- Rub the conditioner into leather until it disappears. Allow the conditioner to dry and repeat the process for the entire interior. If a film appears, wipe off film with a dry, clean cloth.

UNDERBODY

Flush the complete underside of your vehicle frequently. Keep body and door drain holes free from packed dirt.

FORD AND LINCOLN MERCURY CAR CARE PRODUCTS

Your Ford or Lincoln Mercury authorized dealer has many quality products available to clean your vehicle and protect its finishes. These quality products have been specifically engineered to fulfill your automotive needs; they are custom designed to complement the style and appearance of your vehicle. Each product is made from high quality materials that meet or exceed rigid specifications. For best results, use the following products or products of equivalent quality:

- Motorcraft® Bug and Tar Remover (ZC-42)
- Motorcraft® Custom Bright Metal Cleaner (ZC-15)
- Motorcraft® Detail Wash (ZC-3-A)
- Motorcraft® Dusting Cloth (ZC-24)
- Motorcraft® Engine Shampoo and Degreaser (U.S. only) (ZC-20)
- Motorcraft® Engine Shampoo (Canada only) (CXC-66-A)
- Motorcraft® Multi-Purpose Cleaner (Canada only) (CXC-101)
- Motorcraft® Premium Glass Cleaner (Canada only) (CXC-100)
- Motorcraft® Premium Quality Windshield Washer Fluid (Canada only) [CXC-37-(A, B, D or F)]
- Motorcraft® Premium Windshield Washer Concentrate (U.S. only) (ZC-32-A)
- Motorcraft® Professional Strength Carpet & Upholstery Cleaner (ZC-54)
- Motorcraft® Spot and Stain Remover (U.S. only) (ZC-14)
- Motorcraft® Ultra-Clear Spray Glass Cleaner (ZC-23)
- Motorcraft® Vinyl Cleaner (Canada only) (CXC-93)
- Motorcraft® Wheel and Tire Cleaner (ZC-37-A)

Maintenance and Specifications

SERVICE RECOMMENDATIONS

To help you service your vehicle, we provide *scheduled maintenance information* which makes tracking routine service easy.

If your vehicle requires professional service, your authorized dealer can provide the necessary parts and service. Check your *Warranty Guide* to find out which parts and services are covered.

Use only recommended fuels, lubricants, fluids and service parts conforming to specifications. Motorcraft® parts are designed and built to provide the best performance in your vehicle.

PRECAUTIONS WHEN SERVICING YOUR VEHICLE

- Do not work on a hot engine.
- Make sure that nothing gets caught in moving parts.
- Do not work on a vehicle with the engine running in an enclosed space, unless you are sure you have enough ventilation.
- Keep all open flames and other burning material (such as cigarettes) away from the battery and all fuel related parts.

Working with the engine off

1. Set the parking brake and ensure the gearshift is securely latched in P (Park).
2. Turn off the engine.
3. Block the wheels to prevent the vehicle from moving unexpectedly.

Working with the engine on

1. Set the parking brake and shift to P (Park).
2. Block the wheels.



WARNING: To reduce the risk of vehicle damage and/or personal burn injuries, do not start your engine with the air cleaner removed and do not remove it while the engine is running.

Maintenance and Specifications

OPENING THE HOOD

1. Inside the vehicle, pull the hood release handle located under the bottom of the instrument panel near the steering column.

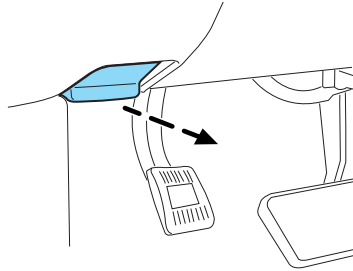

2. Go to the front of the vehicle and release the secondary hood latch that is located under the front center of the hood.

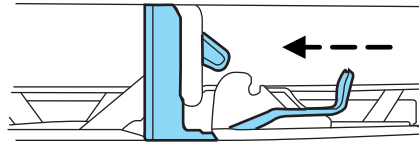

3. Lift the hood and support it with the prop rod.

Maintenance and Specifications

IDENTIFYING COMPONENTS IN THE ENGINE COMPARTMENT

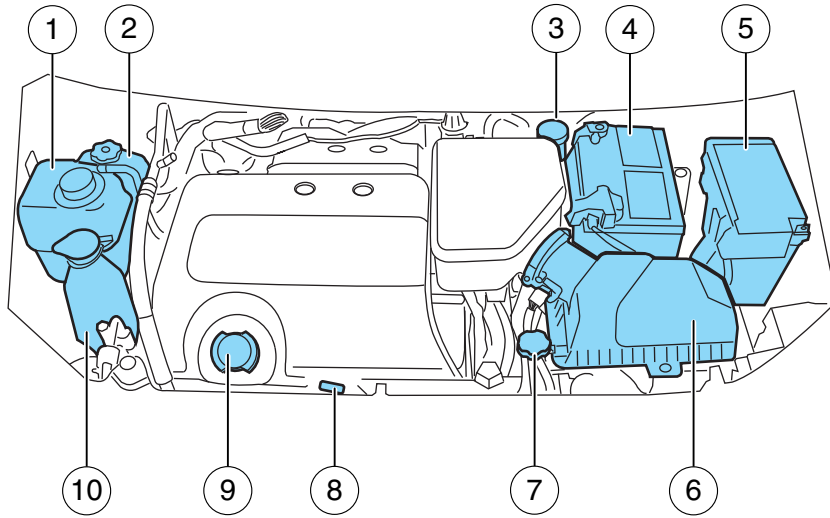

1. Engine coolant reservoir
2. Power steering fluid reservoir
3. Brake fluid reservoir
4. Battery
5. Power distribution box
6. Air filter assembly
7. Transmission fluid dipstick
8. Engine oil dipstick
9. Engine oil filler cap
10. Windshield washer fluid reservoir

Maintenance and Specifications

WINDSHIELD WASHER FLUID

Add fluid to fill the reservoir if the level is low. In very cold weather, do not fill the reservoir completely.

Only use a washer fluid that meets Ford specifications. Do not use any special washer fluid such as windshield water repellent type fluid or bug wash. They may cause squeaking, chatter noise, streaking and smearing. Refer to *Maintenance product specifications and capacities* in this chapter.



State or local regulations on volatile organic compounds may restrict the use of methanol, a common windshield washer antifreeze additive. Washer fluids containing non-methanol antifreeze agents should be used only if they provide cold weather protection without damaging the vehicle's paint finish, wiper blades or washer system.



WARNING: If you operate your vehicle in temperatures below 40°F (5°C), use washer fluid with antifreeze protection. Failure to use washer fluid with antifreeze protection in cold weather could result in impaired windshield vision and increase the risk of injury or accident.

CHANGING THE WIPER BLADES

1. Pull the wiper arm away from the vehicle. Turn the blade at an angle from the wiper arm. Press the lock tab to release the blade and pull the wiper blade down toward the windshield to remove it from the arm.

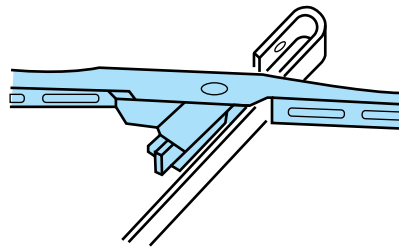

2. Attach the new wiper to the wiper arm and press it into place until a click is heard.

Replace wiper blades at least once per year for optimum performance.

Poor wiper quality can be improved by cleaning the wiper blades and the windshield. Refer to *Windows and wiper blades* in the *Cleaning* chapter.

Maintenance and Specifications

To prolong the life of the wiper blades, it is highly recommended to scrape off the ice on the windshield before turning on the wipers. The layer of ice has many sharp edges and can damage the micro edge of the wiper rubber element.

Changing rear window wiper blade

The rear wiper arm is designed without a service position. This reduces the risk of damage to the blade in an automatic car wash.

To replace the wiper blade:

1. Grab the wiper arm with one hand close to the arm/blade joint and pull it as far away from the glass as possible. Do not use excessive force because it can break the wiper arm at the heel. Hold it there until the next step.
2. Grab the primary structure of the blade with the other hand close to the arm/blade joint.
3. Grip tightly and press on the arm/blade joint from beneath and separate the blade from the arm.
4. Attach the new wiper to the wiper arm and press it into place until a click is heard.

If you find this procedure too difficult, please see your dealer.

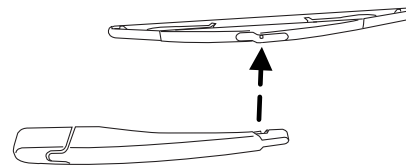
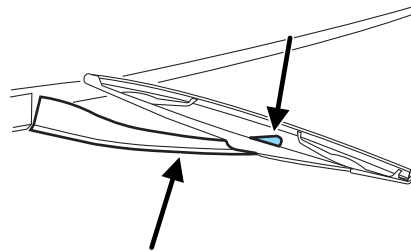

ENGINE OIL

Checking the engine oil

Refer to the *scheduled maintenance information* for the appropriate intervals for checking the engine oil.

1. Make sure the vehicle is on level ground.
2. Turn the engine off and wait 15 minutes for the oil to drain into the oil pan.
3. Set the parking brake and ensure the gearshift is securely latched in P (Park).

298

Maintenance and Specifications

4. Open the hood. Protect yourself from engine heat.
5. Locate and carefully remove the engine oil level dipstick.
6. Wipe the dipstick clean. Insert the dipstick fully, then remove it again.

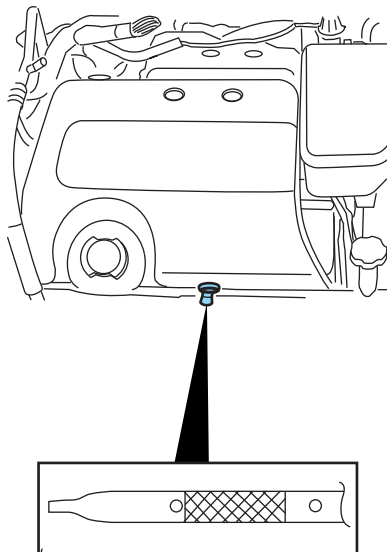

- If the oil level is **within this range**, the oil level is acceptable. **DO NOT ADD OIL.**

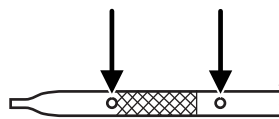

- If the oil level is **below this mark**, engine oil must be added to raise the level within the normal operating range.

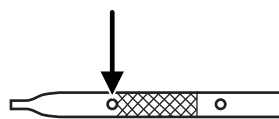

Maintenance and Specifications

- If required, add engine oil to the engine. Refer to *Adding engine oil* in this chapter.
- **Do not overfill the engine with oil. Oil levels above this mark may cause engine damage.** If the engine is overfilled, some oil must be removed from the engine by an authorized dealer.

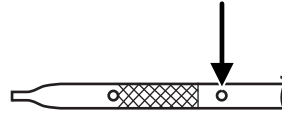

7. Put the dipstick back in and ensure it is fully seated.

Adding engine oil

1. Check the engine oil. For instructions, refer to *Checking the engine oil* in this chapter.
2. If the engine oil level is not within the normal operating range, add only certified engine oil of the recommended viscosity. Remove the engine oil filler cap and use a funnel to pour the engine oil into the opening.
3. Recheck the engine oil level. Make sure the oil level is not above the normal operating range on the engine oil level dipstick.
4. Install the dipstick and ensure it is fully seated.
5. Fully install the engine oil filler cap by turning the filler cap clockwise until it stops.

To avoid possible oil loss, DO NOT operate the vehicle with the engine oil level dipstick and/or the engine oil filler cap removed.

Engine oil and filter recommendations

Look for this certification trademark.

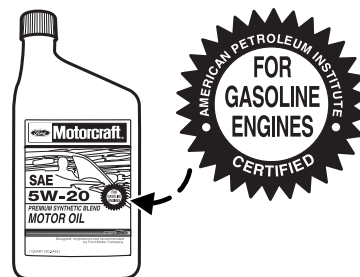

Maintenance and Specifications

Use SAE 5W-20 engine oil

Only use oils certified for gasoline engines by the American Petroleum Institute (API). An oil with this trademark symbol conforms to the current engine and emission system protection standards and fuel economy requirements of the International Lubricant Standardization and Approval Committee (ILSAC), comprised of U.S. and Japanese automobile manufacturers.

To protect your engine and engine's warranty, use Motorcraft® SAE 5W-20 or an equivalent SAE 5W-20 oil meeting Ford specification WSS-M2C930-A. **SAE 5W-20 oil provides optimum fuel economy and durability performance meeting all requirements for your vehicle's engine.** Refer to *Maintenance product specifications and capacities* later in this chapter for more information.

Do not use supplemental engine oil additives, cleaners or other engine treatments. They are unnecessary and could lead to engine damage that is not covered by Ford warranty.

Change your engine oil and filter according to the appropriate schedule listed in the *scheduled maintenance information*.

Ford production and Motorcraft® replacement oil filters are designed for added engine protection and long life. If a replacement oil filter is used that does not meet Ford material and design specifications, start-up engine noises or knock may be experienced.

It is recommended you use the appropriate Motorcraft® oil filter or another with equivalent performance for your engine application.

BATTERY

Your vehicle is equipped with a Motorcraft® maintenance-free battery which normally does not require additional water during its life of service.

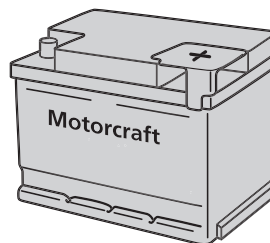

Maintenance and Specifications

If your battery has a cover/shield, make sure it is reinstalled after the battery has been cleaned or replaced.

For longer, trouble-free operation, keep the top of the battery clean and dry. Also, make certain the battery cables are always tightly fastened to the battery terminals.

If you see any corrosion on the battery or terminals, remove the cables from the terminals and clean with a wire brush. You can neutralize the acid with a solution of baking soda and water.

It is recommended that the negative battery cable terminal be disconnected from the battery if you plan to store your vehicle for an extended period of time. This will minimize the discharge of your battery during storage.

Note: Electrical or electronic accessories or components added to the vehicle by the dealer or the owner may adversely affect battery performance and durability.

 **WARNING:** Batteries normally produce explosive gases which can cause personal injury. Therefore, do not allow flames, sparks or lighted substances to come near the battery. When working near the battery, always shield your face and protect your eyes. Always provide proper ventilation.

 **WARNING:** When lifting a plastic-cased battery, excessive pressure on the end walls could cause acid to flow through the vent caps, resulting in personal injury and/or damage to the vehicle or battery. Lift the battery with a battery carrier or with your hands on opposite corners.

 **WARNING:** Keep batteries out of reach of children. Batteries contain sulfuric acid. Avoid contact with skin, eyes or clothing. Shield your eyes when working near the battery to protect against possible splashing of acid solution. In case of acid contact with skin or eyes, flush immediately with water for a minimum of 15 minutes and get prompt medical attention. If acid is swallowed, call a physician immediately.

 **WARNING:** Battery posts, terminals and related accessories contain lead and lead compounds. **Wash hands after handling.**

Maintenance and Specifications

Because your vehicle's engine is electronically controlled by a computer, some control conditions are maintained by power from the battery. When the battery is disconnected or a new battery is installed, the engine must relearn its idle and fuel trim strategy for optimum driveability and performance. To begin this process:

1. With the vehicle at a complete stop, set the parking brake.
 2. Put the gearshift in P (Park), turn off all accessories and start the engine.
 3. Run the engine until it reaches normal operating temperature.
 4. Allow the engine to idle for at least one minute.
 5. Turn the A/C on and allow the engine to idle for at least one minute.
 6. Release the parking brake. With your foot on the brake pedal and with the A/C on, put the vehicle in D (Drive) and allow the engine to idle for at least one minute.
 7. Drive the vehicle to complete the relearning process.
- The vehicle may need to be driven 10 miles (16 km) or more to relearn the idle and fuel trim strategy.
 - **If you do not allow the engine to relearn its idle trim, the idle quality of your vehicle may be adversely affected until the idle trim is eventually relearned.**

If the battery has been disconnected or a new battery has been installed, the clock and radio settings must be reset once the battery is reconnected.

- Always dispose of automotive batteries in a responsible manner. Follow your local authorized standards for disposal. Call your local authorized recycling center to find out more about recycling automotive batteries.

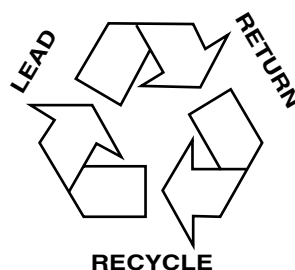

Maintenance and Specifications

ENGINE COOLANT

Checking engine coolant

The concentration and level of engine coolant should be checked at the intervals listed in *scheduled maintenance information*. The coolant concentration should be maintained at 50/50 coolant and distilled water, which equates to a freeze point of -34°F (-36°C). Coolant concentration testing is possible with a hydrometer or antifreeze tester. The level of coolant should be maintained at the FULL COLD level or within the COLD FILL RANGE in the coolant reservoir. If the level falls below, add coolant per the instructions in the *Adding engine coolant* section.

Your vehicle was factory-filled with a 50/50 engine coolant and water concentration. If the concentration of coolant falls below 40% or above 60%, the engine parts could become damaged or not work properly. **A 50/50 mixture of coolant and water provides the following:**

- **Freeze protection down to -34°F (-36°C).**
- **Boiling protection up to 265°F (129°C).**
- **Protection against rust and other forms of corrosion.**
- **Proper function of calibrated gauges.**

When the engine is cold, check the level of the engine coolant in the reservoir.

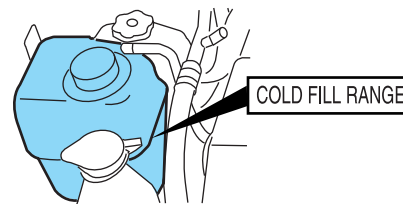

- The engine coolant should be at the FULL COLD level, or within the COLD FILL or MIN / MAX range as listed on the engine coolant reservoir (depending upon application).
- Refer to *scheduled maintenance information* for service interval schedules.

If the engine coolant has not been checked at the recommended interval, the engine coolant reservoir may become low or empty. If the reservoir is low or empty, add engine coolant to the reservoir. Refer to *Adding engine coolant* in this chapter.

Note: Automotive fluids are not interchangeable; do not use engine coolant/antifreeze or windshield washer fluid outside of its specified function and vehicle location.

304

Maintenance and Specifications

Adding engine coolant

When adding coolant, make sure it is a 50/50 mixture of engine coolant and distilled water. Add the mixture to the coolant reservoir, **when the engine is cool**, until the appropriate fill level is obtained. If coolant is filled to the COLD FILL RANGE or FULL COLD level when the engine is not cool, the system will remain underfilled.



WARNING: Do not add engine coolant when the engine is hot. Steam and scalding liquids released from a hot cooling system can burn you badly. Also, you can be burned if you spill coolant on hot engine parts.



WARNING: Do not put engine coolant in the windshield washer fluid container. If sprayed on the windshield, engine coolant could make it difficult to see through the windshield.

- **DO NOT MIX** different colors or types of coolant in your vehicle. Make sure the correct coolant is used. **DO NOT MIX** recycled coolant and new (unused) coolant together in the vehicle. Mixing of engine coolants may harm your engine's cooling system. The use of an improper coolant may harm engine and cooling system components and may void the warranty. Refer to *Maintenance product specifications and capacities* in this chapter.
- A large amount of water without engine coolant may be added, in case of emergency, to reach a vehicle service location. In this instance, the cooling system must be drained and refilled with a 50/50 mixture of engine coolant and distilled water as soon as possible. Water alone (without engine coolant) can cause engine damage from corrosion, overheating or freezing.
- **Do not use alcohol, methanol, brine or any engine coolants mixed with alcohol or methanol antifreeze (coolant).** Alcohol and other liquids can cause engine damage from overheating or freezing.
- **Do not add extra inhibitors or additives to the coolant.** These can be harmful and compromise the corrosion protection of the engine coolant.

For vehicles with overflow coolant systems with a non-pressurized cap on the coolant recovery system, add coolant to the coolant recovery reservoir when the engine is cool. Add the proper mixture of coolant and distilled water to the FULL COLD level. For all other vehicles which have

305

Maintenance and Specifications

a coolant degas system with a pressurized cap, or if it is necessary to remove the coolant pressure relief cap on the radiator of a vehicle with an overflow system, follow these steps to add engine coolant.



WARNING: To reduce the risk of personal injury, make sure the engine is cool before unscrewing the coolant pressure relief cap. The cooling system is under pressure; steam and hot liquid can come out forcefully when the cap is loosened slightly.

Add the proper mixture of coolant and water to the cooling system by following these steps:

1. Before you begin, turn the engine off and let it cool.
2. When the engine is cool, wrap a thick cloth around the coolant pressure relief cap on the coolant reservoir (a translucent plastic bottle). Slowly turn cap counterclockwise (left) until pressure begins to release.
3. Step back while the pressure releases.
4. When you are sure that all the pressure has been released, use the cloth to turn it counterclockwise and remove the cap.
5. Fill the coolant reservoir slowly with the proper coolant mixture, to within the COLD FILL RANGE or the FULL COLD level on the reservoir. If you removed the radiator cap in an overflow system, fill the radiator until the coolant is visible and radiator is almost full.
6. Replace the cap. Turn until tightly installed. Cap must be tightly installed to prevent coolant loss.

After any coolant has been added, check the coolant concentration (refer to *Checking engine coolant*). If the concentration is not 50/50 (protection to $-34^{\circ}\text{F}/-36^{\circ}\text{C}$), drain some coolant and adjust the concentration. It may take several drains and additions to obtain a 50/50 coolant concentration.

Whenever coolant has been added, the coolant level in the coolant reservoir should be checked the next few times you drive the vehicle. If necessary, add enough 50/50 concentration of engine coolant and distilled water to bring the liquid level to the proper level.

If you have to add more than 1.0 quart (1.0 liter) of engine coolant per month, have your authorized dealer check the engine cooling system. Your cooling system may have a leak. Operating an engine with a low level of coolant can result in engine overheating and possible engine damage.

306

Maintenance and Specifications

Recycled engine coolant

Ford Motor Company does NOT recommend the use of recycled engine coolant since a Ford-approved recycling process is not yet available.



Used engine coolant should be disposed of in an appropriate manner. Follow your community's regulations and standards for recycling and disposing of automotive fluids.

Coolant refill capacity

To find out how much fluid your vehicle's cooling system can hold, refer to *Maintenance product specifications and capacities* in this chapter.

Fill your engine coolant reservoir as outlined in *Adding engine coolant* in this section.

Severe climates

If you drive in extremely cold climates (less than -34°F [-36°C]):

- **It may be necessary to increase the coolant concentration above 50%.**
- **NEVER increase the coolant concentration above 60%.**
- **A coolant concentration of 60% will provide freeze point protection down to -62°F [-52°C]. Increased engine coolant concentrations above 60% will decrease the overheat protection characteristics of the engine coolant and may cause engine damage.**
- **If available, refer to the chart on the coolant container to ensure the coolant concentration in your vehicle will provide adequate freeze protection at the temperatures in which you drive in the winter months.**

If you drive in extremely hot climates:

- **It is still necessary to maintain the coolant concentration above 40%.**
- **NEVER decrease the coolant concentration below 40%.**
- **A coolant concentration of 40% will provide freeze point protection down to -12°F [-24°C]. Decreased engine coolant concentrations below 40% will decrease the corrosion/freeze protection characteristics of the engine coolant and may cause engine damage.**
- **If available, refer to the chart on the coolant container to ensure the coolant concentration in your vehicle will provide adequate protection at the temperatures in which you drive.**

307

Maintenance and Specifications

Vehicles driven year-round in non-extreme climates should use a 50/50 mixture of engine coolant and distilled water for optimum cooling system and engine protection.

What you should know about fail-safe cooling

If the engine coolant supply is depleted, this feature allows the vehicle to be driven temporarily before incremental component damage is incurred. The “fail-safe” distance depends on ambient temperatures, vehicle load and terrain.

How fail-safe cooling works

If the engine begins to overheat:

- The engine coolant temperature gauge will move to the red (hot) area.
- The service engine soon  symbol will illuminate.

If the engine reaches a preset over-temperature condition, the engine will automatically switch to alternating cylinder operation. Each disabled cylinder acts as an air pump and cools the engine.

When this occurs the vehicle will still operate. However:

- The engine power will be limited.
- The air conditioning system will be disabled.

Continued operation will increase the engine temperature:

- The engine will completely shut down.
- Steering and braking effort will increase.

Once the engine temperature cools, the engine can be re-started. Take your vehicle to an authorized dealer as soon as possible to minimize engine damage.

When fail-safe mode is activated

You have limited engine power when in the fail-safe mode, so drive the vehicle with caution. The vehicle will not be able to maintain high speed operation and the engine will run rough. Remember that the engine is capable of completely shutting down automatically to prevent engine damage, therefore:

1. Pull off the road as soon as safely possible and turn off the engine.
2. Arrange for the vehicle to be taken to an authorized dealer.
3. If this is not possible, wait a short period for the engine to cool.

308

Maintenance and Specifications

4. Check the coolant level and replenish if low.



WARNING: Fail-safe mode is for use during emergencies only. Operate the vehicle in fail-safe mode only as long as necessary to bring the vehicle to rest in a safe location and seek immediate repairs. When in fail-safe mode, the vehicle will have limited power, will not be able to maintain high-speed operation, and may completely shut down without warning, potentially losing engine power, power steering assist, and power brake assist, which may increase the possibility of a crash resulting in serious injury.



WARNING: Never remove the coolant reservoir cap while the engine is running or hot.

5. Restart the engine and take your vehicle to an authorized dealer.

Driving the vehicle without repairing the engine problem increases the chance of engine damage. Take your vehicle to an authorized dealer as soon as possible.

FUEL FILTER

Your vehicle is equipped with a lifetime fuel filter that is integrated with the fuel tank. Regular maintenance or replacement is not needed.

WHAT YOU SHOULD KNOW ABOUT AUTOMOTIVE FUELS

Important safety precautions



WARNING: Do not overfill the fuel tank. The pressure in an overfilled tank may cause leakage and lead to fuel spray and fire.



WARNING: The fuel system may be under pressure. If you hear a hissing sound near the fuel filler door (Easy Fuel™ “no cap” fuel system), do not refuel until the sound stops. Otherwise, fuel may spray out, which could cause serious personal injury.



WARNING: Automotive fuels can cause serious injury or death if misused or mishandled.

Maintenance and Specifications



WARNING: Gasoline may contain benzene, which is a cancer-causing agent.

Observe the following guidelines when handling automotive fuel:

- Extinguish all smoking materials and any open flames before refueling your vehicle.
- Always turn off the vehicle before refueling.
- Automotive fuels can be harmful or fatal if swallowed. Fuel such as gasoline is highly toxic and if swallowed can cause death or permanent injury. If fuel is swallowed, call a physician immediately, even if no symptoms are immediately apparent. The toxic effects of fuel may not be visible for hours.
- Avoid inhaling fuel vapors. Inhaling too much fuel vapor of any kind can lead to eye and respiratory tract irritation. In severe cases, excessive or prolonged breathing of fuel vapor can cause serious illness and permanent injury.
- Avoid getting fuel liquid in your eyes. If fuel is splashed in the eyes, remove contact lenses (if worn), flush with water for 15 minutes and seek medical attention. Failure to seek proper medical attention could lead to permanent injury.
- Fuels can also be harmful if absorbed through the skin. If fuel is splashed on the skin and/or clothing, promptly remove contaminated clothing and wash skin thoroughly with soap and water. Repeated or prolonged skin contact with fuel liquid or vapor causes skin irritation.
- Be particularly careful if you are taking “Antabuse” or other forms of disulfiram for the treatment of alcoholism. Breathing gasoline vapors, or skin contact could cause an adverse reaction. In sensitive individuals, serious personal injury or sickness may result. If fuel is splashed on the skin, promptly wash skin thoroughly with soap and water. Consult a physician immediately if you experience an adverse reaction.



WARNING: When refueling always shut the engine off and never allow sparks or open flames near the filler neck. Never smoke while refueling. Fuel vapor is extremely hazardous under certain conditions. Care should be taken to avoid inhaling excess fumes.

Maintenance and Specifications



WARNING: The flow of fuel through a fuel pump nozzle can produce static electricity, which can cause a fire if fuel is pumped into an ungrounded fuel container.

Refueling



WARNING: Fuel vapor burns violently and a fuel fire can cause severe injuries. To help avoid injuries to you and others:

- Read and follow all the instructions on the pump island;
- Turn off your engine when you are refueling;
- Do not smoke if you are near fuel or refueling your vehicle;
- Keep sparks, flames and smoking materials away from fuel;
- Stay outside your vehicle and do not leave the fuel pump unattended when refueling your vehicle — this is against the law in some places;
- Keep children away from the fuel pump; never let children pump fuel.
- Do not use personal electronic devices while refueling. It can ignite fuel vapors.

Use the following guidelines to avoid electrostatic charge build-up when filling an ungrounded fuel container:

- Place approved fuel container on the ground.
- DO NOT fill a fuel container while it is in the vehicle (including the cargo area).
- Keep the fuel pump nozzle in contact with the fuel container while filling.
- DO NOT use a device that would hold the fuel pump handle in the fill position.

Easy Fuel™ “no cap” fuel system

Your fuel tank is equipped with an Easy Fuel™ “no cap” fuel filler system. This allows you to simply open the fuel filler door and insert the fuel filler nozzle into the fuel system. The Easy Fuel™ system is self-sealing and protected against dust, dirt, water and snow/ice.

When fueling your vehicle:

1. Turn the engine off.

Maintenance and Specifications

2. Open the fuel filler door.
3. Slowly insert the fuel filler nozzle fully into the fuel system and leave the nozzle fully inserted until you are done pumping. Pump fuel as normal.
4. After you are done pumping fuel, wait about five seconds before slowly removing the fuel filler nozzle. This allows residual fuel to drain back into the fuel tank and not spill onto the vehicle.

Note: A fuel spillage concern may occur if overfilling the fuel tank. Do not overfill the tank to the point that the fuel is able to bypass the fuel filler nozzle. The overfilled fuel may run down the drain located within the fuel filler housing and to the ground.

If the check fuel fill inlet light or CHECK FUEL FILL INLET message comes on, the fuel fill inlet may not have properly closed. The inlet may have stuck open or debris may be preventing the inlet from fully closing. At the next opportunity, safely pull off the road, turn off the engine, open the fuel filler door and remove any visible debris from the fuel fill opening. Insert either the fuel fill nozzle or the fuel fill funnel (see *Refilling with a portable fuel container* for funnel location) provided with the vehicle several times to dislodge any debris and/or allow the inlet to close properly. If this action corrects the problem, the check fuel fill inlet light or CHECK FUEL FILL INLET message may not reset immediately. It may take several driving cycles for the check fuel fill inlet light or CHECK FUEL FILL INLET message to turn off. A driving cycle consists of an engine start-up (after four or more hours with the engine off) followed by city/highway driving. Continuing to drive with the check fuel fill inlet light or CHECK FUEL FILL INLET message on may cause the service engine soon lamp to turn on as well.



WARNING: The fuel system may be under pressure. If you hear a hissing sound near the fuel filler door (Easy Fuel™ “no cap” fuel system), do not refuel until the sound stops. Otherwise, fuel may spray out, which could cause serious personal injury.

Choosing the right fuel

Use only UNLEADED fuel or UNLEADED fuel blended with a maximum of 10% ethanol. Do not use fuel ethanol (E85), diesel, methanol, leaded fuel or any other fuel. The use of leaded fuel is prohibited by law and could damage your vehicle.

Your vehicle was not designed to use fuel or fuel additives with metallic compounds, including manganese-based additives.

312

Maintenance and Specifications

Note: Use of any fuel other than those recommended may cause powertrain damage, a loss of vehicle performance, and repairs may not be covered under warranty.

Octane recommendations

Your vehicle is designed to use “Regular” unleaded gasoline with a pump (R+M)/2 octane rating of 87. Some stations offer fuels posted as “Regular” with an octane rating below 87, particularly in high altitude areas. Fuels with octane levels below 87 are not recommended.

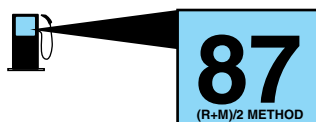

Do not be concerned if your engine sometimes knocks lightly. However, if it knocks heavily under most driving conditions while you are using fuel with the recommended octane rating, see your authorized dealer to prevent any engine damage.

Fuel quality

If you are experiencing starting, rough idle or hesitation driveability problems during a cold start, try a different brand of “Regular” unleaded gasoline. Premium unleaded gasoline is not recommended for vehicles designed to use “Regular” unleaded gasoline because it may cause these problems to become more pronounced. If the problems persist, see your authorized dealer.

Do not add aftermarket fuel additive products to your fuel tank. It should not be necessary to add any aftermarket products to your fuel tank if you continue to use high quality fuel of the recommended octane rating. These products have not been approved for your engine and could cause damage to the fuel system. Repairs to correct the effects of using an aftermarket product in your fuel may not be covered by your warranty.

Many of the world’s automakers approved the World-Wide Fuel Charter that recommends gasoline specifications to provide improved performance and emission control system protection for your vehicle. Gasolines that meet the World-Wide Fuel Charter should be used when available. Ask your fuel supplier about gasolines that meet the World-Wide Fuel Charter.

Cleaner air

Ford endorses the use of reformulated “cleaner-burning” gasolines to improve air quality, per the recommendations in the *Choosing the right fuel* section.

313

Maintenance and Specifications

Running out of fuel

Avoid running out of fuel because this situation may have an adverse effect on powertrain components.

If you have run out of fuel:

- You may need to cycle the ignition from off to on several times after refueling to allow the fuel system to pump the fuel from the tank to the engine. On restarting, cranking time will take a few seconds longer than normal. With keyless ignition, just start the engine. Crank time will be longer than usual.
- Normally, adding 1 gallon (3.8L) of fuel is enough to restart the engine. If the vehicle is out of fuel and on a steep grade, more than 1 gallon (3.8L) may be required.
- The service engine soon  indicator may come on. For more information on the service engine soon indicator, refer to *Warning lights and chimes* in the *Instrument Cluster* chapter.

Refilling with a portable fuel container

With the Easy Fuel™ “no cap” fuel system, use the following directions when filling from a portable fuel container:



WARNING: Do not insert the nozzle of portable fuel containers or aftermarket funnels into the Easy Fuel™ system. This could damage the fuel system and its seal, and may cause fuel to run onto the ground instead of filling the tank, which could result in serious personal injury.



WARNING: Do not try to pry open or push open the Easy Fuel™ system with foreign objects. This could damage the fuel system and its seal and cause injury to you or others.

When filling the vehicle's fuel tank from a portable fuel container, use the funnel included with the vehicle.

Maintenance and Specifications

1. After lifting the trunk cargo cover, locate the white plastic funnel. It is attached to the rear, lower edge of the spare tire compartment.

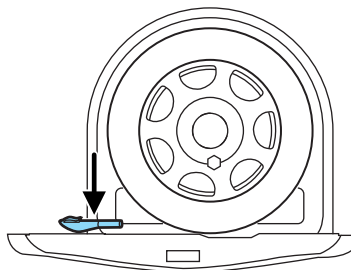

2. Slowly insert the funnel into the Easy Fuel™ system.

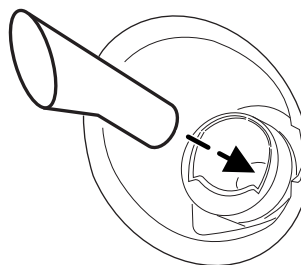

3. Fill the vehicle with fuel from the portable fuel container.

4. When done, clean the funnel or properly dispose of it. Extra funnels can be purchased from your authorized dealer if you choose to dispose of the funnel. **Do not** use aftermarket funnels; they will not work with the Easy Fuel™ system and can damage it. The included funnel has been specially designed to work safely with your vehicle.

ESSENTIALS OF GOOD FUEL ECONOMY

Measuring techniques

Your best source of information about actual fuel economy is you, the driver. You must gather information as accurately and consistently as possible. Fuel expense, frequency of fill-ups or fuel gauge readings are NOT accurate as a measure of fuel economy. We do not recommend taking fuel economy measurements during the first 1,000 miles (1,600 km) of driving (engine break-in period). You will get a more accurate measurement after 2,000 miles–3,000 miles (3,000 km–5,000 km).

Maintenance and Specifications

Filling the tank

The advertised fuel capacity of the fuel tank on your vehicle is equal to the rated refill capacity of the fuel tank as listed in the *Maintenance product specifications and capacities* section of this chapter.

The advertised capacity is the amount of the indicated capacity and the empty reserve combined. Indicated capacity is the difference in the amount of fuel in a full tank and a tank when the fuel gauge indicates empty. Empty reserve is the small amount of fuel remaining in the fuel tank after the fuel gauge indicates empty.

The amount of usable fuel in the empty reserve varies and should not be relied upon to increase driving range. When refueling your vehicle after the fuel gauge indicates empty, you might not be able to refuel the full amount of the advertised capacity of the fuel tank due to the empty reserve still present in the tank.

For consistent results when filling the fuel tank:

- Turn the engine/ignition switch to the off position prior to refueling, an error in the reading will result if the engine is left running.
- Use the same filling rate setting (low — medium — high) each time the tank is filled.
- Allow no more than two automatic click-offs when filling.
- Always use fuel with the recommended octane rating.
- Use a known quality gasoline, preferably a national brand.
- Have the vehicle loading and distribution the same every time.

Your results will be most accurate if your filling method is consistent.

Calculating fuel economy

1. Fill the fuel tank completely and record the initial odometer reading (in miles or kilometers).
2. Each time you fill the tank, record the amount of fuel added (in gallons or liters).
3. After at least three to five tank fill-ups, fill the fuel tank and record the current odometer reading.
4. Subtract your initial odometer reading from the current odometer reading.
5. Follow one of the simple calculations in order to determine fuel economy:

Calculation 1: **Divide total miles traveled by total gallons used.**

316

Maintenance and Specifications

Calculation 2: **Multiply liters used by 100, then divide by total kilometers traveled.**

Keep a record for at least one month and record the type of driving (city or highway). This will provide an accurate estimate of the vehicle's fuel economy under current driving conditions. Additionally, keeping records during summer and winter will show how temperature impacts fuel economy. In general, lower temperatures give lower fuel economy.

Driving style — good driving and fuel economy habits

Give consideration to the lists that follow and you may be able to change a number of variables and improve your fuel economy.

Habits

- Smooth, moderate operation can yield up to 10% savings in fuel.
- Steady speeds without stopping will usually give the best fuel economy.
- Idling for long periods of time (greater than one minute) may waste fuel.
- Anticipate stopping; slowing down may eliminate the need to stop.
- Sudden or hard accelerations may reduce fuel economy.
- Slow down gradually.
- Driving at reasonable speeds (traveling at 55 mph [88 km/h] uses 15% less fuel than traveling at 65 mph [105 km/h]).
- Revving the engine before turning it off may reduce fuel economy.
- Using the air conditioner or defroster may reduce fuel economy.
- You may want to turn off the speed control in hilly terrain if unnecessary shifting between the top gears occurs. Unnecessary shifting of this type could result in reduced fuel economy.
- Warming up a vehicle on cold mornings is not required and may reduce fuel economy.
- Resting your foot on the brake pedal while driving may reduce fuel economy.
- Combine errands and minimize stop-and-go driving.

Maintenance

- Keep tires properly inflated and use only recommended size.
- Operating a vehicle with the wheels out of alignment will reduce fuel economy.

Maintenance and Specifications

- Use recommended engine oil. Refer to *Maintenance product specifications and capacities* in this chapter.
- Perform all regularly scheduled maintenance items. Follow the recommended maintenance schedule and owner maintenance checks found in *scheduled maintenance information*.

Conditions

- Heavily loading a vehicle may reduce fuel economy at any speed.
- Carrying unnecessary weight may reduce fuel economy (approximately 1 mpg [0.4 km/L] is lost for every 400 lb [180 kg] of weight carried).
- Adding certain accessories to your vehicle (for example; bug deflectors, rollbars/light bars, running boards, ski/luggage racks) may reduce fuel economy.
- Using fuel blended with alcohol may lower fuel economy.
- Fuel economy may decrease with lower temperatures during the first 8–10 miles (12–16 km) of driving.
- Driving on flat terrain offers improved fuel economy as compared to driving on hilly terrain.
- Transmissions give their best fuel economy when operated in the top cruise gear and with steady pressure on the gas pedal.
- Close windows for high speed driving.

EMISSION CONTROL SYSTEM

Your vehicle is equipped with various emission control components and a catalytic converter which will enable your vehicle to comply with applicable exhaust emission standards. To make sure that the catalytic converter and other emission control components continue to work properly:

- Use only the specified fuel listed.
- Avoid running out of fuel.
- Do not turn off the ignition while your vehicle is moving, especially at high speeds.
- Have the items listed in *scheduled maintenance information* performed according to the specified schedule.

The scheduled maintenance items listed in *scheduled maintenance information* are essential to the life and performance of your vehicle and to its emissions system.

318

Maintenance and Specifications

If other than Ford, Motorcraft® or Ford-authorized parts are used for maintenance replacements or for service of components affecting emission control, such non-Ford parts should be equivalent to genuine Ford Motor Company parts in performance and durability.



WARNING: Do not park, idle, or drive your vehicle in dry grass or other dry ground cover. The emission system heats up the engine compartment and exhaust system, which can start a fire.

Illumination of the service engine soon  indicator, charging system warning light or the temperature warning light, fluid leaks, strange odors, smoke or loss of engine power could indicate that the emission control system is not working properly.

An improperly operating or damaged exhaust system may allow exhaust to enter the vehicle. Have a damaged or improperly operating exhaust system inspected and repaired immediately.





WARNING: Exhaust leaks may result in entry of harmful and potentially lethal fumes into the passenger compartment.

Do not make any unauthorized changes to your vehicle or engine. By law, vehicle owners and anyone who manufactures, repairs, services, sells, leases, trades vehicles, or supervises a fleet of vehicles are not permitted to intentionally remove an emission control device or prevent it from working. Information about your vehicle's emission system is on the Vehicle Emission Control Information Decal located on or near the engine. This decal also lists engine displacement.

Please consult your *Warranty Guide* for complete emission warranty information.

On-board diagnostics (OBD-II)

Your vehicle is equipped with a computer that monitors the engine's emission control system. This system is commonly known as the on-board diagnostics system (OBD-II). The OBD-II system protects the environment by ensuring that your vehicle continues to meet government emission standards. The OBD-II system also assists your authorized dealer in properly servicing your vehicle. When the service engine soon  indicator illuminates, the OBD-II system has detected a malfunction. Temporary malfunctions may cause the service engine soon  indicator to illuminate. Examples are:



1. The vehicle has run out of fuel—the engine may misfire or run poorly.

319

Maintenance and Specifications

2. Poor fuel quality or water in the fuel—the engine may misfire or run poorly.
3. The fuel fill inlet may not have been properly closed. See *Easy Fuel™ “no cap” fuel system* in this chapter.
4. Driving through deep water—the electrical system may be wet.



These temporary malfunctions can be corrected by filling the fuel tank with good quality fuel, properly closing the fuel fill inlet or letting the electrical system dry out. After three driving cycles without these or any other temporary malfunctions present, the service engine soon  indicator should stay off the next time the engine is started. A driving cycle consists of a cold engine startup followed by mixed city/highway driving. No additional vehicle service is required.

If the service engine soon  indicator remains on, have your vehicle serviced at the first available opportunity. Although some malfunctions detected by the OBD-II may not have symptoms that are apparent, continued driving with the service engine soon  indicator on can result in increased emissions, lower fuel economy, reduced engine and transmission smoothness, and lead to more costly repairs.

Readiness for Inspection/Maintenance (I/M) testing

Some state/provincial and local governments may have Inspection/Maintenance (I/M) programs to inspect the emission control equipment on your vehicle. Failure to pass this inspection could prevent you from getting a vehicle registration. Your vehicle may not pass the I/M test if the service engine soon  indicator is on or not working properly (bulb is burned out), or if the OBD-II system has determined that some of the emission control systems have not been properly checked. In this case, the vehicle is considered not ready for I/M testing.

If the service engine soon  indicator is on or the bulb does not work, the vehicle may need to be serviced. Refer to *On-board diagnostics (OBD-II)* in this chapter.

If the vehicle's engine or transmission has just been serviced, or the battery has recently run down or been replaced, the OBD-II system may indicate that the vehicle is not ready for I/M testing. To determine if the vehicle is ready for I/M testing, turn the ignition key to the on position for 15 seconds without cranking the engine. If the service engine soon  indicator blinks eight times, it means that the vehicle is not ready for I/M testing; if the service engine soon  indicator stays on solid, it means that the vehicle is ready for I/M testing.

320

Maintenance and Specifications

The OBD-II system is designed to check the emission control system during normal driving. A complete check may take several days. If the vehicle is not ready for I/M testing, the following driving cycle consisting of mixed city and highway driving may be performed:

15 minutes of steady driving on an expressway/highway followed by 20 minutes of stop-and-go driving with at least four 30-second idle periods.

Allow the vehicle to sit for at least eight hours without starting the engine. Then, start the engine and complete the above driving cycle. The engine must warm up to its normal operating temperature. Once started, do not turn off the engine until the above driving cycle is complete. If the vehicle is still not ready for I/M testing, the above driving cycle will have to be repeated.

POWER STEERING FLUID

Check the power steering fluid. Refer to *scheduled maintenance information*.

1. Start the engine and let it run until it reaches normal operating temperature (the engine coolant temperature gauge indicator will be near the center of the normal area between H and C).

2. While the engine idles, turn the steering wheel left and right several times.

3. Turn the engine off.

4. Check the fluid level in the reservoir. It should be between the MIN and MAX lines. Do not add fluid if the level is in this range.

5. If the fluid is low, add fluid in small amounts, continuously checking the level until it reaches the range between the MIN and MAX lines. Be sure to put the cap back on the reservoir. Refer to *Maintenance product specifications and capacities* in this chapter for the proper fluid type.

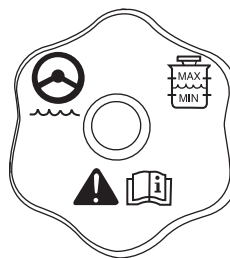

Maintenance and Specifications

BRAKE FLUID

The fluid level will drop slowly as the brakes wear, and will rise when the brake components are replaced. Fluid levels between the MIN and MAX lines are within the normal operating range; there is no need to add fluid. If the fluid levels are outside of the normal operating range, the performance of the system could be compromised; seek service from your authorized dealer immediately.

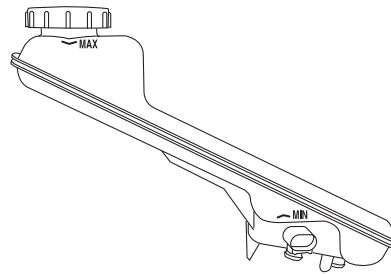

TRANSMISSION FLUID

Checking automatic transmission fluid

Refer to your *scheduled maintenance information* for scheduled intervals for fluid checks and changes. Your transmission does not consume fluid. However, the fluid level should be checked if the transmission is not working properly, i.e., if the transmission slips or shifts slowly or if you notice some sign of fluid leakage.

Automatic transmission fluid expands when warmed. To obtain an accurate fluid check, drive the vehicle until it is warmed up (approximately 20 miles [30 km]). If your vehicle has been operated for an extended period at high speeds, in city traffic during hot weather or pulling a trailer, the vehicle should be turned off until normal operating temperatures are reached to allow the fluid to cool before checking. Depending on vehicle use, cooling times could take up to 30 minutes or longer.



WARNING: The dipstick cap and surrounding components may be hot; gloves are recommended.

1. Drive the vehicle 20 miles (30 km) or until it reaches normal operating temperature.
2. Park the vehicle on a level surface and engage the parking brake.
3. With the parking brake engaged and your foot on the brake pedal, start the engine and move the gearshift lever through all of the gear ranges. Allow a minimum of 10 seconds for each gear to engage.
4. Latch the gearshift lever in P (Park) and leave the engine running.

322

Maintenance and Specifications

5. Remove the dipstick, wiping it clean with a clean, dry lint free rag. If necessary, refer to *Identifying components in the engine compartment* in this chapter for the location of the dipstick.

6. Install the dipstick making sure it is fully seated in the filler tube by turning it to the locked position.

7. Remove the dipstick and inspect the fluid level. The fluid should be in the designated areas for normal operating temperature.

Low fluid level

If the fluid level is below the MIN range of the dipstick, add fluid to reach the hash mark level. **Note:** If the fluid level is below the MIN

level, do not drive the vehicle. An underfill condition may cause shift and/or engagement concerns and/or possible damage.

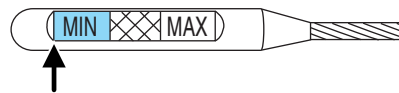

Correct fluid level

The transmission fluid should be checked at normal operating temperature 180°F-200°F (82°C-93°C) on a level surface. The normal operating temperature can be reached after approximately 20 miles (30 km) of driving.

The transmission fluid level should be targeted within the cross-hatch area if at normal operating temperature 180°F-200°F (82°C-93°C).

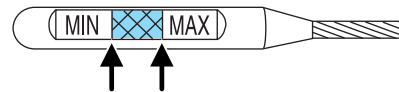

High fluid level

If the fluid level is above the MAX range of the dipstick, remove fluid to reach the hashmark level. **Note:** Fluid level above the MAX level may cause shift and/or engagement concerns and/or possible damage.

High fluid levels can be caused by an overheating condition. If your vehicle has been operated for an extended period at high speeds, in city traffic during hot weather or pulling a trailer, the vehicle should be turned off until normal operating temperatures are reached. Depending on vehicle use, cooling times could take up to 30 minutes or longer.

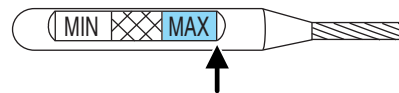

Adjusting automatic transmission fluid levels

Before adding any fluid, make sure the correct type is used. The type of fluid used is normally indicated on the dipstick and also in the *Maintenance product specifications and capacities* section in this chapter.

Maintenance and Specifications

Use of a non-approved automatic transmission fluid may cause internal transmission component damage.

If necessary, add fluid in 1/2 pint (250 ml) increments through the filler tube until the level is correct.

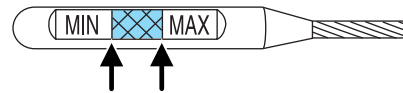

If an overfill occurs, excess fluid should be removed by an authorized dealer.

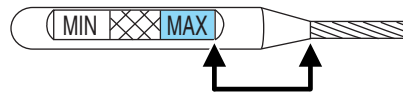

An overfill condition of transmission fluid may cause shift and/or engagement concerns and/or possible damage.

Do not use supplemental transmission fluid additives, treatments or cleaning agents. The use of these materials may affect transmission operation and result in damage to internal transmission components.

AIR FILTER

Refer to *scheduled maintenance information* for the appropriate intervals for changing the air filter element.

When changing the air filter element, use only the air filter element listed. Refer to *Motorcraft® part numbers* in this chapter.



WARNING: To reduce the risk of vehicle damage and/or personal burn injuries do not start your engine with the air cleaner removed and do not remove it while the engine is running.

Changing the air filter element

1. Release the clamps that secure the air filter housing cover.
2. Carefully separate the two halves of the air filter housing.
3. Remove the air filter element from the air filter housing.
4. Wipe the air filter housing and cover clean to remove any dirt or debris and to ensure good sealing.
5. Install a new air filter element. Be careful not to crimp the filter element edges between the air filter

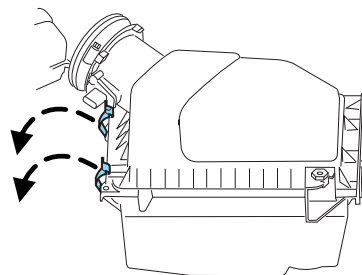

Maintenance and Specifications

housing and cover. This could cause filter damage and allow unfiltered air to enter the engine if not properly seated.

6. Replace the air filter housing cover and secure the clamps. Be sure that the air cleaner cover tabs are engaged into the slots of the air cleaner housing.

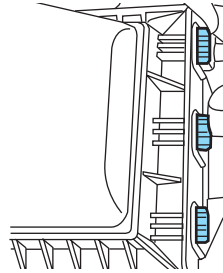

Note: Failure to use the correct air filter element may result in severe engine damage. The customer warranty may be void for any damage to the engine if the correct air filter element is not used.

VEHICLE STORAGE

If you plan on storing your vehicle for an extended period of time (30 days or more), refer to the following maintenance recommendations to ensure your vehicle stays in good operating condition.

All motor vehicles and their components were engineered and tested for reliable, regular driving. Long term storage under various conditions may lead to component degradation or failure unless specific precautions are taken to preserve the components.

General

- Store all vehicles in a dry, ventilated place.
- Protect from sunlight, if possible.
- If vehicles are stored outside, they require regular maintenance to protect against rust and damage.

Body

- Wash vehicle thoroughly to remove dirt, grease, oil, tar or mud from exterior surfaces, rear-wheel housing and underside of front fenders. See the *Cleaning* chapter for more information.
- Periodically wash vehicles stored in exposed locations.
- Touch-up raw or primed metal to prevent rust.
- Cover chrome and stainless steel parts with a thick coat of auto wax to prevent discoloration. Re-wax as necessary when the vehicle is washed. See the *Cleaning* chapter for more information.

325

Maintenance and Specifications

- Lubricate all hood, door and trunk lid hinges, and latches with a light grade oil. See the *Cleaning* chapter for more information.
- Cover interior trim to prevent fading.
- Keep all rubber parts free from oil and solvents.

Engine

- The engine oil and filter should be changed prior to storage, as used engine oil contain contaminants that may cause engine damage.
- Start the engine every 15 days. Run at fast idle until it reaches normal operating temperature.
- With your foot on the brake, shift through all the gears while the engine is running.

Fuel system

- Fill the fuel tank with high-quality fuel until the first automatic shutoff of the fuel pump nozzle.

Note: During extended periods of vehicle storage (30 days or more), fuel may deteriorate due to oxidation. Add Motorcraft® Gas Stabilizer or equivalent meeting Ford material specification ESE-M99C112-A to the vehicle fuel system whenever actual or expected storage periods exceed 30 days. Follow the instructions on the additive label. The vehicle should then be operated at idle speed to circulate the additive throughout the fuel system.

Cooling system

- Protect against freezing temperatures.
- When removing vehicle from storage, check coolant fluid level. Confirm there are no cooling system leaks, and fluid is at the recommended level.

Battery

- Check and recharge as necessary. Keep connections clean.
- If storing your vehicle for more than 30 days without recharging the battery, it may be advisable to disconnect the battery cables to ensure battery charge is maintained for quick starting.

Note: If battery cables are disconnected, it will be necessary to reset memory features.

Brakes

- Make sure brakes and parking brake are fully released.

326

Maintenance and Specifications

Tires

- Maintain recommended air pressure.

Miscellaneous

- Make sure all linkages, cables, levers and pins under vehicle are covered with grease to prevent rust.
- Move vehicles at least 25 feet (8 m) every 15 days to lubricate working parts and prevent corrosion.

Removing vehicle from storage

When your vehicle is ready to come out of storage, do the following:

- Wash your vehicle to remove any dirt or grease film build-up on window surfaces.
- Check windshield wipers for any deterioration.
- Check under the hood for any foreign material that may have collected during storage (mice/squirrel nests).
- Check the exhaust for any foreign material that may have collected during storage.
- Check tire pressures and set tire inflation per the Tire Label.
- Check brake pedal operation. Drive the vehicle 15 ft (4.5 meters) back and forth to remove rust build up.
- Check fluid levels (including coolant, oil and gas) to make sure there are no leaks, and fluids are at recommended levels.
- If the battery was removed, clean the battery cable ends and inspect.

If you have any concerns or issues, contact your authorized dealer.

Maintenance and Specifications

MOTORCRAFT PART NUMBERS

| Component | 3.7L V6 engine |
|---------------------------|---------------------|
| Engine air filter element | FA-1884 |
| Battery | BXT-65 |
| Oil filter | FL-500-S |
| Spark plugs | SP-520 ¹ |

¹ Refer to *scheduled maintenance information* for the appropriate intervals for changing the spark plugs.

Replace the spark plugs with ones that meet Ford material and design specifications for your vehicle, such as Motorcraft® or equivalent replacement parts. The customer warranty may be void for any damage to the engine if such spark plugs are not used.

Maintenance and Specifications

MAINTENANCE PRODUCT SPECIFICATIONS AND CAPACITIES

| Item | Capacity | Ford Part Name | Ford Part Number / Ford Specification |
|---|----------------------------------|--|--|
| Brake fluid | Between MIN and MAX on reservoir | Motorcraft® High Performance DOT 3 Motor Vehicle Brake Fluid | PM-1-C / WSS-M6C62-A or WSS-M6C65-A1 |
| Door weatherstrips | — | Silicone Spray Lubricant | XL-6 / ESR-M13P4-A |
| Door latch, hood latch, auxiliary hood latch, door hinges, striker plates, seat tracks and fuel filler door hinge | — | Multi-Purpose Grease (Lithium grease) | XG-4 or XL-5 or equivalent / ESB-M1C93-B |
| Lock cylinders | — | Motorcraft® Penetrating and Lock Lubricant | XL-1 / None |

Maintenance and Specifications

| Item | Capacity | Ford Part Name | Ford Part Number / Ford Specification |
|-------------------------------|------------------------------------|---|---|
| Engine oil ¹ | 5.5 quarts (5.2L) | <ul style="list-style-type: none"> Motorcraft® SAE 5W-20 Premium Synthetic Blend Motor Oil (US) Motorcraft® SAE 5W-20 Full Synthetic Motor Oil (US) Motorcraft® SAE 5W-20 Super Premium Motor Oil (Canada) Motorcraft® SAE 5W-20 Synthetic Motor Oil (Canada) | <ul style="list-style-type: none"> XO-5W20-QSP (US) XO-5W20-QFS (US) CXO-5W20-LSP12 (Canada) CXO-5W20-LFS12 (Canada) / WSS-M2C930-A with API Certification Mark |
| Engine coolant | 11.7 quarts (11.1L) ^{6,7} | Motorcraft® Specialty Green Engine Coolant (dark green-colored) ² | VC-10-A2 (US) CVC-10-A (Canada) / WSS-M97B55-A |
| Power steering fluid | Between MIN and MAX on reservoir | Motorcraft® MERCON® V ATF | XT-5-QM / MERCON® V |
| Automatic transmission fluid | 11.1 quarts (10.5L) ³ | Motorcraft® MERCON® LV ATF ⁴ | XT-10-QLV / MERCON® LV |
| Rear differential (AWD) fluid | 2.4 pints (1.15L) | Motorcraft® SAE 80W-90 Premium Rear Axle Lubricant | XY-80W90-QL / WSP-M2C197-A |

330

Maintenance and Specifications

| Item | Capacity | Ford Part Name | Ford Part Number / Ford Specification |
|--|----------------------|---|--|
| Power Transfer Unit (PTU) fluid (AWD) ⁵ | 12 ounces (0.35L) | Motorcraft® SAE 75W-140 Synthetic Rear Axle Lubricant | XY-75W140-QL / WSL-M2C192-A |
| Windshield washer fluid | Fill as required | Motorcraft® Premium Windshield Washer Concentrate (US) Premium Quality Windshield Washer Fluid (Canada) | ZC-32-A (US) CXC-37-(A, B, D, and F) (Canada) / WSB-M8B16-A2/- - |
| Fuel tank (front-wheel drive) | 19.2 gallons (72.7L) | — | — |
| Fuel tank (all-wheel drive) | 20.8 gallons (78.7L) | — | — |

¹Use of synthetic or synthetic blend motor oil is not mandatory. Engine oil need only meet the requirements of Ford specification WSS-M2C930-A and the API Certification mark.

²Add the coolant type originally equipped in your vehicle.

³Indicates only approximate dry-fill capacity. Some applications may vary based on cooler size and if equipped with an in-tank cooler. The amount of transmission fluid and fluid level should be set by the indication on the dipstick's normal operating range.

⁴Automatic transmissions that require MERCON® LV should only use MERCON® LV fluid. Refer to *scheduled maintenance information* to determine the correct service interval. Use of any fluid other than the recommended fluid may cause transmission damage.

⁵See your authorized dealer for fluid level checking or filling.

⁶Indicates only approximate dry fill capacity. Some applications may vary.

⁷Engine coolant with trailer tow package - 11.9 quarts (11.3L)

Maintenance and Specifications

ENGINE DATA

| Engine | 3.7L V6 engine |
|-------------------|---------------------------------|
| Cubic inches | 226 |
| Required fuel | 87 octane |
| Firing order | 1-4-2-5-3-6 |
| Ignition system | Coil on plug |
| Compression ratio | 10.3:1 |
| Spark plug gap | 0.049-0.053 inch (1.25-1.35 mm) |

Engine drivebelt routing

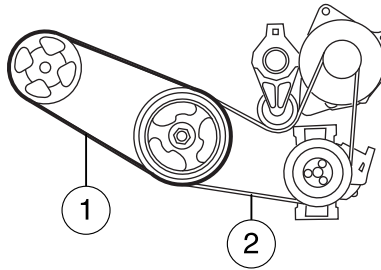

1. Short drivebelt is on first pulley groove closest to engine.
2. Long drivebelt is on second pulley groove farthest from engine.

Maintenance and Specifications

IDENTIFYING YOUR VEHICLE

Safety Compliance Certification Label

The National Highway Traffic Safety Administration Regulations require that a Safety Compliance Certification Label be affixed to a vehicle and prescribe where the Safety Compliance Certification Label may be located. The Safety Compliance Certification Label is located on the structure (B-Pillar) by the trailing edge of the driver's door or the edge of the driver's door.

| MFD. BY FORD MOTOR CO. | | | | | | |
|---|------------------------|--------------------|----------------|-------------------|---------------------|-------|
| DATE: XX/XX | GVWR: XXXXXLB/ XXXXXKG | | | | | |
| FRONT GAWR: XXXXL | REAR GAWR: XXXXLB | | | | | |
| XXXXKG | WITH | XXXXKG | WITH | | | |
| XXXXXX/XXXXXX | TIRES | XXXXXX/XXXXXX | TIRES | | | |
| XXXX.XX | RIMS | XXXX.XX | RIMS | | | |
| AT XXX kPa/XX | PSI COLD | AT XXX kPa/XX | PSI COLD | | | |
| THIS VEHICLE CONFORMS TO ALL APPLICABLE FEDERAL MOTOR VEHICLE SAFETY AND THEFT PREVENTION STANDARDS IN EFFECT ON THE DATE OF MANUFACTURE SHOWN ABOVE. | | | | | | |
| VIN: XXXXXXXXXXXXXXXXX | XXXXX | | | | | |
| TYPE: XXX | XXXXX | | | | | |
|  | | | | | | |
| EXT PNT: XX | RC: XX | DSO: | | | | |
| WB ¹ BRK ¹ | INT TR ¹ | TP/PS ¹ | R ¹ | AXLE ¹ | TR SPR ¹ | XXXXX |
| XXX X | XX | X | XX | X XX | XXX | |
| XXXXXXXXXXXXXX XXX XXXX-XXXXXX-XX | | | | | | |

Vehicle identification number (VIN)

The vehicle identification number is located on the driver side instrument panel.

Please note that in the graphic, XXXX is representative of your vehicle identification number.

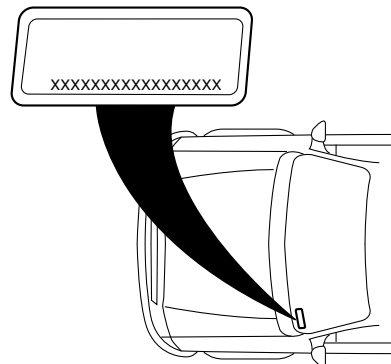

Maintenance and Specifications

The Vehicle Identification Number (VIN) contains the following information:

1. World manufacturer identifier
2. Brake system / Gross Vehicle Weight Rating (GVWR) / Restraint Devices and their location
3. Make, vehicle line, series, body type
4. Engine type
5. Check digit
6. Model year
7. Assembly plant
8. Production sequence number

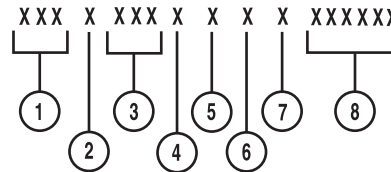

TRANSMISSION CODE DESIGNATIONS

You can find a transmission code on the Safety Compliance Certification Label. The following table tells you which transmission each code represents.

| MFD. BY FORD MOTOR CO. | | | |
|---|----------------------------------|---------------|----------|
| DATE: XX/XX | GVWR: XXXXXLB/ XXXXXKG | | |
| FRONT GAWR: XXXXL | REAR GAWR: XXXXLB | | |
| XXXXKG | WITH XXXXKG | WITH | |
| XXXX/XXXXXX | TIRES: XXXX/XXXXXX | TIRES | |
| XXXX.XX | RIMS: XXXX.XX | RIMS | |
| AT XXX kPa/XX | PSI COLD | AT XXX kPa/XX | PSI COLD |
| THIS VEHICLE CONFORMS TO ALL APPLICABLE FEDERAL MOTOR VEHICLE SAFETY AND THEFT PREVENTION STANDARDS IN EFFECT ON THE DATE OF MANUFACTURE SHOWN ABOVE. | | | |
| VIN: XXXXXXXXXXXXXXXXX | | XXXXX | |
| TYPE: XXX | | XXXXX | |
| | | | |
| EXT PNT: XX | RC: XX | DSO: | |
| WB ¹ BRK ¹ INT TR ¹ TP/PS ¹ R ¹ AXLE ¹ | TR ¹ SPR ¹ | XXXXX | |
| XXX X XX X XX X XX | X XX XXX | | |
| XXXXXXXXXXXX XX XXXX-XXXXXX-XX | | | |

| Description | Code |
|---------------------------------------|------|
| 6-speed automatic transmission (6F50) | J |

Accessories

LINCOLN CUSTOM ACCESSORIES FOR YOUR VEHICLE

A wide selection of Lincoln Custom Accessories are available for your vehicle through your local Lincoln or Ford of Canada dealer. These quality accessories have been specifically engineered to fulfill your automotive needs; they are custom designed to complement the style and aerodynamic appearance of your vehicle. In addition, each accessory is made from high quality materials and meets or exceeds Lincoln's rigorous engineering and safety specifications. Ford Motor Company will repair or replace any properly dealer-installed Lincoln Custom Accessories found to be defective in factory-supplied materials or workmanship during the warranty period, as well as any component damaged by the defective accessories. The accessories will be warranted for whichever provides you the greatest benefit:

- 12 months or 12,000 miles (20,000 km) (whichever occurs first), or
- the remainder of your new vehicle limited warranty.

Contact your dealer for details and a copy of the warranty.

Following is a list of several Lincoln Custom Accessories. Not all accessories are available for all models. To find out what accessories are available for your vehicle, please contact your dealer or visit our online store at: www.lincolnaccessories.com.

Exterior style

- Deflectors
- Custom graphics*

Interior style

- Ambient lighting
- Floor mats
- Custom seat covers*
- Rear seat entertainment*
- Subwoofer*

Lifestyle

- Ash cup / coin holder
- Navigation*
- Cross bars
- SUV camping tent*
- Trailer hitches, wiring harnesses and accessories
- Cargo organization and management
- Roof rack and carriers*
- Rear bumper protector*
- Cargo net*

335

Accessories

Peace of mind

- Remote start
- Keyless entry keypad
- Cargo security shade
- Wheel locks
- Vehicle tracking and recovery*
- Protective seat covers*
- Windshield wiper shaker*
- Bumper and hitch mounted parking sensors*

*Ford Licensed Accessories (FLA) are warranted by the accessory manufacturer's warranty. Ford Licensed Accessories are fully designed and developed by the accessory manufacturer and have not been designed or tested to Ford Motor Company engineering requirements. Contact your Ford dealer for details regarding the manufacturer's limited warranty and/or a copy of the FLA product limited warranty offered by the accessory manufacturer.

For maximum vehicle performance, keep the following information in mind when adding accessories or equipment to your vehicle:

- When adding accessories, equipment, passengers and luggage to your vehicle, do not exceed the total weight capacity of the vehicle or of the front or rear axle (GVWR or GAWR as indicated on the Safety Compliance Certification label). Consult your authorized dealer for specific weight information.
- The Federal Communications Commission (FCC) and Canadian Radio Telecommunications Commission (CRTC) regulate the use of mobile communications systems — such as two-way radios, telephones and theft alarms - that are equipped with radio transmitters. Any such equipment installed in your vehicle should comply with FCC or CRTC regulations and should be installed only by a qualified service technician.
- Mobile communications systems may harm the operation of your vehicle, particularly if they are not properly designed for automotive use.
- To avoid interference with other vehicle functions, such as anti-lock braking systems, amateur radio users who install radios and antennas onto their vehicle should not locate the Amateur Radio Antennas in the area of the driver's side hood.
- Electrical or electronic accessories or components that are added to the vehicle by the authorized dealer or the owner may adversely affect battery performance and durability.

Ford Extended Service Plan

FORD ESP EXTENDED SERVICE PLANS (U.S. ONLY)

More than 30 million Ford, Lincoln, and Mercury owners have discovered the powerful protection of Ford ESP. It is the only extended service plan backed by Ford Motor Company, and provides “peace of mind” protection beyond the New Vehicle Limited Warranty coverage.

Up to 500+ Covered Vehicle Components

There are four, new-vehicle Extended Service Plans with different levels of coverage. Ask your dealer for details.

PremiumCare – Our most comprehensive coverage. With over 500 covered components, this plan is so complete that we generally only discuss what’s not covered!

ExtraCare – Covers 113 components, and includes many high-tech items.

BaseCare – Covers 84 components.

PowertrainCare – Covers 29 critical components.

Ford ESP is honored by all Ford, Lincoln and Mercury Dealers in the U.S. and Canada It’s the only extended service plan authorized and backed by Ford Motor Company. That means you get:

- Reliable, quality service anywhere you go.
- **Factory-trained technicians.**
- **Genuine Ford and Motorcraft® Parts.**

Rental car reimbursement

If your vehicle is kept overnight for covered repairs, you are eligible for rental car coverage, including Bumper-to-Bumper warranty repairs, or manufacturer’s recalls.

Transferable coverage

If you sell your vehicle before your Ford ESP coverage expires, you can transfer any remaining coverage to the new owner. Whenever you’re ready to sell your car, prospective buyers may feel better about taking a risk on your used vehicle. Ford ESP may add resale value!

Plus, **exclusive 24/7 roadside assistance**, including:

- Towing, flat-tire change and battery jump starts.
- Out-of-fuel and lock-out assistance.
- Travel expense reimbursement for lodging, meals and rental car.
- Destination assistance for taxi, shuttle, rental car coverage and emergency transportation.

Ford Extended Service Plan

Ford ESP Can Quickly Pay for Itself

One service bill – the cost of parts and labor – can easily exceed the price of your Ford ESP Service Contract. With Ford ESP, you minimize your risk for unexpected repair bills and rising repair costs.

Avoid the rising cost of properly maintaining your vehicle!

Ford ESP also offers a Premium Maintenance Plan that covers items that **routinely wear out**.

The coverage is prepaid, so you never have to worry about affording your vehicle maintenance. It covers regular checkups, routine inspections, preventive care and replacement of items that require periodic attention for **normal “wear”**:

- **Wiper blades**
- **Spark plugs**
(except California)
- **Clutch disc**
- **Brake pads and linings**
- **Shock absorbers**
- **Belts and hoses**

Contact your selling Ford, Lincoln, or Mercury dealership today so they can customize a Ford Extended Service Plan that fits your driving lifestyle and budget.

Interest free finance options available

Take advantage of our installment payment plan, just a 10% down payment will provide you with an affordable no interest, no-fee payment opportunity.

Ford Extended Service Plan

Get Genuine Peace of Mind with Ford ESP!

To learn more, complete the information below and mail this to:

**Ford ESP
P.O. Box 8072
Royal Oak, MI 48068-9933**

NAME (PLEASE PRINT) _____

ADDRESS _____ APT.NO. _____

CITY _____ STATE _____ ZIP _____

E-MAIL: _____

Ford Extended Service Plan

FORD ESP EXTENDED SERVICE PLANS (CANADA ONLY)

You can get more protection for your vehicle by purchasing a Ford Extended Service Plan (ESP). Ford ESP is the only service contract backed by Ford Motor Company. Depending on the plan you purchase, Ford ESP provides benefits such as:

- Rental reimbursement
- Coverage for certain maintenance and wear items
- Protection against repair costs after your New Vehicle Limited Warranty Coverage expires
- Roadside Assistance benefits

You may purchase Ford ESP from any participating Ford Motor Company dealership. There are several Ford ESP plans available in various time, distance and deductible combinations. Each plan is tailored to fit your own driving needs, including reimbursement for towing and rental.

When you purchase Ford ESP, you receive peace-of-mind protection throughout Canada and the United States, provided by a network of Ford Motor Company dealers.

For more information, visit your local Ford of Canada dealer or www.ford.ca to find the Ford Extended Service Plan that is right for you.

NOTE: Repairs performed outside of Canada and the United States are not eligible for Ford ESP coverage. This information is subject to change.

Scheduled Maintenance Guide

GENERAL MAINTENANCE INFORMATION

Why maintain your vehicle?

This guide describes the scheduled maintenance required for your vehicle. Carefully following this schedule helps protect against major repair expenses resulting from neglect or inadequate maintenance and may also help to increase the value of your vehicle when you sell or trade it.

It is your responsibility to see that all scheduled maintenance is performed and that the materials used meet Ford engineering specifications. Failure to perform scheduled maintenance specific in this guide will invalidate warranty coverage on parts affected by the lack of maintenance. Be sure receipts for completed maintenance are kept with the vehicle and confirmation of the work performed is always recorded in this guide.

Your Ford or Lincoln Mercury dealer has factory-trained technicians who can perform the required maintenance using genuine Ford parts. They are committed to meeting your service needs and to assuring your continuing satisfaction.

Protecting your investment

Maintenance is an investment that will pay dividends in the form of improved reliability, durability and resale value. To ensure the proper performance of your vehicle and its emission control systems, it is imperative that scheduled maintenance be completed at the designated intervals.

For your convenience, your vehicle is equipped with a message center which determines the proper oil change service interval. You should perform the engine oil change as indicated by the instrument cluster message center. The message center will display ENGINE OIL CHANGE SOON or OIL CHANGE REQUIRED to indicate when an oil change is needed. The engine oil change service needs to be completed within two weeks or 500 miles (800 km) after the OIL CHANGE REQUIRED message is displayed. Your oil change service interval can be up to one year or 10,000 miles (16,000 km). Reset your Intelligent Oil Life Monitor™ after each engine oil and filter change; refer to the *Instrument Cluster* chapter.

Scheduled Maintenance Guide

If your message center is prematurely reset or becomes inoperative, you should perform the oil change interval at six months or 5,000 miles (8,000 km) from your last oil change.

Your vehicle is very sophisticated and built with multiple complex performance systems. Every manufacturer develops these systems using different specifications and performance features. That's why it's important to rely upon your Ford or Lincoln Mercury dealership to properly diagnose and repair your vehicle.

Ford Motor Company has recommended maintenance intervals for various parts and component systems based upon engineering testing. Ford Motor Company relies upon this testing to determine the most appropriate mileage for replacement of oils and fluids to protect your vehicle at the lowest overall cost to you and recommends against maintenance schedules that deviate from the scheduled maintenance information.

Ford strongly recommends the use of genuine Ford replacement parts. Parts other than Ford, Motorcraft® or Ford-authorized remanufactured parts that are used for maintenance replacement or for the service of components affecting emission control must be equivalent to genuine Ford Motor Company parts in performance and durability. It is the owner's responsibility to determine the equivalency of such parts. Please consult your *Warranty Guide* for complete warranty information.

Non-Ford approved chemicals or additives are not required for factory recommended maintenance. In fact, Ford Motor Company recommends against the use of such additive products unless specifically recommended by Ford for a particular application.

Oil, fluids and flushing

In many cases, fluid discoloration is a normal operating characteristic and, by itself, does not necessarily indicate a concern or that the fluid needs to be changed. However, discolored fluids that also show signs of overheating and/or foreign material contamination should be inspected immediately by a qualified expert such as the factory-trained technicians at your Ford or Lincoln Mercury dealership. Your vehicle's oils and fluids should be changed at the specified intervals or in conjunction with a repair. Flushing is a viable way to change fluid for many vehicle sub-systems during scheduled maintenance. It is critical that systems are flushed only with new fluid that is the same as that required to fill and operate the system, or using a Ford-approved flushing chemical.

342

Scheduled Maintenance Guide

Genuine Ford parts and service

When planning your maintenance services, consider your Ford and Lincoln Mercury dealership for all your vehicle's needs.

Get the most from your service and maintenance visits

There are a lot of reasons why visiting your Ford or Lincoln Mercury dealership for all your service needs is a great way to help keep your vehicle running great.

Convenience

Many dealerships have extended evening and Saturday hours to make your service visit more convenient. How's that for quality service?

Factory-trained technicians

Ford and Lincoln Mercury service technicians participate in extensive factory-sponsored certification training to help them become experts on the operation of your vehicle. Ask your dealership about the training and certification their technicians have received.

Genuine Ford and Motorcraft® replacement parts

Ford and Lincoln Mercury dealerships stock Ford and Motorcraft® branded replacement parts. These parts meet or exceed Ford Motor Company's specifications, and we stand behind them. Parts installed at your Ford or Lincoln Mercury dealership carry a nationwide, 12 months, 12,000 mile (20,000 km) parts and labor limited warranty. Your dealer can give you details.

Value shopping for your vehicle's maintenance needs

Your dealership recognizes the competitive landscape of maintenance and light repair automotive services. With factory-trained technicians, and one-stop service from routine maintenance like oil changes and tire rotations to repairs like brake service, check out the value your Ford and Lincoln Mercury dealers can offer.

Scheduled Maintenance Guide

WHICH MAINTENANCE SCHEDULE SHOULD YOU FOLLOW?

Owner checks and services

Certain basic maintenance checks and inspections should be performed by the owner or a service technician at the intervals indicated. Service information and supporting specifications are provided in this Owner's Guide.

Any adverse condition should be brought to the attention of your dealer or qualified service technician as soon as possible for the proper service advice. The owner maintenance service checks are generally not covered by warranties so you may be charged for labor, parts or lubricants used.

Maximum oil change interval

- As indicated by the instrument cluster message center (can be up to one year or 10,000 miles [16,000 km])

Engine coolant change interval

- 6 years or 100,000 miles (160,000 km) - change engine coolant (whichever comes first)
- After initial change - change engine coolant every 3 years or 50,000 miles (80,000 km).

Check every month

- Check function of all interior and exterior lights
- Check tires for wear and correct air pressure, including spare tire
- Check windshield washer fluid level
- Check engine oil level

Check every six months

- Check lap/shoulder belts and seat latches for wear and function
- Check parking brake for proper operation
- Check safety warning lamps (brake, ABS, airbag, safety belt) for operation
- Check cooling system fluid level and coolant strength
- Check battery connections and clean if necessary
- Check washer spray, wiper operation and clean all wiper blades (replace as necessary)
- Check and lubricate all hinges, latches and outside locks. Inspect for correct operation
- Check and lubricate door rubber weatherstrips. Inspect for excessive wear
- Check and clean body and door drain holes. Inspect for clogs and obstructions

Scheduled Maintenance Guide

Multi-point inspection

In order to keep your vehicle running right, it is important to have the systems on your vehicle checked regularly. This can help identify potential issues and prevent major problems. Ford Motor Company recommends the following multi-point inspection be performed at every scheduled maintenance interval to help ensure your vehicle keeps running great.

Multi-point inspection - Recommended at every visit

- Check and top-up fluid levels: brake, coolant recovery reservoir, manual and automatic transmission (if equipped with an underhood dipstick), power steering (if equipped) and window washer
- Inspect tires for wear and check air pressure, including spare.
- Check exhaust system for leaks, damage, loose parts and foreign material.
- Check battery performance.
- Check operation of horn, exterior lamps, turn signals and hazard warning lights.
- Check radiator, coolers, heater and air conditioning hoses.
- Inspect windshield washer spray and wiper operation.
- Check windshield for cracks, chips and pitting.
- Inspect for oil and fluid leaks.
- Inspect engine air filter.
- Inspect half shaft dust boots, if equipped.
- Check shocks and struts and other suspension components for leaks and damage.
- Inspect steering and linkage.
- Inspect accessory drive belt(s).
- Inspect clutch operation, if equipped.

Be sure to ask your Ford or Lincoln Mercury dealership service advisor or technician about the multi-point vehicle inspection. It's a comprehensive way to perform a thorough inspection of your vehicle. It's your checklist that gives you immediate feedback on the overall condition of your vehicle. You'll know what's been checked, what's okay, as well as those things that may require future or immediate attention. The multi-point vehicle inspection is one more way to keep your vehicle running great!

Scheduled Maintenance Guide

NORMAL SCHEDULED MAINTENANCE AND LOG

For your convenience, your vehicle is equipped with a message center which determines the proper oil change service interval. You should perform the engine oil change as indicated by the instrument cluster message center. The message center will display ENGINE OIL CHANGE SOON or OIL CHANGE REQUIRED to indicate when an oil change is needed. The engine oil change service needs to be completed within two weeks or 500 miles (800 km) after the OIL CHANGE REQUIRED message is displayed. Your oil change service interval can be up to one year or 10,000 miles (16,000 km). Reset your Intelligent Oil Life Monitor™ after each engine oil and filter change; refer to the *Instrument Cluster* chapter.

If your message center is prematurely reset or becomes inoperative, you should perform the oil change interval at six months or 5,000 miles (8,000 km) from your last oil change.

Scheduled Maintenance Guide

| Oil Change Service Interval* | 1 | 2 | 3 | 4 | 5 | 6 | 7 | 8 | 9 | 10 | 11 | 12 | 13 | 14 | 15 |
|--|---|---|---|---|---|---|---|---|---|----|----|----|----|----|----|
| Change engine oil and filter | • | • | • | • | • | • | • | • | • | • | • | • | • | • | • |
| Rotate tires, inspect tire wear and measure tread depth | • | • | • | • | • | • | • | • | • | • | • | • | • | • | • |
| Inspect wheels and related components for abnormal noise, wear, looseness or drag | • | • | • | • | • | • | • | • | • | • | • | • | • | • | • |
| Perform multi-point inspection (recommended) | • | • | • | • | • | • | • | • | • | • | • | • | • | • | • |
| Inspect automatic transmission fluid level (if equipped with dipstick); consult dealer for requirements | • | • | • | • | • | • | • | • | • | • | • | • | • | • | • |
| Inspect brake pads, shoes, rotors, drums, brake linings, hoses and parking brake | • | • | • | • | • | • | • | • | • | • | • | • | • | • | • |
| Inspect engine cooling system for strength, and hoses | • | • | • | • | • | • | • | • | • | • | • | • | • | • | • |
| Inspect exhaust system and heat shields | • | • | • | • | • | • | • | • | • | • | • | • | • | • | • |
| Inspect half-shaft boots (if equipped) | • | • | • | • | • | • | • | • | • | • | • | • | • | • | • |
| Inspect steering linkage, ball joints, suspension, tie-rod ends, driveshaft and U-joints; lubricate if equipped with grease fittings | • | • | • | • | • | • | • | • | • | • | • | • | • | • | • |
| Inspect cabin air filter (if equipped) | • | • | • | • | • | • | • | • | • | • | • | • | • | • | • |

*Oil change service intervals should be completed as indicated by the instrument cluster message center

Reset your Intelligent Oil Life Monitor™ after each engine oil and filter change; refer to the *Instrument Cluster* chapter

Scheduled Maintenance Guide

Perform the services noted in the following table at the specified time/mileage (km) period either within 3,000 miles (5,000 km) of the OIL CHANGE REQUIRED message appearing in the message center or when the time/mileage (km) reading indicates service is due.

Example #1: The OIL CHANGE REQUIRED message comes on at 28,751 miles (46,270 km); perform the 30,000 mile (48,000 km) automatic transmission fluid replacement.

Example #2: The OIL CHANGE REQUIRED message has **not** come on but the odometer reads 30,000 miles (48,000 km); perform the engine air filter replacement. (i.e., Intelligent Oil Life Monitor™ was reset at 25,000 miles [40,000 km].)

| | |
|--|---|
| Every 20,000 miles (32,000 km) | Replace cabin air filter (if equipped) |
| Every 30,000 miles (48,000 km) | Replace climate-controlled seat filter (if equipped) |
| | Replace engine air filter |
| Every 100,000 miles (160,000 km) | Change engine coolant ¹ |
| | Replace spark plugs |
| | Inspect accessory drive belt(s) ² |
| Every 150,000 miles (240,000 km) | Change automatic transmission fluid and filter (filter not required on 6F35, 6F50, DPS6 and AWF-21 transmissions); consult dealer for requirements |
| | Change manual transmission fluid |
| | Change rear axle fluid (RWD vehicles) |
| | Replace accessory drive belt(s) if not replaced within the last 100,000 miles (160,000 km) |
| | Replace timing belt (Fiesta). Failure to replace timing belt can cause internal engine damage. |
| ¹ Initial replacement at 100,000 miles (160,000 km) or 72 months; every 50,000 miles (80,000 km) or 36 months thereafter | |
| ² Perform a follow-up inspection at 120,000 miles (192,000 km) | |

Scheduled Maintenance Guide

Maintenance schedule log

| | |
|--|--|
| <p style="text-align: center;">DEALER VALIDATION:</p> <p style="text-align: center;">P&A CODE:</p> <p>RO#: HOURS:</p> <p>DATE: MILEAGE:</p> | <p style="text-align: center;">DEALER VALIDATION:</p> <p style="text-align: center;">P&A CODE:</p> <p>RO#: HOURS:</p> <p>DATE: MILEAGE:</p> |
| <p style="text-align: center;">DEALER VALIDATION:</p> <p style="text-align: center;">P&A CODE:</p> <p>RO#: HOURS:</p> <p>DATE: MILEAGE:</p> | <p style="text-align: center;">DEALER VALIDATION:</p> <p style="text-align: center;">P&A CODE:</p> <p>RO#: HOURS:</p> <p>DATE: MILEAGE:</p> |
| <p style="text-align: center;">DEALER VALIDATION:</p> <p style="text-align: center;">P&A CODE:</p> <p>RO#: HOURS:</p> <p>DATE: MILEAGE:</p> | <p style="text-align: center;">DEALER VALIDATION:</p> <p style="text-align: center;">P&A CODE:</p> <p>RO#: HOURS:</p> <p>DATE: MILEAGE:</p> |
| <p style="text-align: center;">DEALER VALIDATION:</p> <p style="text-align: center;">P&A CODE:</p> <p>RO#: HOURS:</p> <p>DATE: MILEAGE:</p> | <p style="text-align: center;">DEALER VALIDATION:</p> <p style="text-align: center;">P&A CODE:</p> <p>RO#: HOURS:</p> <p>DATE: MILEAGE:</p> |
| <p style="text-align: center;">DEALER VALIDATION:</p> <p style="text-align: center;">P&A CODE:</p> <p>RO#: HOURS:</p> <p>DATE: MILEAGE:</p> | <p style="text-align: center;">DEALER VALIDATION:</p> <p style="text-align: center;">P&A CODE:</p> <p>RO#: HOURS:</p> <p>DATE: MILEAGE:</p> |

Scheduled Maintenance Guide

| | |
|---|---|
| <p style="text-align: center;">DEALER VALIDATION:</p> <p style="text-align: center;">P&A CODE:</p> <p>RO#: HOURS:</p> <p>DATE: MILEAGE:</p> | <p style="text-align: center;">DEALER VALIDATION:</p> <p style="text-align: center;">P&A CODE:</p> <p>RO#: HOURS:</p> <p>DATE: MILEAGE:</p> |
| <p style="text-align: center;">DEALER VALIDATION:</p> <p style="text-align: center;">P&A CODE:</p> <p>RO#: HOURS:</p> <p>DATE: MILEAGE:</p> | <p style="text-align: center;">DEALER VALIDATION:</p> <p style="text-align: center;">P&A CODE:</p> <p>RO#: HOURS:</p> <p>DATE: MILEAGE:</p> |
| <p style="text-align: center;">DEALER VALIDATION:</p> <p style="text-align: center;">P&A CODE:</p> <p>RO#: HOURS:</p> <p>DATE: MILEAGE:</p> | <p style="text-align: center;">DEALER VALIDATION:</p> <p style="text-align: center;">P&A CODE:</p> <p>RO#: HOURS:</p> <p>DATE: MILEAGE:</p> |
| <p style="text-align: center;">DEALER VALIDATION:</p> <p style="text-align: center;">P&A CODE:</p> <p>RO#: HOURS:</p> <p>DATE: MILEAGE:</p> | <p style="text-align: center;">DEALER VALIDATION:</p> <p style="text-align: center;">P&A CODE:</p> <p>RO#: HOURS:</p> <p>DATE: MILEAGE:</p> |
| <p style="text-align: center;">DEALER VALIDATION:</p> <p style="text-align: center;">P&A CODE:</p> <p>RO#: HOURS:</p> <p>DATE: MILEAGE:</p> | <p style="text-align: center;">DEALER VALIDATION:</p> <p style="text-align: center;">P&A CODE:</p> <p>RO#: HOURS:</p> <p>DATE: MILEAGE:</p> |

Scheduled Maintenance Guide

| | |
|---|---|
| <p style="text-align: center;">DEALER VALIDATION:</p> <p style="text-align: center;">P&A CODE:</p> <p>RO#: HOURS:</p> <p>DATE: MILEAGE:</p> | <p style="text-align: center;">DEALER VALIDATION:</p> <p style="text-align: center;">P&A CODE:</p> <p>RO#: HOURS:</p> <p>DATE: MILEAGE:</p> |
| <p style="text-align: center;">DEALER VALIDATION:</p> <p style="text-align: center;">P&A CODE:</p> <p>RO#: HOURS:</p> <p>DATE: MILEAGE:</p> | <p style="text-align: center;">DEALER VALIDATION:</p> <p style="text-align: center;">P&A CODE:</p> <p>RO#: HOURS:</p> <p>DATE: MILEAGE:</p> |
| <p style="text-align: center;">DEALER VALIDATION:</p> <p style="text-align: center;">P&A CODE:</p> <p>RO#: HOURS:</p> <p>DATE: MILEAGE:</p> | <p style="text-align: center;">DEALER VALIDATION:</p> <p style="text-align: center;">P&A CODE:</p> <p>RO#: HOURS:</p> <p>DATE: MILEAGE:</p> |
| <p style="text-align: center;">DEALER VALIDATION:</p> <p style="text-align: center;">P&A CODE:</p> <p>RO#: HOURS:</p> <p>DATE: MILEAGE:</p> | <p style="text-align: center;">DEALER VALIDATION:</p> <p style="text-align: center;">P&A CODE:</p> <p>RO#: HOURS:</p> <p>DATE: MILEAGE:</p> |
| <p style="text-align: center;">DEALER VALIDATION:</p> <p style="text-align: center;">P&A CODE:</p> <p>RO#: HOURS:</p> <p>DATE: MILEAGE:</p> | <p style="text-align: center;">DEALER VALIDATION:</p> <p style="text-align: center;">P&A CODE:</p> <p>RO#: HOURS:</p> <p>DATE: MILEAGE:</p> |

Scheduled Maintenance Guide

SPECIAL OPERATING CONDITIONS

If you operate your Ford/Lincoln/Mercury vehicle **primarily** in one of the more demanding **Special Operating Conditions** listed below, you will need to have some items maintained more frequently. If you only **occasionally** operate your vehicle under these conditions, it is not necessary to perform the additional maintenance. For specific recommendations, see your Ford or Lincoln Mercury dealership service advisor or technician.

| Towing a trailer or using a camper or car-top carrier | |
|---|---|
| As required | – Change engine oil and replace oil filter as indicated by message center and perform services as listed in the Normal Scheduled Maintenance chart. |
| Inspect frequently, service as required. | – See axle maintenance items under <i>Exceptions</i> . |
| Every 30,000 miles (48,000 km) | – Change automatic transmission fluid (except 6R80 transmission). |
| Every 60,000 miles (96,000 km) | – Change manual transmission fluid. |

Perform the services noted in the preceding table at the specified time/mileage (km) period either within 3,000 miles (5,000 km) of the OIL CHANGE REQUIRED message appearing in the message center or when the time/mileage (km) reading indicates service is due.

Example #1: The OIL CHANGE REQUIRED message comes on at 28,751 miles (46,270 km); perform the 30,000 mile (48,000 km) automatic transmission fluid replacement.

Example #2: The OIL CHANGE REQUIRED message has **not** come on but the odometer reads 30,000 miles (48,000 km); perform the engine air filter replacement. (i.e., Intelligent Oil Life Monitor™ was reset at 25,000 miles [40,000 km].)

Scheduled Maintenance Guide

Extensive idling and/or low-speed driving for long distances as in heavy commercial use such as delivery, taxi, patrol car or livery

| | |
|--|---|
| As required | – Change engine oil and replace oil filter as indicated by message center and perform services as listed in the Normal Scheduled Maintenance chart (except Fiesta). |
| Inspect frequently, service as required | – Replace cabin air filter (if equipped). – Replace engine air filter. |
| Every 300 hours of engine operation* | – Change engine oil and replace oil filter (Fiesta). |
| Every 30,000 miles (48,000 km) | – Change automatic transmission fluid (except Fiesta and vehicles equipped with a 6R80 transmission). |
| Every 60,000 miles (96,000 km) | – Replace spark plugs. |

* Engine hour meter installation is recommended for these operating conditions.

Perform the services noted in the preceding table at the specified time/mileage (km) period either within 3,000 miles (5,000 km) of the OIL CHANGE REQUIRED message appearing in the message center or when the time/mileage (km) reading indicates service is due.

Example #1: The OIL CHANGE REQUIRED message comes on at 28,751 miles (46,270 km); perform the 30,000 mile (48,000 km) automatic transmission fluid replacement.

Example #2: The OIL CHANGE REQUIRED message has **not** come on but the odometer reads 30,000 miles (48,000 km); perform the engine air filter replacement. (i.e., Intelligent Oil Life Monitor™ was reset at 25,000 miles [40,000 km].)

Scheduled Maintenance Guide

Operating in dusty conditions such as unpaved or dusty roads

- | | |
|---|---|
| Inspect frequently, service as required | – Replace cabin air filter (if equipped). – Replace engine air filter. |
| Every 5,000 miles (8,000 km) | – Inspect the wheels and related components for abnormal noise, wear, looseness or drag. – Rotate tires, inspect tires for wear and measure tread depth. |
| Every 5,000 miles (8,000 km) or 6 months | – Change engine oil and replace oil filter. |
| Every 30,000 miles (48,000 km) | – Change automatic transmission fluid (except Fiesta and vehicles equipped with a 6R80 transmission). |
| Every 50,000 miles (80,000 km) | – Change manual transmission fluid. |

Reset your Intelligent Oil Life Monitor™ after each engine oil and filter change; refer to the *Instrument Cluster* chapter.

Exclusive use of E85 (Flex Fuel Vehicles only)

- | | |
|----------------------------------|--|
| Every oil change interval | – If ran exclusively on E85, fill the fuel tank full with regular unleaded fuel. |
|----------------------------------|--|

Scheduled Maintenance Guide

Special operating condition log

| | |
|---|---|
| <p style="text-align: center;">DEALER VALIDATION:</p> <p style="text-align: center;">P&A CODE:</p> <p>RO#: HOURS:</p> <p>DATE: MILEAGE:</p> | <p style="text-align: center;">DEALER VALIDATION:</p> <p style="text-align: center;">P&A CODE:</p> <p>RO#: HOURS:</p> <p>DATE: MILEAGE:</p> |
| <p style="text-align: center;">DEALER VALIDATION:</p> <p style="text-align: center;">P&A CODE:</p> <p>RO#: HOURS:</p> <p>DATE: MILEAGE:</p> | <p style="text-align: center;">DEALER VALIDATION:</p> <p style="text-align: center;">P&A CODE:</p> <p>RO#: HOURS:</p> <p>DATE: MILEAGE:</p> |
| <p style="text-align: center;">DEALER VALIDATION:</p> <p style="text-align: center;">P&A CODE:</p> <p>RO#: HOURS:</p> <p>DATE: MILEAGE:</p> | <p style="text-align: center;">DEALER VALIDATION:</p> <p style="text-align: center;">P&A CODE:</p> <p>RO#: HOURS:</p> <p>DATE: MILEAGE:</p> |
| <p style="text-align: center;">DEALER VALIDATION:</p> <p style="text-align: center;">P&A CODE:</p> <p>RO#: HOURS:</p> <p>DATE: MILEAGE:</p> | <p style="text-align: center;">DEALER VALIDATION:</p> <p style="text-align: center;">P&A CODE:</p> <p>RO#: HOURS:</p> <p>DATE: MILEAGE:</p> |
| <p style="text-align: center;">DEALER VALIDATION:</p> <p style="text-align: center;">P&A CODE:</p> <p>RO#: HOURS:</p> <p>DATE: MILEAGE:</p> | <p style="text-align: center;">DEALER VALIDATION:</p> <p style="text-align: center;">P&A CODE:</p> <p>RO#: HOURS:</p> <p>DATE: MILEAGE:</p> |

Scheduled Maintenance Guide

| | |
|--|--|
| <p style="text-align: center;">DEALER VALIDATION:</p> <p style="text-align: center;">P&A CODE:</p> <p>RO#: HOURS:</p> <p>DATE: MILEAGE:</p> | <p style="text-align: center;">DEALER VALIDATION:</p> <p style="text-align: center;">P&A CODE:</p> <p>RO#: HOURS:</p> <p>DATE: MILEAGE:</p> |
| <p style="text-align: center;">DEALER VALIDATION:</p> <p style="text-align: center;">P&A CODE:</p> <p>RO#: HOURS:</p> <p>DATE: MILEAGE:</p> | <p style="text-align: center;">DEALER VALIDATION:</p> <p style="text-align: center;">P&A CODE:</p> <p>RO#: HOURS:</p> <p>DATE: MILEAGE:</p> |
| <p style="text-align: center;">DEALER VALIDATION:</p> <p style="text-align: center;">P&A CODE:</p> <p>RO#: HOURS:</p> <p>DATE: MILEAGE:</p> | <p style="text-align: center;">DEALER VALIDATION:</p> <p style="text-align: center;">P&A CODE:</p> <p>RO#: HOURS:</p> <p>DATE: MILEAGE:</p> |
| <p style="text-align: center;">DEALER VALIDATION:</p> <p style="text-align: center;">P&A CODE:</p> <p>RO#: HOURS:</p> <p>DATE: MILEAGE:</p> | <p style="text-align: center;">DEALER VALIDATION:</p> <p style="text-align: center;">P&A CODE:</p> <p>RO#: HOURS:</p> <p>DATE: MILEAGE:</p> |
| <p style="text-align: center;">DEALER VALIDATION:</p> <p style="text-align: center;">P&A CODE:</p> <p>RO#: HOURS:</p> <p>DATE: MILEAGE:</p> | <p style="text-align: center;">DEALER VALIDATION:</p> <p style="text-align: center;">P&A CODE:</p> <p>RO#: HOURS:</p> <p>DATE: MILEAGE:</p> |

Scheduled Maintenance Guide

EXCEPTIONS

In addition, there are several exceptions to the Normal Schedule. They are listed below:

Normal vehicle axle maintenance

- Rear axles and power take-off (PTO) units containing synthetic lubricant and light duty trucks equipped with Ford-design axles are lubricated for life. These lubricants are not to be checked or changed unless a leak is suspected, service is required or the axle assembly has been submerged in water. The axle and PTO lubricant should be changed anytime the axle and PTO have been submerged in water. During extended trailer tow operation above 70°F (21°C) ambient and wide open throttle for extended periods above 45 mph (72 km/h), non-synthetic rear axle lubricants should be replaced every 3,000 miles (4,800 km) or three months, whichever occurs first. The 3,000 mile (4,800 km) lubricant change interval may be waived if the axle was filled with 75W140 synthetic gear lubricant meeting Ford specification WSL-M2C192-A, part number FITZ-19580-B or equivalent. Add friction modifier XL-3 (EST-M2C118-A) or equivalent for complete refill of Traction-Lok rear axles (refer to *Maintenance product and specifications* in the *Maintenance and Specifications* chapter for details). The axle lubricant should be changed anytime an axle has been submerged in water.

Police/Taxi/Livery vehicle axle maintenance

- Replace rear axle lubricant every 100,000 miles (160,000 km). Rear axle lubricant change may be waived if the axle was filled with 75W140 synthetic gear lubricant meeting Ford specification WSL-M2C192-A, part number FITZ-19580-B or equivalent. Add four ounces (118 mL) of friction modifier XL-3 (EST-M2C118-A) or equivalent for complete refill of Traction-Lok rear axles. The axle lubricant should be changed anytime the axle has been submerged in water.

California fuel filter replacement

- If vehicle is registered in California, the California Air Resources Board has determined that the failure to perform this maintenance item will not nullify the emission warranty or limit recall liability prior to the completion of the vehicle's useful life. Ford Motor Company, however, urges you to have all recommended maintenance services performed at the specified intervals and to record all vehicle service.

Hot climate oil change intervals

- If operating conditions are normal and you drive your Ford, Lincoln or Mercury vehicle under typical, everyday conditions **and** you are using an API performance category oil of SL or later (for example SM, etc.) then you can follow the 7,500 mile (12,000 km) normal service oil change intervals schedule. Vehicles operating in the Middle East, North Africa, Sub-Saharan Africa or locations with similar climates must follow the oil change interval of 3,000 mile (5,000 km) if the owner is using oils defined by the American Petroleum Institute (API) performance category of API SK or earlier (for example SJ, etc.).

Engine air filter & cabin air filter replacement

- Engine air filter and cabin air filter life is dependent on exposure to dusty and dirty conditions. Vehicles operated in these conditions will require frequent inspection and replacement of the engine air filter and cabin air filter.

Scheduled Maintenance Guide

COOLANT CHANGE RECORD

Engine coolant

- 6 years or 100,000 miles (160,000 km) - change coolant (whichever comes first).
- After initial change - change coolant every 3 years or 50,000 miles (80,000 km).

Scheduled Maintenance Guide

Engine coolant change log

| | |
|--|--|
| <p style="text-align: center;">DEALER VALIDATION:</p> <p style="text-align: center;">P&A CODE:</p> <p>RO#: HOURS:</p> <p>DATE: MILEAGE:</p> | <p style="text-align: center;">DEALER VALIDATION:</p> <p style="text-align: center;">P&A CODE:</p> <p>RO#: HOURS:</p> <p>DATE: MILEAGE:</p> |
| <p style="text-align: center;">DEALER VALIDATION:</p> <p style="text-align: center;">P&A CODE:</p> <p>RO#: HOURS:</p> <p>DATE: MILEAGE:</p> | <p style="text-align: center;">DEALER VALIDATION:</p> <p style="text-align: center;">P&A CODE:</p> <p>RO#: HOURS:</p> <p>DATE: MILEAGE:</p> |
| <p style="text-align: center;">DEALER VALIDATION:</p> <p style="text-align: center;">P&A CODE:</p> <p>RO#: HOURS:</p> <p>DATE: MILEAGE:</p> | <p style="text-align: center;">DEALER VALIDATION:</p> <p style="text-align: center;">P&A CODE:</p> <p>RO#: HOURS:</p> <p>DATE: MILEAGE:</p> |
| <p style="text-align: center;">DEALER VALIDATION:</p> <p style="text-align: center;">P&A CODE:</p> <p>RO#: HOURS:</p> <p>DATE: MILEAGE:</p> | <p style="text-align: center;">DEALER VALIDATION:</p> <p style="text-align: center;">P&A CODE:</p> <p>RO#: HOURS:</p> <p>DATE: MILEAGE:</p> |
| <p style="text-align: center;">DEALER VALIDATION:</p> <p style="text-align: center;">P&A CODE:</p> <p>RO#: HOURS:</p> <p>DATE: MILEAGE:</p> | <p style="text-align: center;">DEALER VALIDATION:</p> <p style="text-align: center;">P&A CODE:</p> <p>RO#: HOURS:</p> <p>DATE: MILEAGE:</p> |

Index

A

Accessory delay65
Adaptive Cruise Control69
AdvanceTrac218
Air cleaner filter324, 328
Air conditioning36
Airbag supplemental restraint
system143–144, 152, 155
 and child safety seats145
 description144, 152, 155
 disposal158
 driver airbag146, 152, 156
 indicator light151, 154, 158
 operation146, 152, 156
 passenger airbag146, 152, 156
 side airbag152
All Wheel Drive (AWD),
driving off road246
Antifreeze
(see Engine coolant)304
Anti-lock brake system
(see Brakes)216
Anti-theft system112, 114
 arming the system112, 114
 disarming a triggered
 system114
Automatic transmission
 driving an automatic
 overdrive226
 fluid, adding322
 fluid, checking322
 fluid, refill capacities329
 fluid, specification329
 Selectshift (SST)227
Auxiliary power point62
Axle
 lubricant specifications329

B

Battery301
 acid, treating emergencies301
 jumping a disabled battery272
 maintenance-free301
 replacement, specifications ...328
 servicing301
Belt-Minder®139
Blind Spot Information
System240
Blind spot mirror239
Booster seats172
Brakes216
 anti-lock216
 anti-lock brake system (ABS)
 warning light217
 fluid, checking and adding322
 fluid, refill capacities329
 fluid, specifications329
 lubricant specifications329
 parking217
 shift interlock224
Bulbs51

C

Capacities for refilling fluids329
Cargo management system89
Cargo net89
Cell phone use9
Changing a tire265, 268
Child safety seats163
 attaching with tether
 straps169
 in front seat163
 in rear seat163
 LATCH167
361

Index

- recommendations161
 - Child safety seats - booster seats172
 - Cleaning your vehicle
 - engine compartment287
 - instrument panel289
 - interior290
 - plastic parts288
 - safety belts290
 - washing286
 - waxing286
 - wheels287
 - wiper blades288
 - Climate control (see Air conditioning or Heating)36
 - Collision Warning System236
 - Console62
 - overhead61
 - Controls
 - power seat119
 - steering column77
 - Convertible
 - cleaning289
 - Coolant
 - checking and adding304
 - refill capacities307, 329
 - specifications329
 - Cross Traffic Alert240
 - Cruise control (see Speed control)67
 - Cupholder(s)127
 - Customer Assistance254
 - Ford Extended Service Plan337, 340
 - Getting assistance outside the U.S. and Canada282
 - Getting roadside assistance ...254
 - 362
 - Getting the service you need278
 - Ordering additional owner's literature284
 - Utilizing the Mediation/Arbitration Program282
- ### D
- Daytime running lamps (see Lamps)46
 - Dipstick
 - automatic transmission fluid322
 - engine oil298
 - Driving under special conditions229, 248, 251
 - sand249
 - snow and ice251
 - through water250, 253
- ### E
- Electronic message center18
 - Emergencies, roadside
 - jump-starting272
 - running out of fuel272, 314
 - Emission control system318
 - Engine332
 - cleaning287
 - coolant304
 - fail-safe cooling308
 - idle speed control301
 - lubrication specifications329
 - refill capacities329
 - service points296–297
 - Engine block heater214
 - Engine oil298
 - checking and adding298

Index

- dipstick298
- filter, specifications300, 328
- recommendations300
- refill capacities329
- specifications329
- Event data recording7
- Exhaust fumes214
- F**
- Fail safe cooling308
- Fleet MyKey programming91
- Floor mats83–84
- Fluid capacities329
- Fog lamps46
- Four-Wheel Drive vehicles
 - driving off road247
- Fuel309
 - calculating fuel economy315
 - cap311
 - capacity329
 - choosing the right fuel312
 - detergent in fuel313
 - filler funnel314
 - filling your vehicle with
 - fuel309, 311, 316
 - filter, specifications309, 328
 - fuel pump shut-off255
 - improving fuel economy315
 - octane rating313, 332
 - quality313
 - running out of fuel272, 314
 - safety information relating to automotive fuels309
- Fuses256–257
- G**
- Garage door opener79
- Gas cap (see Fuel cap)311
- Gas mileage (see Fuel economy)315
- Gauges17
- H**
- Hazard flashers255
- Head restraints124
- Headlamps44
 - aiming47–48
 - autolamp system45
 - bulb specifications51
 - daytime running lights46
 - flash to pass46
 - high beam46
 - replacing bulbs52
 - turning on and off44
- Heated steering wheel41
- Heating
 - heating and air conditioning system36
- Hill start assist228
- Homelink wireless control system80
- Hood295
- I**
- Ignition210, 332
- Illuminated visor mirror61
- Infant seats (see Safety seats)163
- Inspection/maintenance (I/M) testing320
363

Index

- Instrument panel
 - cleaning289
 - cluster12
 - lighting up panel and interior47
- Intelligent Access Key91
- Intelligent Access with push button start102
- J**
- Jack265
 - positioning265
 - storage265
- Jump-starting your vehicle272
- K**
- Keyless entry system
 - autolock98
 - keypad110
 - locking and unlocking doors111
 - programming entry code110
- Keys112
 - positions of the ignition210
- L**
- Lamps
 - autolamp system45
 - bulb replacement specifications chart51
 - daytime running light46
 - fog lamps46
 - headlamps44
 - headlamps, flash to pass46
 - instrument panel, dimming47
 - interior lamps50, 52
 - replacing bulbs52
- LATCH anchors167
- 364
- Liftgate84, 89–90, 104
- Lights, warning and indicator12
 - anti-lock brakes (ABS)217
- Load limits198
- Locks
 - autolock98
 - childproof101
 - doors97
- Lubricant specifications329
- Lug nuts271
- Lumbar support, seats120
- M**
- Message center18
 - warning messages27
- Mirrors65–66
 - automatic dimming rearview mirror65
 - fold away67
 - heated66
 - programmable memory105
 - side view mirrors (power)66
- Moon roof78
- Motorcraft® parts293, 328
- MyKey91
- MyLincoln Touch™ system35
- O**
- Octane rating313
- Oil (see Engine oil)298
- Overdrive226
- P**
- Parental MyKey programming ...91
- Parking brake217

Index

- Parts
(see Motorcraft® parts)328
- Passenger Occupant
Classification Sensor130
- Power distribution box
(see Fuses)260
- Power door locks97
- Power liftgate84
- Power mirrors66
- Power point62
- Power steering224
fluid, checking and adding321
fluid, refill capacity329
fluid, specifications329
- Power Windows63
- Push button start system212
- R**
- Rear-view camera system232
- Recommendations for
attaching safety restraints for
children161
- Relays256
- Remote entry system101–102
illuminated entry107
locking/unlocking
doors103–104
opening the trunk104
- Remote start108
replacement/additional
transmitters107
replacing the batteries106
- Remote start108
- Remote start climate
operation42
- Reverse sensing system230
- Roadside assistance254
- Roof rack90
- S**
- Safety belts (see Safety
restraints)129, 132–134,
136–137
- Safety Canopy152, 155
- Safety defects, reporting285
- Safety restraints129, 132–134,
136–137
Belt-Minder®139
extension assembly137
for adults133–134, 136
for children158
Occupant Classification
Sensor130
warning light and chime139
- Safety restraints - LATCH
anchors167
- Safety seats for children163
- Safety Compliance
Certification Label333
- Scheduled Maintenance Guide
Normal Scheduled
Maintenance and Log347
What Maintenance Schedule
Should You Follow?344
- Seats116
child safety seats163
cleaning291
climate control122
easy access/easyout
feature124
front seats121
heated128
memory seat105, 123
- Second-row power fold seat125
365

Index

- SecuriCode keyless entry system110
- SecuriLock passive anti-theft system112
- Servicing your vehicle294
- SOS Post Crash Alert158
- Spare tire
(see Changing the Tire)268
- Spark plugs, specifications328, 332
- Specification chart, lubricants329
- Speed control67
- Starting your vehicle210–211
 - jump starting272
 - push button start system212
- Steering wheel
 - controls77
 - tilting59
- T**
- Tilt steering wheel59
- Tire Pressure Monitoring System (TPMS)
 - Tires, Wheels and Loading193
- Tires178–179, 265
 - alignment186
 - care182
 - changing265, 268
 - checking the pressure182
 - inflating180
 - label192
 - replacing184
 - rotating186
 - safety practices185
 - sidewall information187
 - snow tires and chains197
 - spare tire265, 268
 - terminology179
 - tire grades179
 - treadwear178, 183
- Touchscreen features
(climate)39
- Towing205
 - recreational towing209
 - trailer towing205
 - wrecker276
- Transmission226
 - brake-shift interlock (BSI)224
 - fluid, checking and adding
(automatic)322
 - fluid, refill capacities329
 - lubricant specifications329
- Turn signal49
- U**
- Universal garage door opener79
- V**
- Vehicle Identification Number (VIN)333
- Vehicle loading198
- Ventilating your vehicle214

Index

W

- Warning lights (see Lights)12
- Washer fluid297
- Water, Driving through253
- Windows
 - power63
 - rear wiper/washer59
- Windshield washer fluid and wipers57
 - checking and adding fluid297
 - replacing wiper blades ...297–298
- Wrecker towing276

Free Manuals Download Website

<http://myh66.com>

<http://usermanuals.us>

<http://www.somanuals.com>

<http://www.4manuals.cc>

<http://www.manual-lib.com>

<http://www.404manual.com>

<http://www.luxmanual.com>

<http://aubethermostatmanual.com>

Golf course search by state

<http://golfingnear.com>

Email search by domain

<http://emailbydomain.com>

Auto manuals search

<http://auto.somanuals.com>

TV manuals search

<http://tv.somanuals.com>