

# Square Wave TIG 175

For use with machines having Code Numbers: **10457**

## Safety Depends on You

Lincoln arc welding and cutting equipment is designed and built with safety in mind. However, your overall safety can be increased by proper installation ... and thoughtful operation on your part. **DO NOT INSTALL, OPERATE OR REPAIR THIS EQUIPMENT WITHOUT READING THIS MANUAL AND THE SAFETY PRECAUTIONS CONTAINED THROUGHOUT.** And, most importantly, think before you act and be careful.

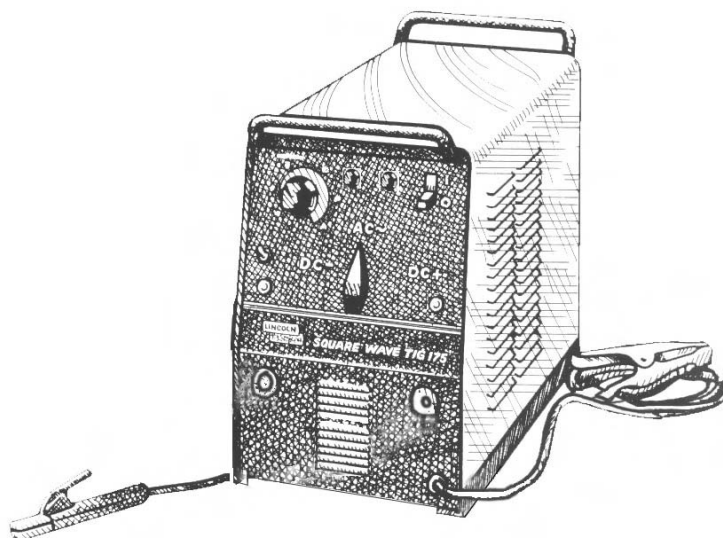

Date of Purchase: \_\_\_\_\_

Serial Number: \_\_\_\_\_

Code Number: \_\_\_\_\_

Model: \_\_\_\_\_

Where Purchased: \_\_\_\_\_

## OPERATOR'S MANUAL



• World's Leader in Welding and Cutting Products •

• Sales and Service through Subsidiaries and Distributors Worldwide •

Cleveland, Ohio 44117-1199 U.S.A. TEL: 216.481.8100 FAX: 216.486.1751 WEB SITE: [www.lincolnelectric.com](http://www.lincolnelectric.com)

Download from [www.Somanuals.com](http://www.Somanuals.com). All Manuals Search And Download.

**⚠ WARNING**

**⚠ CALIFORNIA PROPOSITION 65 WARNINGS ⚠**

For Diesel Engines: Diesel engine exhaust and some of its constituents are known to the State of California to cause cancer, birth defects, and other reproductive harm.

For Gasoline Engines: The engine exhaust from this product contains chemicals known to the State of California to cause cancer, birth defects, or other reproductive harm.

**ARC WELDING CAN BE HAZARDOUS. PROTECT YOURSELF AND OTHERS FROM POSSIBLE SERIOUS INJURY OR DEATH. KEEP CHILDREN AWAY. PACEMAKER WEARERS SHOULD CONSULT WITH THEIR DOCTOR BEFORE OPERATING.**

Read and understand the following safety highlights. For additional safety information, it is strongly recommended that you purchase a copy of "Safety in Welding & Cutting - ANSI Standard Z49.1" from the American Welding Society, P.O. Box 351040, Miami, Florida 33135 or CSA Standard W117.2-1974. A Free copy of "Arc Welding Safety" booklet E205 is available from the Lincoln Electric Company, 22801 St. Clair Avenue, Cleveland, Ohio 44117-1199.

**BE SURE THAT ALL INSTALLATION, OPERATION, MAINTENANCE AND REPAIR PROCEDURES ARE PERFORMED ONLY BY QUALIFIED INDIVIDUALS.**



### FOR ENGINE powered equipment.

1.a. Turn the engine off before troubleshooting and maintenance work unless the maintenance work requires it to be running.

---



1.b. Operate engines in open, well-ventilated areas or vent the engine exhaust fumes outdoors.

---



1.c. Do not add the fuel near an open flame welding arc or when the engine is running. Stop the engine and allow it to cool before refueling to prevent spilled fuel from vaporizing on contact with hot engine parts and igniting. Do not spill fuel when filling tank. If fuel is spilled, wipe it up and do not start engine until fumes have been eliminated.

---

1.d. Keep all equipment safety guards, covers and devices in position and in good repair. Keep hands, hair, clothing and tools away from V-belts, gears, fans and all other moving parts when starting, operating or repairing equipment.

---

1.e. In some cases it may be necessary to remove safety guards to perform required maintenance. Remove guards only when necessary and replace them when the maintenance requiring their removal is complete. Always use the greatest care when working near moving parts.

---



1.f. Do not put your hands near the engine fan. Do not attempt to override the governor or idler by pushing on the throttle control rods while the engine is running.

---

1.g. To prevent accidentally starting gasoline engines while turning the engine or welding generator during maintenance work, disconnect the spark plug wires, distributor cap or magneto wire as appropriate.



1.h. To avoid scalding, do not remove the radiator pressure cap when the engine is hot.



### ELECTRIC AND MAGNETIC FIELDS may be dangerous

2.a. Electric current flowing through any conductor causes localized Electric and Magnetic Fields (EMF). Welding current creates EMF fields around welding cables and welding machines

2.b. EMF fields may interfere with some pacemakers, and welders having a pacemaker should consult their physician before welding.

2.c. Exposure to EMF fields in welding may have other health effects which are now not known.

2.d. All welders should use the following procedures in order to minimize exposure to EMF fields from the welding circuit:

- 2.d.1. Route the electrode and work cables together - Secure them with tape when possible.
- 2.d.2. Never coil the electrode lead around your body.
- 2.d.3. Do not place your body between the electrode and work cables. If the electrode cable is on your right side, the work cable should also be on your right side.
- 2.d.4. Connect the work cable to the workpiece as close as possible to the area being welded.
- 2.d.5. Do not work next to welding power source.

Mar '95



### ELECTRIC SHOCK can kill.

3.a. The electrode and work (or ground) circuits are electrically "hot" when the welder is on. Do not touch these "hot" parts with your bare skin or wet clothing. Wear dry, hole-free gloves to insulate hands.

3.b. Insulate yourself from work and ground using dry insulation. Make certain the insulation is large enough to cover your full area of physical contact with work and ground.

**In addition to the normal safety precautions, if welding must be performed under electrically hazardous conditions (in damp locations or while wearing wet clothing; on metal structures such as floors, gratings or scaffolds; when in cramped positions such as sitting, kneeling or lying, if there is a high risk of unavoidable or accidental contact with the workpiece or ground) use the following equipment:**

- Semiautomatic DC Constant Voltage (Wire) Welder.
- DC Manual (Stick) Welder.
- AC Welder with Reduced Voltage Control.

3.c. In semiautomatic or automatic wire welding, the electrode, electrode reel, welding head, nozzle or semiautomatic welding gun are also electrically "hot".

3.d. Always be sure the work cable makes a good electrical connection with the metal being welded. The connection should be as close as possible to the area being welded.

3.e. Ground the work or metal to be welded to a good electrical (earth) ground.

3.f. Maintain the electrode holder, work clamp, welding cable and welding machine in good, safe operating condition. Replace damaged insulation.

3.g. Never dip the electrode in water for cooling.

3.h. Never simultaneously touch electrically "hot" parts of electrode holders connected to two welders because voltage between the two can be the total of the open circuit voltage of both welders.

3.i. When working above floor level, use a safety belt to protect yourself from a fall should you get a shock.

3.j. Also see Items 6.c. and 8.



### ARC RAYS can burn.

4.a. Use a shield with the proper filter and cover plates to protect your eyes from sparks and the rays of the arc when welding or observing open arc welding. Headshield and filter lens should conform to ANSI Z87.1 standards.

4.b. Use suitable clothing made from durable flame-resistant material to protect your skin and that of your helpers from the arc rays.

4.c. Protect other nearby personnel with suitable, non-flammable screening and/or warn them not to watch the arc nor expose themselves to the arc rays or to hot spatter or metal.



### FUMES AND GASES can be dangerous.

5.a. Welding may produce fumes and gases hazardous to health. Avoid breathing these fumes and gases. When welding, keep your head out of the fume. Use enough ventilation and/or exhaust at the arc to keep

fumes and gases away from the breathing zone. **When welding with electrodes which require special ventilation such as stainless or hard facing (see instructions on container or MSDS) or on lead or cadmium plated steel and other metals or coatings which produce highly toxic fumes, keep exposure as low as possible and below Threshold Limit Values (TLV) using local exhaust or mechanical ventilation. In confined spaces or in some circumstances, outdoors, a respirator may be required. Additional precautions are also required when welding on galvanized steel.**

5.b. Do not weld in locations near chlorinated hydrocarbon vapors coming from degreasing, cleaning or spraying operations. The heat and rays of the arc can react with solvent vapors to form phosgene, a highly toxic gas, and other irritating products.

5.c. Shielding gases used for arc welding can displace air and cause injury or death. Always use enough ventilation, especially in confined areas, to insure breathing air is safe.

5.d. Read and understand the manufacturer's instructions for this equipment and the consumables to be used, including the material safety data sheet (MSDS) and follow your employer's safety practices. MSDS forms are available from your welding distributor or from the manufacturer.

5.e. Also see item 1.b.

Mar '95

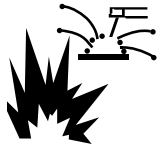

### WELDING SPARKS can cause fire or explosion.

6.a. Remove fire hazards from the welding area.

If this is not possible, cover them to prevent the welding sparks from starting a fire.

Remember that welding sparks and hot materials from welding can easily go through small cracks and openings to adjacent areas. Avoid welding near hydraulic lines. Have a fire extinguisher readily available.

6.b. Where compressed gases are to be used at the job site, special precautions should be used to prevent hazardous situations. Refer to "Safety in Welding and Cutting" (ANSI Standard Z49.1) and the operating information for the equipment being used.

6.c. When not welding, make certain no part of the electrode circuit is touching the work or ground. Accidental contact can cause overheating and create a fire hazard.

6.d. Do not heat, cut or weld tanks, drums or containers until the proper steps have been taken to insure that such procedures will not cause flammable or toxic vapors from substances inside. They can cause an explosion even though they have been "cleaned". For information, purchase "Recommended Safe Practices for the Preparation for Welding and Cutting of Containers and Piping That Have Held Hazardous Substances", AWS F4.1 from the American Welding Society (see address above).

6.e. Vent hollow castings or containers before heating, cutting or welding. They may explode.

6.f. Sparks and spatter are thrown from the welding arc. Wear oil free protective garments such as leather gloves, heavy shirt, cuffless trousers, high shoes and a cap over your hair. Wear ear plugs when welding out of position or in confined places. Always wear safety glasses with side shields when in a welding area.

6.g. Connect the work cable to the work as close to the welding area as practical. Work cables connected to the building framework or other locations away from the welding area increase the possibility of the welding current passing through lifting chains, crane cables or other alternate circuits. This can create fire hazards or overheat lifting chains or cables until they fail.

6.h. Also see item 1.c.

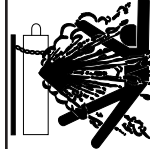

### CYLINDER may explode if damaged.

7.a. Use only compressed gas cylinders containing the correct shielding gas for the process used and properly operating regulators designed for the gas and pressure used. All hoses, fittings, etc. should be suitable for the application and maintained in good condition.

7.b. Always keep cylinders in an upright position securely chained to an undercarriage or fixed support.

7.c. Cylinders should be located:

- Away from areas where they may be struck or subjected to physical damage.

- A safe distance from arc welding or cutting operations and any other source of heat, sparks, or flame.

7.d. Never allow the electrode, electrode holder or any other electrically "hot" parts to touch a cylinder.

7.e. Keep your head and face away from the cylinder valve outlet when opening the cylinder valve.

7.f. Valve protection caps should always be in place and hand tight except when the cylinder is in use or connected for use.

7.g. Read and follow the instructions on compressed gas cylinders, associated equipment, and CGA publication P-1, "Precautions for Safe Handling of Compressed Gases in Cylinders," available from the Compressed Gas Association 1235 Jefferson Davis Highway, Arlington, VA 22202.



### FOR ELECTRICALLY powered equipment.

8.a. Turn off input power using the disconnect switch at the fuse box before working on the equipment.

8.b. Install equipment in accordance with the U.S. National Electrical Code, all local codes and the manufacturer's recommendations.

8.c. Ground the equipment in accordance with the U.S. National Electrical Code and the manufacturer's recommendations.

Mar '95

## PRÉCAUTIONS DE SÛRETÉ

Pour votre propre protection lire et observer toutes les instructions et les précautions de sûreté spécifiques qui paraissent dans ce manuel aussi bien que les précautions de sûreté générales suivantes:

### Sûreté Pour Soudage A L'Arc

1. Protégez-vous contre la secousse électrique:
  - a. Les circuits à l'électrode et à la pièce sont sous tension quand la machine à souder est en marche. Eviter toujours tout contact entre les parties sous tension et la peau nue ou les vêtements mouillés. Porter des gants secs et sans trous pour isoler les mains.
  - b. Faire très attention de bien s'isoler de la masse quand on soude dans des endroits humides, ou sur un plancher métallique ou des grilles métalliques, principalement dans les positions assis ou couché pour lesquelles une grande partie du corps peut être en contact avec la masse.
  - c. Maintenir le porte-électrode, la pince de masse, le câble de soudage et la machine à souder en bon et sûr état de fonctionnement.
  - d. Ne jamais plonger le porte-électrode dans l'eau pour le refroidir.
  - e. Ne jamais toucher simultanément les parties sous tension des porte-électrodes connectés à deux machines à souder parce que la tension entre les deux pinces peut être le total de la tension à vide des deux machines.
  - f. Si on utilise la machine à souder comme une source de courant pour soudage semi-automatique, ces précautions pour le porte-électrode s'appliquent aussi au pistolet de soudage.
2. Dans le cas de travail au dessus du niveau du sol, se protéger contre les chutes dans le cas où on reçoit un choc. Ne jamais enrouler le câble-électrode autour de n'importe quelle partie du corps.
3. Un coup d'arc peut être plus sévère qu'un coup de soleil, donc:
  - a. Utiliser un bon masque avec un verre filtrant approprié ainsi qu'un verre blanc afin de se protéger les yeux du rayonnement de l'arc et des projections quand on soude ou quand on regarde l'arc.
  - b. Porter des vêtements convenables afin de protéger la peau de soudeur et des aides contre le rayonnement de l'arc.
  - c. Protéger l'autre personnel travaillant à proximité au soudage à l'aide d'écrans appropriés et non-inflammables.
4. Des gouttes de laitier en fusion sont émises de l'arc de soudage. Se protéger avec des vêtements de protection libres de l'huile, tels que les gants en cuir, chemise épaisse, pantalons sans revers, et chaussures montantes.
5. Toujours porter des lunettes de sécurité dans la zone de soudage. Utiliser des lunettes avec écrans latéraux dans les zones où l'on pique le laitier.

6. Eloigner les matériaux inflammables ou les recouvrir afin de prévenir tout risque d'incendie dû aux étincelles.
7. Quand on ne soude pas, poser la pince à un endroit isolé de la masse. Un court-circuit accidentel peut provoquer un échauffement et un risque d'incendie.
8. S'assurer que la masse est connectée le plus près possible de la zone de travail qu'il est pratique de le faire. Si on place la masse sur la charpente de la construction ou d'autres endroits éloignés de la zone de travail, on augmente le risque de voir passer le courant de soudage par les chaînes de levage, câbles de grue, ou autres circuits. Cela peut provoquer des risques d'incendie ou d'échauffement des chaînes et des câbles jusqu'à ce qu'ils se rompent.
9. Assurer une ventilation suffisante dans la zone de soudage. Ceci est particulièrement important pour le soudage de tôles galvanisées plombées, ou cadmiées ou tout autre métal qui produit des fumées toxiques.
10. Ne pas souder en présence de vapeurs de chlore provenant d'opérations de dégraissage, nettoyage ou pistolage. La chaleur ou les rayons de l'arc peuvent réagir avec les vapeurs du solvant pour produire du phosgène (gas fortement toxique) ou autres produits irritants.
11. Pour obtenir de plus amples renseignements sur la sûreté, voir le code "Code for safety in welding and cutting" CSA Standard W 117.2-1974.

## PRÉCAUTIONS DE SÛRETÉ POUR LES MACHINES À SOUDER À TRANSFORMATEUR ET À REDRESSEUR

1. Relier à la terre le châssis du poste conformément au code de l'électricité et aux recommandations du fabricant. Le dispositif de montage ou la pièce à souder doit être branché à une bonne mise à la terre.
2. Autant que possible, l'installation et l'entretien du poste seront effectués par un électricien qualifié.
3. Avant de faire des travaux à l'intérieur de poste, la débrancher à l'interrupteur à la boîte de fusibles.
4. Garder tous les couvercles et dispositifs de sûreté à leur place.

Mar. '93

# Thank You

for selecting a **QUALITY** product by Lincoln Electric. We want you to take pride in operating this Lincoln Electric Company product ••• as much pride as we have in bringing this product to you!

## **Please Examine Carton and Equipment For Damage Immediately**

When this equipment is shipped, title passes to the purchaser upon receipt by the carrier. Consequently, Claims for material damaged in shipment must be made by the purchaser against the transportation company at the time the shipment is received.

Please record your equipment identification information below for future reference. This information can be found on your machine nameplate.

Model Name & Number \_\_\_\_\_

Code & Serial Number \_\_\_\_\_

Date of Purchase \_\_\_\_\_

Whenever you request replacement parts for or information on this equipment always supply the information you have recorded above.

**Read this Operators Manual completely** before attempting to use this equipment. Save this manual and keep it handy for quick reference. Pay particular attention to the safety instructions we have provided for your protection. The level of seriousness to be applied to each is explained below:

### **⚠ WARNING**

This statement appears where the information **must** be followed **exactly** to avoid **serious personal injury** or **loss of life**.

### **⚠ CAUTION**

This statement appears where the information **must** be followed to avoid **minor personal injury** or **damage to this equipment**.



## TABLE OF CONTENTS

	Page
<b>SAFETY .....</b>	<b>i-iv</b>
<b>INSTALLATION SECTION .....</b>	<b>1</b>
TECHNICAL SPECIFICATIONS.....	1
SELECT SUITABLE LOCATION.....	2
STACKING .....	2
LIFTING & MOVING .....	2
TILTING.....	2
ENVIRONMENTAL RATING .....	2
MACHINE GROUNDING AND HIGH FREQUENCY INTERFERENCE PROTECTION.....	2
INPUT CONNECTIONS .....	3
INPUT RECONNECT PROCEDURE .....	3
OUTPUT CONNECTIONS .....	4
CONNECTIONS FOR TIG (GTAW) WELDING.....	4
TIG TORCH CONNECTION .....	4
WORK CABLE CONNECTION.....	4
SHIELDING GAS CONNECTION .....	4
REMOTE CONTROL CONNECTION.....	5
CONNECTIONS FOR STICK (SMAW) WELDING .....	5
STICK ELECTRODE CABLE AND WORK CABLE CONNECTION .....	5
<b>OPERATION SECTION.....</b>	<b>6</b>
SAFETY PRECAUTIONS.....	6
GENERAL DESCRIPTION .....	6
INCLUDED EQUIPMENT .....	6
FOR GTAW (TIG WELDING):.....	6
FOR SMAW (STICK WELDING): .....	6
FOR INSTALLATION AND STARTUP: .....	6
WELDING CAPABILITY .....	6
CONTROLS AND SETTINGS .....	7
OPERATING STEPS .....	8
WELDING IN TIG MODE (2-STEP).....	8
WELDING IN TIG MODE (4-STEP).....	8
REMOTE CONTROL OPERATION.....	9
BENEFITS OF THE SQUARE WAVE DESIGN .....	9
WELDING IN STICK MODE .....	10
<b>ACCESSORIES SECTION.....</b>	<b>11</b>
<b>MAINTENANCE SECTION .....</b>	<b>12</b>
<b>TROUBLESHOOTING SECTION.....</b>	<b>13</b>
<b>DIAGRAM SECTION .....</b>	<b>20</b>
WIRING DIAGRAM.....	20
DIMENSION PRINT.....	21
<b>PARTS LISTS .....</b>	<b>P281 SERIES, P210-F, P66-J</b>

## TECHNICAL SPECIFICATIONS - Square Wave TIG 175 (K1583-1 only)

INPUT - SINGLE PHASE ONLY		
<b>Standard Voltage</b> 240/380/415/1/50/60 Additional Lincoln Rating 220-240/400-415/1/50/60	<b>Input Current at Rated Output</b> 54/33/30 AC/DC Stick & DC TIG, 71/41/37 AC TIG 54/30 AC/DC Stick & DC TIG, 71/37 AC TIG	<b>Code Number</b> 10457
RATED OUTPUT		
<b>Duty Cycle</b> GTAW 25% Duty Cycle 40% Duty Cycle 60% Duty Cycle 100% Duty Cycle  SMAW 25% Duty Cycle 40% Duty Cycle 60% Duty Cycle 100% Duty Cycle	<b>Amps</b> 150 125 110 85  150 125 110 85	<b>Volts at Rated Amperes</b> 16.0 V AC/DC 15.0 V AC/DC 14.4 V AC/DC 13.4 V AC/DC  26.0 V AC/DC 25.0 V AC/DC 24.4 V AC/DC 23.4 V AC/DC
OUTPUT		
<b>Output Current Range</b> 10-175 Amps AC and DC	<b>Maximum Open Circuit Voltage</b> (STICK AND TIG) AC OCV: 78 DC OCV: 64	<b>Type of Output</b> CC (Constant Current) AC/DC

RECOMMENDED INPUT WIRE AND FUSE SIZES <sup>(1)</sup>								
For AC/DC Stick and DC TIG Welding at 150A/25% Duty Cycle and for AC TIG Welding up to 110A/25% Duty Cycle. Based on the 1996 U.S. National Electrical Code					For AC TIG Welding at 150 A/25% Duty Cycle, Based on the 1996 U.S. National Electrical Code			
Input Voltage / phase/ Frequency	Fuse (Super Lag) or Breaker Size	Input Ampere Rating on Nameplate	Type 75°C Copper Wire in Conduit AWG (IEC) Sizes	Type 75°C Copper Ground Wire in Conduit AWG (IEC) Sizes	Fuse (Super Lag) or Breaker Size	Input Ampere Rating on Nameplate	Type 75°C Copper Wire in Conduit AWG (IEC) Sizes	Type 75°C Copper Ground Wire in Conduit AWG (IEC) Sizes
240/1/50	100	54	10 (5.2 mm <sup>2</sup> )	10 (5.2 mm <sup>2</sup> )	125	71	8 (8.2 mm <sup>2</sup> )	8 (8.2 mm <sup>2</sup> )
380/1/50	60	33	14 (2.1 mm <sup>2</sup> )	14 (2.1 mm <sup>2</sup> )	80	41	12 (3.3 mm <sup>2</sup> )	12 (3.3 mm <sup>2</sup> )
415/1/50	60	30	14 (2.1 mm <sup>2</sup> )	14 (2.1 mm <sup>2</sup> )	70	37	12 (3.3 mm <sup>2</sup> )	12 (3.3 mm <sup>2</sup> )
220/1/50	100	54	10 (5.2 mm <sup>2</sup> )	10 (5.2 mm <sup>2</sup> )	125	67	8 (8.2 mm <sup>2</sup> )	8 (8.2 mm <sup>2</sup> )
400/1/50	60	30	14 (2.1 mm <sup>2</sup> )	14 (2.1 mm <sup>2</sup> )	70	37	12 (3.3 mm <sup>2</sup> )	12 (3.3 mm <sup>2</sup> )

<sup>(1)</sup> The National Electrical Code permits operation at rated output and duty cycle from a 50 amp receptacle when supply lines and fuses are sized per this table.

PHYSICAL DIMENSIONS				
	Height	Width	Depth	Weight
Power Source	19.53 in. 496 mm	13.72 in. 349 mm	24.94 in. 633 mm	Approx. 200 lbs. 90.9 kgs.
Power Source on Undercarriage	27.93 in. 709 mm	19.22 in. 488 mm	36.74 in. 933 mm	Approx. 230 lbs. 105 kgs.

### SQUARE WAVE TIG 175





Read entire installation section before starting installation.

## Safety Precautions

### ⚠ WARNING



#### **ELECTRIC SHOCK can kill.**

- Only qualified personnel should perform this installation.
- Turn the input power OFF at the disconnect switch or fuse box before working on this equipment.
- Do not touch electrically hot parts.
- Always connect the Square Wave TIG 175 to a power supply grounded per the National Electrical Code and any local codes.

## SELECT SUITABLE LOCATION

Place the welder where clean cooling air can freely circulate in through the rear louvers and out through the front and side louvers. Dirt, dust or any foreign material that can be drawn into the welder should be kept at a minimum. Failure to observe these precautions can result in excessive operating temperatures and nuisance shut-downs.

## STACKING

Square Wave TIG 175's cannot be stacked.

## LIFTING AND MOVING

The Square Wave TIG 175 should be lifted by two or more people or with a hoist. (It weighs approximately 200 lbs./90.9 kg.) Its lifting handles are designed to make lifting more convenient. An optional undercarriage is available to easily move the unit. Refer to the Accessories section of this manual.

## TILTING

Each machine must be placed on a secure, level surface, either directly or on a recommended undercarriage. The machine may topple over if this procedure is not followed.

## ENVIRONMENTAL RATING

The Square Wave TIG 175 power source carries an IP21 environmental rating. It may be used in normal industrial and commercial environments. Avoid using it in environments which have falling water such as rain. Read and follow "Electric Shock Warnings" in the Safety section if welding must be performed under electrically hazardous conditions such as welding in wet areas or on or in the workpiece.

## MACHINE GROUNDING AND HIGH FREQUENCY INTERFERENCE PROTECTION

The welder must be grounded. See your local and national electrical codes for proper grounding methods.

The high frequency generator, being similar to a radio transmitter, can be blamed for radio, TV and electronic equipment interference problems. These problems may be the result of radiated interference. Proper grounding methods can reduce or eliminate radiated interference.

Radiated interference can develop in the following four ways:

1. Direct interference radiated from the welder.
2. Direct interference radiated from the welding leads.
3. Direct interference radiated from feedback into the power lines.
4. Interference from re-radiation of "pickup" by ungrounded metallic objects.

Keeping these contributing factors in mind, installing equipment per the following instructions should minimize problems.

1. Keep the welder power supply lines as short as possible and enclose as much of them as possible in rigid metallic conduit or equivalent shielding for a distance of 50 feet (15.2m). There should be good electrical contact between this conduit and the welder case ground. Both ends of the conduit should be connected to a driven ground and the entire length should be continuous.
2. Keep the work and electrode leads as short as possible and as close together as possible. Lengths should not exceed 25 ft (7.6m). Tape the leads together when practical.
3. Be sure the torch and work cable rubber coverings are free of cuts and cracks that allow high frequency leakage.
4. Keep the torch in good repair and all connections tight to reduce high frequency leakage.
5. The work piece must be connected to an earth ground close to the work clamp, using one of the following methods:
  - a) A metal underground water pipe in direct contact with the earth for ten feet or more.

## SQUARE WAVE TIG 175



- b) A 3/4" (19mm) galvanized pipe or a 5/8" (16mm) solid galvanized iron, steel or copper rod driven at least eight feet into the ground.

The ground should be securely made and the grounding cable should be as short as possible using cable of the same size as the work cable, or larger. Grounding to the building frame electrical conduit or a long pipe system can result in re-radiation, effectively making these members radiating antennas.

6. Keep cover and all screws securely in place.
7. Electrical conductors within 50 ft (15.2m) of the welder should be enclosed in grounded rigid metallic conduit or equivalent shielding, wherever possible. Flexible metallic conduit is generally not suitable.
8. When the welder is enclosed in a metal building, the metal building should be connected to several good earth driven electrical grounds (as in 5 (b) above) around the periphery of the building.

Failure to observe these recommended installation procedures can cause radio or TV and electronic equipment interference problems and result in unsatisfactory welding performance resulting from lost high frequency power.

## INPUT SUPPLY CONNECTIONS

Be sure the voltage, phase, and frequency of the input power is as specified on the rating plate, located on the rear of the machine.

1. Connect terminal marked  $\text{⏚}$  to earth ground per National Electric Code or any local codes.
2. Connect the supply lines  $\text{⏚}$  the line switch terminals as shown in figure A.1.
3. Install in accordance with all local and national electrical codes.

The Square Wave TIG is supplied with one cord connector. The cord connector provides a strain relief for the input power cord as it passes through the rear access hole. The cord connector is designed for a cord diameter of 11.4 to 18.0mm (.450 to .704 in.). Remove the plastic compression nut from the cord connector and place it on the cord. (Note: If you are connecting the machine for 220-240V operation you will have to obtain a different cord connector. The new connector should fit the existing knock out which is 33mm (1.3 in.) in diameter. Strip away outer jacket of cord, trim fillers and insert conductors through cord connector. The jacketed portion of the cord must go through the cord connector. Slide the plastic compression nut up the cord to the connector and turn it until it tightens on the input cord.

Refer to the **Technical Specifications** page at the beginning of this section. Fuse the input circuit with the recommended

super lag fuses or delay type<sup>1</sup> circuit breakers. Using fuses or circuit breakers smaller than recommended may result in "nuisance" shut-offs from welder inrush currents even if not welding at high currents.

<sup>1</sup>Also called "inverse time" or "thermal/magnetic" circuit breakers; circuit breakers which have a delay in tripping action that decreases as the magnitude of the current increases.

## INPUT RECONNECT PROCEDURE

On multiple input voltage welders, be sure the machine is connected per the following instructions for the voltage being supplied to the welder.

### ⚠ CAUTION

Failure to follow these instructions can cause immediate failure of components within the welder.

Multiple voltage models are shipped connected for the highest voltage. To change this connection refer to the following instructions.

### ⚠ WARNING



#### ELECTRIC SHOCK can kill.

- Turn the input power OFF at the disconnect switch or fuse box before working on this equipment.

**For 220-240V connection** (Refer to figure A.1 and INPUT SUPPLY CONNECTIONS. A different cord connector must be obtained when connecting to this voltage):

1. Remove the sheet metal cover.
2. Disconnect the copper link between the switch stud and H4.
3. Connect the copper link from the switch stud to H2 and tighten nuts securely.
4. Replace sheet metal cover and all screws.

**For 380V connection** (Refer to figure A.1):

1. Remove the sheet metal cover.
2. Disconnect the copper link between the switch stud and H4.
3. Connect the copper link from the switch stud to H3 and tighten nuts securely.
4. Replace sheet metal cover and all screws.

**For 400-415V connection** (Refer to figure A.1):

1. Remove the sheet metal cover.
2. Disconnect the copper link between the switch stud and H2 or H3.
3. Connect the copper link from the switch stud to H4 and tighten nuts securely.
4. Replace sheet metal cover and all screws.

## SQUARE WAVE TIG 175



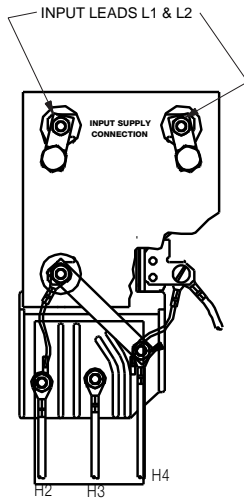

FOR 220-240V: CONNECT COPPER LINK TO H2 -  
(SEE INPUT SUPPLY CONNECTION SECTION)  
FOR 380V: CONNECT COPPER LINK TO H3  
FOR 400-415V: CONNECT COPPER LINK TO H4 (AS SHOWN)

FIGURE A.1 Reconnect Leads

## OUTPUT CONNECTIONS

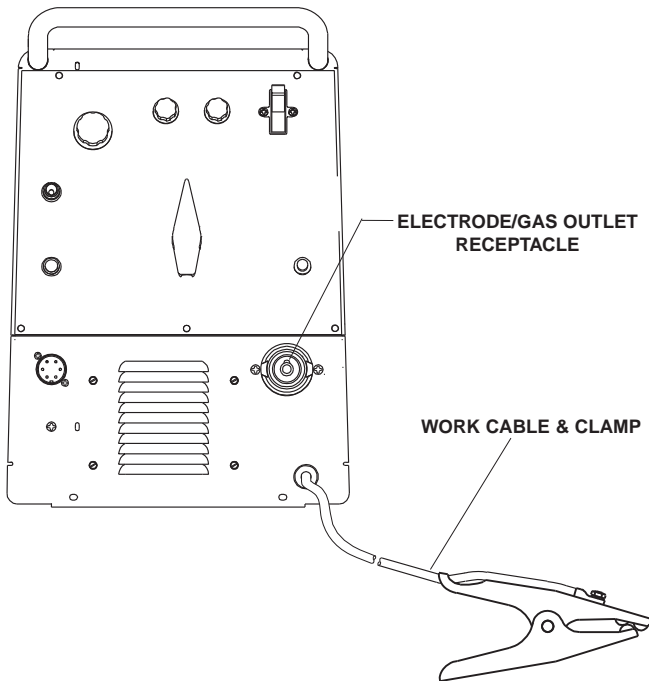

FIGURE A.2 Location of Output Connections

## CONNECTIONS FOR TIG (GTAW) WELDING

### TIG TORCH CONNECTION

The Square Wave TIG 175 is supplied with a Twistmate receptacle which combines the Electrode and Gas connections. Use a LA-9, LA-17 (See OPTIONAL ACCESSORIES section), or any equivalent TIG torch with a right hand male 3/8-24UNF-2B fitting. An adapter and protective boot are included to connect torches with the specified fittings. Slide the rubber

strain relief boot onto the torch and connect the fitting to the adapter. The rubber strain relief boot slips over the connection and adapter block to provide shock protection.

### ⚠ WARNING

To avoid receiving a high frequency shock, keep the TIG torch and cables in good condition.

### WORK CABLE CONNECTION

A work cable with attached work clamp is factory connected to the Square Wave TIG 175. To minimize high frequency interference, refer to **Machine Grounding and High Frequency Interference Protection** section of this manual for the proper procedure on grounding the work clamp and work piece.

### SHIELDING GAS CONNECTION

Obtain the necessary inert shielding gas (usually argon). Connect a cylinder of gas with a pressure regulator and flow gage. Install a gas hose between the regulator and gas inlet (located on the rear of the welder). The gas inlet has a 5/8-18 right hand female thread; CGA #032.

### ⚠ WARNING

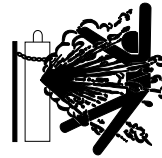

**CYLINDER could explode if damaged.**

- Keep cylinder upright and chained to a support.

- Keep cylinder away from areas where it could be damaged.

- Never allow the torch to touch the cylinder.

- Keep cylinder away from live electrical circuits.

- Maximum inlet pressure 150 psi.

The optional undercarriage features a pivoting platform that simplifies loading and unloading of gas cylinders. A cylinder is loaded by leaning it slightly sideways and rolling it toward the platform. The cylinder's weight will push the platform downward against the floor, forming a ramp. At this point, the cylinder may be rolled up the platform into its final position. **Secure the cylinder in place with the provided chain.** Unload by following these steps in reverse.

## SQUARE WAVE TIG 175



## REMOTE CONTROL CONNECTION

A remote control receptacle is provided on the case front of the welder for connecting a remote control to the machine. Refer to the Optional Accessories section of this manual for other available remote controls.

## CONNECTIONS FOR STICK (SMAW) WELDING

### STICK ELECTRODE CABLE AND WORK CABLE CONNECTION

Refer to *Included Equipment* in the Operation Section of this manual for STICK welding equipment which is included with the Square Wave TIG 175.

An electrode holder with cable is supplied with the Square Wave TIG 175. Turn the Power Switch "OFF". Connect the Twistmate plug into the Electrode/Gas Output Receptacle and turn it clockwise until it is tight. The work cable and work clamp are factory connected.

SQUARE WAVE TIG 175



## SAFETY PRECAUTIONS

Read and understand this entire section before operating the machine.

### WARNING



#### **ELECTRIC SHOCK can kill.**

- Do not touch electrically live parts or electrode with skin or wet clothing.
- Insulate yourself from work and ground.
- Always wear dry insulating gloves.
- Read and follow “Electric Shock Warnings” in the Safety section if welding must be performed under electrically hazardous conditions such as welding in wet areas or on or in the workpiece.



#### **FUMES AND GASES can be dangerous.**

- Keep your head out of fumes.
- Use ventilation or exhaust to remove fumes from breathing zone.

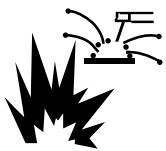

#### **WELDING SPARKS can cause fire or explosion**

- Keep flammable material away.
- Do not weld on containers that have held combustibles.



#### **ARC RAYS can burn.**

- Wear eye, ear and body protection.

Observe additional Safety Guidelines detailed in the beginning of this manual.

## GENERAL DESCRIPTION

The Square Wave TIG 175 is a constant current, single range AC/DC TIG (GTAW) arc welding power source with built-in arc starter / stabilizer. It also has stick welding (SMAW) capability.

The Square Wave TIG 175 is recommended for the TIG (GTAW) and stick (SMAW) welding processes within its output capacity of 10 to 175 amps, on both AC and DC polarity.

## INCLUDED EQUIPMENT

#### **For GTAW (TIG Welding):**

- TIG connector (Twistmate adaptor)
- Strain relief boot

#### **For SMAW (Stick Welding):**

- Electrode holder with cable and Twistmate plug

#### **For Installation and startup:**

- Work Cable and Clamp

## WELDING CAPABILITY

The Square Wave TIG 175 is rated at 150 amps, 16 volts, at 25% duty cycle on a ten minute basis. It is capable of higher duty cycles at lower output currents. It is capable of 175 amps, 27 volts at a lower duty cycle. If the duty cycle is exceeded, a thermal protector will shut off the output until the machine cools.

## SQUARE WAVE TIG 175







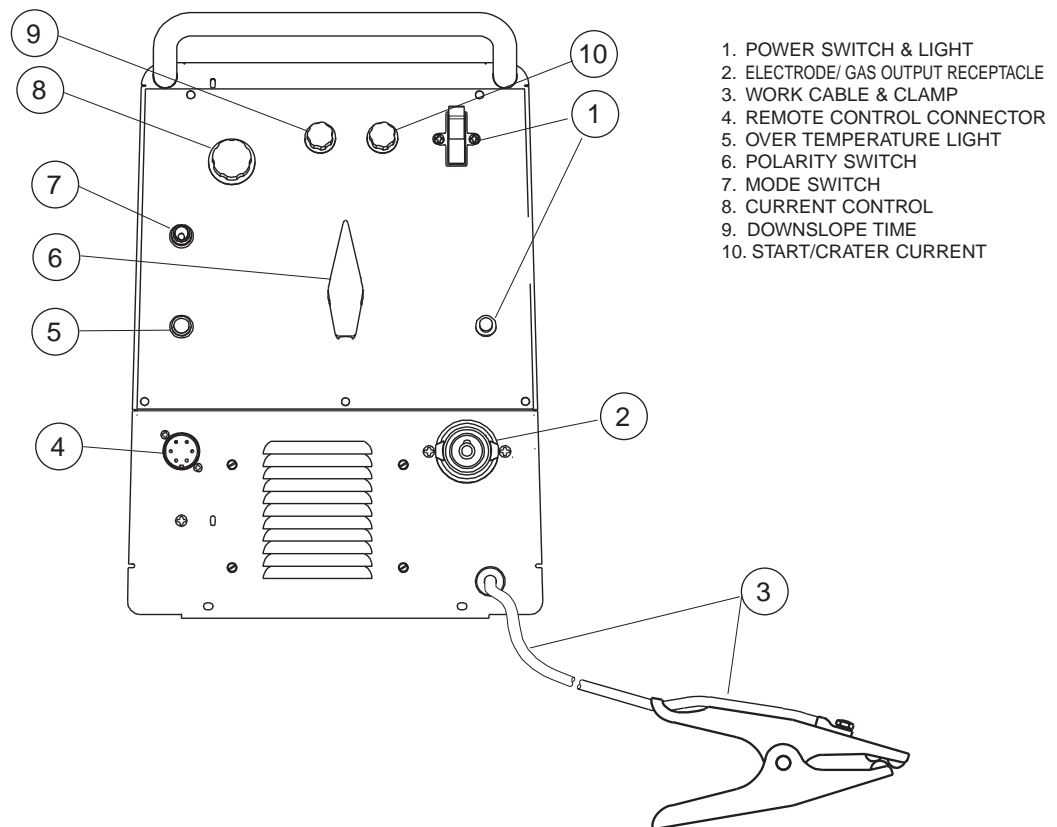

## CONTROLS AND SETTINGS

All operator controls and adjustments are located on the front of the Square Wave TIG 175. Refer to Figure B.1 and corresponding explanations.

FIGURE B.1 - CONTROL PANEL



1. POWER SWITCH & LIGHT
2. ELECTRODE/ GAS OUTPUT RECEPTACLE
3. WORK CABLE & CLAMP
4. REMOTE CONTROL CONNECTOR
5. OVER TEMPERATURE LIGHT
6. POLARITY SWITCH
7. MODE SWITCH
8. CURRENT CONTROL
9. DOWNSLOPE TIME
10. START/CRATER CURRENT

1. **POWER SWITCH & LIGHT** - Turns power on  or off  the welder. When switched "ON", the cooling fan runs and the white light will illuminate indicating that the power is on.
2. **ELECTRODE/GAS OUTPUT RECEPTACLE** - This Twistmate receptacle provides the electrical connection to the electrode holder and cable for Stick welding and a combined electrical and gas connection for the TIG torch when TIG welding.
3. **WORK CABLE** - This work cable is factory connected to the welder and is connected to the work piece to complete the welding circuit. Refer to **Machine Grounding and High Frequency Interference Protection** in the Installation section of this manual for the proper procedure on grounding the work clamp and work piece to minimize high frequency interference.
4. **REMOTE CONTROL CONNECTOR** - This connector provides connection for a remote control. See **Remote Control Operation** in this section of the manual.
5. **OVER TEMPERATURE LIGHT** -  If the welder overheats due to blocked air flow, high ambient air temperature, or exceeded duty cycle, an internal thermostat will open disabling the welding output and this yellow light will illuminate. The cooling fans will continue to run to cool the unit during this time. The light will go out when the unit cools and the thermostat resets.
6. **POLARITY SWITCH** - Allows you to select between welding in AC  , DC -  , or DC+  polarity. In DC + polarity the electrode is positive and the work clamp is negative. Use DC + for most stick welding. In DC - the electrode is negative and the work clamp is positive. Use DC - for TIG welding stainless steel and mild steel. AC polarity is recommended for TIG welding aluminum.

### CAUTION



Do not switch the polarity switch while welding or damage may result to the machine.

SQUARE WAVE TIG 175







**7. MODE SWITCH** - A three position toggle switch used to select the welding mode. Refer to WELDING IN THE STICK MODE, and WELDING IN THE TIG MODE(2-STEP AND 4-STEP) later in this section for information on how the machine functions in each of these modes.

 **STICK:** This mode is used for the stick electrode (SMAW) welding process. In this position the only active control is the output current control. The output terminals are continuously energized.

 **2-STEP TIG:** This mode is used for the TIG (GTAW) welding process. An Arc Start switch or Amptrol must be used to weld. The Down slope Time and Start/Crater Current controls have no effect in this mode.

 **4-STEP TIG:** This mode is used for the TIG (GTAW) welding process. An Arc Start switch or Amptrol must be used. All controls are active in this mode.

**8. CURRENT CONTROL** - This control is active in both TIG and Stick modes. In Stick mode the current control sets the welding current. In TIG mode this control sets the maximum current. The Amptrol™ will adjust the welding current from the machine minimum to this maximum setting.

 **9. DOWN SLOPE TIME** - This control is active in the 4-STEP TIG mode only. It is used to set the amount of time the output takes to go from the preset level to the Crater current level. The adjustable range is approximately 0.5 to 10 seconds.

 **10. START/CRATER CURRENT** - This control is active in the 4-STEP TIG mode only. It sets the Start and Crater currents of the weld as a percentage of the peak current set with the Current control knob. If the Start current set is not above the minimum starting current of the machine or electrode the weld will not start. If this occurs increase the percentage and try again.

## OPERATING STEPS

### WELDING IN TIG MODE (2 STEP)

In 2-STEP mode an Arc Start switch or Amptrol must be used. The switch or Amptrol is pressed to start the weld. (Step 1) Output continues at the level set with the Current control until the switch or Amptrol is released. (Step 2)

1. If connecting a Lincoln LA-9 or LA-17 TIG torch simply connect the Twistmate plug to the receptacle located on the front of the machine. See INPUT SUPPLY CONNECTIONS if another TIG torch is used.
2. Set the MODE switch to "2 STEP TIG".

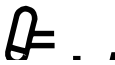
3. Set the Polarity Switch to DC- for welding steel or stainless steel; or to AC for welding aluminum. 

4. Connect an Arc Start Switch or Amptrol to the Remote Control Connector.

5. Turn on the cylinder gas valve and adjust the flow regulator to obtain desired flow.

6. Turn the power switch to "ON - I". NOTE: There will be a 15 second gas flow when the power is turned on.

7. Set the Current Control on the control panel to the maximum desired amps.

8. Depress the Arc Start Switch or ampctrl to energize the torch and establish an an arc with the work piece.

**NOTE:** When the MODE switch is set to "2 STEP TIG",  depressing the remote control will start a 0.5 second gas pre-flow before energizing the TIG torch. When the remote control is released the TIG torch is de-energized and gas flow will continue for a 15 second post flow. When the polarity switch is set to DC, the TIG Arc Starter will turn on and off automatically to start and stabilize the arc. In AC the TIG Arc Starter will turn on with the output and remain on continuously until the remote control is released.

### WELDING IN TIG MODE (4-STEP)

In 4-STEP mode an Arc Start switch or Amptrol must be used. The switch or Amptrol is pressed and then released to start the weld cycle. Pressing and releasing the switch or Amptrol a second time ends the weld cycle. This eliminates the need to continuously hold down the switch or Amptrol during the weld. The process works as follows:

**(STEP 1) First Press:** Initiates a 0.5 second preflow of shielding gas and starts the weld at the Start current level set with the Start/Crater Current control. (Note: The Start current is determined by setting a peak current with the output control knob and then setting a percentage of that current with the Start/Crater Current control. IMPORTANT! THE WELD WILL NOT START IF THE START CURRENT IS SET BELOW THE MACHINES MINIMUM WELDING CURRENT. (Approx 10 Amps))



**(STEP 2) First Release:** The output ramps up to the preset level in 0.5 seconds.

## SQUARE WAVE TIG 175



**(STEP 3) Second Press:** The output ramps down to the level set with the Start/Crater Current control. The time it takes to ramp down is set with the Down slope Time control. (Approx. 0.5 to 10 seconds)

**(STEP 4) Second Release:** Output is turned off stopping the weld and a 15 second Postflow of shielding gas is applied.

1. If connecting a Lincoln LA-9 or LA-17 TIG torch connect the Twistmate plug to the receptacle located on the front of the machine. See INPUT SUPPLY CONNECTIONS if another TIG torch is used.
2. Set the MODE switch to "4-STEP TIG" 
3. Set the Polarity Switch to DC- for welding steel or stainless steel; or to AC for welding aluminum.
4. Connect an Arc Start switch or Amptrol to the Remote Control Connector.
5. Turn on the cylinder gas valve and adjust the flow regulator to obtain the desired flow.
6. Turn the power switch to "ON - I". NOTE: There will be a 15 second gas flow when the power is turned on.
7. Set the Current Control on the control panel to the maximum desired amps.
8. Set the Start/Crater Current control  on the control panel to obtain the desired level as a percentage of the maximum current. Note: The level set must be above the machines minimum starting level. (12 Amps)
9. Set the Down slope Time control  on the control panel to the desired level.
10. Depress the Arc Start switch or Amptrol to energize the torch and establish an arc at the Start current level with the work piece.
11. Release the Arc Start switch or Amptrol to ramp up to the maximum current setting.
12. Depress the Arc Start switch or Amptrol again to start the Down slope time.
13. Release the Arc Start switch or Amptrol to stop welding.

**NOTE:** When the polarity switch is set to DC, the TIG Arc Starter will turn on and off automatically to start and stabilize the arc. In AC the TIG Arc Starter will turn

on with the output and remain on continuously until the remote control is released.

## REMOTE CONTROL OPERATION

A Foot Amptrol™ is included with the Square Wave TIG 175 for remote current control while TIG welding. An optional Hand Amptrol may also be used. An optional Arc Start Switch may be used to start and stop the welding if no remote control of the current is desired. Refer to the Accessories section of this manual.

Both the Hand and Foot Amptrol work in a similar manner. For simplicity, the following explanation will refer only to "Amptrols", meaning both Foot and Hand models. The term "minimum" refers to a foot pedal in the "up" position, as it would be with no foot pressure, or a Hand Amptrol in the relaxed position, with no thumb pressure. "Maximum" refers to a fully depressed Foot Amptrol, or a fully extended Hand Amptrol.

When the welder is in 2 Step TIG mode activating the Amptrol energizes the electrode terminal and varies the output welding current from its minimum value of 10 amps, to the maximum value set by the Current Control on the control panel. This helps eliminate accidental high current damage to the work piece and/or tungsten, and gives a fine control of the current. When the welder is in 4 Step TIG mode the Amptrol acts as an Arc Start Switch. When the welder is in the stick mode a remote control has no effect and is not used.

It is important to note that, in some cases, the tungsten will not start an arc at the minimum current because the tungsten may be too large or cold. To start an arc reliably, it is important to depress the Amptrol far enough so that the machine output current is near the tungsten operating range. For example, a 3/32" tungsten may be used on DC- to weld the full range. To start the weld, the operator may have to turn the current control up and depress the Amptrol approximately 1/4 of the way down. Depressing the Amptrol to its minimum position may not start the arc. Also if the Current Control or Start/Crater current is set too low, the arc may not start. In most cases, a large or cold tungsten will not readily establish an arc at low currents. This is normal. In DC-, the Square Wave 175 will start a 3/32, 2% thoriated tungsten electrode at 15 amperes provided the electrode tip is properly grounded and not contaminated.

## BENEFITS OF THE SQUARE WAVE DESIGN

In AC TIG welding of aluminum, the positive portion of the AC wave provides *cleaning* (removal of aluminum oxide) of the work piece. This is desirable on materials with a heavy oxide coating such as aluminum. However

## SQUARE WAVE TIG 175



the positive portion may also cause the electrode to overheat at high currents causing “tungsten spitting”. The negative portion of the AC wave offers no cleaning action but concentrates more heat on the work. The AC waveform of the Square Wave TIG 175 optimizes cleaning and heating of the work. The result is the capability to weld through the complete range of 12 to 175 amperes in AC TIG or DC- TIG requiring only one electrode, a 3/32” 2% thoriated tungsten.

**WELDING IN STICK MODE**

1. Put the electrode holder and cable quick connect plug into the electrode output receptacle. Turn clockwise until tight. Connect the work clamp to the work piece.
2. Set the TIG/STICK switch to “STICK”.
3. Set the Polarity Switch for the type of electrode being used (most commonly DC+).

**⚠ WARNING**



In Stick Mode the output terminal and electrode will be electrically hot whenever the power switch is turned on.

4. Place the electrode in the electrode holder.
5. Turn the power switch to “ON”.
6. Adjust the Current Control to the desired amps.
7. Strike an arc and weld.

NOTE: When the TIG/STICK switch is set to “STICK” the output is always on when the power switch is on. A remote control has no effect on the welding current and the gas flow and high frequency TIG arc starter are disabled.

**RECOMMENDED ELECTRODE AMPERAGE RANGES - SQUARE WAVE TIG 175**

The Square Wave TIG 175 is rated from 10 - 175 Amps.

**SMAW Process**

ELECTRODE	POLARITY	3/32"	1/8"	5/32"
Fleetweld 5P, Fleetweld 5P+	DC+	40 - 70	75 - 130	90 - 175
Fleetweld 180	DC+	40 - 80	55 - 110	105 - 135
Fleetweld 37	DC+	70 - 95	100 - 135	145 - Max
Fleetweld 47	DC-	75 - 95	100 - 145	135 - Max
Jet-LH MR	DC+	85 - 110	110 - 160	130 - Max
Blue Max Stainless	DC+	40 - 80	75 - 110	95 - 110
Red Baron Stainless	DC+	40 - 70	60 - 100	90 - 140

Mild steel procedures are based on recommended procedures listed in C2.10 8/94 and the maximum rating of the Square Wave TIG 175  
 Jet-LH MR procedures are based on Jet-LH 78 MR  
 Blue Max procedures are based on C6.1 6/95  
 Red Baron Procedure are based on ES-503 10/93

**GTAW Process**

Electrode Polarity		DC-		AC		Approximate Argon Gas Flow Rate C.F.H. (l/min.)	
Electrode Tip Preparation		Sharpened		Balled			
Electrode Type		EWTh-1, EWCe-2 EWTh-2, EWLa-1 EWG		EWP	EWZr EWTh-1, EWTh-2 EWCe-2, EWLa-1 EWG	Aluminum	Stainless Steel
Electrode Size (in.)							
.010		Up to 15 A.	Up to 10 A.	Up to 15 A.	3-8 (2-4)	3-8 (2-4)	
.020		Up to 15 A.	Up to 15 A.	Up to 20 A.	5-10 (3-5)	5-10 (3-5)	
.040		Up to 80 A.	Up to 40 A.	Up to 60 A.	5-10 (3-5)	5-10 (3-5)	
1/16		Up to 150 A.	Up to 100 A.	Up to 130 A.	5-10 (3-5)	9-13 (4-6)	
3/32		Up to MAX. A.	Up to 160 A.	Up to MAX. A.	13-17 (6-8)	11-15 (5-7)	
1/8	X		Up to MAX. A.	X	15-23 (7-11)	11-15 (5-7)	

Tungsten electrodes are classified as follows by the American Welding Society (AWS):

- Pure .....EWP .....green
- +1% Thoria .....EWTh-1 ...yellow
- +2% Thoria .....EWTh-2...red
- +2% Ceria.....EWCe-2...orange
- +1.5% Lanthana .....EWLa-1 ...black
- +0.15 to 0.40% Zirconia ...EWZr .....brown

Ceriated Tungsten is now widely accepted as a substitute for 2% Thoriated Tungsten in AC and DC applications.

**SQUARE WAVE TIG 175**



## OPTIONAL ACCESSORIES

**K964-1 Undercarriage with Pivoting Single Gas Cylinder Platform** - This undercarriage features a pivoting platform to easily load and unload the gas cylinder without lifting. It was designed specifically for the Square Wave TIG 175 power source, and accommodates 7" to 9 1/4" diameter gas cylinders. The undercarriage comes completely assembled and mounts directly to the power source.

**K870 Foot Amptrol™** - A foot operated remote current control to be used while welding in 2 Step TIG mode. In 4 Step TIG mode the Foot Amptrol acts as an Arc Start Switch.

**K812 Hand Amptrol™** - A thumb operated remote current control to be used while welding in 2 Step TIG mode. In 4 Step TIG mode the Hand Amptrol acts as an Arc Start Switch.

**K814 Arc Start Switch** - The Arc Start Switch does not provide remote current control. In 2 Step TIG mode the Arc Start Switch allows on/off welding at the current set with the Current Control on the control panel. The Start/Crater Current and Downslope Time controls are only active in 4 Step mode.

**Magnum® LA-9 and LA-17 TIG Torches** - The following standard Magnum® TIG torches with one-piece cable may be used with the Square Wave TIG 175.

- K859-1 LA-9 12.5 ft medium back cap
- K859-5 LA-9 25 ft medium back cap
- K860-1 LA-17 12.5 ft long back cap
- K860-5 LA-17 25 ft long back cap

**NOTE:** Each torch requires a Twistmate plug (S22529-1) and strain relief boot (M17255) be installed onto the cable. Collets, collet bodies, and nozzles are not included and must be ordered separately.

**Twistmate® Plug (S22529-1) and Strain Relief Boot (M17255)** - One of each is shipped with the welder to connect any TIG torch with a right hand male 3/8-24UNF-2B fitting. The Magnum LA-9 and LA-17 Torches are recommended. If you do not care to interchange these parts when using more than one torch you may order additional sets. The Twistmate plug provides connection for both gas and welding current.

**Tungstens, Collets, Collet Holders, Gas Cups, Backcaps and Other Torch Parts** - Standard Magnum® parts and accessories for this torch may be used when using a Magnum LA-9 or LA-17.

**TIG Torch Parts Kits** - Parts kits are available for the LA-9 and LA-17 TIG torches. These kits include back cap, collets, collet bodies, nozzles and tungstens.

**Order KP507** for LA-9 torches

**Order KP508** for LA-17 torches

See publication E12.150 for parts kits breakdown.

**Cut Length Consumables** - TIG welding filler metals are available for welding stainless steel, mild steel, aluminum and copper alloys. See publication C9.10.

## SAFETY PRECAUTIONS

### ⚠ WARNING



**ELECTRIC SHOCK can kill.**

- Only qualified personnel should perform this maintenance.
- Turn the input power **OFF** at the disconnect switch or fuse box before working on this equipment.
- Do not touch electrically hot parts.

### ⚠ WARNING

To avoid receiving a high frequency shock, keep the TIG torch and cables in good condition.

## ROUTINE AND PERIODIC MAINTENANCE

1. Disconnect power supply lines to machine before performing periodic maintenance.
2. Periodically clean the inside of the machine with a low pressure air system. Be sure to clean the following components thoroughly.
  - Main Transformer
  - Electrode/Gas Output Receptacle
  - Polarity Switch
  - Rectifier Assembly
  - Arc Starter/Spark Gap Assembly
  - PC Boards
  - Fan Blades
3. Inspect welder output and control cables for fraying, cuts, and bare spots.
4. Keep TIG torch and cables in good condition.
5. Clean air louvers to ensure proper air flow and cooling.
6. The fan motor has sealed ball bearings which require no maintenance.
7. The arc starter spark gap spacing is factory set at 0.015 inch. It typically will not require periodic maintenance. Refinishing the contacts is not recommended.

omended. If the contacts are replaced reset the gap spacing to 0.015. Refer to figure C.1. Note in highly dirty environments where there is an abundance of conductive contaminants, use a low pressure air stream to clean the spark gap. Do not disturb the factory setting.

8. Inspect gas hose and inlet fitting for cracks or leaks.
9. Replace any unreadable labels or decals.
10. Verify that the machine and welding circuit is properly grounded.

**FIGURE C.1 SPARK GAP**

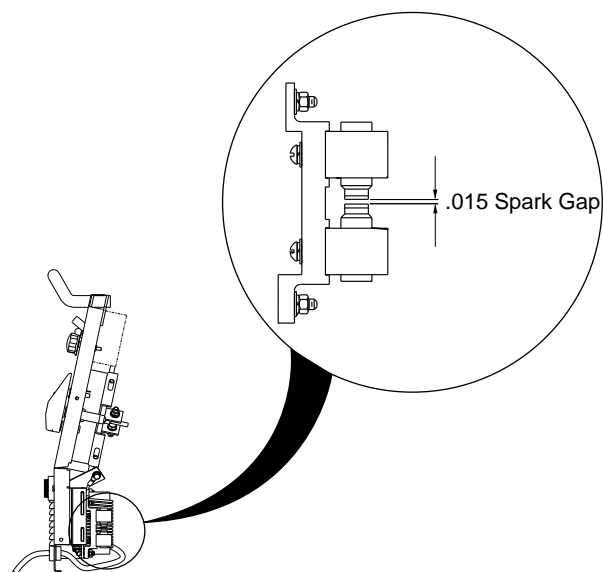

**LEFT SIDE OF MACHINE**

## FAN MOTOR OR FAN BLADE REPLACEMENT

When installing a new fan blade or fan motor be sure to maintain proper shaft spacing per Figure C.2 below.

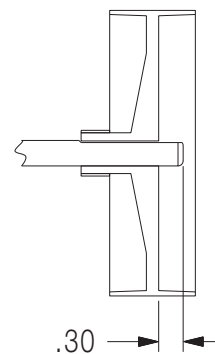

**Figure C.2**

**SQUARE WAVE TIG 175**





## HOW TO USE TROUBLESHOOTING GUIDE

### WARNING

Service and Repair should only be performed by Lincoln Electric Factory Trained Personnel. Unauthorized repairs performed on this equipment may result in danger to the technician and machine operator and will invalidate your factory warranty. For your safety and to avoid Electrical Shock, please observe all safety notes and precautions detailed throughout this manual.

This Troubleshooting Guide is provided to help you locate and repair possible machine malfunctions. Simply follow the three-step procedure listed below.

#### **Step 1. LOCATE PROBLEM (SYMPTOM).**

Look under the column labeled "PROBLEM (SYMPTOMS)". This column describes possible symptoms that the machine may exhibit. Find the listing that best describes the symptom that the machine is exhibiting. Symptoms are grouped into the following categories: output problems, function problems, TIG mode problems, TIG welding problems and Stick welding Problems.

#### **Step 2. PERFORM EXTERNAL TESTS.**

The second column labeled "POSSIBLE AREAS OF MISADJUSTMENT(S)" lists the obvious external possibilities that may contribute to the machine symptom. Perform these tests/checks in the order listed. In general, these tests can be conducted without removing the case wrap-around cover.

#### **Step 3. RECOMMENDED COURSE OF ACTION**

If you have exhausted all of the items in step 2. Contact your Local Lincoln Authorized Field Service Facility.

### CAUTION

**DO NOT** use a volt-ohm meter to measure output voltages in TIG mode. The High Frequency Arc Starter voltage can damage the meter.

### CAUTION

If for any reason you do not understand the test procedures or are unable to perform the tests/repairs safely, contact your **Local Lincoln Authorized Field Service Facility** for technical troubleshooting assistance before you proceed.

SQUARE WAVE TIG 175





Observe all Safety Guidelines detailed throughout this manual

PROBLEMS (SYMPTOMS)	POSSIBLE AREAS OF MISADJUSTMENTS(S)	RECOMMENDED COURSE OF ACTION
<b>OUTPUT PROBLEMS</b>		
Machine is Dead - No Output - No Fan	<ol style="list-style-type: none"> <li>1. Make certain that the input power switch is in the "ON" position and machine is plugged in.</li> <li>2. Check the input voltage at the machine. Input voltage must match the rating plate and voltage connection. Refer to Reconnect Procedure in the Installation section of this manual.</li> <li>3. Blown or missing fuses in input line.</li> </ol>	Contact your <b>Local Lincoln Authorized Field Service Facility</b> for technical troubleshooting assistance.
Output is present No Fan, High Frequency, Lights, or Gas Solenoid	<ol style="list-style-type: none"> <li>1. Check 5A fuse F1 located next to the control PC board on the left side of the machine.</li> </ol>	
Fan runs - No output from machine in either Stick or TIG (2/4 Step) modes.	<ol style="list-style-type: none"> <li>1. Check for proper input voltages per nameplate and voltage reconnection.</li> <li>2. Check to make sure polarity switch is not in between two positions.</li> </ol>	
Fan runs - No output from machine in either Stick or TIG (2/4 Step) modes and the yellow light on the control panel is on.	<ol style="list-style-type: none"> <li>1. Welding application may have exceed the recommended duty cycle. Allow the unit to run until the fan cools the unit and the yellow light goes out.</li> </ol>	
Machine does not respond (no gas flow, no high frequency and no open circuit voltage) when arc start switch or Amptrol is activated - fan is working.	<ol style="list-style-type: none"> <li>1. Machine MUST be in the TIG Mode.</li> <li>2. The Amptrol may be defective. Check for continuity between pins "D" and "E" on cable connector when Amptrol is depressed.</li> </ol>	

**⚠ CAUTION**

If for any reason you do not understand the test procedures or are unable to perform the tests/repairs safely, contact your **Local Lincoln Authorized Field Service Facility** for technical troubleshooting assistance before you proceed.

**SQUARE WAVE TIG 175**



Observe all Safety Guidelines detailed throughout this manual

PROBLEMS (SYMPTOMS)	POSSIBLE AREAS OF MISADJUSTMENTS(S)	RECOMMENDED COURSE OF ACTION
<b>OUTPUT PROBLEMS</b>		
Machine regularly over heats - thermostat opens, Yellow light on front panel glows. The fan runs but machine has no output.	<ol style="list-style-type: none"> <li>1. Welding application may exceed recommended duty cycle. Reduce the duty cycle.</li> <li>2. Dirt and dust may have clogged the cooling channels inside the machine. Blow out unit with clean, dry low pressure air.</li> <li>3. Air intake and exhaust louvers may be blocked due to inadequate clearance around machine.</li> </ol>	Contact your <b>Local Lincoln Authorized Field Service Facility</b> for technical troubleshooting assistance.

 **CAUTION**

If for any reason you do not understand the test procedures or are unable to perform the tests/repairs safely, contact your **Local Lincoln Authorized Field Service Facility** for technical troubleshooting assistance before you proceed.

**SQUARE WAVE TIG 175**



Observe all Safety Guidelines detailed throughout this manual

PROBLEMS (SYMPTOMS)	POSSIBLE AREAS OF MISADJUSTMENTS(S)	RECOMMENDED COURSE OF ACTION
<b>TIG MODE PROBLEMS</b>		
Machine output is intermittently lost. Gas flow and high frequency are also interrupted.	<ol style="list-style-type: none"> <li>1. Problem may be caused by high frequency interference. Make sure that the machine is grounded properly according to the installation instructions. If there are other high frequency sources in the area, make certain that they are grounded properly.</li> <li>2. Check Amptrol for proper operation and loose connections.</li> <li>3. Check for proper input voltage and proper voltage reconnection.</li> </ol>	Contact your <b>Local Lincoln Authorized Field Service Facility</b> for technical troubleshooting assistance.
Arc "Flutters" when TIG welding.	<ol style="list-style-type: none"> <li>1. Tungsten electrode may be too large in diameter for the current setting.</li> <li>2. Tungsten not "sharp" when welding in DC - mode.</li> <li>3. Gas shielding may be insufficient. Increase gas flow; reduce tungsten stickout beyond gas cup.</li> <li>4. Check for contaminated gas or leaks in the gas line, torch, or connections</li> <li>5. If a helium blend is used as a shielding gas, then reduce the percentage of helium.</li> </ol>	
Arc "Pulsates" when AC TIG welding.	Micro Switch mounted on Polarity Switch is not opening in "AC" mode.	

 **CAUTION**

If for any reason you do not understand the test procedures or are unable to perform the tests/repairs safely, contact your **Local Lincoln Authorized Field Service Facility** for technical troubleshooting assistance before you proceed.

**SQUARE WAVE TIG 175**

Observe all Safety Guidelines detailed throughout this manual

PROBLEMS (SYMPTOMS)	POSSIBLE AREAS OF MISADJUSTMENTS(S)	RECOMMENDED COURSE OF ACTION
<b>TIG WELDING PROBLEMS</b>		
Black areas along weld bead.	<ol style="list-style-type: none"> <li>1. Clean any oily or organic contamination from the work piece. When welding aluminum, clean oxide layer with a stainless steel brush.</li> <li>2. Tungsten electrode may be contaminated. Replace or sharpen.</li> <li>3. Check for contaminated gas or leaks in the gas line, torch, or connections</li> <li>4. Gas shielding may be insufficient. Increase gas flow; reduce tungsten stickout beyond gas cup.</li> </ol>	Contact your <b>Local Lincoln Authorized Field Service Facility</b> for technical troubleshooting assistance.
Weak high frequency - machine has normal welding output.	<ol style="list-style-type: none"> <li>1. Check for poor connections in the welding circuit.</li> <li>2. Gas shielding may be insufficient. Increase gas flow; reduce tungsten stickout beyond gas cup.</li> <li>3. Check for work and electrode cables in poor condition allowing high frequency to "Leak Off".</li> <li>4. Keep cables as short as possible.</li> <li>5. Check Spark Gap operation and setting (0.015")</li> </ol>	
High frequency "spark" is present at tungsten electrode, but operator is unable to establish a welding arc. Machine has normal open circuit voltage (refer to <b>Technical Specifications</b> in the Installation Chapter).	<ol style="list-style-type: none"> <li>1. The tungsten electrode may be contaminated. Replace or sharpen.</li> <li>2. The current control may be set too low.</li> <li>3. The tungsten electrode may be too large for the process.</li> <li>4. If a helium blend is used as a shielding gas, then reduce the percentage of helium.</li> <li>5. If in 4 Step TIG mode the Start/Crater current control may be set to low.</li> </ol>	

 **CAUTION**

If for any reason you do not understand the test procedures or are unable to perform the tests/repairs safely, contact your **Local Lincoln Authorized Field Service Facility** for technical troubleshooting assistance before you proceed.

**SQUARE WAVE TIG 175**



Observe all Safety Guidelines detailed throughout this manual

PROBLEMS (SYMPTOMS)	POSSIBLE AREAS OF MISADJUSTMENTS(S)	RECOMMENDED COURSE OF ACTION
<b>TIG WELDING PROBLEMS</b>		
No high frequency. Machine is in either 2 or 4 Step TIG Mode and has normal output. Fan is running and power light is on.	1. If the machine location is in a highly dirty environment with conductive contaminants, check and clean the spark gap with a low pressure air stream per the maintenance instructions.	Contact your <b>Local Lincoln Authorized Field Service Facility</b> for technical troubleshooting assistance.
No gas flow when Amptrol is activated in the 2/4 Step TIG Modes. Machine has output - fan runs. A "Click" can be heard indicating that the gas solenoid valve is operating.	1. Gas supply is empty or not turned on. 2. Flow regulator may be set too low. 3. Gas hose may be pinched. 4. Gas flow may be blocked with dirt. Check filter screen inside gas inlet fitting to solenoid valve. Use filters to prevent recurrence. 5. Consult your local welder/gas distributor.	
When AC TIG welding, the arc is erratic and there is a loss of "cleaning" of the work piece.	1. Tungsten electrode may be too small for process. Use a larger diameter tungsten or a pure tungsten. 2. If a helium blend is used as a shielding gas, then reduce the percentage of helium. 3. Gas shielding may be insufficient. Increase gas flow; reduce tungsten stickout beyond gas cup. Minimize crossdrafts in welding area.	
The end of the tungsten electrode melts away.	1. The welding current is too high for the electrode type and/or size. See the Table B.1 in the Operation Section of this manual.	

**⚠ CAUTION**

If for any reason you do not understand the test procedures or are unable to perform the tests/repairs safely, contact your **Local Lincoln Authorized Field Service Facility** for technical troubleshooting assistance before you proceed.

**SQUARE WAVE TIG 175**



Observe all Safety Guidelines detailed throughout this manual

PROBLEMS (SYMPTOMS)	POSSIBLE AREAS OF MISADJUSTMENTS(S)	RECOMMENDED COURSE OF ACTION
<b>STICK WELDING PROBLEMS</b>		
Stick electrode "Blasts Off" when arc is struck.	1. Weld current may be set too high for electrode size. Reduce current control setting, or use a larger diameter electrode.	Contact your <b>Local Lincoln Authorized Field Service Facility</b> for technical troubleshooting assistance.
Stick electrode "sticks" in the weld puddle.	1. The weld current may be set too low. Increase the current control setting or use a smaller diameter electrode.	

 **CAUTION**

If for any reason you do not understand the test procedures or are unable to perform the tests/repairs safely, contact your **Local Lincoln Authorized Field Service Facility** for technical troubleshooting assistance before you proceed.

**SQUARE WAVE TIG 175**





# WIRING DIAGRAM - SQUARE WAVE TIG 175 (240/380/415/1/50/60)

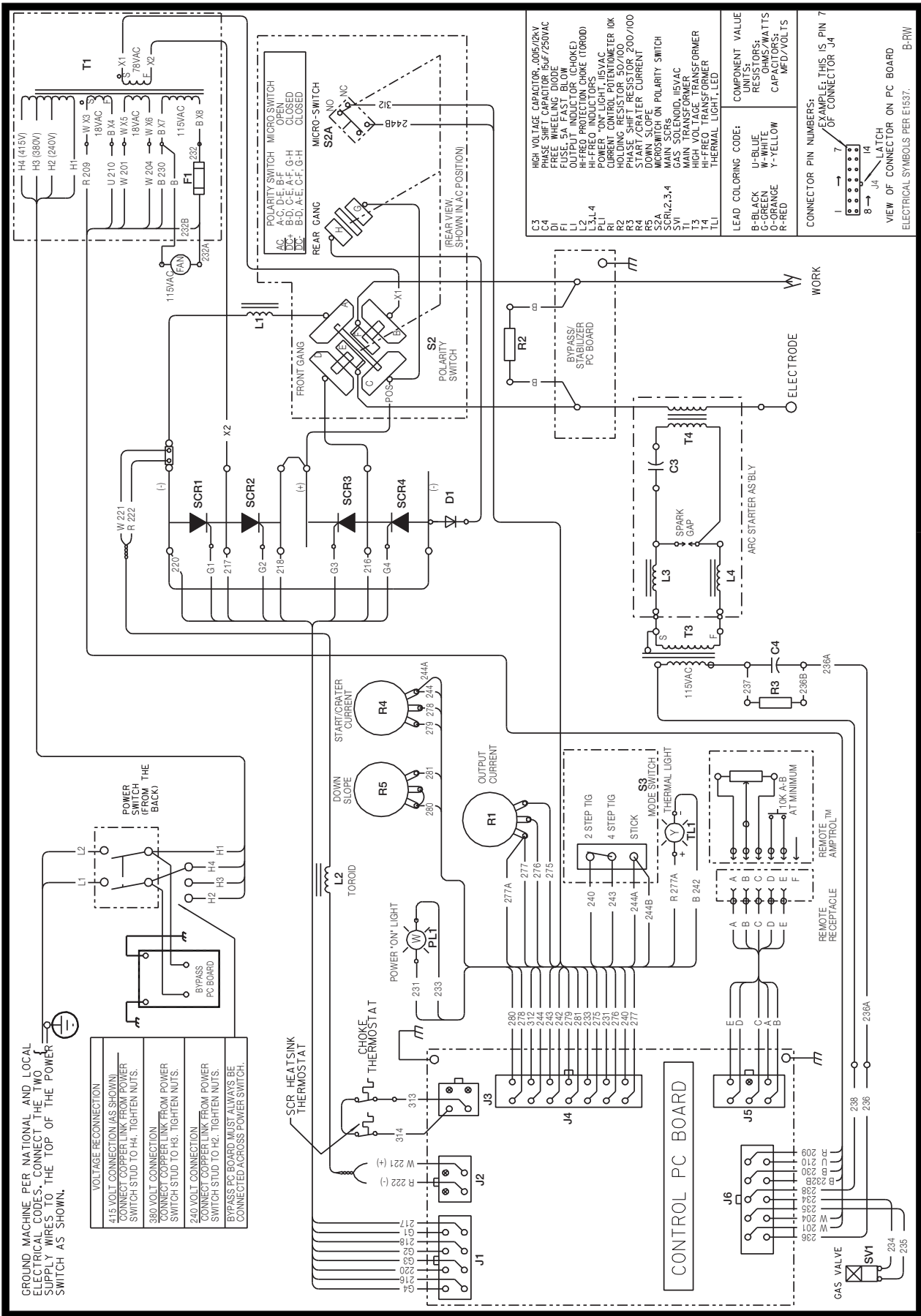

GROUND MACHINE PER NATIONAL AND LOCAL ELECTRICAL CODES. CONNECT THE TWO SUPPLY WIRES TO THE TOP OF THE POWER SWITCH AS SHOWN.

- VOLTAGE RECONNECTION**  
415 VOLT CONNECTION (AS SHOWN)  
CONNECT COPPER LINK FROM POWER SWITCH STUD TO H4. TIGHTEN NUTS.
- 380 VOLT CONNECTION  
CONNECT COPPER LINK FROM POWER SWITCH STUD TO H3. TIGHTEN NUTS.
- 240 VOLT CONNECTION  
CONNECT COPPER LINK FROM POWER SWITCH STUD TO H2. TIGHTEN NUTS.  
BYPASS PC BOARD MUST ALWAYS BE CONNECTED ACROSS POWER SWITCH.

SCR HEATSINK THERMOSTAT

CHOKE THERMOSTAT

POWER ON LIGHT

DOWN SLOPE

START/CRATER CURRENT

OUTPUT CURRENT

MODE SWITCH

THERMAL LIGHT

ARGON STARTER ASSEMBLY

REMOTE RECEPTACLE

REMOTE AMPTRIP™

GAS VALVE

CONTROL PC BOARD

BYPASS/STABILIZER PC BOARD

C3	HIGH VOLTAGE CAPACITOR .0015/2KV	COMPONENT VALUE
C4	PHASE SHIFT CAPACITOR .5UF/250VAC	UNITS:
F1	FUSE 5A 250V	R-RESISTORS;
F2	FUSE 5A 250V	W-WATTAGE
L1	OUTPUT INDUCTOR (CHOKE)	C-CAPACITORS
L2	H-FREED PROTECTION CHOKE (TOROID)	MFD/MFLTS
L3,L4	H-FREED INDUCTORS	
L5	CURRENT LIMITING INDUCTOR	
R1	HOLDING RESISTOR 50/100	
R2	START/CRATER CURRENT	
R3	DOWN SLOPE ON POLARITY SWITCH	
R4	START/CRATER CURRENT	
R5	START/CRATER CURRENT	
R6	START/CRATER CURRENT	
R7	START/CRATER CURRENT	
R8	START/CRATER CURRENT	
SCR1,2,3,4	SCR1,2,3,4	
SV1	GAS SOLENOID .115VAC	
T1	MAIN TRANSFORMER	
T2	HIGH VOLTAGE TRANSFORMER	
TL1	THERMAL LIGHT LEAD	

B-BLACK	LEAD COLORING CODE:
W-WHITE	
G-GREEN	
O-ORANGE	
R-RED	

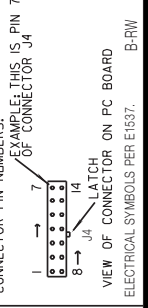

CONNECTOR PIN NUMBERS: FOR EXAMPLE, THIS IS PIN 7 OF CONNECTOR J4

VIEW OF CONNECTOR ON PC BOARD

ELECTRICAL SYMBOLS PER E1537. B-R/W

## SQUARE WAVE TIG 175



7-12-96  
L10087

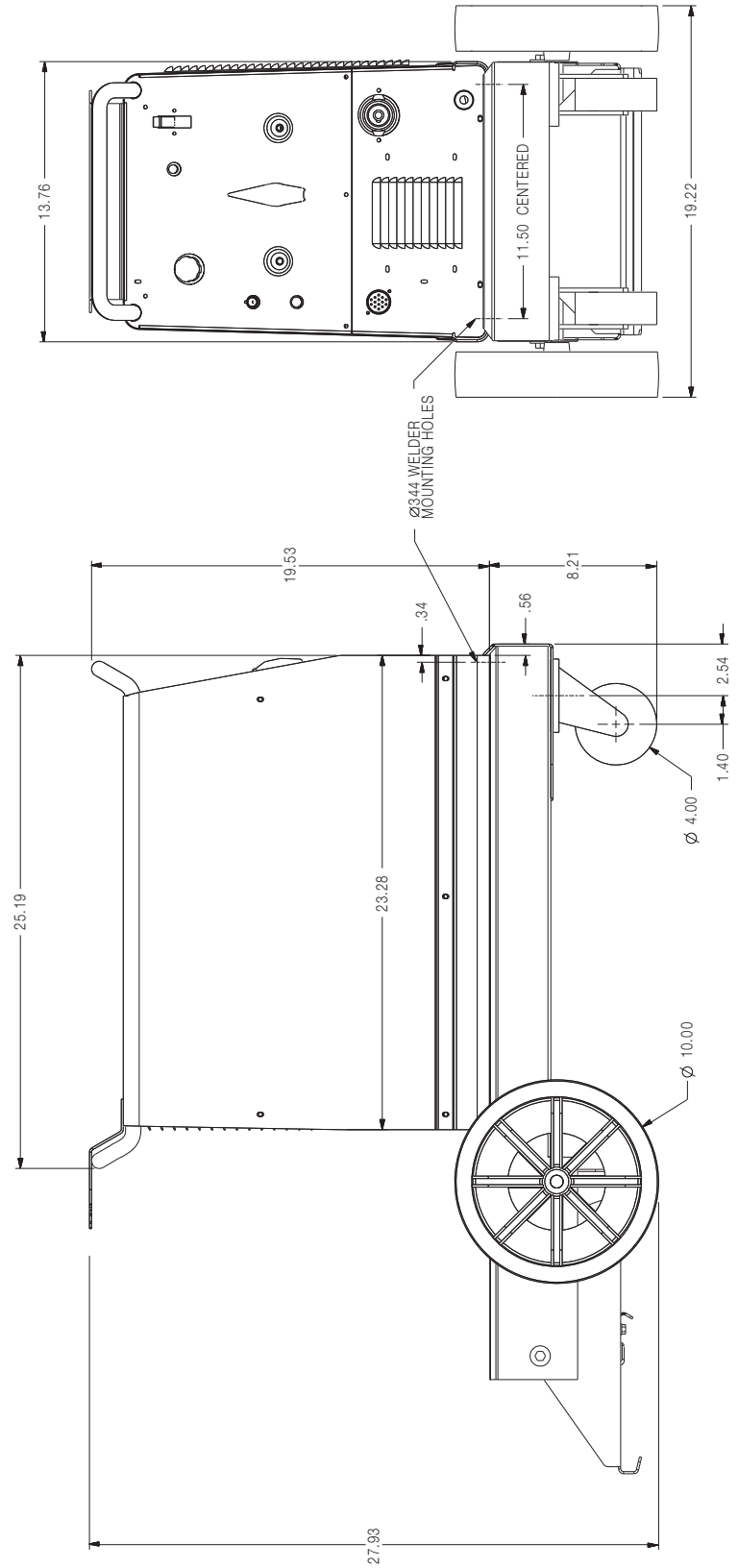
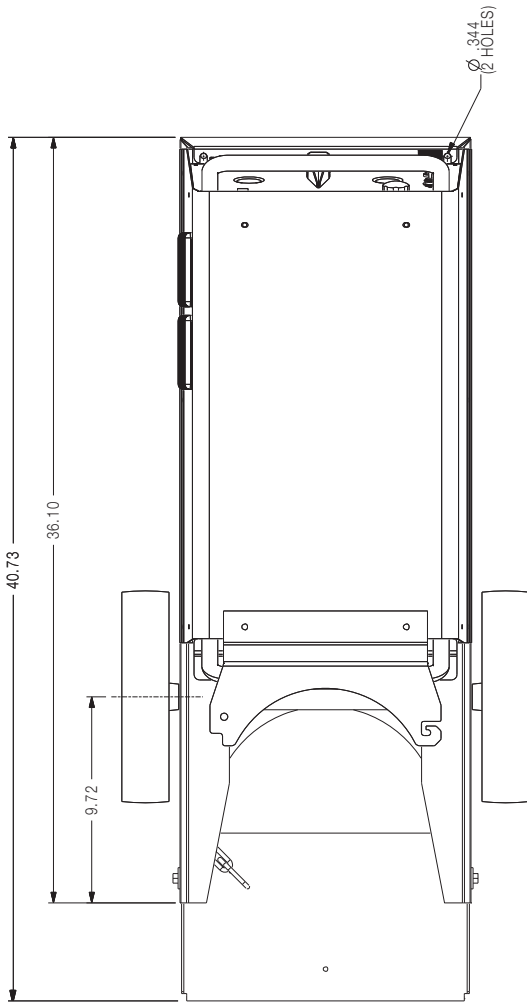

SQUARE WAVE TIG 175



# NOTES

---

SQUARE WAVE TIG 175



SQUARE WAVE TIG 175





<b>WARNING</b>	<ul style="list-style-type: none"> <li>Do not touch electrically live parts or electrode with skin or wet clothing.</li> <li>Insulate yourself from work and ground.</li> </ul>	<ul style="list-style-type: none"> <li>Keep flammable materials away.</li> </ul>	<ul style="list-style-type: none"> <li>Wear eye, ear and body protection.</li> </ul>
Spanish <b>AVISO DE PRECAUCION</b>	<ul style="list-style-type: none"> <li>No toque las partes o los electrodos bajo carga con la piel o ropa mojada.</li> <li>Aislese del trabajo y de la tierra.</li> </ul>	<ul style="list-style-type: none"> <li>Mantenga el material combustible fuera del área de trabajo.</li> </ul>	<ul style="list-style-type: none"> <li>Protéjase los ojos, los oídos y el cuerpo.</li> </ul>
French <b>ATTENTION</b>	<ul style="list-style-type: none"> <li>Ne laissez ni la peau ni des vêtements mouillés entrer en contact avec des pièces sous tension.</li> <li>Isolez-vous du travail et de la terre.</li> </ul>	<ul style="list-style-type: none"> <li>Gardez à l'écart de tout matériel inflammable.</li> </ul>	<ul style="list-style-type: none"> <li>Protégez vos yeux, vos oreilles et votre corps.</li> </ul>
German <b>WARNUNG</b>	<ul style="list-style-type: none"> <li>Berühren Sie keine stromführenden Teile oder Elektroden mit Ihrem Körper oder feuchter Kleidung!</li> <li>Isolieren Sie sich von den Elektroden und dem Erdboden!</li> </ul>	<ul style="list-style-type: none"> <li>Entfernen Sie brennbares Material!</li> </ul>	<ul style="list-style-type: none"> <li>Tragen Sie Augen-, Ohren- und Körperschutz!</li> </ul>
Portuguese <b>ATENÇÃO</b>	<ul style="list-style-type: none"> <li>Não toque partes elétricas e electrodos com a pele ou roupa molhada.</li> <li>Isole-se da peça e terra.</li> </ul>	<ul style="list-style-type: none"> <li>Mantenha inflamáveis bem guardados.</li> </ul>	<ul style="list-style-type: none"> <li>Use proteção para a vista, ouvido e corpo.</li> </ul>
Japanese <b>注意事項</b>	<ul style="list-style-type: none"> <li>通電中の電気部品、又は溶材にヒフやぬれた布で触れないこと。</li> <li>施工物やアースから身体が絶縁されている様にして下さい。</li> </ul>	<ul style="list-style-type: none"> <li>燃えやすいものの側での溶接作業は絶対にしてはなりません。</li> </ul>	<ul style="list-style-type: none"> <li>目、耳及び身体に保護具をして下さい。</li> </ul>
Chinese <b>警告</b>	<ul style="list-style-type: none"> <li>皮肤或湿衣物切勿接触带电部件及焊条。</li> <li>使你自已与地面和工作件绝缘。</li> </ul>	<ul style="list-style-type: none"> <li>把一切易燃物品移离工作场所。</li> </ul>	<ul style="list-style-type: none"> <li>佩戴眼、耳及身体劳动保护用具。</li> </ul>
Korean <b>위험</b>	<ul style="list-style-type: none"> <li>전도체나 용접봉을 젖은 형갑 또는 피부로 절대 접촉치 마십시오.</li> <li>모재와 접지를 접촉치 마십시오.</li> </ul>	<ul style="list-style-type: none"> <li>인화성 물질을 접근시키지 마십시오.</li> </ul>	<ul style="list-style-type: none"> <li>눈, 귀와 몸에 보호장구를 착용하십시오.</li> </ul>
Arabic <b>تحذير</b>	<ul style="list-style-type: none"> <li>لا تلمس الاجزاء التي يسري فيها التيار الكهربائي أو الألكترود بجسد الجسم أو بالملابس المبللة بالماء.</li> <li>ضع عازلا على جسمك خلال العمل.</li> </ul>	<ul style="list-style-type: none"> <li>ضع المواد القابلة للاشتعال في مكان بعيد.</li> </ul>	<ul style="list-style-type: none"> <li>ضع أدوات وملابس واقية على عينيك وأذنيك وجسمك.</li> </ul>

**READ AND UNDERSTAND THE MANUFACTURER'S INSTRUCTION FOR THIS EQUIPMENT AND THE CONSUMABLES TO BE USED AND FOLLOW YOUR EMPLOYER'S SAFETY PRACTICES.**

**SE RECOMIENDA LEER Y ENTENDER LAS INSTRUCCIONES DEL FABRICANTE PARA EL USO DE ESTE EQUIPO Y LOS CONSUMIBLES QUE VA A UTILIZAR, SIGA LAS MEDIDAS DE SEGURIDAD DE SU SUPERVISOR.**

**LISEZ ET COMPRENEZ LES INSTRUCTIONS DU FABRICANT EN CE QUI REGARDE CET EQUIPMENT ET LES PRODUITS A ETRE EMPLOYES ET SUIVEZ LES PROCEDURES DE SECURITE DE VOTRE EMPLOYEUR.**

**LESEN SIE UND BEFOLGEN SIE DIE BETRIEBSANLEITUNG DER ANLAGE UND DEN ELEKTRODENEINSATZ DES HERSTELLERS. DIE UNFALLVERHÜTUNGSVORSCHRIFTEN DES ARBEITGEBERS SIND EBENFALLS ZU BEACHTEN.**

			
<ul style="list-style-type: none"> <li>● Keep your head out of fumes.</li> <li>● Use ventilation or exhaust to remove fumes from breathing zone.</li> </ul>	<ul style="list-style-type: none"> <li>● Turn power off before servicing.</li> </ul>	<ul style="list-style-type: none"> <li>● Do not operate with panel open or guards off.</li> </ul>	<b>WARNING</b>
<ul style="list-style-type: none"> <li>● Los humos fuera de la zona de respiración.</li> <li>● Mantenga la cabeza fuera de los humos. Utilice ventilación o aspiración para gases.</li> </ul>	<ul style="list-style-type: none"> <li>● Desconectar el cable de alimentación de poder de la máquina antes de iniciar cualquier servicio.</li> </ul>	<ul style="list-style-type: none"> <li>● No operar con panel abierto o guardas quitadas.</li> </ul>	Spanish <b>AVISO DE PRECAUCION</b>
<ul style="list-style-type: none"> <li>● Gardez la tête à l'écart des fumées.</li> <li>● Utilisez un ventilateur ou un aspirateur pour ôter les fumées des zones de travail.</li> </ul>	<ul style="list-style-type: none"> <li>● Débranchez le courant avant l'entretien.</li> </ul>	<ul style="list-style-type: none"> <li>● N'opérez pas avec les panneaux ouverts ou avec les dispositifs de protection enlevés.</li> </ul>	French <b>ATTENTION</b>
<ul style="list-style-type: none"> <li>● Vermeiden Sie das Einatmen von Schweißrauch!</li> <li>● Sorgen Sie für gute Be- und Entlüftung des Arbeitsplatzes!</li> </ul>	<ul style="list-style-type: none"> <li>● Strom vor Wartungsarbeiten abschalten! (Netzstrom völlig öffnen; Maschine anhalten!)</li> </ul>	<ul style="list-style-type: none"> <li>● Anlage nie ohne Schutzgehäuse oder Innenschutzverkleidung in Betrieb setzen!</li> </ul>	German <b>WARNUNG</b>
<ul style="list-style-type: none"> <li>● Mantenha seu rosto da fumaça.</li> <li>● Use ventilação e exaustão para remover fumo da zona respiratória.</li> </ul>	<ul style="list-style-type: none"> <li>● Não opere com as tampas removidas.</li> <li>● Desligue a corrente antes de fazer serviço.</li> <li>● Não toque as partes elétricas nuas.</li> </ul>	<ul style="list-style-type: none"> <li>● Mantenha-se afastado das partes moventes.</li> <li>● Não opere com os painéis abertos ou guardas removidas.</li> </ul>	Portuguese <b>ATENÇÃO</b>
<ul style="list-style-type: none"> <li>● ヒュームから頭を離すようにして下さい。</li> <li>● 換気や排煙に十分留意して下さい。</li> </ul>	<ul style="list-style-type: none"> <li>● メンテナンス・サービスに取りかかる際には、まず電源スイッチを必ず切して下さい。</li> </ul>	<ul style="list-style-type: none"> <li>● パネルやカバーを取り外したまま機械操作をしないで下さい。</li> </ul>	Japanese <b>注意事項</b>
<ul style="list-style-type: none"> <li>● 頭部遠離煙霧。</li> <li>● 在呼吸區使用通風或排風器除煙。</li> </ul>	<ul style="list-style-type: none"> <li>● 維修前切斷電源。</li> </ul>	<ul style="list-style-type: none"> <li>● 儀表板打開或沒有安全罩時不準作業。</li> </ul>	Chinese <b>警告</b>
<ul style="list-style-type: none"> <li>● 얼굴로부터 용접가스를 멀리하십시오.</li> <li>● 호흡지역으로부터 용접가스를 제거하기 위해 가스제거기나 통풍기를 사용하십시오.</li> </ul>	<ul style="list-style-type: none"> <li>● 보수전에 전원을 차단하십시오.</li> </ul>	<ul style="list-style-type: none"> <li>● 판넬이 열린 상태로 작동치 마십시오.</li> </ul>	Korean <b>위험</b>
<ul style="list-style-type: none"> <li>● ابعد رأسك بعيداً عن الدخان.</li> <li>● استعمل التهوية أو جهاز ضغط الدخان للخارج لكي تبعد الدخان عن المنطقة التي تتنفس فيها.</li> </ul>	<ul style="list-style-type: none"> <li>● أقطع التيار الكهربائي قبل القيام بأية صيانة.</li> </ul>	<ul style="list-style-type: none"> <li>● لا تشغيل هذا الجهاز اذا كانت الاغطية الحديدية الواقية ليست عليه.</li> </ul>	Arabic <b>تحذير</b>

**LEIA E COMPREENDA AS INSTRUÇÕES DO FABRICANTE PARA ESTE EQUIPAMENTO E AS PARTES DE USO, E SIGA AS PRÁTICAS DE SEGURANÇA DO EMPREGADOR.**

使う機械や溶材のメーカーの指示書をよく読み、まず理解して下さい。そして貴社の安全規定に従って下さい。

請詳細閱讀並理解製造廠提供的說明以及應該使用的銀焊材料，並請遵守貴方的有閣勞動保護規定。

이 제품에 동봉된 작업지침서를 숙지하시고 귀사의 작업자 안전수칙을 준수하시기 바랍니다.

اقرأ بتمعن وافهم تعليمات المصنع المنتج لهذه المعدات والمواد قبل استعمالها واتبع تعليمات الوقاية لصاحب العمل.





• World's Leader in Welding and Cutting Products •

• Sales and Service through Subsidiaries and Distributors Worldwide •

Cleveland, Ohio 44117-1199 U.S.A. TEL: 216.481.8100 FAX: 216.486.1751 WEB SITE: [www.lincolnelectric.com](http://www.lincolnelectric.com)

Download from [Www.Somanuals.com](http://Www.Somanuals.com). All Manuals Search And Download.

## Free Manuals Download Website

<http://myh66.com>

<http://usermanuals.us>

<http://www.somanuals.com>

<http://www.4manuals.cc>

<http://www.manual-lib.com>

<http://www.404manual.com>

<http://www.luxmanual.com>

<http://aubethermostatmanual.com>

Golf course search by state

<http://golfingnear.com>

Email search by domain

<http://emailbydomain.com>

Auto manuals search

<http://auto.somanuals.com>

TV manuals search

<http://tv.somanuals.com>