



CPU SWITCH



LINDY CPU Switch USB Installation and Use



Part	Model
32 341	LINDY CPU Switch USB PC



Part	Model
32 342	LINDY CPU Switch USB Mac

About this manual

LINDY CPU Switch USB - Installation and Use

First edition (January 2000)

Part No. 32341 + 32342

©2000 LINDY Electronics Ltd.

All rights reserved. Whilst every precaution has been taken in the preparation of this manual, LINDY Electronics Ltd assumes no responsibility for errors or omissions. Neither is any liability assumed for damages resulting from the use of the information contained herein. We reserve the right to change the specifications, functions and circuitry of the product without notice. All trademarks acknowledged.

Safety information

- ◆ For use in dry, oil free indoor environments only.
- ◆ Warning - live parts contained within power adapter.
- ◆ No user serviceable parts within power adapter - do not dismantle.
- ◆ Plug the power adapter into a socket outlet close to the LINDY CPU Switch unit that it is powering.
- ◆ Replace the power adapter with a manufacturer approved type only.
- ◆ Do not use the power adapter if the power adapter case becomes damaged, cracked or broken or if you suspect that it is not operating properly.
- ◆ If you use a power extension cord with the LINDY CPU Switch, make sure the total ampere rating of the devices plugged into the extension cord does not exceed the cord's ampere rating. Also, make sure that the total ampere rating of all the devices plugged into the wall outlet does not exceed the wall outlet's ampere rating.
- ◆ Do not attempt to service the LINDY CPU Switch yourself.

Warranty

LINDY Electronics Ltd warrants that this product shall be free from defects in workmanship and materials for a period of one year from the date of original purchase. If the product should fail to operate correctly in normal use during the warranty period, LINDY will replace or repair it free of charge. No liability can be accepted for damage due to misuse or circumstances outside LINDY's control. Also LINDY will not be responsible for any loss, damage or injury arising directly or indirectly from the use of this product. LINDY's total liability under the terms of this warranty shall in all circumstances be limited to the replacement value of this product.

If any difficulty is experienced in the installation or use of this product that you are unable to resolve, please contact your supplier.

Trademarks

All trademarks mentioned in this manual are acknowledged to be the property of the respective trademark owners.

Compaq is a registered trademark of Compaq Computer Corporation.

Hewlett-Packard is a registered trademark of Hewlett-Packard.

IBM, PC/AT, PS/2, RS/6000 and ThinkPad are registered trademarks of International Business Machines Corporation.

Logitech, MouseMan+ and Pilot Mouse+ are trademarks of Logitech Inc.

Microsoft and Windows are registered trademarks, and IntelliMouse is a trademark of Microsoft Corporation.

Velcro is a trademark of Velcro USA Inc.

Radio Frequency Energy

Shielded cables must be used with this equipment to maintain compliance with radio frequency energy emission regulations and ensure a suitably high level of immunity to electromagnetic disturbances.

European EMC directive 89/336/EEC

This equipment has been tested and found to comply with the limits for a class B computing device in accordance with the specifications in the European standard EN55022. These limits are designed to provide reasonable protection against harmful interference. This equipment generates, uses and can radiate radio frequency energy and if not installed and used in accordance with the instructions may cause harmful interference to radio or television reception. However, there is no guarantee that harmful interference will not occur in a particular installation. If this equipment does cause interference to radio or television reception, which can be determined by turning the equipment on and off, the user is encouraged to correct the interference with one or more of the following measures: (a) Reorient or relocate the receiving antenna. (b) Increase the separation between the equipment and the receiver. (c) Connect the equipment to an outlet on a circuit different from that to which the receiver is connected. (d) Consult the supplier or an experienced radio / TV technician for help.

FCC Compliance Statement (United States)

This equipment generates, uses and can radiate radio frequency energy and if not installed and used properly, that is, in strict accordance with the manufacturer's instructions, may cause interference to radio communication. It has been tested and found to comply with the limits for a class A computing device in accordance with the specifications in Subpart J of part 15 of FCC rules, which are designed to provide reasonable protection against such interference when the equipment is operated in a commercial environment. Operation of this equipment in a residential area may cause interference, in which case the user at his own expense will be required to take whatever measures may be necessary to correct the interference. Changes or modifications not expressly approved by the manufacturer could void the user's authority to operate the equipment.

Canadian Department of Communications RFI statement

This equipment does not exceed the class A limits for radio noise emissions from digital apparatus set out in the radio interference regulations of the Canadian Department of Communications.

Le présent appareil numérique n'émet pas de bruits radioélectriques dépassant les limites applicables aux appareils numériques de la classe A prescrites dans le règlement sur le brouillage radioélectriques publié par le ministère des Communications du Canada.

Contents

1. Introduction	6
1.1 Key features.....	6
1.2 Package contents (models 32 341 and 32 342)	7
1.3 Remote controller contents (part code: 32 255)	7
1.4 Product information	8
2. Installation	10
2.1 What you will need	10
2.2 Mounting the LINDY CPU Switch USB	11
2.3 Connecting your devices	11
2.4 Configuring the LINDY CPU Switch USB.....	14
2.4.1 Setting the USB enumeration guard time	15
2.4.2 Setting the autoscan dwell time	15
2.4.3 Setting the LINDY CPU Switch USB to scan all ports or just the active ports	16
2.4.4 Setting the keyboard hotkey combination	16
2.4.5 Enabling and disabling mouse channel switching	16
2.5 Powering on the LINDY CPU Switch USB	17
2.6 Configuring your computers	17
2.7 Re-enabling a disconnected PS/2 mouse	17

3. Using the LINDY CPU Switch USB	18
3.1 Power on status	18
3.2 Front panel key	18
3.3 Switching between computers using the LINDY CPU Switch USB	19
3.4 Status display	19
3.5 Keyboard hotkey control	20
3.6 Mouse control	22
3.7 Autoscan mode	22
3.8 The optional remote controller	22
3.9 Querying the LINDY CPU Switch USB's firmware version	23
3.10 PC and Macintosh keyboard equivalent key mappings	23

Appendices

A - Cable specifications.....	24
A1 USB cables.....	24
A2 Video cables	24
A3 PS/2 style keyboard and mouse extension cables	25
A4 Remote controller extension cables	25
B – Problem Solving.....	26

1. Introduction

Thank you for purchasing the LINDY CPU Switch USB. Your LINDY CPU Switch USB is a high performance keyboard, monitor, mouse and peripheral sharing device which supports a wide range of hardware and software platforms and connects to your computers via their USB ports.

1.1 Key features

PC and MAC models

- Enables a keyboard, monitor, mouse and range of USB peripherals to be switched between four USB-enabled computers.
- Uses new innovative technology that is Patent Pending in the U.K.
- Numeric status display and front panel pushbutton make computer selection easy.
- Supports high quality video resolutions up to 1600 x 1280 pixels and screen refresh rates up to 100 Hz.
- Each computer may be connected using just one standard USB cable and one standard video cable.
- Robust metal chassis sits securely on your desktop.
- Internal USB hub function enables 3 USB peripherals to be connected. More USB peripherals may be added by using additional USB hubs.
- LINDY CPU Switch USB has its own power supply and consequently will power USB hubs attached to its peripheral ports. This enables keyboards with integral hubs and other non-powered USB hubs to be supported.
- Available in attractive translucent blue to match with your computer equipment.
- Remote controller option enables the LINDY CPU Switch USB to be controlled from a small neat remote control unit that may be attached to the top of a keyboard or the side of a monitor.

- Supports monitor display data channel signalling (DDC1 & DDC2) enabling your computer to communicate with the monitor.
- Supports autoscan for easy monitoring of computer activity.
- Enables switching between all computer ports or just active computer ports for maximum convenience.

PC models

- PS/2-style keyboard and mouse ports enable a traditional style PC keyboard and mouse to be connected to the LINDY CPU Switch USB.
- LINDY CPU Switch USB's channel can be changed using keyboard hotkeys or a 3-button mouse.
- Traditional style PS/2 keyboard and mouse signals automatically converted to USB format within the LINDY CPU Switch USB.
- Keyboard and mouse activity indication.
- Video blanking feature.

1.2 Package contents (models 32 341 and 32 342)

- LINDY CPU Switch USB.
- Power adapter.
- This installation guide.

1.3 Remote controller contents (part code: 32 255)

- Remote control module.
- Velcro strip for mounting remote controller.

1.4 Product information

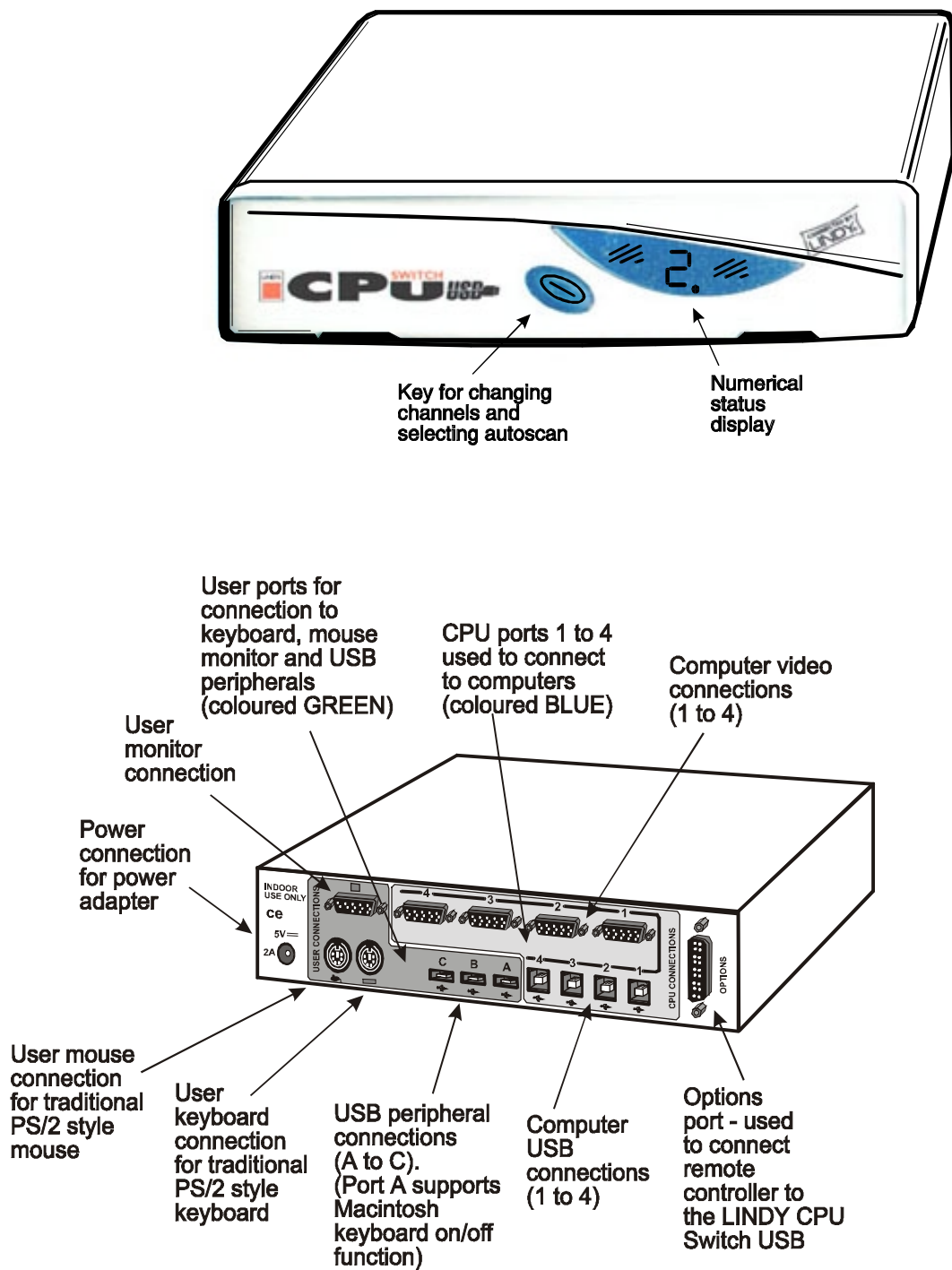

Fig. 1 – LINDY CPU Switch USB model 32 341

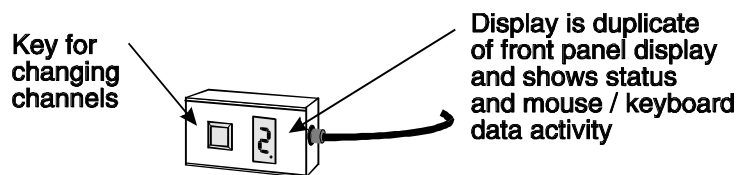

Fig. 2 - Remote control pad / display (optional accessory) (Part: 32 255)

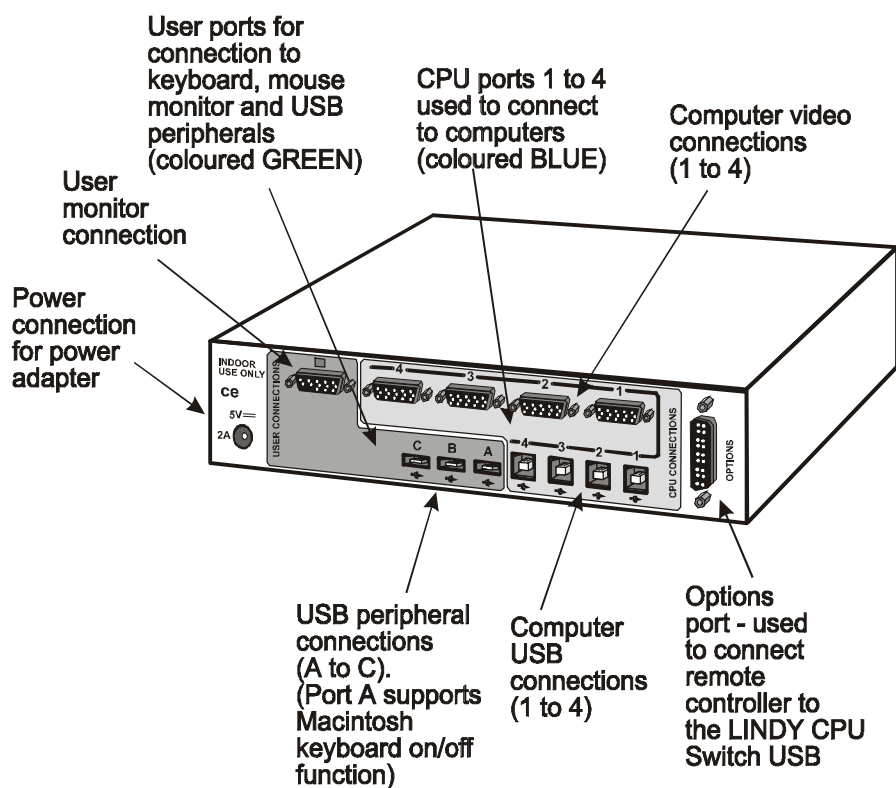
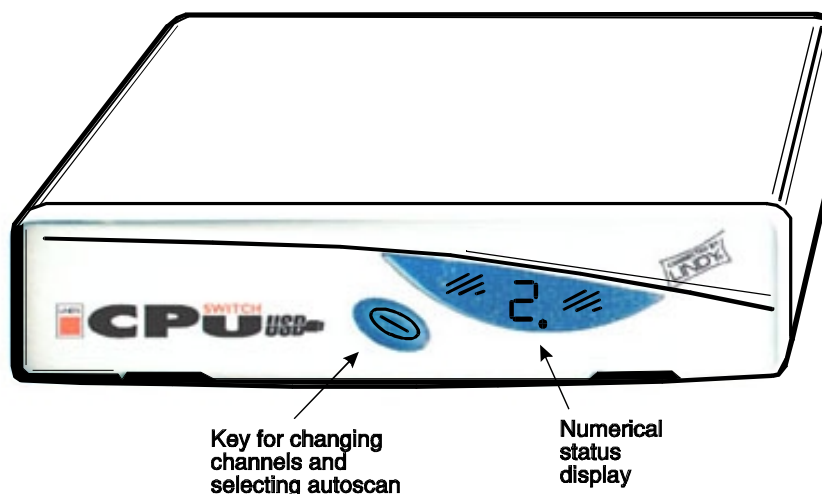

Fig. 3 – LINDY CPU Switch USB model 32 342

2. Installation

2.1 What you will need

- A suitable USB-enabled operating system running on each of your computers. Suitable operating systems are Windows 98 release 2 or later and Mac OS 8.6 or later. Earlier operating system versions are not recommended and may cause occasional problems. Other operating systems such as Windows[®] 2000, HP-UX[®], Linux[®], SCO[®] UNIX[®], and Novell[®] NetWare[®] have USB support or are likely to add it soon. DOS, Windows 3.x, Windows 95 and Windows NT either do not support USB or are not recommended for use with the LINDY CPU Switch USB.
- Cables to connect the LINDY CPU Switch USB to a USB and video port on each of your computers. Cable specifications are given in appendix A.
- A monitor with a standard VGA/SVGA (15 pin) connector that will work when connected directly to each of your computers. LINDY CPU Switch USB supports low and high resolution monitors.
- Suitable USB drivers for all the USB peripherals that you wish to connect to the LINDY CPU Switch USB. Common drivers, such as those for keyboards and mice, are usually included with the operating system. If you are connecting to both PC and Apple Macintosh computers then you should ensure that you have drivers for both platforms.
- If you wish to connect more than three USB peripherals to the LINDY CPU Switch USB then you will need additional USB hubs. These may be bus powered or powered with their own independent power supplies. All USB hubs should be at least USB 1.0 compliant and should preferably be USB 1.1 compliant.
- A suitable keyboard and mouse. If you have LINDY CPU Switch USB Mac model 32 342 then these must be USB devices. If you have the LINDY CPU Switch USB PC model 32 341 then these may be USB style devices or traditional PS/2 style devices. If you are connecting to both PC and Macintosh machines then it is recommended that you use a PC keyboard and mouse because the PC keyboard and mouse has more keys and buttons than the Macintosh keyboard and mouse. If you wish you may connect both types of keyboard or mouse for convenience.

You may connect standard 2 or 3 button PS/2 or IntelliMouse compatible mice to the PS/2 mouse port on the LINDY CPU Switch USB PC model 32 341. The LINDY CPU Switch USB supports 'Internet Mice' that are compatible with the Microsoft IntelliMouse. These are fitted with a wheel or other scroll control and sometimes have additional buttons.

Examples are:

All LINDY Mice
Microsoft IntelliMouse
Logitech Pilot Mouse +
Logitech MouseMan+
Genius NetMouse
Genius NetMouse Pro

If you are using an AT keyboard with a 5 pin connector you may connect this to the LINDY CPU Switch USB using a standard AT to PS/2 keyboard adapter. If you do not wish to use a keyboard and mouse then the LINDY Switch USB will operate without these devices connected. If you wish to use the PS/2 style mouse to switch the LINDY CPU Switch USB's channel then you will need a three button mouse or a LINDY mouse.

2.2 Mounting the LINDY CPU Switch USB

The LINDY CPU Switch USB has been designed for use on a desktop or shelf in close proximity to the user's monitor and peripherals. The optional remote controller may be used if you wish to locate the LINDY CPU Switch USB on a desk or shelf that is some distance from the monitor and peripherals.

2.3 Connecting your devices

Ensure that the power adapter is disconnected from the LINDY CPU Switch USB and that all the devices which are to be attached are switched off. Connect your keyboard, mouse and monitor to the connectors at the rear of the LINDY CPU Switch USB (see figs 1, 2 and 3). Your user and peripheral devices should plug directly into the LINDY CPU Switch USB.

Next connect each computer system unit in turn with a USB and a video cable. The

USB cable has different connectors on each end. This ensures that it connects to the correct ports. The type A connector (rectangular) plugs into the computer and the type B connector (square) plugs into the LINDY CPU Switch USB. USB cables should be no longer than 5 metres but this distance may be extended with the use of USB hubs. You should use tri-coax video cables to achieve a good video picture (the type of thick cable that you see on computer monitor connections). Lower quality 'data' cables will function correctly but will generally give relatively poor video pictures and are only suitable for screen resolutions of 640 x 480. Any unused computer connections can be left unconnected.

If you are using an Apple Macintosh computer and you wish to use the on/off key function on the keyboard then you must connect the keyboard directly to the LINDY CPU Switch USB's peripheral port A. If you are using this on/off key function then you will also not be able to use an additional USB hub to extend the cable run between the computer and the LINDY CPU Switch USB. This is because the Macintosh on/off key function is not supported through a USB hub.

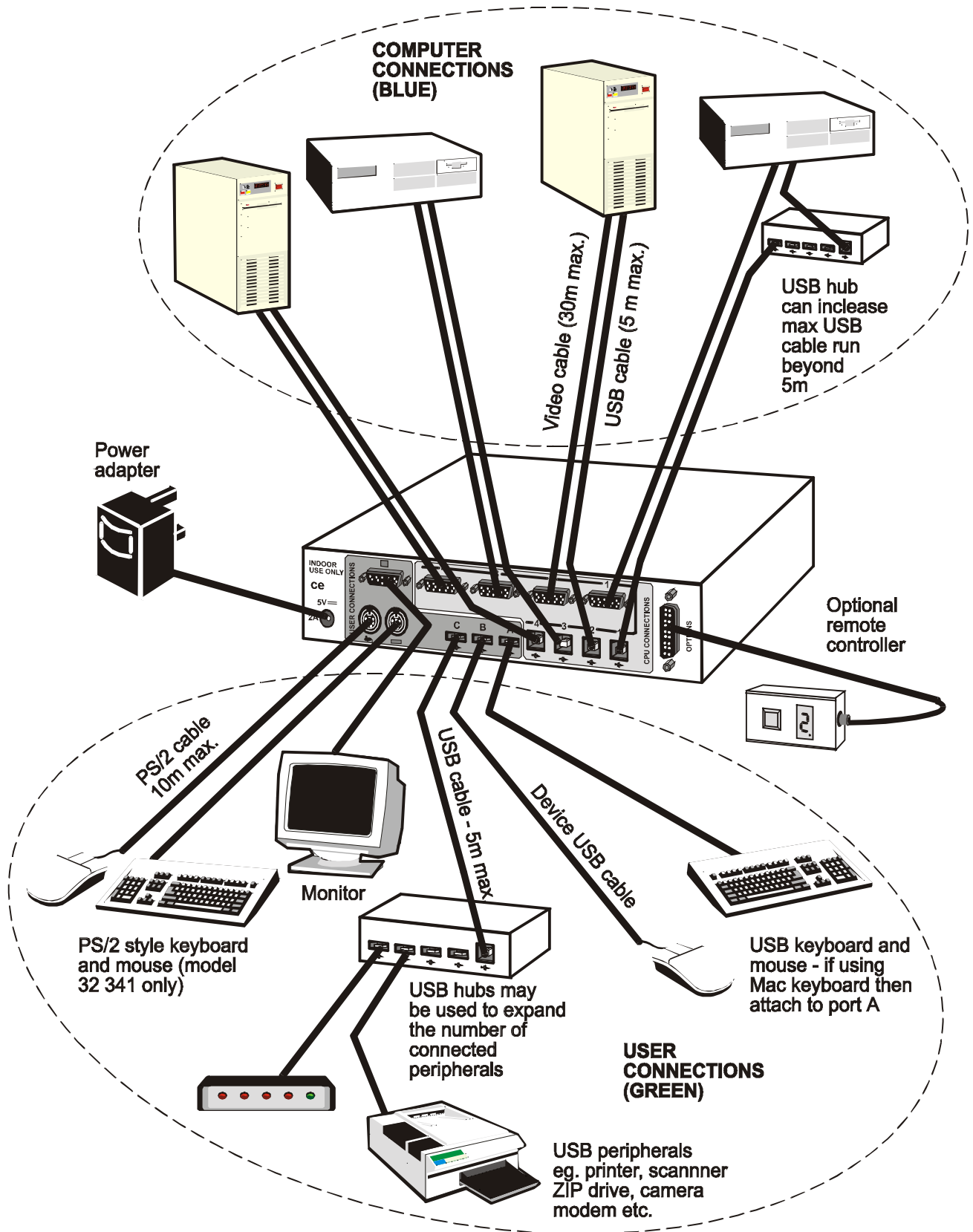
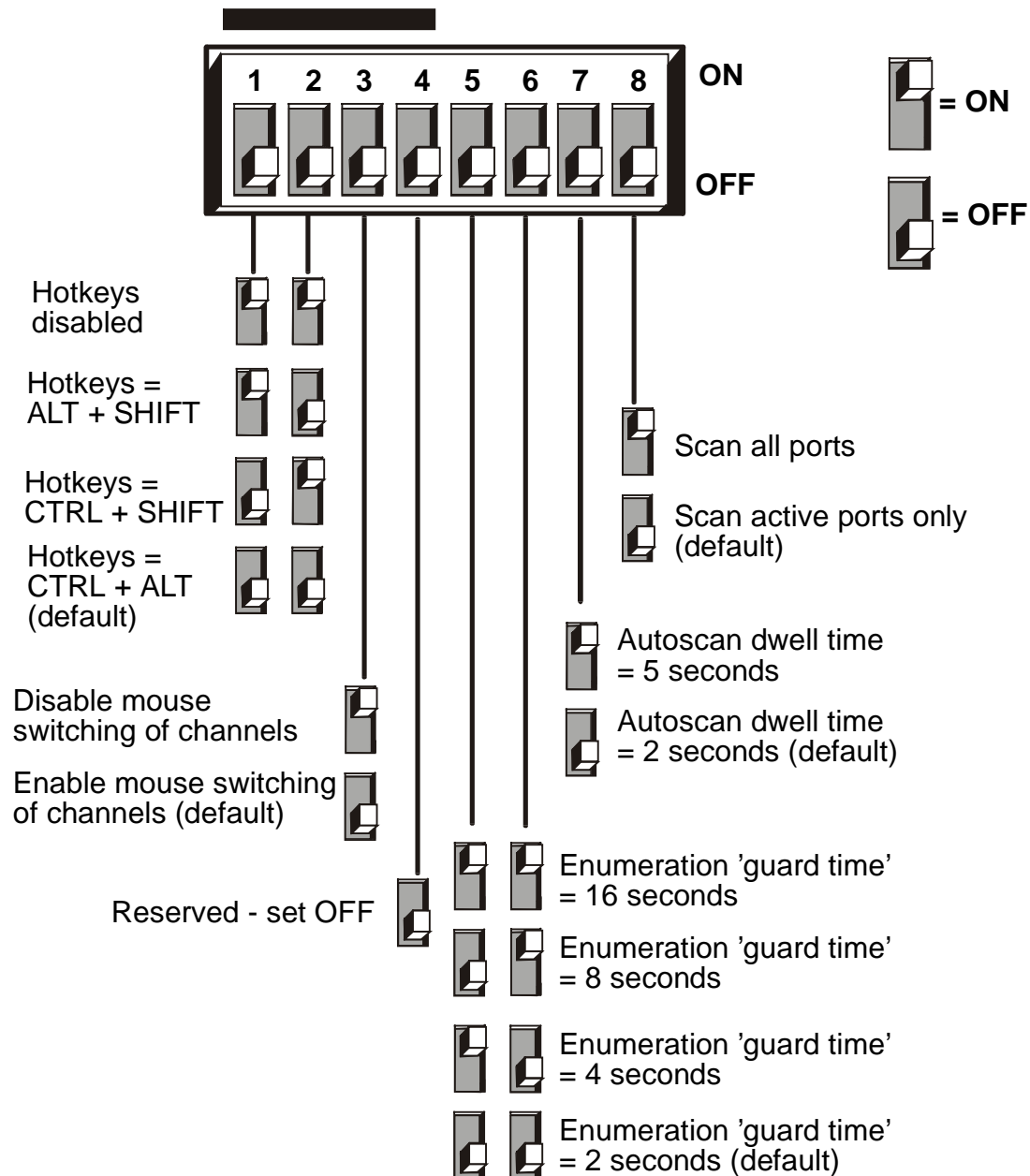

Figure 4 - a typical LINDY CPU Switch USB installation whereby a range of peripherals are shared between four computers

2.4 Configuring the LINDY CPU Switch USB

The LINDY CPU Switch USB is supplied pre-configured with factory defaults which are suitable for most applications. A row of option switches on the underside of the LINDY CPU Switch USB may be used to select various other configuration options as follows:

Switches 1 to 4 are only applicable to the LINDY CPU Switch USB 32 341



2.4.1 Setting the USB enumeration guard time (option switches 5 and 6)

A USB-enabled computer detects and configures USB peripherals when they are connected to or disconnected from its USB ports. This process is called enumeration. You can often see when the enumeration process is in progress as the computer will usually display a timer or hourglass for a few seconds after the connection of a USB peripheral whilst the device is being enumerated.

This enumeration process will take place each time that the LINDY CPU Switch USB locks on to a new computer port. Unfortunately computer software is not generally robust enough to cope with the connection between the computer and peripherals being broken during this enumeration process. If the connection is lost part of the way through the enumeration process then the computer software or the peripherals can hang.

To overcome this problem the LINDY CPU Switch USB is fitted with an enumeration guard timeout system. Once the LINDY CPU Switch USB has locked on to a channel it will remain connected to that channel for at least the enumeration guard time. This ensures that the enumeration process is complete before further channel changes are allowed and consequently ensures robust and reliable operation.

The enumeration process takes longer if more peripherals are connected. Select an enumeration time that is longer than the longest observed enumeration time. The enumeration time can be judged by the length of time that the hourglass or timer remains on the computer screen after a channel change (normally a few seconds). Alternatively you may select the shortest enumeration guard time (2 seconds) and remember not to change the channel whilst the hourglass or timer is displayed.

2.4.2 Setting the autoscan dwell time

The LINDY CPU Switch USB may be made to autoscan the connected computers. During autoscan the LINDY CPU Switch USB displays the video signal from each computer in turn for a selected time period. This time period is known as the dwell time and may be selected to be 2 or 5 seconds using option switch 7. Ports are scanned in ascending numerical sequence and all the ports or just the active ports will be scanned according to the setting of option switch 8.

2.4.3 Setting the LINDY CPU Switch USB to scan all ports or just the active ports

The LINDY CPU Switch USB's front panel button may be used to select the required computer. To avoid the need to press the key more times than necessary the LINDY CPU Switch USB may be set to scan just the ports that have powered computers attached. When the LINDY CPU Switch USB has been set to scan these 'active' ports, only these ports may be selected using the front panel button. If you wish to be able to select all the ports, regardless of whether the connected computers are powered on or not, then the LINDY CPU Switch USB may be set to scan all ports. The scan strategy is selected using option switch 8. This setting also controls the ports that are scanned during autoscan and the ports that may be selected using the keyboard hotkeys+TAB or a 3-button mouse (model 32 341 only).

The LINDY CPU Switch USB determines if a port is active by monitoring the signals present on the USB interface cable. The LINDY CPU Switch USB is not able to detect an active computer if a USB cable from that computer is not connected to the LINDY CPU Switch USB.

2.4.4 Setting the keyboard hotkey combination (model 32 341 only)

The LINDY CPU Switch USB's channel may be selected by pressing keyboard hotkey combinations on the keyboard attached to the PS/2 keyboard port. Keyboard hotkey combinations consist of three keys that are pressed together to activate the required function. For example, pressing CTRL and ALT and 2 together would select channel 2 (assuming the default hotkeys). Certain hotkey combinations may sometimes be used by other systems or software so various different hotkey combinations may be selected. Options switches 1 and 2 are used to select the required hotkey combination or disable the hotkeys.

2.4.5 Enabling and disabling mouse channel switching (model 32 341 only)

A three button PS/2 mouse or an IntelliMouse can be used to switch channels on the LINDY CPU Switch USB. To switch to the next channel, the user simply holds down the central button or wheel button and presses the left hand button to change channel. If the user does not wish to take advantage of this feature, it can be

disabled using option switch 3. If the third button is being used to switch the LINDY CPU Switch USB then it is not available for use with PC software although the function of an IntelliMouse wheel is not affected. If you wish to use the full function of a 3 button mouse or IntelliMouse for your PC software then you should disable mouse channel switching.

2.5 Powering on the LINDY CPU Switch USB

The LINDY CPU Switch USB is powered from the supplied mains power adapter. There is no on/off switch on the LINDY CPU Switch USB so it will start to operate as soon as the power adapter has been connected to the LINDY CPU Switch USB and plugged into the mains supply.

2.6 Configuring your computers

We recommend that you configure each computer in turn for operation with your USB devices without changing the LINDY CPU Switch USB's channel. Configure your computers as if the USB devices were connected directly to the computer. Some PC compatible computers may not recognise a USB keyboard or mouse until a suitable driver has been loaded. It may only be possible to load these drivers if you have keyboard and mouse control and so consequently you may need to connect a traditional style PS/2 keyboard and mouse to load the USB drivers. Once these USB drivers have been loaded the PS/2 keyboard and mouse may be disconnected.

Remember that you must be using a suitable operating system such as Windows 98 or Mac OS 8.6.

If you are using a version of Apple's operating system earlier than 8.6 then you must upgrade to a later version. This upgrade is available on Apple's website. If you use an earlier operating system then your peripherals will hang after typically 25 channel changes.

2.7 Re-enabling a disconnected LINDY PS/2 mouse (32 341 only)

If you disconnect the LINDY PS/2-style mouse from the LINDY CPU Switch USB by accident during operation then the mouse operation will be lost when the mouse is plugged back in. To avoid having to reboot the entire system in this situation the LINDY CPU Switch USB is fitted with an automatic mouse recovery system. With the LINDY PS/2 mouse disconnected, change the channel using the front panel key or keyboard hotkeys. The LINDY CPU Switch USB detects that the mouse

has been disconnected and triggers the automatic recovery system. Plug in the LINDY PS/2 mouse and the LINDY CPU Switch USB will re-initialise it.

3. Using the LINDY CPU Switch USB

This section explains the general operation of the LINDY CPU Switch USB. We recommend that you read this section before starting to use the product.

3.1 Power on status

At power on the LINDY CPU Switch USB selects computer number 1 and displays '1' on the front panel numerical display.

3.2 Front panel key

The front panel key is used to select which channel (1 to 4) is currently connected to the user ports (coloured green on the rear panel) and which is currently controlled by the shared keyboard, mouse and monitor. Pressing the key during normal operation will cause the next computer channel to be selected.

Depending on the position of option switch 8, pressing the front panel key will either select the next active computer channel or the next computer channel in numerical sequence (1,2,3,4,1,2,3 etc.).

Using the front panel key you may cycle through the available computer channels until you find the required port. When the LINDY CPU Switch USB detects that no new key presses have occurred for a second it will start the channel lock-on process. During the lock-on process the display will flash to indicate that the LINDY CPU Switch USB is currently waiting for the enumeration guard period (see section 2.4.1). The channel may not be changed again until this process is complete and the display stops flashing.

The front panel key may be used to select autoscan mode. Autoscan mode is activated by holding the key down for more than 5 seconds until the display starts to show a rotating segment. Autoscan mode may be cancelled by pressing the front panel key whilst within autoscan mode.

3.3 Switching between computers using the LINDY CPU Switch USB

When you select a new computer using the LINDY CPU Switch USB, the peripherals that were connected to the old computer will be disconnected and allocated to the new computer regardless of whether they are currently servicing jobs on the old computer. For example, if you are printing from the old computer and you switch to a new computer before the print job is complete then only part of your print job will actually be printed.

In particular you should avoid switching computers whilst a computer is reading or writing data to a USB data storage device such as a ZIP drive. Where practical it is advisable to eject removable disks on USB drives before switching computers.

3.4 Status display

The status display usually shows the currently selected port. If autoscan mode is selected, the segments will illuminate in sequence in a clockwise direction interspersed with a display of the currently selected channel. If the LINDY CPU Switch USB is waiting for the enumeration guard process to complete then the display will flash. Data flow from the mouse or keyboard attached to the PS/2 style keyboard and mouse ports (model 32 341 only) causes the dot in the lower right hand corner of the display to flash.

DISPLAY SHOWS

MEANING

Channel number
displayed steadily

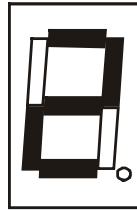

The computer channel
shown is selected

Display flashes
port number

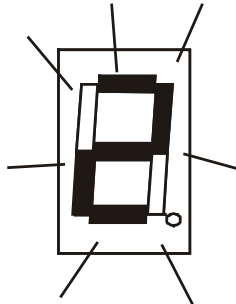

The computer channel
has just been changed
and the LINDY CPU Switch
USB is waiting for the
enumeration guard process
to complete

Illuminated segment
shifts clockwise with
port number shown
after each scan round

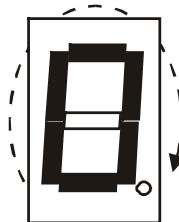

Auto-scan mode -
scanning from channel
to channel at rate as
selected by user

Dot in lower right
hand corner of
display flashes
(model 32 341
only)

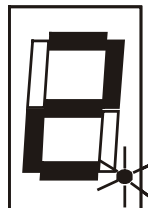

Data is being received
from the keyboard or
mouse attached to the
PS/2 style keyboard and
mouse ports

3.5 Keyboard hotkey control (model 32 341 only)

The LINDY CPU Switch USB may be conveniently controlled by pressing keyboard hotkey combinations on the keyboard attached to the PS/2 style keyboard port (see figure 4). All of the hotkey control commands are invoked by holding down the two hotkeys and then pressing a command key. By default, the two hotkeys are 'CTRL' and 'ALT', although other combinations can be selected (see section 2.4.4). Once the hotkey command has been activated you will need to release the hotkeys and

the command key before a new hotkey command is accepted by the LINDY CPU Switch USB. HOTKEYs + TAB is an exception and this allows you to 'tab through' the ports by holding down the hotkeys and repeatedly pressing TAB.

The hotkey command are summarised below (note that the numbers on the numeric keypad do not form part of a valid hotkey) :

'HOTKEYs' and '1' - selects channel 1

'HOTKEYs' and '2' - selects channel 2

'HOTKEYs' and '3' - selects channel 3

'HOTKEYs' and '4' - selects channel 4

'HOTKEYs' and 'TAB' - selects the next channel. The next channel may be the next active channel or the next channel in numerical sequence depending upon the position of option switch 8 (see section 2.4.3).

'HOTKEYs' and 'A' - selects autoscan mode where each channel's video is displayed for the selected time (see section 2.4.2). To cancel autoscan mode simply select any fixed channel either by hotkey or by using the front panel button.

'HOTKEYs' and '0' – switches off the video signal and displays 0. This will cause some monitors to go into standby mode or switch off. The video signal can be re-enabled by selecting a channel.

Examples of common hotkey sequences (assuming CTRL + ALT hotkey option):

To select channel 2:

Press    release   

To 'tab through' channels:

Press    release  press 

release  press  release   

3.6 Mouse control (model 32 341 only)

The LINDY CPU Switch USB's channels may be changed using a three button mouse or IntelliMouse. In order to switch to the next channel simply hold down the central mouse button or wheel button and click on the left hand mouse button. The channel will then change to the next channel. The next channel may be the next active channel or the next channel in numerical sequence depending on the setting of option switch 8 (see section 2.4.3).

3.7 Autoscan mode

Autoscan mode may be selected by holding the front panel key down for 5 seconds or by using the keyboard hotkeys. When autoscan mode has been activated the front panel display will alternately show a rotating segment and the currently selected channel. The video from each computer will be displayed for the time period selected by option switch 7 (either 2 seconds or 5 seconds). During autoscan all the USB peripherals remain disconnected and only the video signals are switched through. Depending upon the position of option switch 8, the LINDY CPU Switch USB will lock-on to all the computer ports or just the active computer ports.

Many modern monitors are fitted with automatic power save relays and will switch off after a few seconds if connected to an inactive PC. If you are using such a monitor you must not scan inactive ports. Constant switching on and off of your monitor's relay will eventually damage your monitor.

3.8 The optional remote controller

An optional remote controller is available which replicates the front panel key and display, but can be located remotely from the LINDY CPU Switch USB. The remote controller plugs into the options port on the back of the LINDY CPU Switch USB (see figures 1 and 2). This remote controller is particularly useful in applications where the LINDY CPU Switch USB is located away from the user's desktop. The remote controller can be conveniently attached to your keyboard with a couple of Velcro strips to give instant channel information and key control. The key and display on the remote controller perform exactly the same function as the key and display on the front panel of the LINDY CPU Switch USB. The remote controller is supplied with a 3 metre cable but this may be extended if necessary to 20 metres.

3.9 Querying the LINDY CPU Switch USB's firmware version

For technical support reasons it may sometimes be desirable to know the firmware version of your LINDY CPU Switch USB. If the front panel key is held down whilst the LINDY CPU Switch USB is powered on then the firmware version will be displayed as a sequence of numbers and characters. The three digits of the firmware version are shown in sequence on the 7-segment display, one at a time, alternating with the letter F. When the firmware version has been displayed the LINDY CPU Switch USB will display and equals sign and resume normal operation. For example the following sequence would indicate firmware version 1.23.



3.10 PC and Macintosh keyboard equivalent key mappings

If you are connecting a mixture of IBM compatible PCs and Macintosh computers to the LINDY CPU Switch USB then you have several possible keyboard configuration options. You may decide to connect both a Macintosh and PC style keyboard to the LINDY CPU Switch USB and use the appropriate keyboard for the appropriate system. Alternatively you may wish to use the same keyboard to control both systems. In this case we recommend that you use a PC 104/105-key keyboard. This has more keys than the Macintosh keyboard and so is more suited to universal use.

The equivalent key mappings on the IBM PC 104/105 –key keyboard and the Apple keyboard are shown in the following table:

IBM 104/105-key keyboard	Apple keyboard
Left Ctrl	Left Control
Left Win Start (⊞)	Left Command (⌘)
Left Alt	Left Option (alt)
Right Alt or Alt Graph	Right Option (alt)
Right Win Start (⊞)	Right Command (⌘)
Right Ctrl	Right Control
Windows Application (⊞)	No equivalent
No equivalent	On / off key

Appendix A. Cable specifications

Shielded cables must be used with this equipment to maintain compliance with radio frequency energy emission regulations and ensure a suitably high level of immunity to electromagnetic disturbances.

A1. USB cables

The construction and maximum length of USB cables is specified in the USB standard. You should only use cables that conform to this USB standard. These cables will be shielded and no longer than 5 metres in length. USB cables have different types of connectors at each end to avoid incorrect connection.

USB peripherals that carry integral cables, such as some keyboards and mice may be connected directly to the LINDY CPU Switch USB or may be connected to the LINDY CPU Switch USB via a USB hub (see figure 4). USB hubs may be used to extend the overall USB cable run beyond the 5 metre limit.

A2. Video cables

You will require a video cable for each computer that you wish to connect. The LINDY CPU Switch USB uses standard video cables that are terminated at each end with a standard 15-way high density D-type male video connector. All the pins on the cable are connected straight through.

We strongly recommend that you use tri-coax 75 ohm video cables that are specifically designed to carry video signals. Good quality 10 metre long tri-coax video cables show little loss of video quality. Lengths up to 30 metres long will usually give an acceptable video picture although the quality falls off as the length increases. You should therefore generally use the minimum length possible.

Tri-coax video cables can easily be identified as they are roughly the same thickness as a monitor's video cable and are usually lightly fluted on the outside. Cheaper and thinner 'data' cables are widely available but are only suitable for low video resolutions. Where possible these cheaper cables should be avoided.

Your monitor will plug directly into the back of the LINDY CPU Switch USB, however

if you wish to extend the distance between the LINDY CPU Switch USB and the monitor then you may use a tri-coax video extension cable. This cable should preferably be no longer than 10 metres although cable runs up to 20 metres long may also give acceptable video quality.

A3. PS/2 style keyboard and mouse extension cables

PS/2 style keyboards and mice will plug directly into the LINDY CPU Switch USB model 32 341. If required the keyboard and mouse may be located further away from the LINDY CPU Switch USB with the aid of extension cables. Extension cables should be terminated with 6 pin mini-DIN PS/2 style connectors, with a male connector on one end and a female connector on the other end. All pins on the extension cable should be wired straight through (1 to 1, 2 to 2, 3 to 3 etc.). Such extension cables may be up to 10 metres long. Most keyboards and mice will also work with a 20 metre extension cable.

A4. Remote controller extension cables

The remote controller is supplied as standard with a 3 metre long lead. This distance may be extended with the use of suitable shielded extension cable. This extension cable may be up to 20 metres long and should be wired so that all pins are connected straight through (1 to 1, 2 to 2, 3 to 3 etc.). Remote controllers with longer leads are also available from your supplier.

Appendix B. Problem Solving

Problem:

Peripherals hang after the LINDY CPU Switch USB's channel is changed.

Action:

Ensure that you are using a suitable operating system (see section 2.1). Operating systems such as versions of Mac OS earlier than 8.6 are known to have associated problems. Ensure that you are not reading from or writing to USB connected disk drives whilst you are switching between computers. Ensure that the enumeration guard time is longer than the longest observed enumeration delay (see section 2.4.1) or ensure that you are not switching between computers during the enumeration process.

Problem:

Video is fuzzy or smudged.

Action:

Ensure that you are using high quality tri-coax video cables. These can be easily identified as they are roughly the same thickness as a monitor's video cable and often are lightly fluted on the outside of the cable. Use the minimum possible length of video cables.

Problem:

The on/off key on a Macintosh keyboard doesn't work.

Action:

Ensure that you have plugged the keyboard into port A and that there are not any USB hubs connected between the computer and the LINDY CPU Switch USB.

Problem:

The enumeration delay time seems too long.

Action:

Set the lowest enumeration guard time and remember not to switch away from a selected computer until the timer or hourglass indicates the end of the enumeration process.

Free Manuals Download Website

<http://myh66.com>

<http://usermanuals.us>

<http://www.somanuals.com>

<http://www.4manuals.cc>

<http://www.manual-lib.com>

<http://www.404manual.com>

<http://www.luxmanual.com>

<http://aubethermostatmanual.com>

Golf course search by state

<http://golfingnear.com>

Email search by domain

<http://emailbydomain.com>

Auto manuals search

<http://auto.somanuals.com>

TV manuals search

<http://tv.somanuals.com>