



# CPU SWITCH



## LINDY CPU Switch Smart SUN-MAC-PC Installation and Use

---

Part	Model
32251	LINDY CPU Switch Smart SUN-MAC-PC

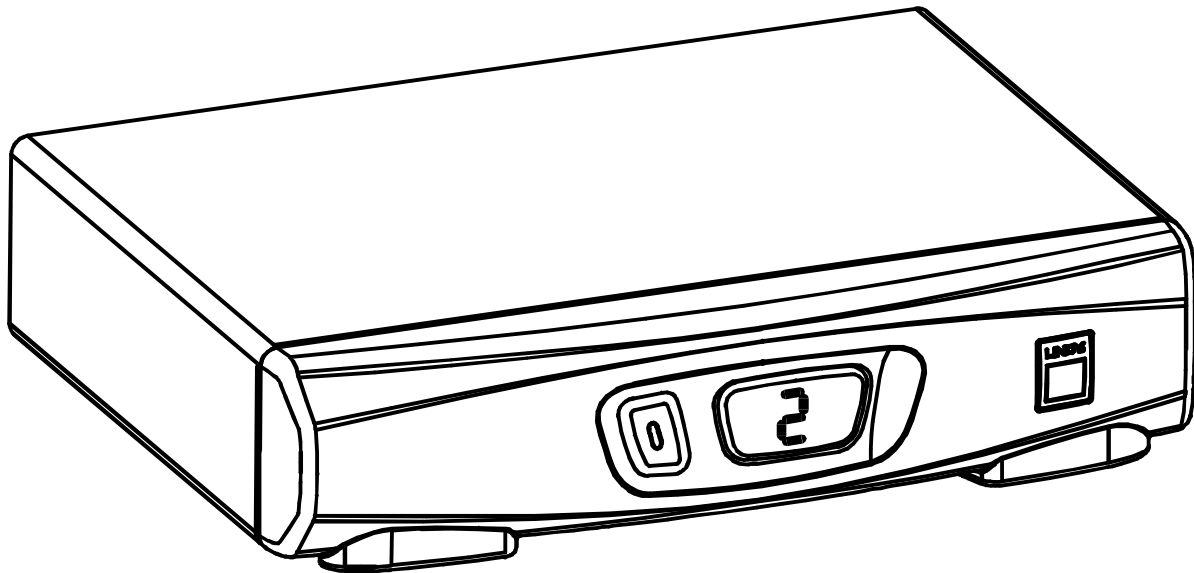

CPU Switch Smart - Installation and Use

First Edition (January 2002)

Part Number 32251

© 2002 LINDY Electronics Ltd.

---

© LINDY ELECTRONICS LIMITED



## Quick Installation and Operation Guide

---

### QUICK INSTALLATION

- Power off all your computers and connect them to the ORANGE ports on the rear of the CPU Switch Smart SUN-MAC-PC. LINDY 3-in-1 keyboard/video/mouse combination cables are recommended for convenience.
- Connect your keyboard, monitor and mouse to the GREY port on the rear of the CPU Switch Smart.

### OPERATION GUIDE SUMMARY

- The CPU Switch Smart's default configuration is suitable for most systems.
- A computer may be selected using the front panel key, a three button mouse or a keyboard hotkey combination. To select a computer using the mouse press and release the left or right hand buttons whilst holding down the central button. To select a computer using the keyboard hotkeys hold down the CTRL and ALT keys, press and release the required port key (e.g. 1) and then release the CTRL and ALT keys.

## Safety information

---

- For use in dry, oil free indoor environments only.
- Do not attempt to service the CPU Switch Smart SUN-MAC-PC yourself.
- Follow all warnings and instructions marked on the CPU Switch Smart SUN-MAC-PC, its optional power adapter and its accessories.
- Warning - live parts contained within optional power adapter.
- No user serviceable parts within optional power adapter - do not dismantle.
- Replace the optional power adapter with a manufacturer approved type only.
- If you use a power extension cord with the CPU Switch Smart SUN-MAC-PC, make sure the total ampere rating of the devices plugged into the extension cord does not exceed the cord's ampere rating. Also, make sure that the total ampere rating of all the devices plugged into the wall outlet does not exceed the wall outlet's ampere rating.

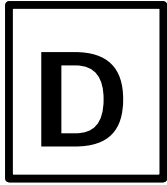

# Kurzanleitung Installation & Betrieb

## EIGENSCHAFTEN

Am **LINDY CPU Switch SMART SUN-MAC-PC** können auch im gemischten Betrieb **Rechner aus verschiedenen Welten** gleichzeitig betrieben werden. So können sowohl **SUN** Rechner mit Mini-DIN-8 Tastatur/Maus (sowie mit zukünftigen USB Schnittstellen) und VGA (HD-15 oder 13W3) Anschluss betrieben werden, wie auch gleichzeitig **PCs** mit USB, PS/2 und VGA sowie moderne **MACs** mit USB und VGA.

Auf der Eingabeseite (Bedienkonsole, Arbeitsplatz) finden Tastaturen und Mäuse aus der PC-Welt (PS/2 Maus/Tastatur, SVGA Monitor) sowie aus der SUN Welt (SUN Tastatur, Maus, SUN SVGA Monitor) Anschluss.

Der LINDY CPU Switch SMART SUN-MAC-PC unterstützt die **Audioanschlüsse** aller angeschlossenen Rechnersysteme für Lautsprecher und Mikrofon in **Voll-Stereo**.

Er unterstützt Monitorauflösungen bis **1900x1440** bis 75Hz sowie DDC Monitorerkennung. Der LINDY CPU Switch benötigt bei Kabellängen unter 5m kein Netzteil. Werden größere Kabellängen benötigt, so sollte ein optional erhältliches Netzteil verwendet werden; hiermit können in den meisten Fällen auch noch Kabellängen bis 20m realisiert werden. Beachten Sie bitte, dass für USB Geräte ab 5m Distanz „Aktivverlängerungen / Active Extension Cable“ (LINDY Art.Nr. 32853 oder 42800) eingesetzt werden müssen.

Der LINDY CPU Switch emuliert für alle angeschlossenen Rechner permanent Monitor, Maus und Tastatur. Dies sorgt dafür, dass zwischen den angeschlossenen Rechnern beliebig oft hin und her geschaltet werden kann, ohne dass die Rechner das Maus- bzw. Tastatursignal verlieren und neu gebootet werden müssen.

## KURZANLEITUNG INSTALLATION

Schalten Sie alle anzuschliessenden Computer aus und schliessen Sie sie an die **ORANGEFARBENEN** Ports auf der Rückseite des CPU Switch SMART SUN-MAC-PC an. Der Rechneranschluss kann nur über Systemkabel erfolgen (LINDY Art.Nr.n in Klammern):  
PS/2-SVGA-Audio: 2m (32951), 5m (32953)

USB-SVGA-Audio: 2m (32955), 5m (32957)

SUN-SVGA-Audio: 2m (32961), 5m (32963)

Sollten größere Kabellängen benötigt werden, so empfehlen wir die Verwendung der LINDY 3-in-1 Kombi-Tastatur/Video/Maus-Verlängerungskabel sowie bei Bedarf LINDY Audio-Verlängerungskabel. Verwenden Sie in diesen Fällen das optionale Netzteil falls Probleme auftreten.

Serielle PC-Mausanschlüsse (COM-Port, Sub-D-9) werden nur mit dem korrekten Mausadapter (z.B. LINDY Art.Nr. 70058) unterstützt (nähere Angaben im ausführlichen englischen Handbuch).

Schließen Sie Ihre Tastatur, Monitor, Maus, Lautsprecher und Mikrofon an den **GRAUEN** Ports auf der Rückseite des CPU Switch SMART an.

## ZUSAMMENFASSUNG DES HANDBUCHES

Die Voreinstellungen (Defaultkonfiguration) des CPU Switch SMART ist für die meisten Einsatzzwecke geeignet. Der CPU Switch SMART SUN-MAC-PC kann über die angeschlossenen Rechner mit Strom versorgt werden. Beim Anschluss mehrerer Rechner wird die Stromentnahme auf alle Rechner verteilt, so dass auch das Abschalten einzelner Rechner kein Problem darstellt.

Der Computer, auf dem gearbeitet werden soll, kann auf verschiedene Arten ausgewählt werden: entweder durch Drücken der **Kanalwahltaste** auf der Frontblende, durch Drücken einer **Hotkey-Tastenkombination** auf der Tastatur oder durch eine **3-Tasten-Maus**.

Um einen Computer per Tastatur-Hotkey auszuwählen werden die Strg und ALT Tasten sowie die erforderliche Port-Taste (z.B. 1 ) gleichzeitig gedrückt.

Zum Umschalten zwischen den angeschlossenen Rechnern mit der Maus müssen die mittlere Taste der Maus und gleichzeitig die linke oder rechte Taste kurz gedrückt werden.

Der LINDY CPU Switch SMART SUN-MAC-PC bietet die Möglichkeit, viele integrierte Optionen wie Umschalt-Hotkey, Bildschirmschoner, Passwort, AutoScan-Modus, SUN-Tastatur-Einstellung weitgehend zu konfigurieren. Informationen hierzu finden Sie im ausführlichen englischen Handbuch.

Weitere Hinweise finden Sie dort auch zu den Themen:

Problembehebung

Kaskadierung mehrerer CPU Switches

Hot-Plugging von Rechnern am CPU Switch

Einstellungen für das Mausprotokoll

Mouse Recovery nach Verlust des PS/2 Maussignals an einem der angeschlossenen PC

Mouse Recovery nach Abziehen der Maus vom CPU Switch

Flash-Upgrade der Firmware

## Sicherheitstechnische Informationen

Nur für den Gebrauch innerhalb von trockenen Räumen vorgesehen.

Die Wartung des CPU Switch SMART SUN-MAC-PC darf ausschließlich von dazu qualifiziertem Fachpersonal vorgenommen werden.

Sämtliche Warnhinweise und Anweisungen auf dem CPU Switch SMART SUN-MAC-PC, seinem Netzteil und Zubehörteilen sind zu beachten und befolgen.

Warnung – im Netzteil sind unter Spannung stehende Teile enthalten, es darf nicht geöffnet werden.

Das Netzteil darf nur durch ein von LINDY zugelassenes ersetzt werden.

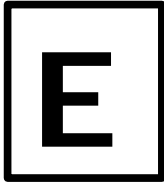

# Guía rápida de instalación y funcionamiento

---

## INSTALACIÓN RÁPIDA

- Desconecte todos los ordenadores y conéctelos a los puertos NARANJA en la parte posterior del CPU Switch Smart SUN-MAC-PC. Para mayor comodidad se recomiendan cables combinados 3-en-1 teclado/vídeo/ratón.
- Conecte el teclado, el monitor y el ratón al puerto GRIS en la parte posterior del CPU Switch Smart.

## RESUMEN DE LA GUÍA DE FUNCIONAMIENTO

- La configuración por defecto del CPU Switch Smart es adecuada para la mayoría de los sistemas.
- Puede seleccionarse un ordenador utilizando la tecla del panel frontal, un ratón de tres botones o una combinación de teclas rápidas en el teclado. Para seleccionar un ordenador utilizando el ratón, pulse y suelte los botones izquierdo o derecho mientras mantiene pulsado el botón del medio. Para seleccionar un ordenador utilizando las teclas rápidas del teclado, mantenga pulsadas las teclas CTRL y ALT, pulse y suelte la tecla del puerto requerida (p.e. 1) y a continuación suelte las teclas CTRL y ALT.

## Información sobre seguridad

---

- Solamente debe usarse en interiores, en entornos secos y sin grasa.
- No intente realizar ningún tipo de mantenimiento al CPU Switch Smart SUN-MAC-PC usted mismo.
- Siga todos los avisos e instrucciones marcadas en el CPU Switch Smart SUN-MAC-PC, el adaptador de potencia opcional y todos sus accesorios.
- Aviso – el adaptador de potencia opcional tiene piezas con tensión.
- El adaptador de potencia opcional no contiene piezas que pueda mantener el usuario – no desmontarlo.
- Cambie el adaptador de potencia opcional solamente con un tipo aprobado por el fabricante.
- Si utiliza un cable de extensión con el CPU Switch Smart SUN-MAC-PC, compruebe que el amperaje nominal total de los equipos enchufados en el cable de extensión no superen el amperaje nominal del cable de extensión. Asimismo, compruebe que el amperaje nominal total de todos los equipos conectados a la toma de red no superen el amperaje nominal de la toma.

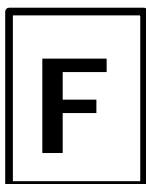

# Guide d'installation rapide et mode d'emploi

---

## INSTALLATION RAPIDE

- Mettez tous vos ordinateurs hors tension et raccordez-les aux ports ORANGE à l'arrière du CPU Switch Smart SUN-MAC-PC. Les câbles clavier/vidéo/souris LINDY 3-in-1 sont recommandés pour des raisons pratiques.
- Raccordez votre clavier, moniteur et souris au port GRIS à l'arrière du CPU Switch Smart.

## MODE D'EMPLOI SOMMAIRE

- La configuration par défaut du CPU Switch Smart convient à la plupart des systèmes.
- Pour sélectionner un ordinateur, utilisez la touche du panneau avant, une souris à trois boutons ou une combinaison de touches de raccourci clavier. Pour sélectionner un ordinateur à l'aide de la souris, maintenez la pression sur le bouton central et appuyez sur le bouton gauche ou droite avant de relâcher. Pour sélectionner un ordinateur avec les touches de raccourci clavier, maintenez les touches CTRL et ALT enfoncées, appuyez sur la touche du port souhaité (ex. 1) et relâchez, puis relâchez les touches CTRL et ALT.

## Consignes de sécurité

---

- A n'utiliser qu'à l'intérieur, dans un environnement sec et exempt d'huile.
- Ne pas assurer soi-même l'entretien du CPU Switch Smart SUN-MAC-PC.
- Observer tous les avertissements et instructions marqués sur le CPU Switch Smart SUN-MAC-PC, son adaptateur de courant optionnel et ses accessoires.
- Avertissement – l'adaptateur de courant optionnel renferme des pièces sous tension.
- L'adaptateur de courant optionnel ne contient aucune pièce devant être révisée par l'utilisateur – ne pas le démonter.
- Ne remplacer l'adaptateur de courant optionnel que par un adaptateur approuvé par le fabricant.
- Lorsqu'une rallonge est utilisée pour le CPU Switch Smart SUN-MAC-PC, vérifier que l'intensité nominale totale des périphériques branchés sur la rallonge ne dépasse pas l'intensité nominale du câble. Par ailleurs, vérifier que l'intensité nominale totale de tous les périphériques branchés sur la prise murale ne dépasse pas l'intensité nominale de la prise murale elle-même.

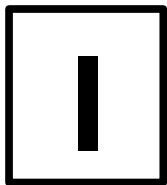

# Guida di installazione rapida e funzionamento

---

## INSTALLAZIONE RAPIDA

- Spegnere tutti i computer e collegarli alle porte ARANCIONI sul retro dell'CPU Switch Smart SUN-MAC-PC. Per facilità consigliamo i cavi LINDY combinati 3-in-1 tastiera/video/mouse.
- Collegare la tastiera, monitor e mouse alla porta GRIGIA sul retro dell'CPU Switch Smart.

## SOMMARIO GUIDA OPERATIVA

- La configurazione di default dell'CPU Switch Smart è adatta alla maggior parte dei sistemi.
- Si può selezionare un computer usando il tasto sul pannello frontale, un mouse a tre bottoni o una tastiera con tasti attivi. Per selezionare un computer con il mouse, premere e rilasciare i bottoni sinistro o destro trattenendo contemporaneamente quello centrale. Per selezionare un computer con tasti attivi tastiera, tener premuti i tasti CTRL e ALT, premere e rilasciare il tasto porta richiesta (es. 1) e quindi rilasciare i tasti CTRL e ALT.

## Informazioni riguardanti la sicurezza

---

- Da usare esclusivamente in interni asciutti e privi di olio.
- Non cercare di effettuare manutenzione sull'CPU Switch Smart SUN-MAC-PC.
- Seguire tutti gli avvertimenti ed istruzioni presenti sull'CPU Switch Smart SUN-MAC-PC, sull'adattatore opzionale di potenza e sugli accessori.
- Attenzione – l'adattatore opzionale di potenza contiene parti sotto tensione.
- L'adattatore opzionale di potenza non contiene parti soggette a manutenzione da parte dell'utente – non smontarlo.
- Sostituire l'adattatore opzionale di potenza solo con uno di tipo approvato dal produttore.
- Se si usa una prolunga con l'CPU Switch Smart SUN-MAC-PC, controllare che la potenza nominale totale in ampère dei dispositivi collegati alla prolunga non superi la potenza nominale in ampère della prolunga stessa. Controllare inoltre che la potenza nominale totale in ampère dei dispositivi collegati non superi la potenza nominale in ampère della presa a muro.

---

## CPU Switch Smart SUN-MAC-PC

# About this manual

---

CPU Switch Smart SUN-MAC-PC - Installation and Use

First edition (January 2002)

Part No. 32251

(c) 2002 LINDY

**www.LINDY.com**

All rights reserved. Whilst every precaution has been taken in the preparation of this manual, LINDY assumes no responsibility for errors or omissions. Neither is any liability assumed for damages resulting from the use of the information contained herein. We reserve the right to change the specifications, functions and circuitry of the product without notice. All trademarks acknowledged.

## Safety information

---

- For use in dry, oil free indoor environments only.
- Do not attempt to service the CPU Switch Smart SUN-MAC-PC yourself.
- Follow all warnings and instructions marked on the CPU Switch Smart SUN-MAC-PC, its optional power adapter and its accessories.
- Warning - live parts contained within optional power adapter.
- No user serviceable parts within optional power adapter - do not dismantle.
- Replace the optional power adapter with a manufacturer approved type only.
- If you use a power extension cord with the CPU Switch Smart SUN-MAC-PC, make sure the total ampere rating of the devices plugged into the extension cord does not exceed the cord's ampere rating. Also, make sure that the total ampere rating of all the devices plugged into the wall outlet does not exceed the wall outlet's ampere rating.



# Warranty

---

LINDY warrants that this product shall be free from defects in workmanship and materials for a period of three years from the date of original purchase. If the product should fail to operate correctly in normal use during the warranty period, LINDY will replace or repair it free of charge. No liability can be accepted for damage due to misuse or circumstances outside LINDY's control. Also LINDY will not be responsible for any loss, damage or injury arising directly or indirectly from the use of this product. LINDY's total liability under the terms of this warranty shall in all circumstances be limited to the replacement value of this product.

If any difficulty is experienced in the installation or use of this product that you are unable to resolve, please contact your supplier.

# Trademarks

---

All trademarks mentioned in this manual are acknowledged to be the property of the respective trademark owners.

Compaq is a registered trademark of Compaq Computer Corporation.

Hewlett-Packard is a registered trademark of Hewlett-Packard.

IBM, PC/AT, PS/2, RS/6000 and ThinkPad are registered trademarks of International Business Machines Corporation.

Logitech, MouseMan+ and Pilot Mouse+ are trademarks of Logitech Inc.

Microsoft and Windows are registered trademarks, and IntelliMouse is a trademark of Microsoft Corporation.

Velcro is a trademark of Velcro USA Inc.

# Radio Frequency Energy

---

Shielded cables must be used with this equipment to maintain compliance with radio frequency energy emission regulations and ensure a suitably high level of immunity to electromagnetic disturbances.

## **European EMC directive 89/336/EEC**

This equipment has been tested and found to comply with the limits for a class A computing device in accordance with the specifications in the European standard EN55022. These limits are designed to provide reasonable protection against harmful interference. This equipment generates, uses and can radiate radio frequency energy and if not installed and used in accordance with the instructions may cause harmful interference to radio or television reception. However, there is no guarantee that harmful interference will not occur in a particular installation. If this equipment does cause interference to radio or television reception, which can be determined by turning the equipment on and off, the user is encouraged to correct the interference with one or more of the following measures: (a) Reorient or relocate the receiving antenna. (b) Increase the separation between the equipment and the receiver. (c) Connect the equipment to an outlet on a circuit different from that to which the receiver is connected. (d) Consult the supplier or an experienced radio / TV technician for help.



## **FCC Compliance Statement (United States)**

This equipment generates, uses and can radiate radio frequency energy and if not installed and used properly, that is, in strict accordance with the manufacturer's instructions, may cause interference to radio communication. It has been tested and found to comply with the limits for a class A computing device in accordance with the specifications in Subpart J of part 15 of FCC rules, which are designed to provide reasonable protection against such interference when the equipment is operated in a commercial environment. Operation of this equipment in a residential area may cause interference, in which case the user at his own expense will be required to take whatever measures may be necessary to correct the interference. Changes or modifications not expressly approved by the manufacturer could void the user's authority to operate the equipment.

## **Canadian Department of Communications RFI statement**

This equipment does not exceed the class A limits for radio noise emissions from digital apparatus set out in the radio interference regulations of the Canadian Department of Communications.

Le présent appareil numérique n'émet pas de bruits radioélectriques dépassant les limites applicables aux appareils numériques de la classe A prescrites dans le règlement sur le brouillage radioélectriques publié par le ministère des Communications du Canada.

# Contents

---

<b>1. Introduction.....</b>	<b>6</b>
1.1 Key features.....	6
1.2 Package contents .....	8
1.3 Remote controller contents.....	8
1.4 Product information .....	9
<b>2. Installation.....</b>	<b>11</b>
2.1 What you will need .....	11
2.2 Mounting the CPU Switch Smart SUN-MAC-PC .....	13
2.3 Connecting your devices .....	13
2.4 'Interface powered' operation without the optional power adapter .....	16
2.5 Configuring your PCs .....	16
2.6 Configuring the CPU Switch Smart SUN-MAC-PC .....	16
2.7 Summary of CPU Switch Smart SUN-MAC-PC configuration options....	18
2.8 Resetting the CPU Switch Smart SUN-MAC-PC without disconnecting your devices.....	20
2.9 Other useful installation information .....	20
2.10 Re-enabling a disconnected PS/2 mouse .....	21
2.11 Hot plugging the CPU Switch Smart SUN-MAC-PC into running systems and re-enabling disconnected PS/2 CPU mouse connections .....	21
2.12 Upgrading the CPU Switch Smart's flash memory .....	23
<b>3. Using the CPU Switch Smart SUN-MAC-PC .....</b>	<b>28</b>
3.1 Power on status.....	28
3.2 Front panel keys and remote controller .....	28
3.3 Status display .....	29
3.4 Keyboard hotkey control.....	30
3.5 Mouse control .....	31

## 4. CPU Switch Smart SUN-MAC-PC configuration options ..... 32

4.1 Screen saver time delay .....	32
4.2 Autoscan lock on mode and delay time .....	32
4.3 Mouse mode and mouse switching of channels .....	33
4.4 Keyboard hotkey combination .....	35
4.5 Cycling between all channels or just the active channels .....	35
4.6 Firmware functions (version query, mouse restore and reset) .....	35
4.7 Setting a security password .....	36
4.8 Cascade query code .....	37
4.9 Resolving slow mouse problems .....	37
4.10 Sun keyboard type .....	38
4.11 Using the Sun keyboard's "hot media" keys to select computers .....	38
4.12 Customising the Sun keyboard operation to force the generation of a £ .....	38
4.13 Exit configure mode .....	39

## Appendices

A - Cable and connector specifications .....	40
B - Problem solving .....	46

# 1. Introduction

---

Thank you for purchasing the CPU Switch Smart SUN-MAC-PC. Your CPU Switch Smart SUN-MAC-PC is a very high performance multi-platform keyboard, monitor and mouse sharing device which supports a wide range of computer hardware and software platforms. Stereo speaker and microphone connections add further to the CPU Switch Smart's versatility by enabling you to control several multimedia computers from a single console. Your CPU Switch Smart intelligently handles the conversions between various hardware standards so that you can use a single keyboard and mouse of your choice to control a diverse mixture of computers. A range of useful features and functions have been provided to enhance the ease of use of this product and we trust that you will enjoy using it.

## 1.1 Key features

- Control multiple computers from a single console (keyboard, mouse, monitor, stereo speakers and microphone).
- Connects to computers with Sun (8-pin) or PC (6-pin) style keyboard and mouse connections.
- SPU models also connect to computers with USB keyboard and mouse connections.
- All models support Sun or PC style keyboards and mice.
- Automatic "seamless" conversion between different hardware platforms.
- Channel switching by front panel key, keyboard hotkey, 3 button mouse or Sun keyboard "hot media" keys.
- "All-in-one" colour coded cables provide a very neat installation with excellent video quality.
- Supports a very wide range of software including Windows<sup>®</sup> 3.X, WFWG, 95, 98, 2000, ME, XP, NT, DOS, Unix, Linux<sup>®</sup>, Novell<sup>®</sup> NetWare<sup>®</sup>, OS/2, BSD, Solaris, Mac OS (8.6 and higher).
- Automatic detection of the connected hardware.

- Continuous keyboard and mouse emulation on all ports ensures problem free computer bootup.
- On SPU models, continuous USB device emulation ensures reliable and quick switching without having to wait several seconds for the USB bus to enumerate.
- Interface powered operation – CPU Switch Smart SUN-MAC-PC draws its power from the connected computers for maximum convenience.
- Intelligent switching feature enables users to switch between all ports or just the active ports.
- Stereo audio and microphone support makes MP ideal for multimedia applications.
- "Clickless" audio switching ensures that the speakers don't "thump" every time that you switch channels.
- Supports high bandwidth monitors at resolutions up to 1900 x 1440 with an excellent video transfer characteristic - high bandwidth and low distortion.
- RS232 mice supported as standard.
- Flash upgradeable - CPU Switch Smart SUN-MAC-PC's firmware may be upgraded by connecting a computer's serial port and running a download program.
- Video channels support Display Data Channel (DDC/DDC1/DDC2) signalling.
- Password security prevents unauthorised use.
- User options stored in EEPROM memory.
- Remote control module for convenient operation.
- Sun keyboard remap feature to force generation of £ key.
- Automatically restores keyboard and mouse states when channel changed.
- Supports mouse prompt and stream modes for maximum compatibility.
- Includes screen saver, auto-scan and variable hotkey options.
- Supports Microsoft IntelliMouse and other common wheel mice.
- Allows mixtures of controlling devices such as a Sun keyboard with a PC style PS/2 mouse.
- Mouse restoration functions to enable 'hot plugging' of certain systems.

- Keyboard, mouse and CPU Switch Smart SUN-MAC-PC resets may be performed without disconnecting devices.
- Supports IBM ThinkPad 'Y' cables.
- Power and activity indication confirm correct operation.
- All ports are active simultaneously – all computers may all be booted at the same time.
- Keyboard data flowing through the CPU Switch Smart is kept in its "native" format which enables the additional keys on enhanced keyboards to be supported.
- Robust metal case ensures good shielding and video quality.
- All models support desktop and laptop PCs, Sun (8-pin style), RS6000s, DEC Alphas, and Silicon Graphics.
- SPU models additionally support Sun (USB style), desktop and laptop PCs (USB style) and Apple (USB style).
- Optional power adapter can be used for 'video only' or cascade applications.

## 1.2 Package contents

- CPU Switch Smart SUN-MAC-PC.
- This installation guide.
- (Please note that a power adapter is NOT required for most applications and so is not included. This may be purchased separately if required -  
 part code:32290 IEC Power Adaptor with UK Mains Lead  
 part code:32265 IEC Power Adaptor with US Mains Lead  
 part code:32263 IEC Power Adaptor with Schuko Mains Lead part  
 code:32274 Wall Mount Power Adaptor with Euro Plug)

## 1.3 Remote controller contents (part code: 32255)

- Remote control module.
- Velcro strip for mounting remote controller.

## 1.4 Product information

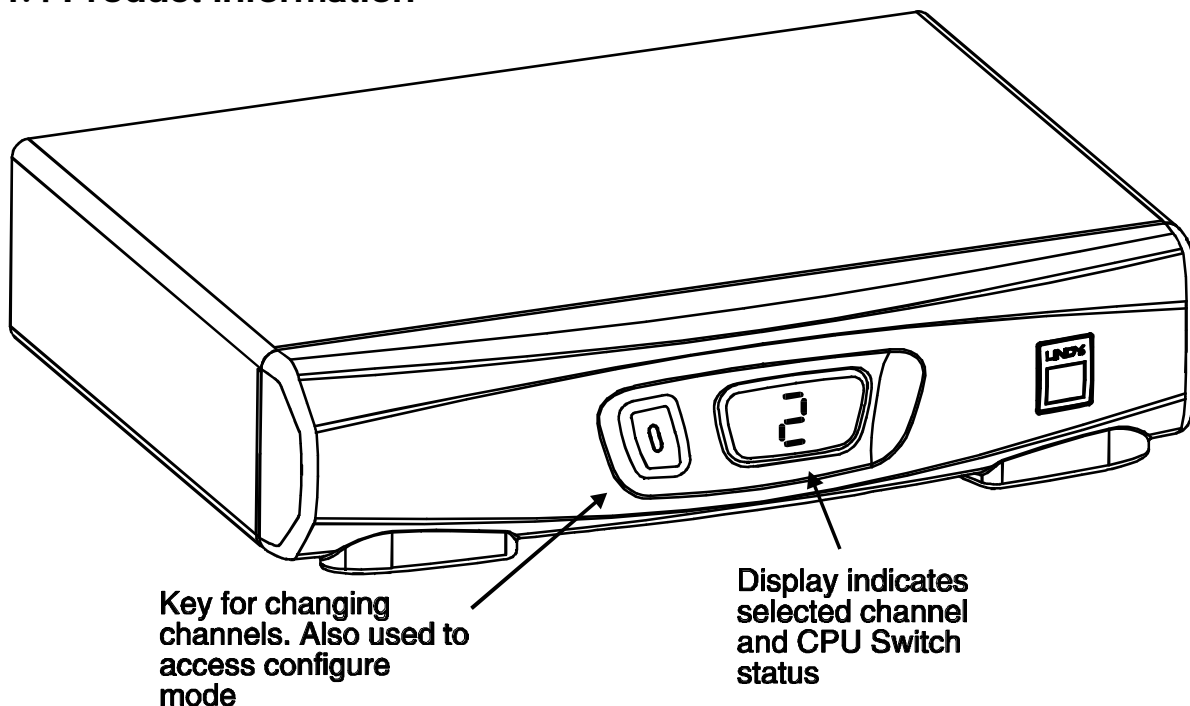

Figure 1 - CPU Switch Smart SUN-MAC-PC front view

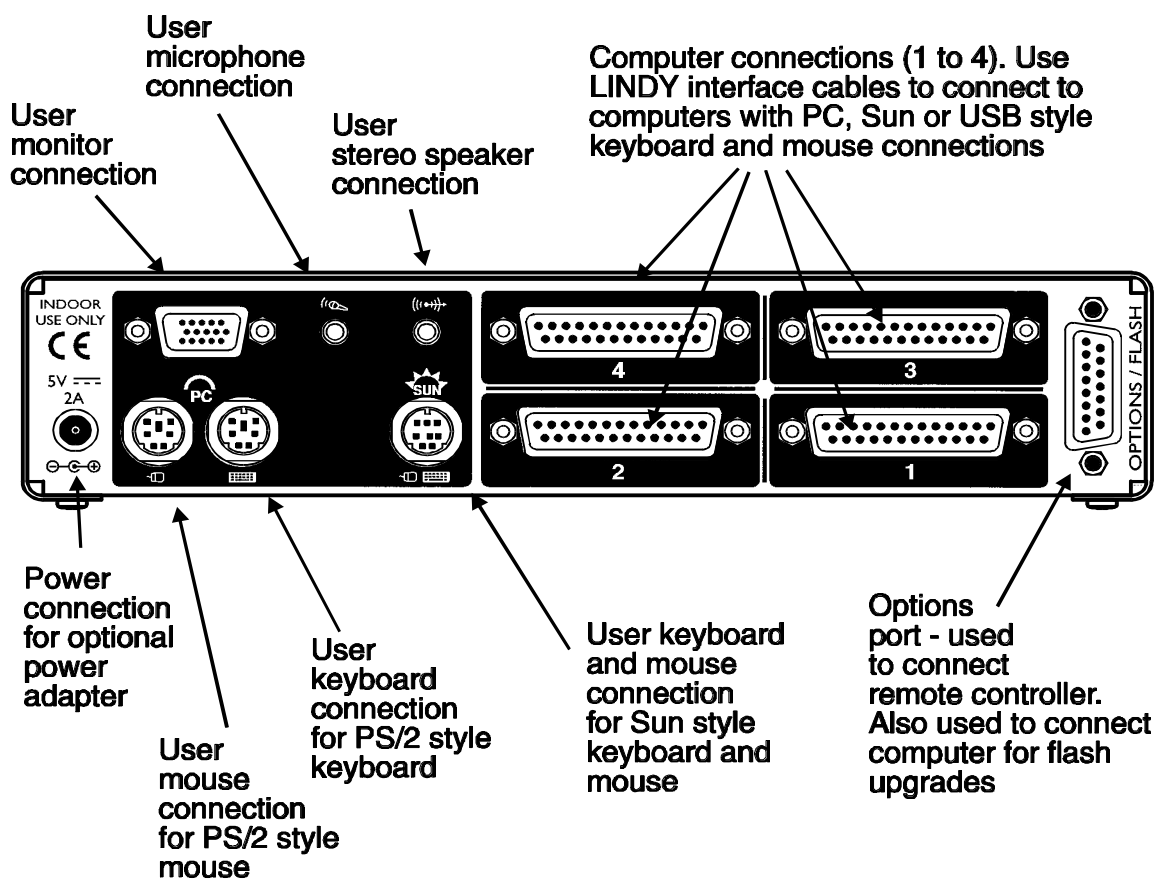

Figure 2 - CPU Switch Smart SUN-MAC-PC rear view



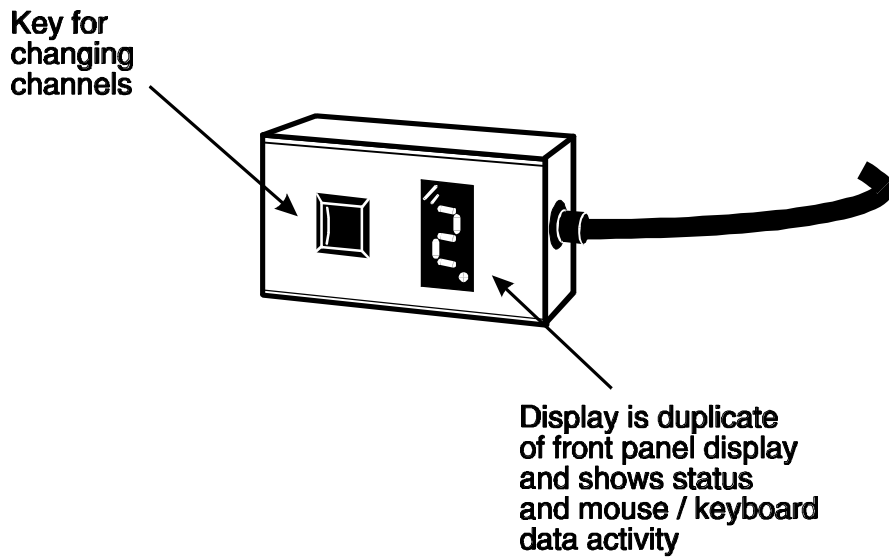

Figure 3 - Remote control pad / display (optional accessory)

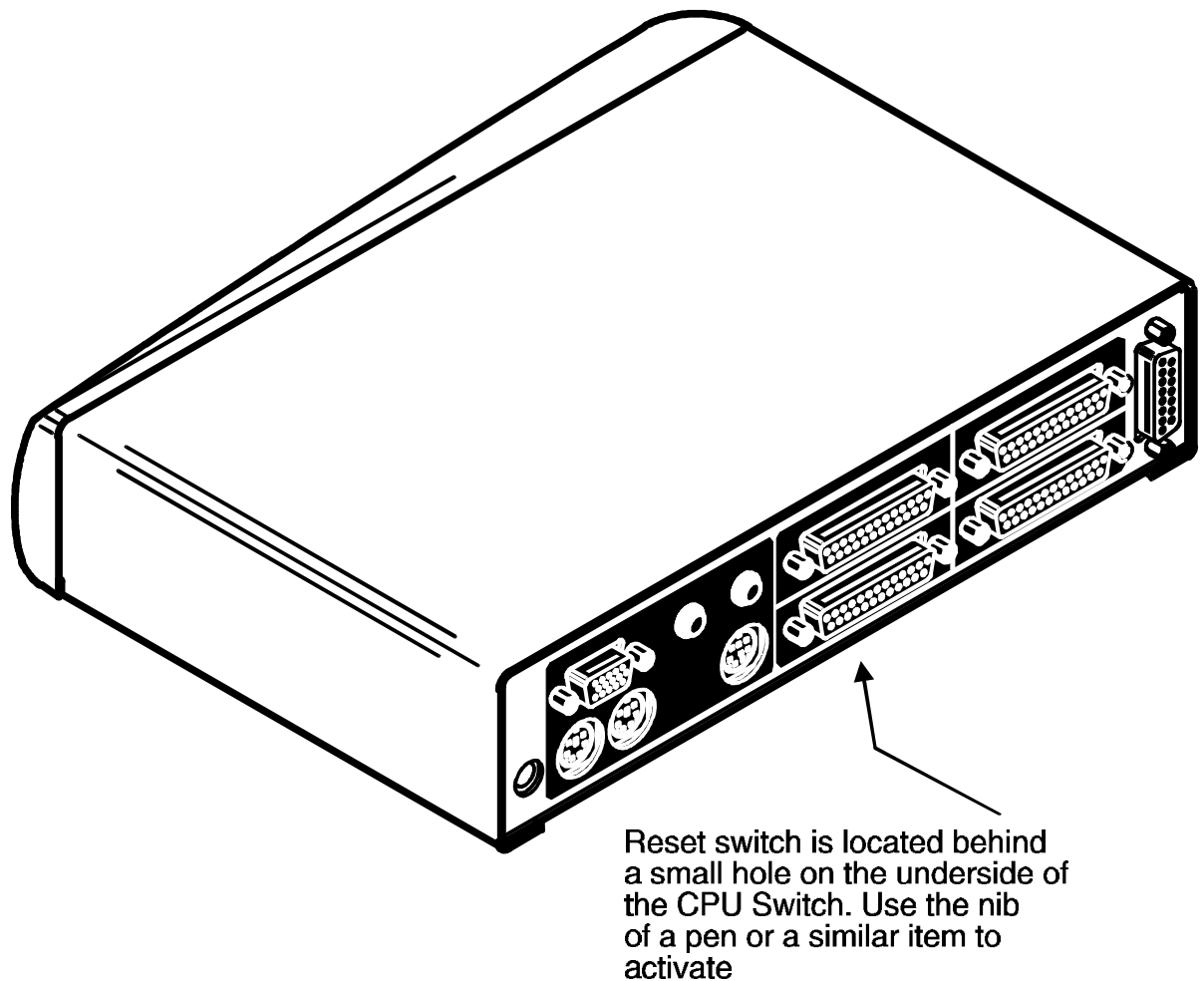

Figure 4 - Rear view of CPU Switch Smart SUN-MAC-PC

## 2. Installation

---

### 2.1 What you will need

- Cables to connect the CPU Switch Smart SUN-MAC-PC to each of your computers. These cables are specially constructed for use with the CPU Switch Smart SUN-MAC-PC and may be purchased from your CPU Switch Smart SUN-MAC-PC supplier. Cable specifications and part codes are given in appendix A.
  
- A suitable keyboard. Supported types are:
  - 1) A Sun keyboard with an 8 pin mini-DIN connector (recommended if you are going to connect any Sun computers to the MP).
  - 2) A standard PC style keyboard with a 6 pin mini-DIN PS/2 style connector.
  - 3) A standard PC style keyboard with a 5 pin DIN connector and an AT to PS/2 keyboard adapter (5 pin DIN to 6 pin mini-DIN)
  
- A suitable mouse. If you wish to use the mouse to switch the CPU Switch Smart SUN-MAC-PC's channel then you will need a three button mouse or an IntelliMouse. Supported types are:
  - 1) A standard PC style two or three button Microsoft or Logitech compatible mouse or a Microsoft IntelliMouse compatible mouse with a 6-pin mini-DIN connector.
  - 2) A Sun mouse of the type that plugs into the Sun keyboard. This should have an 8 pin mini-DIN connector.
  
- A monitor with a standard VGA/SVGA (15 pin) connector that will work when connected directly to each of your computers. CPU Switch Smart SUN-MAC-PC supports low and high resolution monitors. If you have a monitor with a 13 pin 13W3 connector of the type that was traditionally used to connect to older Sun computers then you will need an adapter to convert this to the 15 pin format - please contact your CPU Switch Smart SUN-MAC-PC supplier.

● You may also need one or more of the following adapters. These adapters may be obtained from your CPU Switch Smart SUN-MAC-PC supplier and other good retailers.

**Video adapter - 13W3 male connector to 15 pin D-type connector**

(LINDY part code: 70127)

If you have a Sun computer with an older style 13W3 video connector then you will need an adapter to convert this to the 15 way D-type format.

**Keyboard adapter - 6 pin mini-DIN female to 5 pin standard DIN male**

(LINDY part code: 70130)

If you have a PC with an older style 5 pin standard DIN connector then you will need an adapter to convert this to the 6 pin mini-DIN format.

**Mouse adapter - 9 pin D-type female to 6 pin mini-DIN female**

(LINDY part code: 70058)

If you have a PC with an older style RS232 mouse connection then you will need an adapter to convert this to the 6 pin mini-DIN format. There are several specifications of these adapters that are provided with various mice. They all look the same but unfortunately there are several common wiring schemes all of which are different. To ensure that you have the right adapter, either purchase this from your CPU Switch Smart SUN-MAC-PC supplier or check your adapter against the wiring specification given in Appendix A.

● If you are connecting to PCs then you will need a suitable mouse driver.  
Supported types are:

- 1) A PS/2 or RS232 two button mouse driver (any manufacturer).
- 2) Microsoft mouse driver (including IntelliMouse).
- 3) Logitech mouse driver (including two button, three button and wheel mouse).
- 4) A mouse driver that is compatible with the above types (most are).

(The CPU Switch Smart SUN-MAC-PC supports 'Internet Mice' that are compatible with the Microsoft IntelliMouse. These are fitted with a wheel or other scroll control and sometimes have additional buttons. Examples are: Microsoft IntelliMouse, Logitech Pilot Mouse+, Logitech MouseMan+, Genius NetMouse and Genius NetMouse Pro.)

## **Use of PS/2 and RS232 style mice with the CPU Switch Smart SUN-MAC-PC -**

All of the mouse connections from CPU Switch Smart SUN-MAC-PC to PCs support either a PS/2 or an RS232 mouse. CPU Switch Smart SUN-MAC-PC automatically converts from the PS/2 mouse commands to RS232 serial mouse commands. Serial mice types are selected by using an adapter as described in Appendix A. The CPU Switch Smart SUN-MAC-PC will operate without a mouse connected if you do not wish to use one.

## **2.2 Mounting the CPU Switch Smart SUN-MAC-PC**

The CPU Switch Smart SUN-MAC-PC has been designed for use on a desktop or shelf in close proximity to the user's monitor and peripherals. The optional remote controller may be used if you wish to locate the CPU Switch Smart SUN-MAC-PC on a desk or shelf that is some distance from the monitor and peripherals.

## **2.3 Connecting your devices**

Ensure that the optional power adapter is disconnected from the CPU Switch Smart SUN-MAC-PC and that all the devices which are to be attached are switched off. Connect the shared keyboard, mouse, monitor, speakers and microphone to the connectors at the rear of the CPU Switch Smart SUN-MAC-PC (see figs 1, 2 and 3). If you are using a Sun keyboard with an 8 pin DIN connector then plug the keyboard into the MP and the mouse into the keyboard. You may leave any unused ports disconnected if you don't wish to use all these devices.

Next, connect each computer system unit in turn using the LINDY interface cables that you have purchased for use with the CPU Switch Smart SUN-MAC-PC (see Appendix A for cable specifications and part codes). These are colour coded and should connect directly to the various ports on your computers. The three main cable types are shown in figure 5. These cables are available with or without the audio connectors. Any unused computer connections can be left unconnected.

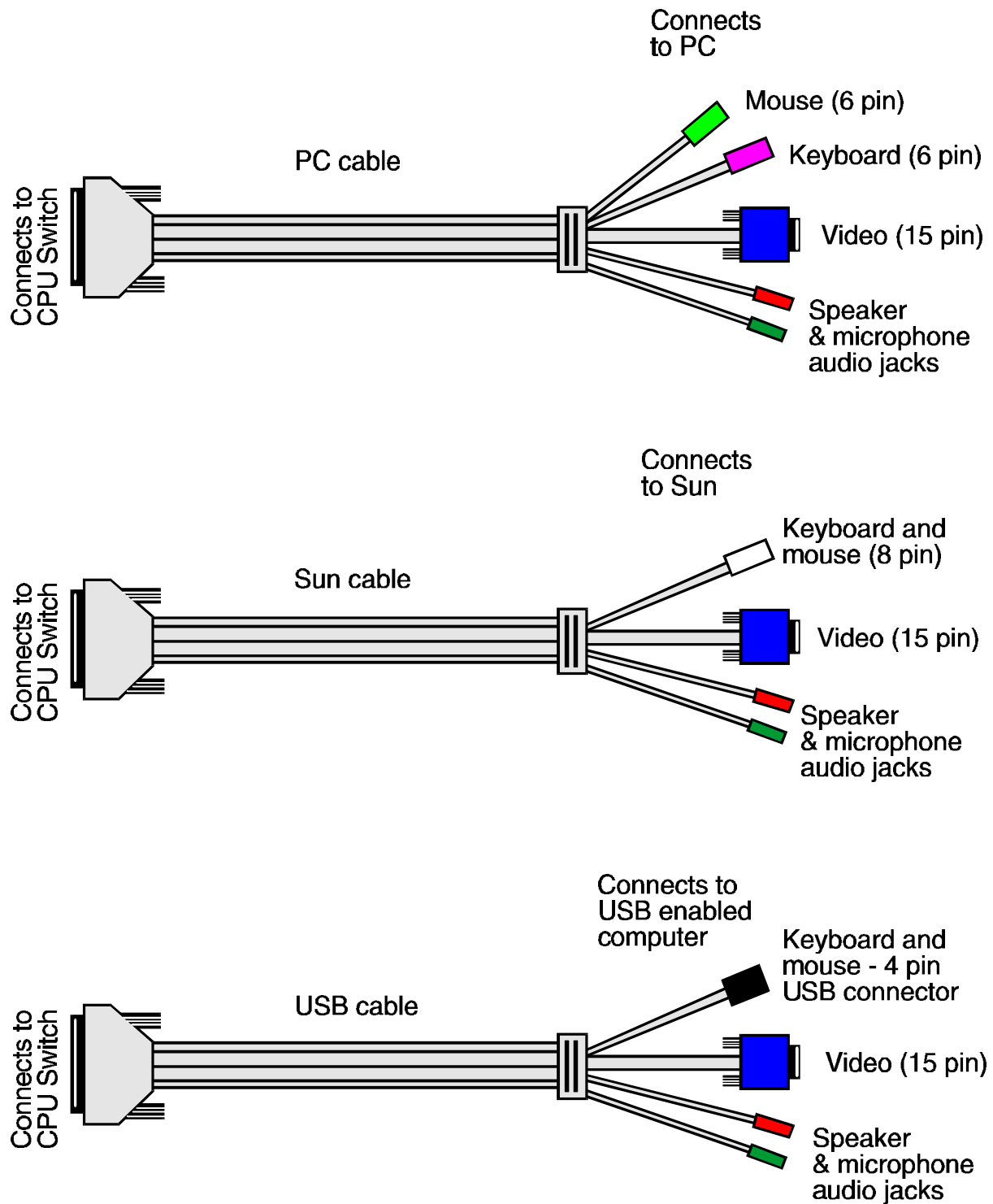
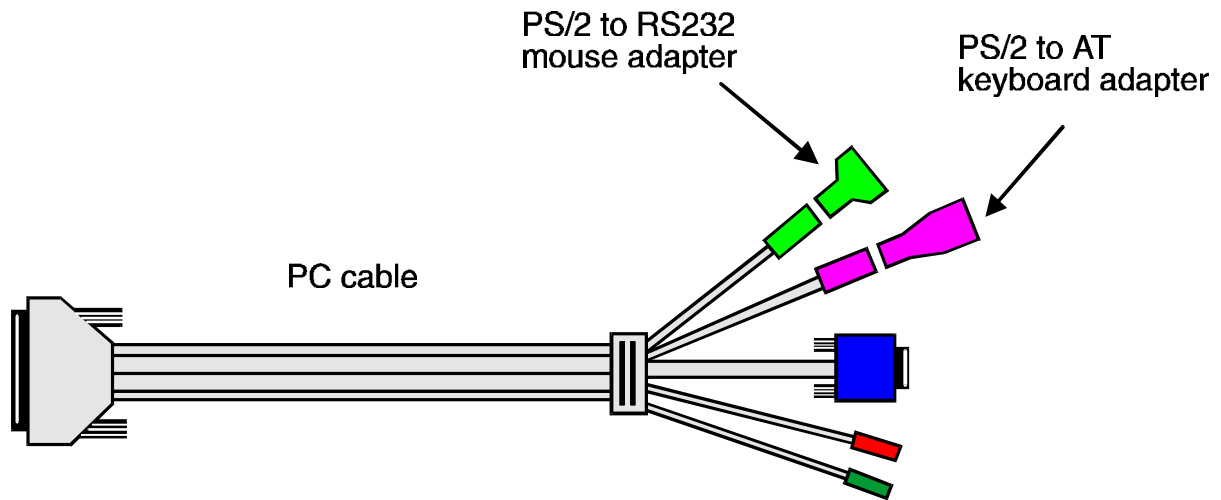

Figure 5 - CPU Switch Smart SUN-MAC-PC cables.

See appendix A for part codes and ordering information

To connect PCs with serial mouse connections and AT style keyboard connections use the PC cable together with the adapters specified in appendix A. If you have an existing 6-pin mini-DIN to 9-pin serial adapter that came with a mouse it may not be suitable for use with the CPU Switch Smart as there are several different standard wiring configurations for these adapters.



To connect Sun computers with older style 13W3 video connections you will need to use the Sun cable together with a 13W3 to 15 way D-type video adapter.

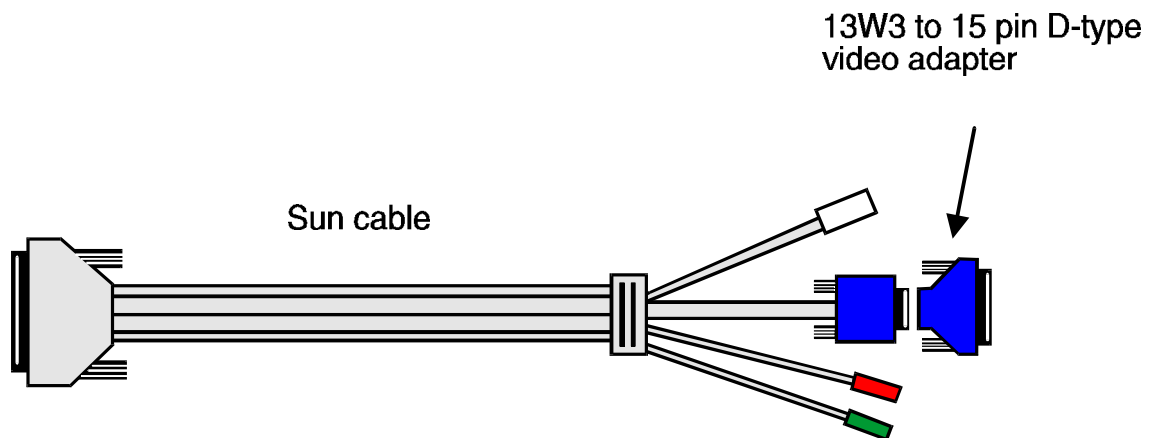

The CPU Switch Smart SUN-MAC-PC is now ready for use and will start to operate as soon as one of the attached PCs is powered on. If you are connecting to PCs using cables that are longer than 5 metres or are cascading the CPU Switch Smart SUN-MAC-PC to another CPU Switch Smart SUN-MAC-PC you will need to use the optional power adapter. When using the optional power adapter, ensure that it is connected to the mains and powering the CPU Switch Smart SUN-MAC-PC before you switch on the connected computers. Failure to switch the CPU Switch Smart SUN-MAC-PC and computers on in the correct order can lead to the mouse and/or keyboard not being recognised by the computers when they are switched on.

## **2.4 'Interface powered' operation without the optional power adapter**

The CPU Switch Smart SUN-MAC-PC draws its power from the connected computers via the keyboard cables. A single keyboard connection is normally sufficient to power the CPU Switch Smart SUN-MAC-PC provided that the cable is no longer than 5 metres. If more than one computer is connected then the power will be intelligently drawn from all computers. Cables longer than 5 metres may be used provided that the CPU Switch Smart SUN-MAC-PC is already powered by another connected computer or the optional power adapter. If you are cascading the CPU Switch Smart SUN-MAC-PC to another CPU Switch Smart SUN-MAC-PC then a power adapter must be connected to all CPU Switch Smart SUN-MAC-PCs.

## **2.5 Configuring your computers**

Configure your computers in the same way that you would if your keyboard, mouse and monitor were all connected directly to your computer. For PCs, the CPU Switch Smart SUN-MAC-PC emulates Microsoft compatible serial, IntelliMouse, and PS/2 mice, so ensure that your PC software is configured for a Microsoft mouse of the correct type. Refer to the list of supported drivers in section 2.1.

## **2.6 Configuring the CPU Switch Smart SUN-MAC-PC**

The CPU Switch Smart SUN-MAC-PC is supplied pre-configured with factory defaults which are suitable for most applications. There are a number of more advanced options which can be set by the user. These are stored in the CPU Switch Smart SUN-MAC-PC's EEPROM memory and are retained when the power is disconnected.

The options may be changed whilst the CPU Switch Smart SUN-MAC-PC is in configure mode. You may enter configure mode at initial power on or whilst the CPU Switch Smart SUN-MAC-PC is running:

### **To enter configure mode at power on:**

Switch off all the attached computers and the CPU Switch Smart SUN-MAC-PC. Hold down the front panel key whilst powering on the CPU Switch Smart SUN-MAC-PC. Remember that the CPU Switch Smart SUN-MAC-PC draws its power from any attached PC via the keyboard cable and so will power itself on when the attached PC is switched on or when the optional power adapter is connected. Do not release the key until the CPU Switch Smart SUN-MAC-PC displays 'u'. Whilst the CPU Switch Smart is displaying 'u', press and hold down the front panel key for 5 seconds until the CPU Switch Smart SUN-MAC-PC displays 'C' to show that it has entered configure mode.

If you wish you may use the reset switch that is situated on the underside of the CPU Switch Smart SUN-MAC-PC (see figure 4) to perform a power-on reset without powering down the connected computers.

### **To enter configure mode whilst the CPU Switch Smart SUN-MAC-PC is running:**

Hold down the front panel key for 5 seconds until the front panel display shows 'C'.

In configure mode, options are entered by typing a letter followed by a number followed by (return). Use ESC to abort the entry of an option. The CPU Switch Smart SUN-MAC-PC will remain in configure mode until you type 'E' (return).

For example: to set hotkey option 2 type the following at the 'C' prompt

(at CPU Switch Smart SUN-MAC-PC 'C' prompt)



To exit configure mode type:





## 2.7 Summary of CPU Switch Smart SUN-MAC-PC configuration options

Full details of each of the configuration options and their uses are given in section 4.

**B1** - screen saver disabled (default)

**B2** - Blank screen after 1 minute of inactivity

**B3** - Blank screen after 2 minutes of inactivity

**B4** - Blank screen after 4 minutes of inactivity

**B5** - Blank screen after 8 minutes of inactivity

**B6** - Blank screen after 12 minutes of inactivity

**B7** - Blank screen after 16 minutes of inactivity

**B8** - Blank screen after 20 minutes of inactivity

**D1** - Sun default keyboard type = UK (default setting)

**D2** - Sun default keyboard type = UNIX / US

**S1** - Enable "hot media" keys (default)

**S2** - Disable "hot media" keys

**S3** - Enable shift-3 remap

**S4** - Disable shift-3 remap (default)

(Shift-3 remap inserts key sequence **[compose]**  )

**L1** - CPU Switch Smart SUN-MAC-PC locks on to active ports only during autoscanning (default)

**L2** - CPU Switch Smart SUN-MAC-PC locks on to every port during autoscanning

**L3** - CPU Switch Smart SUN-MAC-PC powers on in autoscan mode and locks on to active ports only

**L4** - CPU Switch Smart SUN-MAC-PC powers on in autoscan mode and locks on to all ports

**L7** - Cascade query code = AD (default)

**L8** - Cascade query code = EF

**T1** - 2 seconds autoscan delay time before switching to next port (default)

**T2** - 5 seconds autoscan delay time before switching to next port

**T3** - 7 seconds autoscan delay time before switching to next port

**T4** - 10 seconds autoscan delay time before switching to next port

**T5** - 15 seconds autoscan delay time before switching to next port

**T6** - 20 seconds autoscan delay time before switching to next port

**T7** - 30 seconds autoscan delay time before switching to next port

**T8** - 60 seconds autoscan delay time before switching to next port

**U1** - CPU Switch Smart SUN-MAC-PC channels are switchable using a 3 button mouse or IntelliMouse (default)

(CPU Switch Smart SUN-MAC-PC reports 2 button mouse mode to PCs)

**U2** - CPU Switch Smart SUN-MAC-PC channels are not switchable using 3 button mouse or IntelliMouse

(CPU Switch Smart SUN-MAC-PC reports 2 button mouse mode to PCs)

**U3** - CPU Switch Smart SUN-MAC-PC channels are not switchable using 3 mouse or IntelliMouse

(CPU Switch Smart SUN-MAC-PC reports 3 button mouse mode to PCs)

**U4** - CPU Switch Smart SUN-MAC-PC channels are switchable using 3 button mouse or IntelliMouse

(CPU Switch Smart SUN-MAC-PC reports IntelliMouse mode to PCs)

**U5** - CPU Switch Smart SUN-MAC-PC channels are not switchable using 3 button mouse or IntelliMouse

(CPU Switch Smart SUN-MAC-PC reports IntelliMouse mode to PCs)

**U7** – Cycle between all ports when switching with 'Hotkeys + Tab' or three button mouse (default)

**U8** – Cycle between active ports only when switching with 'Hotkeys + Tab' or three button mouse

**H1** - Hotkey combination is CTRL + ALT + command key (default)

**H2** - Hotkey combination is CTRL + SHIFT + command key

**H3** - Hotkey combination is ALT + SHIFT + command key

**H4** - Hotkey combination is RIGHT ALT + command key

**H5** - Hotkey combination is LEFT ALT + RIGHT ALT + command key

**H6** - Hotkey combination is LEFT CTRL + LEFT ALT + command key

**H7** - Hotkey combination is RIGHT CTRL + RIGHT ALT + command key

**H8** - No hotkey combination enabled

**F1** - Display firmware first digit (Note: F1 is **F** followed by **1** NOT **F1**)

**F2** - Display firmware second digit

**F3** - Display firmware third digit

**F5** - Restore PS/2 mouse function

**F6** - Restore IntelliMouse function

**F8** - RESET all configurations to default settings. (Display confirms with 'r').

**P** - Sets password - see section 4.6 for instructions.

**E** - Exits configure mode and returns the CPU Switch Smart SUN-MAC-PC to normal operation mode.

## **2.8 Resetting the CPU Switch Smart SUN-MAC-PC without disconnecting your devices**

The CPU Switch Smart SUN-MAC-PC draws its power from the connected computers and therefore may only be fully powered down when all the connected computers have been switched off or disconnected. However, the CPU Switch Smart SUN-MAC-PC may be reset without disconnecting or powering down your computers by using the reset switch on the underside of the unit. Performing a reset using this switch performs a complete hardware reset on the CPU Switch Smart SUN-MAC-PC and is equivalent to switching off the power. To perform a hardware reset, insert a small blunt object, such as the ball of a pen, into the small hole on the base of the CPU Switch Smart.

## **2.9 Other useful installation information**

**PC boot up sequence** - When your PCs are powered on they communicate with any attached keyboards and mice and setup parameters required by the particular operating system. It is necessary for the CPU Switch Smart SUN-MAC-PC to be attached and powered on during this sequence so that it can give the required responses and keep track of all the modes and settings requested by each of the connected PCs.

**Mouse characteristics** - do not unplug a PS/2 mouse connection from a PC whilst the PC is on. Due to the design of PS/2 mice communications the mouse function on the PC will be lost and you will have to re-boot the PC to regain normal operation. Unplugging the mouse from the CPU Switch Smart SUN-MAC-PC will also cause it to stop operating when it is plugged back in. RS232 mice can usually be unplugged and plugged back in provided that a mouse was connected when the operating system initially booted. The CPU Switch Smart SUN-MAC-PC is fitted with a PS/2 mouse recovery system which allows you to disconnect and re-connect the shared mouse without powering down the system (although this is generally not advisable) - see section 2.10 for details.

**Keyboard and mouse mode switching** - The CPU Switch Smart SUN-MAC-PC keeps a log of the keyboard and mouse mode and resolution settings requested by each of the connected computers. These settings are automatically restored to the shared keyboard and mouse when the CPU Switch Smart SUN-MAC-PC channel is switched thus ensuring maximum software compatibility. The keyboard num, caps and scroll lock states are an obvious example of this process.

## **2.10 Re-enabling a disconnected PS/2 mouse**

If you disconnect the shared PS/2 mouse from the CPU Switch Smart SUN-MAC-PC by accident during operation then the mouse operation will be lost when the mouse is plugged back in. To avoid having to reboot the entire system in this situation the CPU Switch Smart SUN-MAC-PC is fitted with an automatic mouse recovery system.

With the PS/2 mouse disconnected, change the channel using the keypad or keyboard hotkeys. The CPU Switch Smart SUN-MAC-PC detects that the mouse has been disconnected and triggers the automatic recovery system. Plug in the PS/2 mouse and the CPU Switch Smart SUN-MAC-PC will re-initialise it.

## **2.11 Hot plugging the CPU Switch Smart SUN-MAC-PC into running systems and re-enabling disconnected CPU PS/2 mouse connections**

It is advisable to switch off the systems that are going to be connected to the CPU Switch Smart SUN-MAC-PC before installation. However, if this is not possible then most systems can be hot plugged by using the CPU Switch Smart SUN-MAC-PC's mouse restoration functions. The keyboard connection will normally restore itself automatically.

On many PCs, mouse movement will be lost if the PS/2 mouse is unplugged and plugged back in whilst the PC is running. Mouse movement can then only be restored by rebooting the PC. This is because the mouse drivers only setup and enable the mouse when the PC is initially booted.

If you have switched off your CPU Switch Smart SUN-MAC-PC or you are attempting to 'hot plug' it into a system that is already running, you may be able to

restore lost mouse movement using the CPU Switch Smart SUN-MAC-PC's mouse restoration functions.

**Mouse restoration functions should be used with care as unpredictable results may occur if the wrong mouse type is selected. If in doubt restore the mouse by powering down the PC normally.**

Standard PS/2 mouse data uses a different data format to IntelliMouse data and so two reset functions are provided on the CPU Switch Smart SUN-MAC-PC. The type of data format expected by the PC depends upon the driver and the type of mouse that was connected when the driver was booted. The following table may be used as a guide.

Note that the mouse reset functions predict the likely mouse resolution settings but may not restore the speed or sensitivity of the mouse exactly as they were when the PC originally booted.

Type of mouse / system Connected at bootup	Driver type	Likely expected data format	Suggested restoration
PS/2	PS/2 only	PS/2	F5
PS/2	IntelliMouse	PS/2	F5
IntelliMouse / CPU Switch Smart	PS/2 only	PS/2	F5
IntelliMouse / CPU Switch Smart	IntelliMouse	IntelliMouse	F6

To restore lost mouse movement on a CPU connected to the CPU Switch Smart SUN-MAC-PC:

- 1) Select the CPU that has lost its mouse movement
- 2) Press the select key on the front of the CPU Switch Smart SUN-MAC-PC for 5 seconds until 'C' is displayed. You are now in configure mode.
- 3) To restore a PS/2 mouse connection press



Or, to restore an IntelliMouse connection press



- 4) Exit from configure mode by typing



5) Test the mouse movement by moving the mouse a short distance.

**F5** - Restore PS/2 mouse function

**F6** - Restore IntelliMouse function

## **2.12 Upgrading the CPU Switch Smart's flash memory**

The CPU Switch Smart SUN-MAC-PC uses flash memory technology which enables the firmware code to be upgraded by the user. Upgrades are performed by connecting a PC's serial port to the CPU Switch Smart's options port and running an upgrade program on the PC. This upgrade program downloads the new firmware to the CPU Switch Smart and checks that the data has been programmed correctly.

To perform a firmware upgrade on your CPU Switch Smart SUN-MAC-PC you will need a suitable serial upgrade cable and an IBM PC compatible computer with an RS232 serial port and an operating system that supports DOS. Upgrade cables may be purchased from LINDY Electronics or may be made using the wiring specification given in Appendix A4. You will also need to download the latest version of the CPU Switch Smart SUN-MAC-PC firmware which is available free of charge at **[www.LINDY.com](http://www.LINDY.com)**.

To perform a flash upgrade on the CPU Switch Smart SUN-MAC-PC:

### **Step 1 - Connect your computer to the CPU Switch Smart**

Connect your computer's serial port to the CPU Switch Smart SUN-MAC-PC's options port (labelled OPTIONS/FLASH).

### **Step 2 - Reset the CPU Switch Smart SUN-MAC-PC whilst holding down the front panel key**

The CPU Switch Smart SUN-MAC-PC may be reset by powering it off and then on again. Remember that the CPU Switch Smart SUN-MAC-PC draws its power from any of the connected computers so you will need to power down or disconnect all the computers to power down the CPU Switch Smart. Alternatively you may reset the CPU Switch Smart by inserting a small blunt object, such as the nib of a ball point pen, into the small hole located on the underside of the CPU Switch Smart (see figure 4). Hold down the front panel key BEFORE the CPU Switch Smart is reset and keep it held down until the CPU Switch Smart has powered on and displays 'u'.

### Step 3 - Ensure that the CPU Switch Smart SUN-MAC-PC is powered on and displays 'u'

Ensure that the CPU Switch Smart is powered on. It is normally possible to upgrade the CPU Switch Smart when it is powered from a single computer. The upgrade program monitors the CPU Switch Smart's voltage and will not allow an upgrade to be performed if the voltage is insufficient.

The display should now show:

#### DISPLAY SHOWS

Lower case U

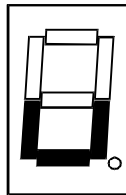

#### MEANING

CPU Switch Smart is ready to be upgraded

### Step 4 - Run the upgrade program

The latest version of the CPU Switch Smart SUN-MAC-PC firmware is available from the LINDY Technology website at [www.LINDY.com](http://www.LINDY.com). The upgrade files will be supplied to you as a group and consist of several files as explained below. These files should be downloaded to the same directory on your computer.

- 1) A universal upgrade program

#### AVMP.EXE

- 2) Binary code files for each of the processors within the CPU Switch (up to 3)

e.g.

**MP129M.HEX**

**MP129S.HEX**

**MP129U.S19**

These files use the following naming scheme. The first two characters are the product type (e.g. MP = CPU Switch Smart SUN-MAC-PC). The next three characters represent the firmware release version (e.g. 129 equals version 1.29). The last character is designation that tells the upgrade program where to load the file within the MP.

3) A data file that tells the upgrade program (AVMP.EXE) which binary code files to download to the CPU Switch Smart SUN-MAC-PC and where to put each file. Theoretically this DAT file can be modified so that only certain processors are upgraded but do not do this unless specifically instructed by LINDY technical support.

e.g. **MP129SPU.DAT**

Like the code files, the first two digits represent the product type (e.g. MP is CPU Switch Smart SUN-MAC-PC). The next three digits represent the version number (e.g. 129 equals firmware version 1.29). The last three digits are the model number (e.g. SPU is the CPU Switch Smart SUN-MAC-PC supporting Sun, PC and USB protocols).

To upgrade the CPU Switch Smart SUN-MAC-PC, check that the DAT file designation matches the model that you have. In other words, if you have an CPU Switch Smart SUN-MAC-PC and you want to upgrade to version 1.30 then the DAT file that you need would be named MP130SPU.DAT. Also check that all the required files are loaded into the same directory on your computer. From that directory run the upgrade file using the following command line.

**AVMP {Dat\_file\_name}.DAT**

Where **{Dat\_file\_name}** is the name of the required DAT file

For example, if the name of the required DAT file is MP129SPU.DAT then use the following command line:

**AVMP MP129SPU.DAT**

For your convenience the upgrade files will include a batch file that contains the command shown above. To run the upgrade using the batch file, type the name of the batch file e.g.

**MP129SPU**

Follow the instructions given on the screen to perform the upgrade. When the upgrade is complete the program will confirm that the upgrade has been successful and then quit.



During the upgrade the display will show an upper case U and the dot will flash to show that the upgrade is in progress.

#### DISPLAY SHOWS

Upper case U

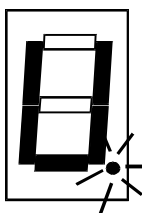

#### MEANING

CPU Switch is  
in flash upgrade  
mode

Flashing dot indicates  
that data is being  
received from the PC

### Step 5 - Complete the upgrade process

When the upgrade program reports that the upgrade process is complete, reset the CPU Switch Smart SUN-MAC-PC to start normal operation. This may be done by powering off the CPU Switch Smart SUN-MAC-PC or by using the reset switch located on the underside of the CPU Switch Smart.

#### Some useful issues to bear in mind when performing flash upgrades

The upgrade program rewrites the CPU Switch Smart's firmware code. If the upgrade process is interrupted then the CPU Switch Smart will have invalid code and will not be able to operate. It is therefore good practice to ensure that the upgrade process is always fully completed. A partial or failed upgrade may be rectified by performing another upgrade. If the upgrade process is interrupted accidentally then you should immediately repeat the upgrade process. Running faulty or partially upgraded code may have unpredictable results and may damage your CPU Switch Smart SUN-MAC-PC or computing equipment. For obvious reasons, the code that the CPU Switch Smart SUN-MAC-PC uses to perform upgrades is not itself upgradeable - a common problem on some flash upgradeable products that could effectively be destroyed by a partial upgrade!

**WARNING - Running faulty or partially upgraded code may have unpredictable results and may damage your CPU Switch Smart or computing equipment.**

## **IMPORTANT NOTE**

**The upgrade programs are DOS based to enable compatibility with the widest range of operating systems. They run efficiently on DOS, Windows 3.X, Workgroups, 95, 98, ME and Windows NT. The upgrades will take approximately 10 minutes but vary slightly according to the SmartView model and the speed of the PC. Upgrades run from PCs using Windows 2000 will take very substantially longer due to the way that this operating system handles the DOS programs. The upgrade will be reliable but may take around 3 hours to complete!**

## 3. Using the CPU Switch Smart SUN-MAC-PC

---

This section explains the general operation of the CPU Switch Smart SUN-MAC-PC. We recommend that you read this section before starting to use the product.

### 3.1 Power on status

At power on the CPU Switch Smart SUN-MAC-PC selects computer 1 and displays '1'. If a password has been set then 'P' will be displayed and the CPU Switch Smart SUN-MAC-PC will remain locked until a valid password is entered.

#### DISPLAY SHOWS

Display doesn't show '1' or 'P'

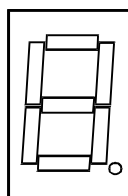

#### MEANING

No power is available or insufficient power is available from the connected PCs

Channel '1' or 'P' prompt

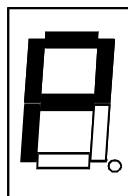
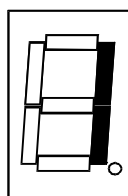

CPU Switch has powered up normally and there is sufficient power available from the connected PCs

### 3.2 Front panel key and remote controller

The front panel key is used to select which channel is currently controlled by the shared keyboard, mouse and monitor ports. Pressing the key during normal operation will cause the next channel to be selected.

The key can also be used to access the CPU Switch Smart SUN-MAC-PC's configuration mode (see section 2.6). To do this press the key and hold it down for 5 seconds until 'C' appears on the CPU Switch Smart SUN-MAC-PC's front panel display.

An optional remote controller is also available which replicates the front panel key

and display, but can be located remotely from the CPU Switch Smart SUN-MAC-PC. This is particularly useful in applications where the CPU Switch Smart SUN-MAC-PC is located away from the desktop. The remote controller can be conveniently attached to your keyboard with a couple of Velcro strips to give instant channel information and key control.

### 3.3 Status display

The status display usually shows the currently selected port. If autoscan mode is selected, the segments will illuminate in sequence in a clockwise direction interspersed with a display of the currently selected channel. If CPU Switch Smart SUN-MAC-PC has been locked, 'P' will be displayed until a valid password has been typed to unlock the unit. Data flow from the mouse or keyboard causes the dot to flash.

#### DISPLAY SHOWS

#### MEANING

Channel number displayed and dot in lower right hand corner flashes (0 indicates CPU Switch is disabled)

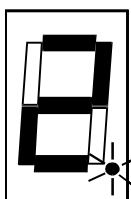

Activity on keyboard or mouse

Illuminated segment shifts clockwise with port number shown after each scan round

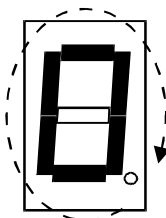

Auto-scan mode - scanning from channel to channel at rate as programmed by user

'P' prompt

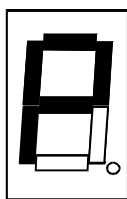

Locked mode waiting for password to be entered

Display flashes port number

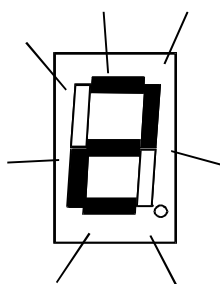

CPU Switch is in screen save mode - keyboard, mouse or keypad activity will re-enable the video

### 3.4 Keyboard hotkey control

CPU Switch Smart SUN-MAC-PC can be conveniently controlled by selecting channel, autoscan mode or security locking from the keyboard. All of the hotkey control commands are invoked by holding down the two hotkeys and then pressing a command key. By default, the two hotkeys are 'CTRL' and 'ALT', although other combinations can be selected by reconfiguring the hotkeys (see section 4.4). Once the hotkey command has been activated you will need to release the hotkeys and the command key before a new hotkey command is accepted by the CPU Switch Smart SUN-MAC-PC. HOTKEYs + TAB is an exception and this allows you to 'tab through' the ports by holding down the hotkeys and repeatedly pressing TAB.

The hotkey command are summarised below (note that the numbers on the numeric keypad do not form part of a valid hotkey) :

**'HOTKEYs' and '1'** - selects channel 1

**'HOTKEYs' and '2'** - selects channel 2

**'HOTKEYs' and '3'** - selects channel 3

**'HOTKEYs' and '4'** - selects channel 4

**'HOTKEYs' and 'TAB'** - selects the next channel

**'HOTKEYs' and 'A'** - selects autoscan mode where each channel is displayed for the selected time (see section 4.2). To cancel autoscan mode simply select any fixed channel either by hotkey or using the CPU Switch Smart SUN-MAC-PC button.

**'HOTKEYs' and '0'** – switches off the video signal and displays 0. This will cause some monitors to go into standby mode or switch off. The video signal can be re-enabled by selecting a channel.











**'HOTKEYs' and 'L'** - disables the CPU Switch Smart SUN-MAC-PC's keyboard and mouse and displays 0. The video signal is switched off. If a password has not been set then the CPU Switch Smart SUN-MAC-PC can be re-enabled by selecting a channel. If a password has been set then the CPU Switch Smart SUN-MAC-PC displays 'P' to indicate that a valid password must be entered to unlock the switch. Simply type the same key combination as was set during configuration (see section 4.7) followed by the (return) key. Note - if anyone has typed at the keyboard whilst in secure mode, it will be necessary to type (return) first to clear the invalid password, then type the valid password followed by (return) again.

Examples of common hotkey sequences (assuming CTRL + ALT hotkey option):

**To select channel 2:**

press    release   



**To 'tab through' channels:**

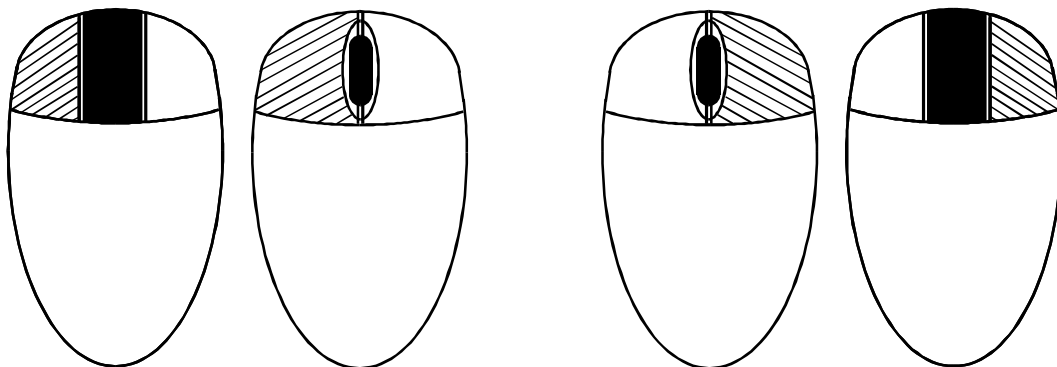

press    release  press   
 release  press  release   

### 3.5 Mouse control

Computers may conveniently be selected using a three button mouse. In order to switch to the next computer simply hold down the central mouse button (the wheel mouse button on an IntelliMouse) and click on the left hand mouse button to select the next computer or the right hand mouse button to select the previous computer. If the CPU Switch Smart has been set to scan active ports then the next or previous active channel will be selected. If it has been set to scan all ports then the next or previous numerical channel in sequence will be selected (see section 4.5 for more details). Mouse switching may be enabled or disabled by setting options during configuration (see section 4.3). When mouse switching is disabled the third button or wheel button state is 'passed through' the CPU Switch Smart and seen by the application software.



Hold down centre button (  )  
 Press and release left hand button  
 (  ) to select next computer

Hold down centre button (  )  
 Press and release right hand button  
 (  ) to select previous computer

## 4. CPU Switch Smart SUN-MAC-PC configuration options

---

All the options described in this section are entered in CPU Switch Smart SUN-MAC-PC configure mode - see section 2.6 for instructions on entering configure mode.

### 4.1 Screen saver time delay

CPU Switch Smart SUN-MAC-PC contains a programmable screen saver which will blank the display after the set time delay with no keyboard or mouse activity. Simply typing at the keyboard or moving the mouse will re-enable the display. The display will flash whilst the CPU Switch Smart SUN-MAC-PC is in screen save mode.

**B1** - screen saver disabled (default)

B2 - Blank screen after 1 minute of inactivity

B3 - Blank screen after 2 minutes of inactivity

B4 - Blank screen after 4 minutes of inactivity

B5 - Blank screen after 8 minutes of inactivity

B6 - Blank screen after 12 minutes of inactivity

B7 - Blank screen after 16 minutes of inactivity

B8 - Blank screen after 20 minutes of inactivity

### 4.2 Autoscan 'lock on' mode and delay time

CPU Switch Smart SUN-MAC-PC can be set to select each channel in turn for a period of time set by the autoscan delay time. Autoscan mode is entered by typing the hotkey keys together with 'A'. By default, only those channels which have a powered up computer connected to them will be scanned. Sometimes it may be desirable to scan all channels, even if the attached computer is switched off (this will simply show a blank screen when it is selected). All the CPU Switch Smart SUN-MAC-PC's ports will be scanned if option L2 is selected. Some applications may also require the CPU Switch Smart SUN-MAC-PC to power on in autoscan mode. This feature can be selected using the L3 or L4 options.

- L1 - CPU Switch Smart SUN-MAC-PC only locks on to active ports during autoscanning (default)
- L2 - CPU Switch Smart SUN-MAC-PC locks on to every port in turn during autoscanning
- L3 - CPU Switch Smart SUN-MAC-PC powers on in autoscan mode and locks on to active ports only
- L4 - CPU Switch Smart SUN-MAC-PC powers on in autoscan mode and locks on to all ports

- T1 - 2 seconds autoscan delay time before switching to next port (default)
- T2 - 5 seconds autoscan delay time before switching to next port
- T3 - 7 seconds autoscan delay time before switching to next port
- T4 - 10 seconds autoscan delay time before switching to next port
- T5 - 15 seconds autoscan delay time before switching to next port
- T6 - 20 seconds autoscan delay time before switching to next port
- T7 - 30 seconds autoscan delay time before switching to next port
- T8 - 60 seconds autoscan delay time before switching to next port

Note: Autoscan mode is ended simply by selecting a fixed channel using the keypad, the keyboard hotkeys or the mouse.

**WARNING - Many modern monitors are fitted with automatic power save relays and will switch off after a few seconds if connected to an inactive PC. If you are using such a monitor you must not use the L2 feature. Constant switching on and off of your monitor's relay will eventually damage your monitor.**

### 4.3 Mouse mode and mouse switching of channels

A three button PS/2 mouse or an IntelliMouse can be used to switch channels on the CPU Switch Smart SUN-MAC-PC. To switch to the next channel, the user simply holds down the central button or wheel button and presses the left or right hand button to change the channel (see section 3.5). If the user does not wish to take advantage of this feature, it can be disabled by selecting U2, U3 or U5. If the third button is being used to switch the CPU Switch Smart SUN-MAC-PC then it is not available for use with PC software although the function of an IntelliMouse wheel is not affected. Consequently in modes U1, U2 and U4 the CPU Switch Smart SUN-MAC-PC reports to the PCs that a 2 button mouse is connected. If you wish to use the full function of a 3 button mouse or IntelliMouse for your PC software then you



should select options U3 or U5.

The CPU Switch Smart SUN-MAC-PC supports 'Internet Mice' that are compatible with the Microsoft IntelliMouse. These are fitted with a wheel or other scroll control and sometimes have additional buttons.

Examples are:

- Microsoft IntelliMouse
- Logitech Pilot Mouse +
- Logitech MouseMan+
- Genius NetMouse
- Genius NetMouse Pro

Standard PS/2 and IntelliMouse compatible mice can be connected to the control port. You may configure your CPUs using Microsoft PS/2 or IntelliMouse drivers in any combination as required. The IntelliMouse features are supported on both PS/2 and RS232 CPU connections. When using PS/2 CPU connections, the CPU Switch Smart SUN-MAC-PC will automatically configure itself to the type of mouse requested by the driver. If you are using RS232 CPU connections then you will need to select mouse options U4 or U5 to enable the IntelliMouse features.

- U1** - CPU Switch Smart SUN-MAC-PC channels are switchable using a 3 button mouse or IntelliMouse  
(CPU Switch Smart SUN-MAC-PC reports 2 button mouse mode to PCs)
- U2** - CPU Switch Smart SUN-MAC-PC channels are not switchable using 3 button mouse or IntelliMouse  
(CPU Switch Smart SUN-MAC-PC reports 2 button mouse mode to PCs)
- U3** - CPU Switch Smart SUN-MAC-PC channels are not switchable using 3 button mouse or IntelliMouse  
(CPU Switch Smart SUN-MAC-PC reports 3 button mouse mode to PCs)
- U4** - CPU Switch Smart SUN-MAC-PC channels are switchable using 3 button mouse or IntelliMouse  
(CPU Switch Smart SUN-MAC-PC reports IntelliMouse mode to PCs)
- U5** - CPU Switch Smart SUN-MAC-PC channels are not switchable using 3 button mouse or IntelliMouse  
(CPU Switch Smart SUN-MAC-PC reports IntelliMouse mode to PCs)

## 4.4 Keyboard hotkey combination

The keyboard hotkey combination is used to change a channel, set autoscan mode or secure the product (so that the password needs to be typed before it can be used again). The following keyboard hotkey combinations can be selected. These hotkey combinations are used together with the command keys to trigger the required CPU Switch Smart SUN-MAC-PC function. The left and right alt key combination is particularly suitable for extended keyboards where additional keys can be programmed to act as a combination of other keys. Such keyboards are supplied with many Gateway 2000 computers. Programming spare keys to trigger the hotkey combination allows channels to be selected via a single key stroke.

H1 - 'CTRL' and 'ALT' keys together (left or right hand keys operate) (default)

H2 - 'CTRL' and 'SHIFT' keys together (left or right hand keys operate)

H3 - 'ALT' and 'SHIFT' keys together (left or right hand keys operate)

H4 - 'RIGHT ALT' key

H5 - 'LEFT ALT' and 'RIGHT ALT' keys together

H6 - 'LEFT CTRL' and 'LEFT ALT' keys together

H7 - 'RIGHT CTRL' and 'RIGHT ALT' keys together

H8 - No hotkey enabled



## 4.5 Cycling between all channels or just the active channels





The CPU Switch Smart SUN-MAC-PC can be set to cycle between all channels or just the active channels when using 'Hotkeys + Tab' or a three button mouse to switch the channel. This avoids wasting time viewing channels that are not active. Option are:

U7 – Cycle between all ports when switching with 'Hotkeys + Tab' or three button mouse (default)

U8 – Cycle between active ports only when switching with 'Hotkeys + Tab' or three button mouse

## 4.6 Firmware functions (version query, mouse restore and reset)

For technical support purposes, it may be necessary to find the firmware release version for the control software in your CPU Switch Smart SUN-MAC-PC. For example, if the release version is v1.29 the response shown to    will be a

brief display of the digit '1', then **F 2**  will be a brief display of the digit '2', then **F 3**  will be a brief display of the digit '9'. You can reset all of the configured options back to the factory default states by typing **F 8** . Use options **F 5**  and **F 6**  to restore mouse function on disconnected PS/2 CPU mouse connections.

F1 - Display firmware first digit (Note: F1 is **F** followed by **1** NOT **F1**)

F2 - Display firmware second digit

F3 - Display firmware third digit

F5 - Restore PS/2 mouse function to the currently selected CPU's mouse port

F6 - Restore IntelliMouse function to the currently selected CPU's mouse port

F8 - Reset all configurations to factory default settings. An 'r' will show briefly on the display to confirm that the reset has been completed.

## 4.7 Setting a security password

There are many situations where unrestricted access to corporate file servers or sensitive information needs to be controlled. In such circumstances, the CPU Switch Smart SUN-MAC-PC can be locked away in a room or secure cabinet and controlled remotely. In this mode typing the keyboard hotkeys together with 'L' will blank the screen, disconnect the keyboard and mouse from all of the computers and display 'P' on the CPU Switch Smart SUN-MAC-PC display. Control can only be regained by typing the correct password on the keyboard.

To set the password in configure mode, first type 'P' then (return). The display on CPU Switch Smart SUN-MAC-PC will change to show '=' and you can then type your password. The password is not case sensitive and can be any combination of key strokes, including the function keys, but excluding the (ctrl), (alt), (shift) and (return) keys and the keys that only appear on a Sun type keyboard (i.e. Help, Stop, Again, props, Undo, Front, Copy, Open, Paste, Find, Cut and the media control keys). When you have typed in your password type (return) to register it in the stored memory. Do not worry if you type the password incorrectly, you can always re-enter configure mode and set the password again. If you have lost the password and the CPU Switch Smart SUN-MAC-PC is locked, the unit may be unlocked by powering down the CPU Switch Smart SUN-MAC-PC, entering configure mode at power on (see section 2.6), and performing a complete reset using the F8 function.

NOTE - The password consists of a combination of key strokes rather like the code

to a safe. The key strokes are not case sensitive and can include all the keys on the keyboard (except ctrl, alt, shift and enter). Consequently the following 'password' would be valid:



#### 4.8 Cascade query code

The CPU Switch Smart SUN-MAC-PCs use a special 'query code' to detect whether or not they are connected to another CPU Switch Smart SUN-MAC-PC. By default your CPU Switch Smart SUN-MAC-PC uses query code AD. CPU Switch Junior (another range of keyboard / mouse / video switches from LINDY Electronics) units with firmware versions less than 1.09 used query code EF. This was found to conflict with a small number of other (rare) devices that used the same query code so an alternative query code was provided to ensure compatibility. Either query code may be used but you should make sure that all cascaded CPU Switch Smart SUN-MAC-PC and CPU Switch Junior units are set to use the same query code. If any of the cascaded CPU Switch Junior have firmware versions less than 1.09 then the cascade query code for all the CPU Switch Smart SUN-MAC-PCs and CPU Switch Junior should be set to EF.

L7 – Cascade query code = AD (default)

L8 – Cascade query code = EF

#### 4.9 Resolving slow mouse problems

Due to certain technical reasons some systems running particular combinations of operating system and mouse drivers are sensitive to small timing changes relating to mouse communications. The introduction of a switch like the CPU Switch Smart inevitably causes some timing changes and in rare cases interactions have been observed that causes the mouse to run very slowly. Certain HP Vectra computers running later versions of Windows NT with Logitech mouse drivers and Logitech mice have been observed to exhibit such interactions with older switches. One solution to this problem is to change the mouse driver.

The CPU Switch Smart SUN-MAC-PC is a high performance device that is carefully engineered to minimise such interactions and should not exhibit this characteristic. Nevertheless such interactions are unpredictable and so the CPU Switch Smart is

fitted with a feature that ensures that the mouse can never operate at a very slow rate regardless of such interactions. This feature is activated using the following options:

**L5** – Allow the mouse to run at any speed (default)

**L6** – Don't allow the mouse to run at very slow speeds

#### **4.10 Sun keyboard type**

The CPU Switch Smart SUN-MAC-PC interrogates any attached Sun keyboard to find out its country code / type setting. This is then communicated back to any attached Sun computer. If a Sun keyboard is not attached then the MP will report a default type setting as defined below.

**D1** - Sun default keyboard type = UK (default setting)

**D2** - Sun default keyboard type = UNIX / US

#### **4.11 Using the Sun keyboard's "hot media" keys to select computers**

The four "hot media" keys on the top right hand side of a Sun keyboard can be re-allocated to change the CPU Switch Smart SUN-MAC-PC's channel. When the functions of these keys have been reallocated they will not be available for computer control.

**S1** - Enable "hot media" keys (default)

**S2** - Disable "hot media" keys

#### **4.12 Customising the Sun keyboard operation to force the generation of a £**

In some circumstances it is useful to reallocate the Shift + 3 key combination to force the generation of a pound sign. This is done using the following options.

**S3** - Enable shift-3 remap

**S4** - Disable shift-3 remap (default)

#### **4.13 Exit configure mode**

When you have finished configuring any special options, simply type 'E' followed by (return) to exit configure mode and return to normal operation mode. The attached computers can now be switched on.

# Appendix A. Cable and connector specifications

---

## IMPORTANT NOTE

The maximum cable lengths supported vary widely between devices and cables. It may be possible to use cables that are longer than those specified below with certain computers and peripherals but this cannot be guaranteed. If you experience problems try using shorter cables.

### A1. Keyboard, monitor and mouse to CPU Switch Smart SUN-MAC-PC

All of the shared devices plug directly into the relevant ports at the rear of the CPU Switch Smart SUN-MAC-PC. If you use a PC AT style keyboard you will need an AT (5 pin DIN female) to PS/2 (6 pin mini-DIN male) converter.

#### **Cable specification (self-powered operation):**

Keyboard, monitor and mouse cables should be no longer than 2 metres.

#### **Cable specification (with optional power adapter):**

Keyboard, monitor and mouse extension cables can be used to increase the distance from CPU Switch Smart SUN-MAC-PC up to 10m. Most keyboards and mice will also operate at distances of 20 metres.

## A2. CPU Switch Smart SUN-MAC-PC to computers 1 to 4

### Cables for connection to PCs:

When used without the optional power adapter, cables to PCs may be up to 5 metres long. With the optional power adapter the cables may be extended up to 30 metres using standard extension cables. Video extension cables should be good quality with a coaxial construction and should support the DDC (Display Data Channel) signals (pins 12 and 15 on the 15-way video connector). Please contact your supplier if you have any questions.

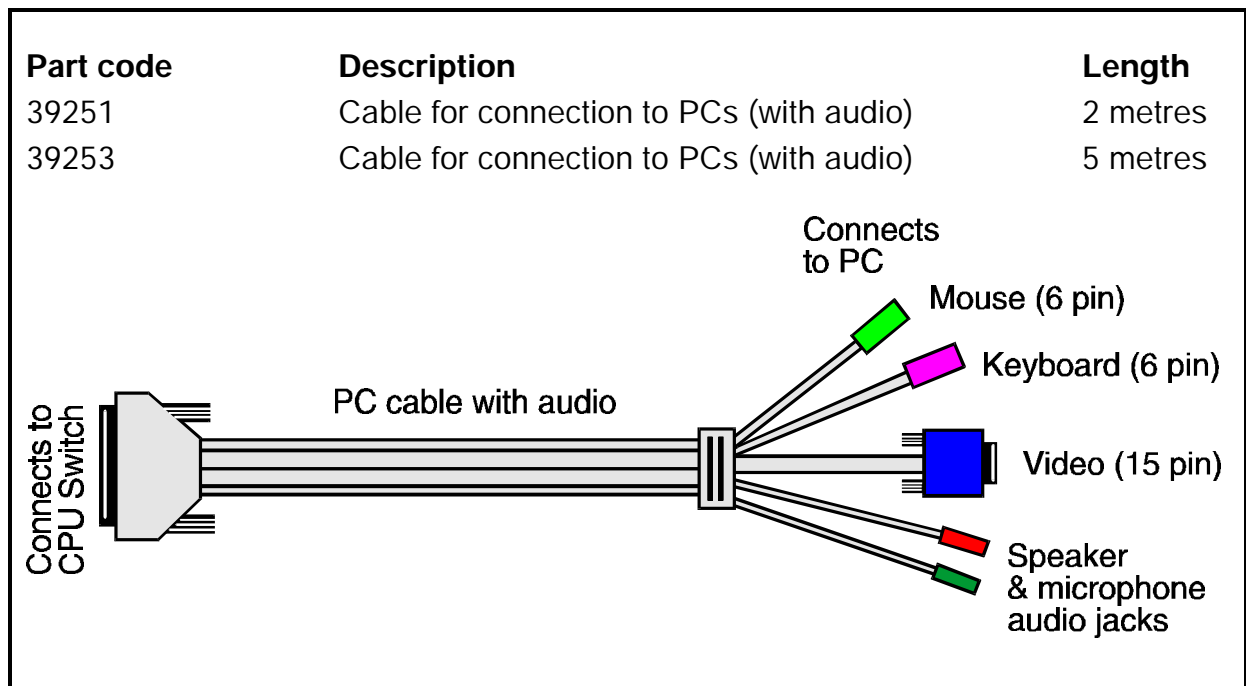



**Cables for connection to Sun computers with 8-pin keyboard/mouse connectors:**

When used without the optional power adapter, cables to Sun computers with 8 pin mini-DIN keyboard/mouse connectors may be up to 5 metres long. With the optional power adapter the cables may be extended up to 30 metres using standard extension cables.

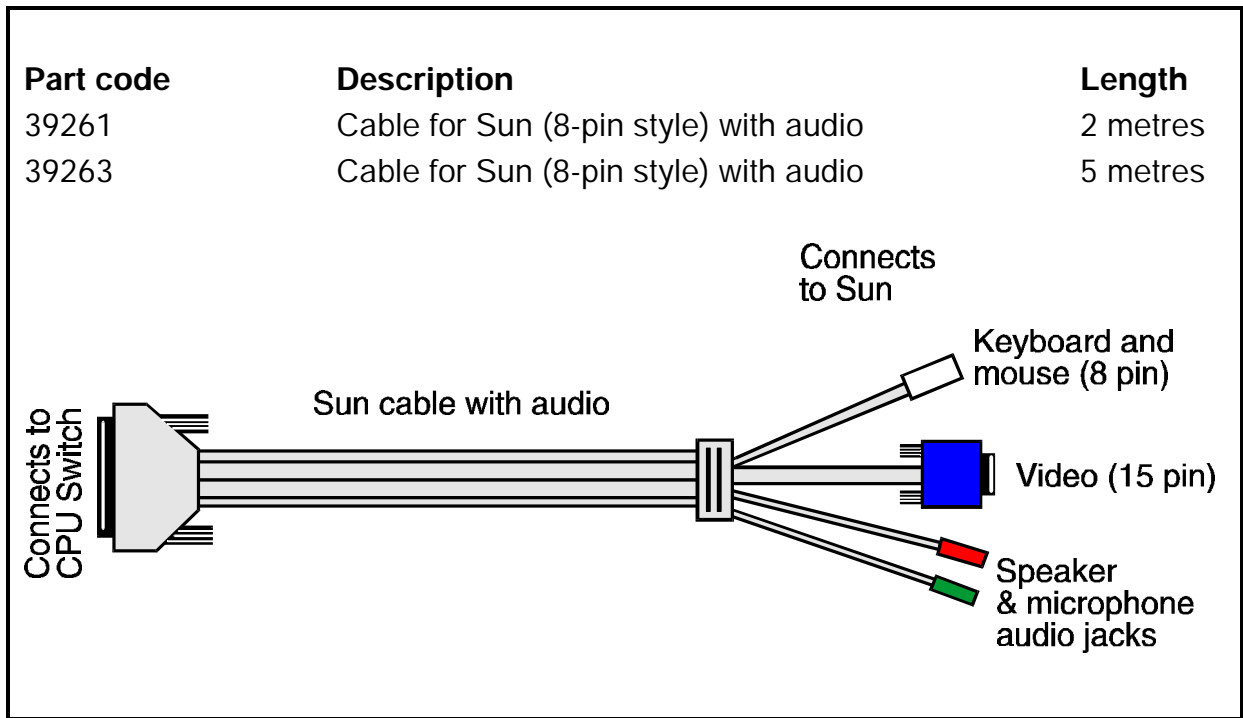

**Cables for connection to computers with USB keyboard/mouse connections:**

<b>Part code</b>	<b>Description</b>	<b>Length</b>
39256	Cable for USB-enabled computers with audio	2 metres
39258	Cable for USB-enabled computers with audio	5 metres

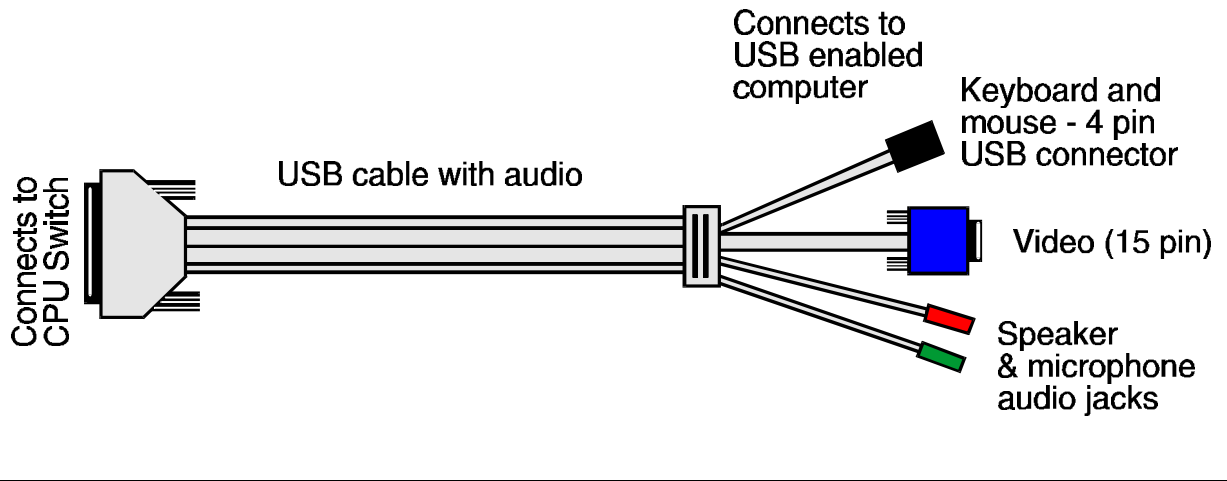

**Adapters:**

**70058 mouse adapter** - This is required if you wish to connect a computer that has a 9-pin serial mouse connection:

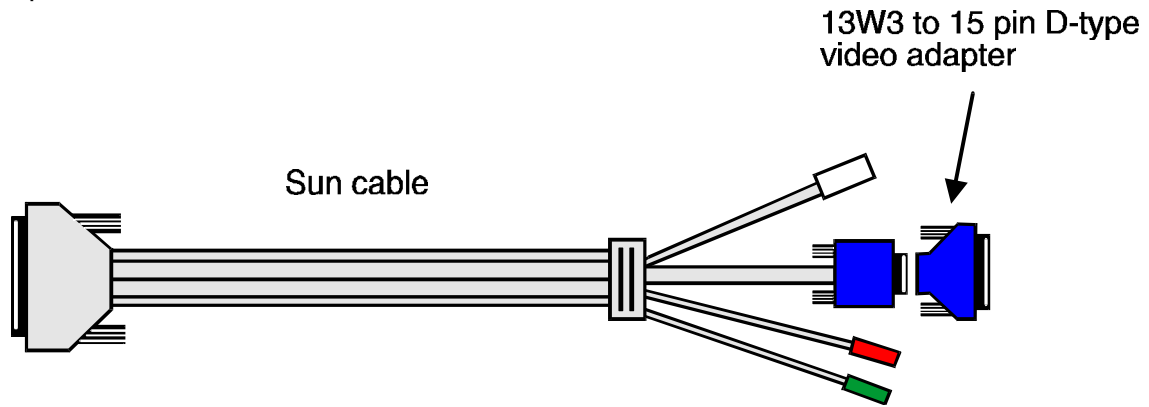

**6 pin mini-DIN female**  
takes cable from CPU Switch

**9 pin D female**  
plugs into PC serial port

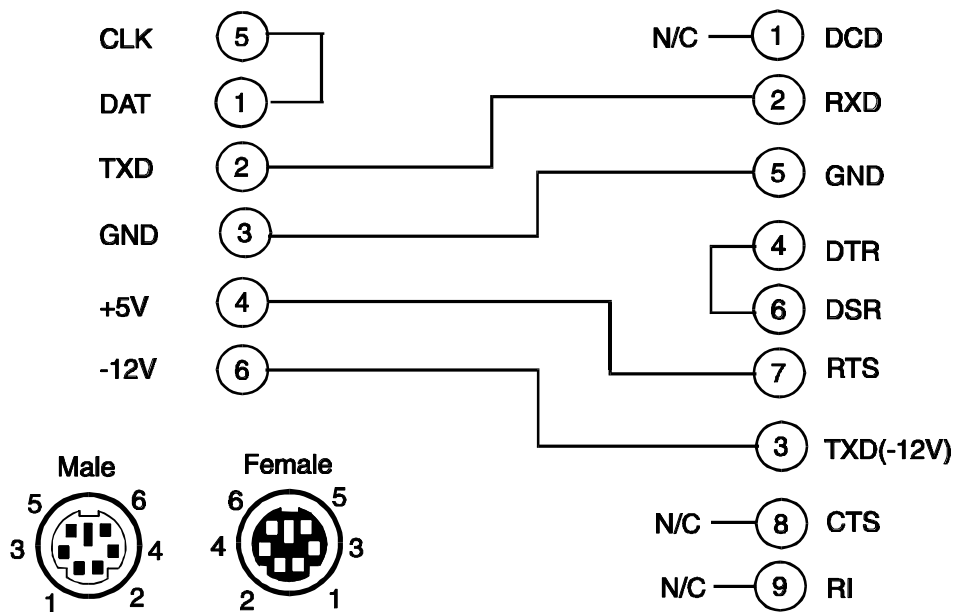

Cables should be no longer than 30 metres.

**NOTE - There are several common wiring specifications for 6-pin mini-DIN to 9-pin serial adapters. If you have an adapter that has been supplied with a mouse it may have a completely different internal wiring to that shown above and may not be compatible with the CPU Switch Smart SUN-MAC-PC**

**70130 keyboard adapter** - If your PC has a 5-pin DIN AT style keyboard connector you will need a PS/2 to AT keyboard adapter 6-pin mini-DIN female to 5-pin DIN male.

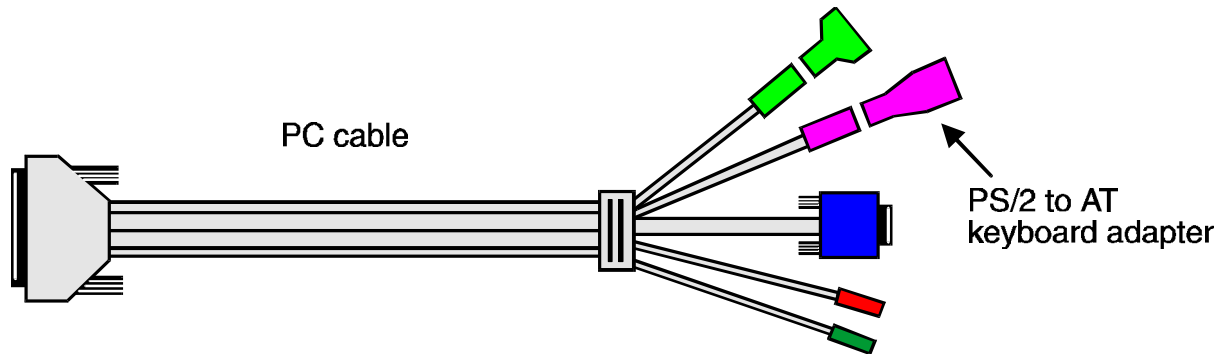

**70127 video adapter** - If your Sun computer has a 13W3 video connector then you will need to fit a 15-way D-type to 13W3 video adapter onto the end of the Sun cable.

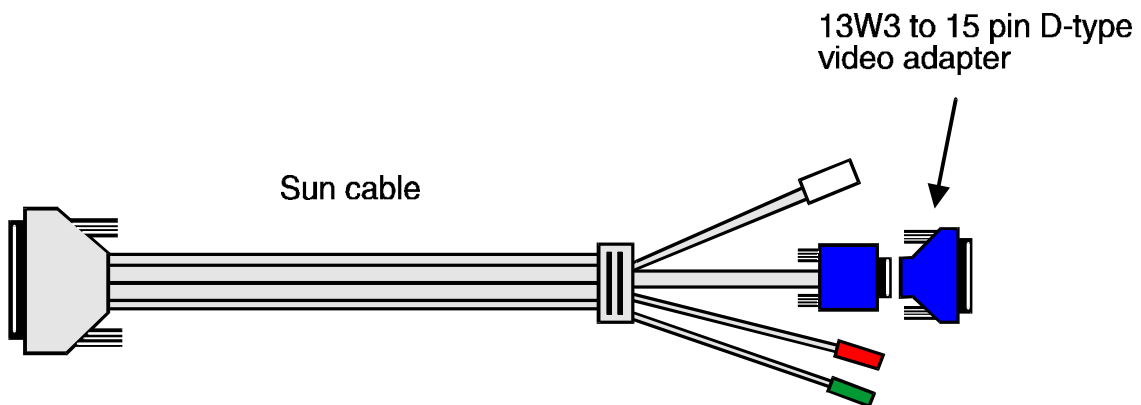

## A.3 Flash upgrade cable connection

The cable connections shown below are to connect either COM1 or COM2 of a PC to the CPU Switch Smart SUN-MAC-PC to allow flash upgrades.

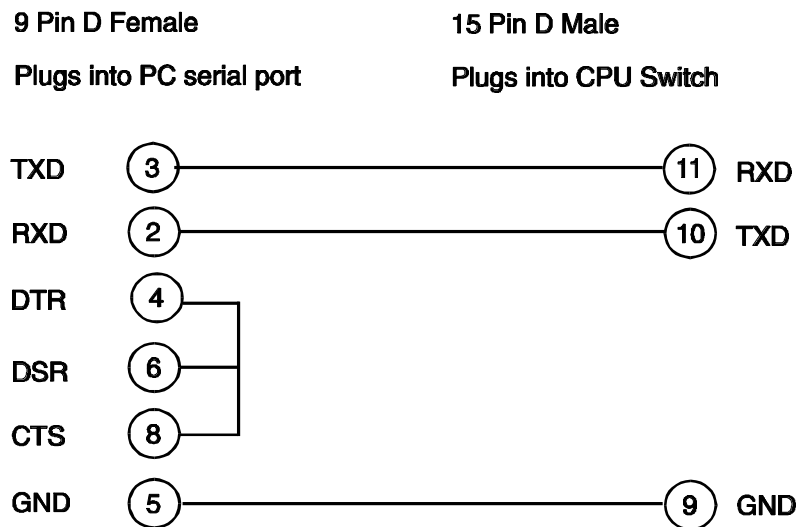

## Appendix B. Problem Solving

---

### Problem:

Mouse causes channel to change.

### Action:

Some cheaper mice are not fully compatible with the CPU Switch Smart SUN-MAC-PC and can lose data causing the channel to be changed (if mouse switching of channels is enabled). If you experience this problem then change the mouse and use a Microsoft, Sun, Logitech, IBM, Compaq or Hewlett-Packard type. If your computer is a PC then ensure that you are using a Microsoft compatible mouse driver. Some other manufacturers' drivers may switch the mouse to use a proprietary mouse data format not supported by the CPU Switch Smart SUN-MAC-PC. If you have unplugged and re-connected a mouse to the CPU Switch Smart SUN-MAC-PC then ensure that you reset it using the mouse reset function (see section 2.10).

### Problem:

Mouse jumps around the screen after disconnecting the mouse cable or powering down the CPU Switch Smart SUN-MAC-PC.

### Action:

If you have disconnected and re-connected a CPU mouse cable or you have powered down the CPU Switch Smart SUN-MAC-PC then the mouse data format may be out of synchronisation with that required by the PC (PS/2 or Intellimouse). Try the 'restore Intellimouse' function (F6) to resolve the problem or re-power the CPU.

### Problem:

On PCs, mouse moves very slowly but otherwise functions correctly.

### Action:

Change the mouse driver to a Microsoft type or take the action recommended in section 4.9.

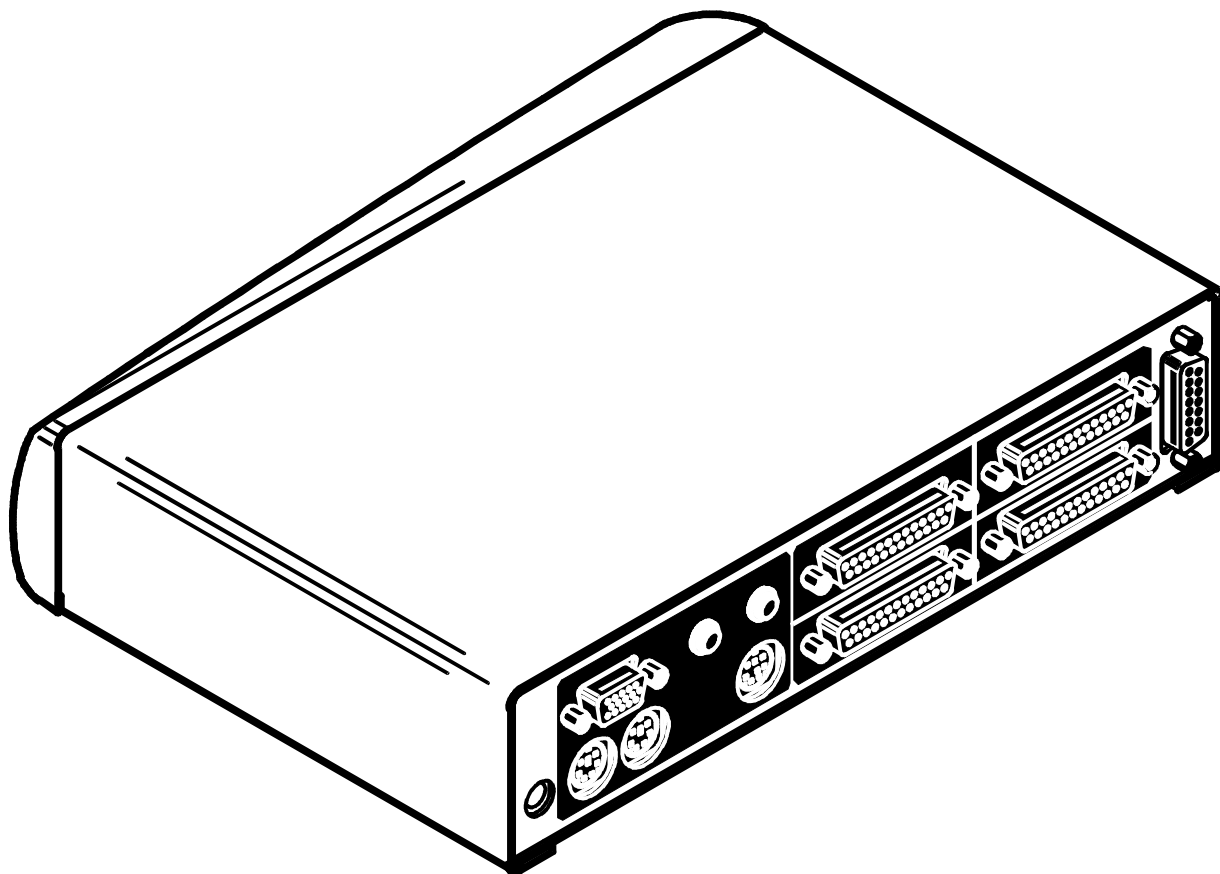

**[www.LINDY.com](http://www.LINDY.com)**

---

**CPU Switch Smart SUN-MAC-PC**

## Free Manuals Download Website

<http://myh66.com>

<http://usermanuals.us>

<http://www.somanuals.com>

<http://www.4manuals.cc>

<http://www.manual-lib.com>

<http://www.404manual.com>

<http://www.luxmanual.com>

<http://aubethermostatmanual.com>

Golf course search by state

<http://golfingnear.com>

Email search by domain

<http://emailbydomain.com>

Auto manuals search

<http://auto.somanuals.com>

TV manuals search

<http://tv.somanuals.com>