LINDY CPU Switch Dual/Quad Pro

Manual

English



LINDY Art. Nr. 32361 LINDY CPU Switch Dual Pro 4 Port
LINDY Art. Nr. 32362 LINDY CPU Switch Dual Pro 8 Port
LINDY Art. Nr. 32364 LINDY CPU Switch Quad Pro 16 Port

GB USA	An electronic version of this manual may be downloaded from www.LINDY.com
D	A German version of this manual may be downloaded from www.LINDY.com
F	A French version of this manual may be downloaded from www.LINDY.com

About this manual

LINDY Dual/Quad PRO- Installation and Use

Second edition (October 2001)

(c) 2001 LINDY Electronics Ltd

Part No. 32361	LINDY CPU Switch Dual Pro 4 Port
Part No. 32362	LINDY CPU Switch Dual Pro 8 Port
Part No. 32364	LINDY CPU Switch Quad Pro 16 Port
Part No. 32391	LINDY Junior Extender Receiver
Part No. 32392	LINDY Pro Extender Receiver

All rights reserved. Whilst every precaution has been taken in the preparation of this manual, LINDY Electronics Ltd assumes no responsibility for errors or omissions. Neither is any liability assumed for damages resulting from the use of the information contained herein. We reserve the right to change the specifications, functions and circuitry of the product without notice. All trademarks acknowledged.

Safety information

- For use in dry, oil free indoor environments only.
- Do not attempt to service the LINDY Dual/Quad PRO yourself.
- Follow all warnings and instructions marked on the LINDY Dual/Quad PRO, its power adapter and its accessories.
- Warning - live parts contained within power adapter.
- No user serviceable parts within power adapter - do not dismantle.
- Plug the power adapter into a socket outlet close to the LINDY Dual/Quad PRO.
- Replace the power adapter with a manufacturer approved type only.
- Do not use power adapter if power adapter case becomes damaged, cracked or broken or if you suspect that it is not operating properly.
- If you use a power extension cord with the LINDY Dual/Quad PRO, make sure the total ampere rating of the devices plugged into the extension cord does not exceed the cord's ampere rating. Also, make sure that the total ampere rating of all the devices plugged into the wall outlet does not exceed the wall outlet's ampere rating.

Warranty

LINDY Electronics Ltd warrants that this product shall be free from defects in workmanship and materials for a period of 1 year from the date of original purchase. If the product should fail to operate correctly in normal use during the warranty period, LINDY will replace or repair it free of charge. No liability can be accepted for damage due to misuse or circumstances outside LINDY's control. Also LINDY will not be responsible for any loss, damage or injury arising directly or indirectly from the use of this product. LINDY's total liability under the terms of this warranty shall in all circumstances be limited to the replacement value of this product. If any difficulty is experienced in the installation or use of this product that you are unable to resolve, please contact your supplier.

Radio Frequency Energy

Shielded cables must be used with this equipment to maintain compliance with radio frequency energy emission regulations and ensure a suitably high level of immunity to electromagnetic disturbances.

European EMC directive 89/336/EEC

This equipment has been tested and found to comply with the limits for a class A computing device in accordance with the specifications in the European standard EN55022. These limits are designed to provide reasonable protection against harmful interference. This equipment generates, uses and can radiate radio frequency energy and if not installed and used in accordance with the instructions may cause harmful interference to radio or television reception. However, there is no guarantee that harmful interference will not occur in a particular installation. If this equipment does cause interference to radio or television reception, which can be determined by turning the equipment on and off, the user is encouraged to correct the interference with one or more of the following measures: (a) Reorient or relocate the receiving antenna. (b) Increase the separation between the equipment and the receiver. (c) Connect the equipment to an outlet on a circuit different from that to which the receiver is connected. (d) Consult the supplier or an experienced radio / TV technician for help.

FCC Compliance Statement (United States)

This equipment generates, uses and can radiate radio frequency energy and if not installed and used properly, that is, in strict accordance with the manufacturer's instructions, may cause

interference to radio communication. It has been tested and found to comply with the limits for a class A computing device in accordance with the specifications in Subpart J of part 15 of FCC rules, which are designed to provide reasonable protection against such interference when the equipment is operated in a commercial environment. Operation of this equipment in a residential area may cause interference, in which case the user at his own expense will be required to take whatever measures may be necessary to correct the interference. Changes or modifications not expressly approved by the manufacturer could void the user's authority to operate the equipment.

Canadian Department of Communications RFI statement

This equipment does not exceed the class A limits for radio noise emissions from digital apparatus set out in the radio interference regulations of the Canadian Department of Communications.

Le présent appareil numérique n'émet pas de bruits radioélectriques dépassant les limites applicables aux appareils numériques de la classe A prescrites dans le règlement sur le brouillage radioélectriques publié par le ministère des Communications du Canada.

Contents

1. Introduction	5
1.1 Key features and benefits	6
1.2 LINDY Dual/Quad PRO package contents	8
1.3 LINDY Junior Extender receiver package contents	8
1.4 LINDY Pro Extender receiver package contents	8
1.5 Product information	9
2. Installation	13
2.1 What you will need	13
2.2 Mounting the LINDY Dual/Quad PRO	15
2.3 Connecting your devices	15
2.4 Configuring your PCs	16
2.5 Structuring your LINDY Dual/Quad PRO installation	17
2.6 Maximising the video quality	22
2.7 Other useful installation information	23
2.8 Re-enabling a disconnected PS/2 mouse	23
2.9 Hot plugging the LINDY Dual/Quad PRO into running systems and re-enabling disconnected PS/2 CPU mouse connections	24
3. Configuring the LINDY Dual/Quad PRO	26
3.1 Configuration summary	26
3.2 Enabling password security	27
3.3 Setting an ADMIN password	28
3.4 Creating and editing user accounts	28
3.5 Creating and editing computer names	29
3.6 Setting the SETUP OPTIONS and GLOBAL PREFERENCES	33

4. Using the LINDY Dual/Quad PRO..... 39

4.1 Rear panel special function switches	39
4.2 Power supply connections and indicators	39
4.3 USER display and key switch	39
4.4 COMPUTER display and key switch.....	40
4.5 Activity indicators	41
4.6 Selecting a computer using the front panel controls.....	41
4.7 Logging on to the LINDY Dual/Quad PRO	42
4.8 Keyboard hotkeys	43
4.9 Selecting computers using the mouse	45
4.10 Selecting computers using the on-screen menu.....	46
4.11 The reminder banner	50
4.12 Setting the USER PREFERENCES.....	51
4.13 Using the FUNCTIONS menu.....	52
4.14 Querying the routing status	53
4.15 Using the dual access ports (1 and 3)	54
4.16 Cascading LINDY Dual/Quad PRO's	54
4.17 Resetting user port keyboards and mice	55
4.18 Using the LINDY extender	56
4.19 What to do if you forget your ADMIN password	56
4.20 Saving and restoring the menu configuration to and from an Excel compatible spreadsheet.....	57

5. Upgrading the LINDY Dual/Quad PRO's firmware 60

Appendices

A - Cable and connector specifications.....	65
B - Problem solving.....	68

1. Introduction

Thank you for purchasing the LINDY Dual/Quad PRO. Your LINDY Dual/Quad PRO is a very high performance Keyboard, Video monitor and Mouse (KVM) sharing device which supports a wide range of PC hardware and software platforms. The LINDY Dual/Quad PRO supports multiple users and enables each user to independently access the connected computers.

An On-Screen-Display (OSD) menu system is provided for easy computer selection and control. This enables users to select computers by name or description without having to remember the port that the computer is physically connected to. The OSD menu system also provides a security structure that enables the system administrator to allocate access rights to each user on a login basis.

LINDY Dual/Quad PRO products are fitted with one (2) or two (4) dual access user ports. These dual access ports have both traditional KVM connectors for local keyboard, monitor and mouse connections and an RJ45 link for connection to a remote LINDY extender unit. This gives the user the ability to connect to the LINDY Dual/Quad PRO from up to 200 metres away using common twisted pair network cable whilst still having the ability to access the LINDY Dual/Quad PRO using a local KVM console.

We trust that you will be delighted with the function of your new LINDY Dual/Quad PRO. We are always interested to hear any suggestions that you may have for additional features or functionality (email to: postmaster@lindy.co.uk). Product enhancement upgrades are provided free of charge during the warranty period and may be obtained by request from www.lindy.co.uk. Some of the main features and benefits that are offered by your LINDY Dual/Quad PRO are listed in section 1.1

LINDY explains:

What does KVM stand for?

Throughout this manual the abbreviation KVM is used to refer to the combination of a Keyboard, Video monitor and Mouse that is used to access a computer. A KVM console usually consists of a keyboard, monitor and mouse although sometimes only a keyboard and monitor may be used. Devices such as the LINDY Dual/Quad PRO are generally known as KVM sharers or KVM switches.

1.1 Key features and benefits

- Enables many computers to be independently controlled by multiple users.
- On-screen menu allows computers to be selected by name or description.
- Configurable security enables administrator to assign access rights to users.
- Dual-access port(s) with built-in 200 metre LINDY extender connections enable the LINDY Dual/Quad PRO to be controlled from local and remote KVM consoles.
- Two independent users are supported on 2 models via one local KVM port and one dual-access local / remote KVM port.
- Four independent users are supported on 4 models via two local KVM ports and two dual-access local / remote KVM ports.
- Advanced On-Screen Display (OSD) for easy control and configuration.
- Channel switching by On-Screen Display, front panel key, keyboard hotkey, or 3 button mouse.
- Supports high bandwidth monitors at resolutions up to 1920 x 1440.
- Fully flash upgradable via the serial port (upgrade cable included).
- Supports a very wide range of software including Windows 3.X, WFWG, 95, 98, 2000, NT, ME, XP, DOS, Unix, Linux, NetWare, OS/2, BSD etc.
- Video channels support Display Data Channel (DDC/DDC1/DDC2) signalling.
- Supports desktop and laptop PCs, RS6000s, DEC Alphas, and Silicon Graphics computers.
- Dual power supply capability and front panel "healthy voltage" indicators provide power redundancy, high reliability and peace of mind.
- Support for up to 16 user access profiles and 512 named computers.
- The colours and position of the OSD menu may be changed by each user.
- Optional small-sized reminder banner permanently confirms the selected computer.
- Supports three computer control modes - Exclusive, Shared and Video Only.

- OSD routing status window shows the computers that are currently being controlled by the KVM consoles.
- Compact 1U (2) and 2U (4) cases may be neatly fitted under a monitor or fixed into a 19 inch rack using the supplied rack-mount kit.
- SmartBoot ensures reliable simultaneous bootup of all computers.
- User and computer name information may be uploaded to a PC and saved in an Excel compatible file. This file may be edited in Excel and downloaded back to the CPU Switch.
- Mixed AT/PS2 keyboards and PS2/RS232 mice supported as standard.
- Can be cascaded to a depth of four levels to provide a video switching network.
- Automatically restores keyboard and mouse states when channel changed.
- Supports keyboard modes 1,2 and 3 and mouse prompt and stream modes for maximum compatibility.
- Includes screen saver, auto-scan, variable hotkey and name search options.
- Supports moving or blank screen savers and auto-logout on screen save option.
- Wheel mouse may be used to launch and operate the OSD menus.
- User may select English, French or German OSD menus.
- Positive confirmation of selected ports on local and cascaded LINDY Dual/Quad PRO's achieved by full acknowledgement signalling across all cascaded units.
- Supports Microsoft IntelliMouse, IntelliMouse Explorer and other common wheel mice.
- Supports keyboards with extra Internet and audio function keys because the keyboard data is kept in its native format.
- Mouse restoration functions to enable 'hot plugging' of certain systems.
- Front panel controls may be locked for secure operation.
- Individual power-down reset of user ports enables hot-swapping of KVM consoles.
- Standard colour-coded cable connections make installation easy and inexpensive.

1.2 LINDY Dual/Quad PRO package contents

- LINDY Dual/Quad PRO.
- Power supply suitable for your country.
- 6 x stick on self-adhesive rubber feet.
- 2 x mounting brackets for fixing the unit into a 19 inch rack.
- 4 x screws for fixing mounting brackets to LINDY Dual/Quad PRO (6 screws supplied with Quad PRO models)
- This installation guide.
- A serial cable for flash upgrades and upload / download functions.

1.3 LINDY JUNIOR EXTENDER receiver package contents (part code 32391)

- LINDY Junior Extender receiver.
- Power supply suitable for your country.
- Installation and Use guide

1.4 LINDY PRO EXTENDER receiver package contents (part code 32392)

- LINDY Pro Extender receiver.
- Power supply suitable for your country.
- Installation and Use guide.

1.5 Product information

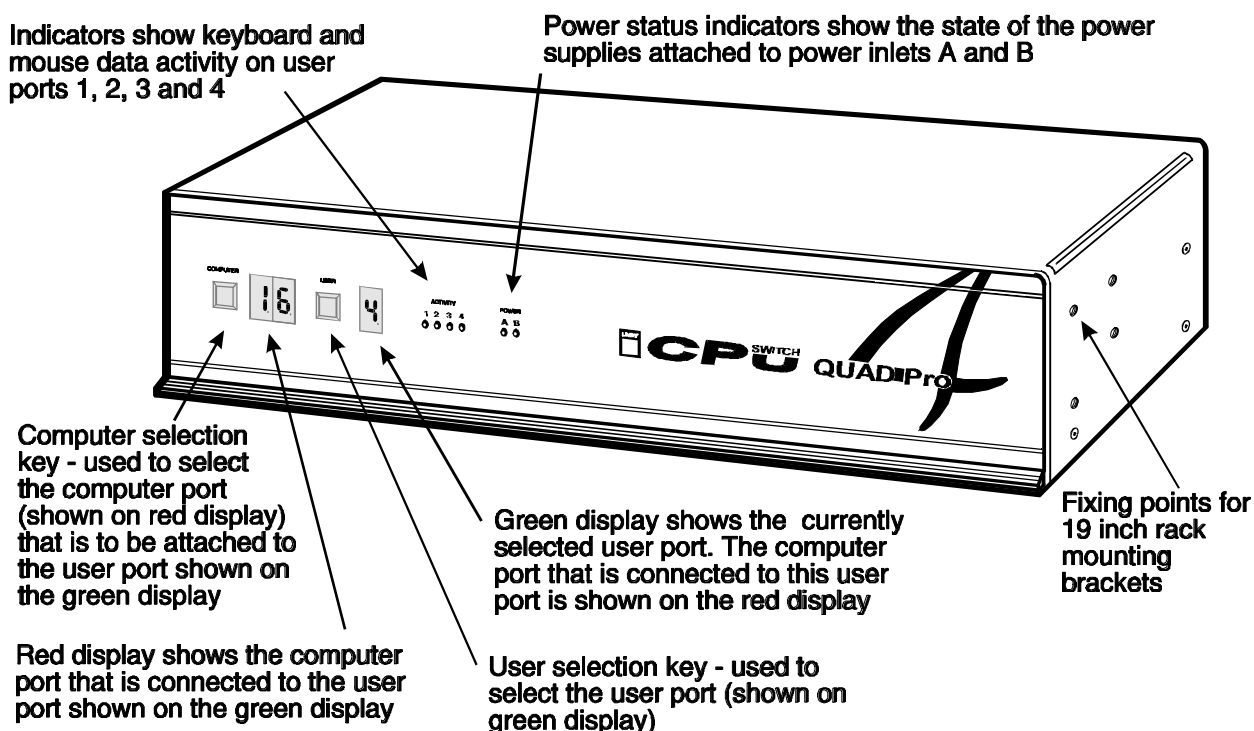
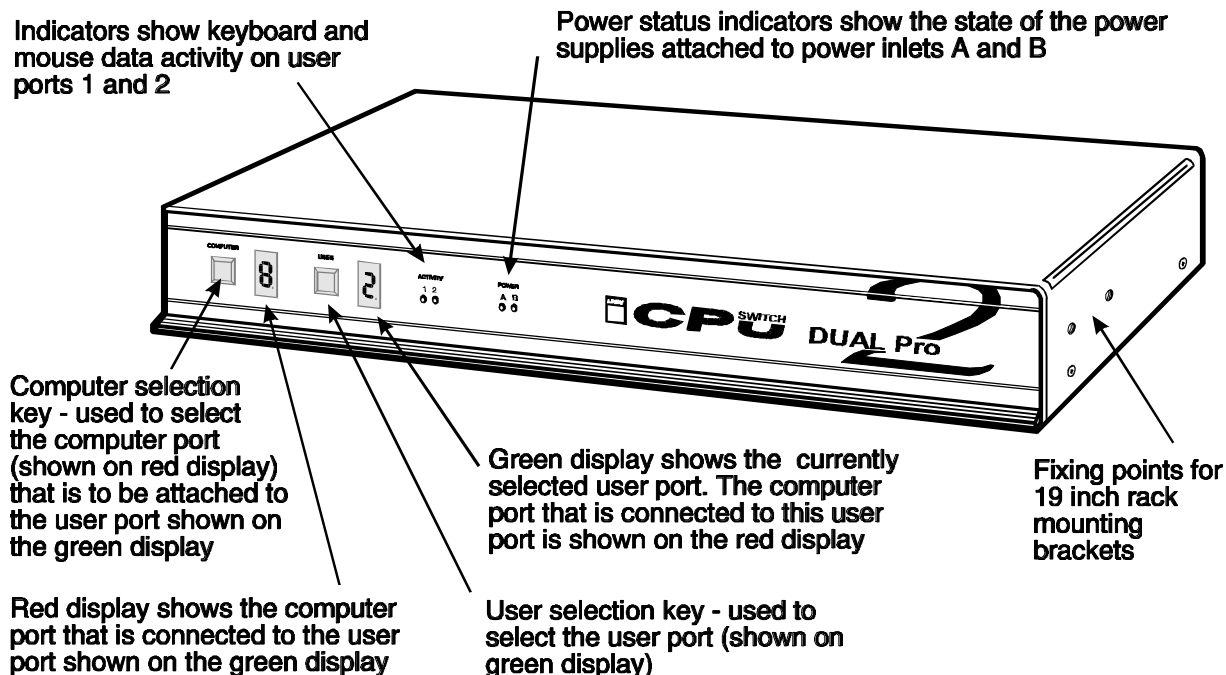

Fig. 1 - LINDY Dual/Quad PRO models viewed from the front

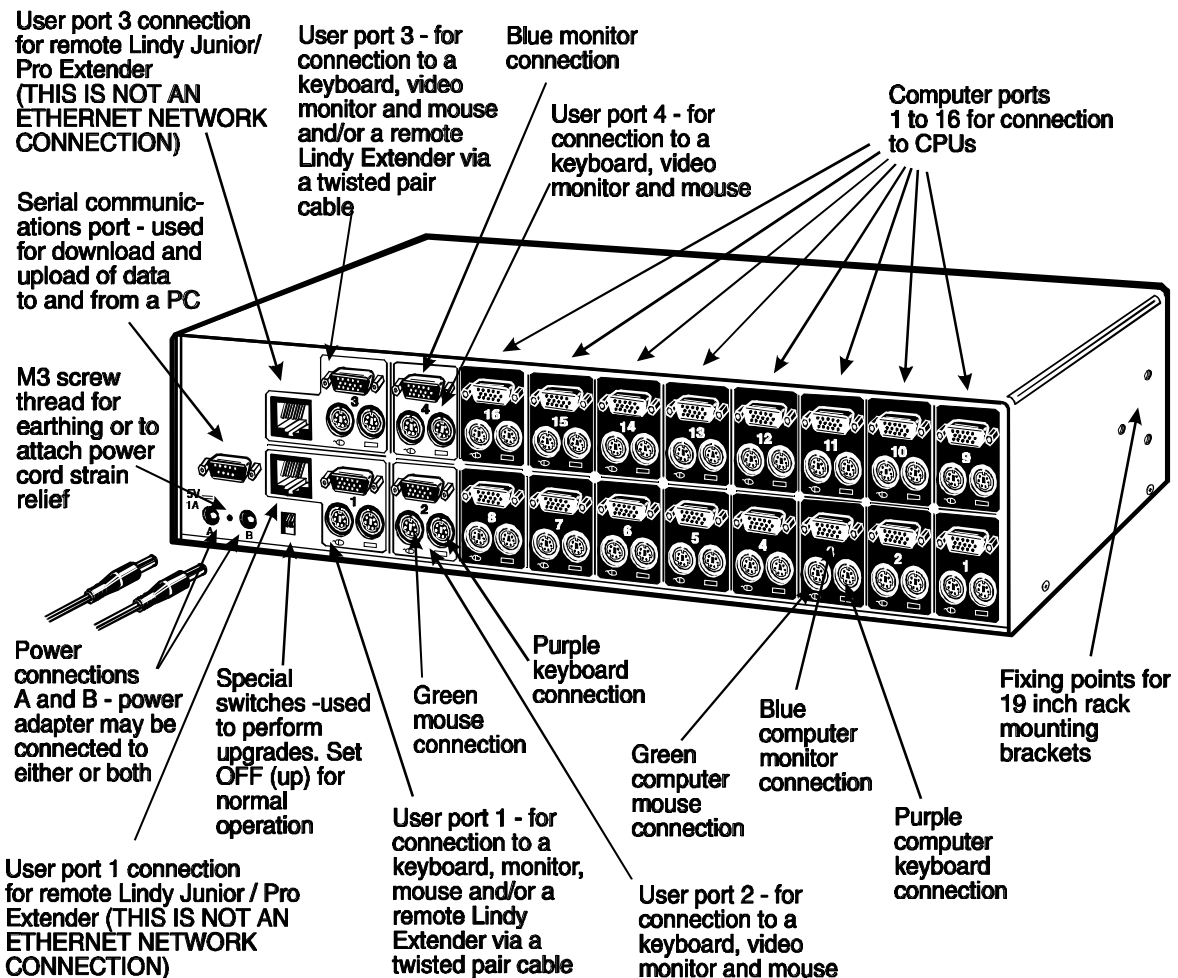
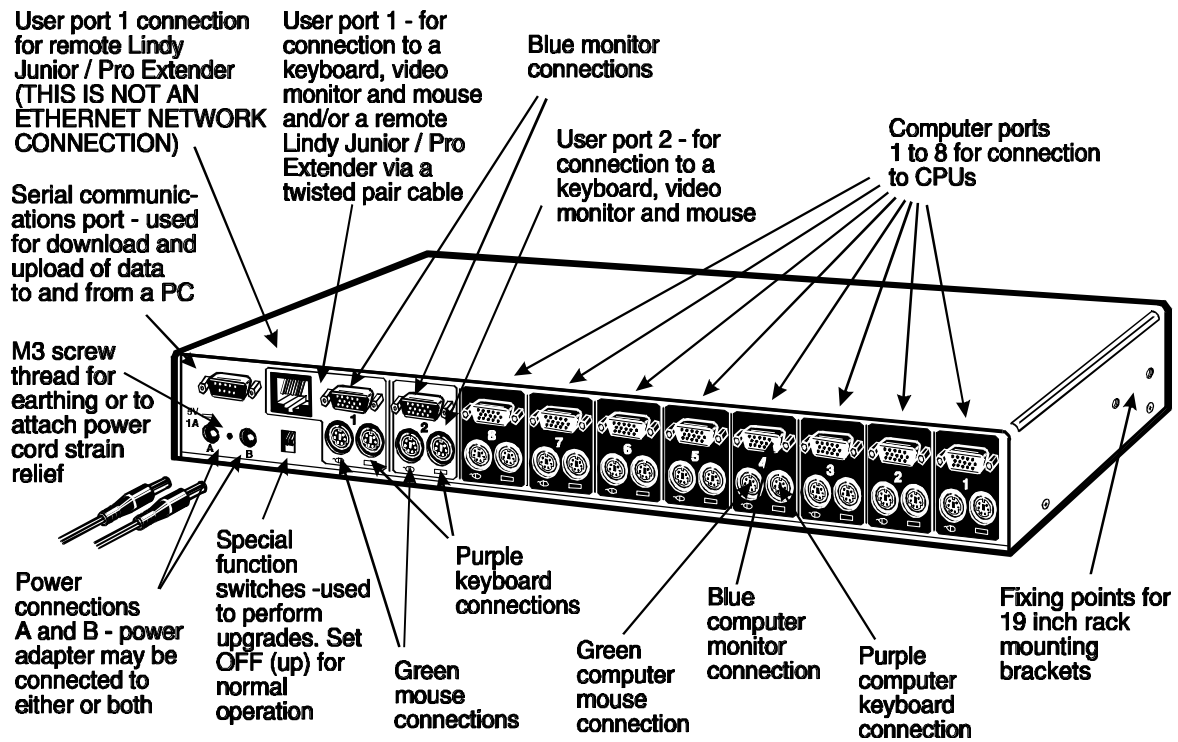

Fig. 2 - LINDY Dual/Quad PRO 8 and 16 port models viewed from the rear (4 and 12 port models are similar but with less computer ports)

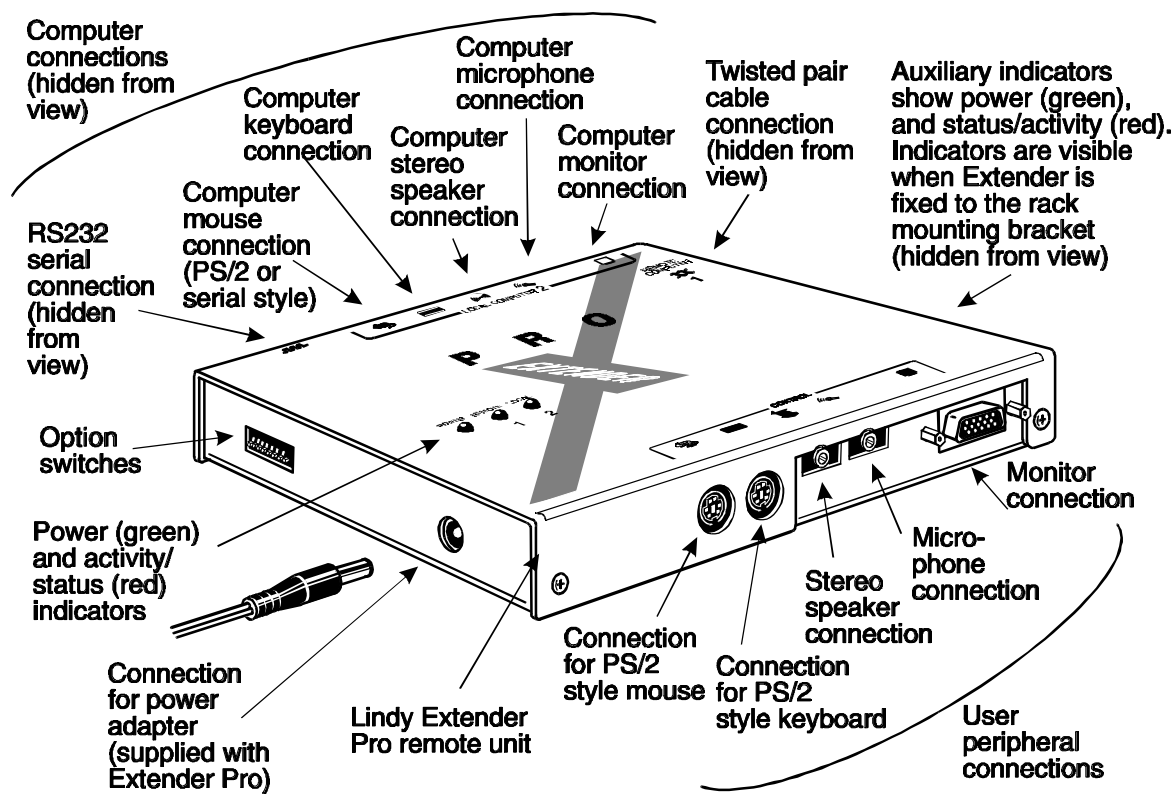
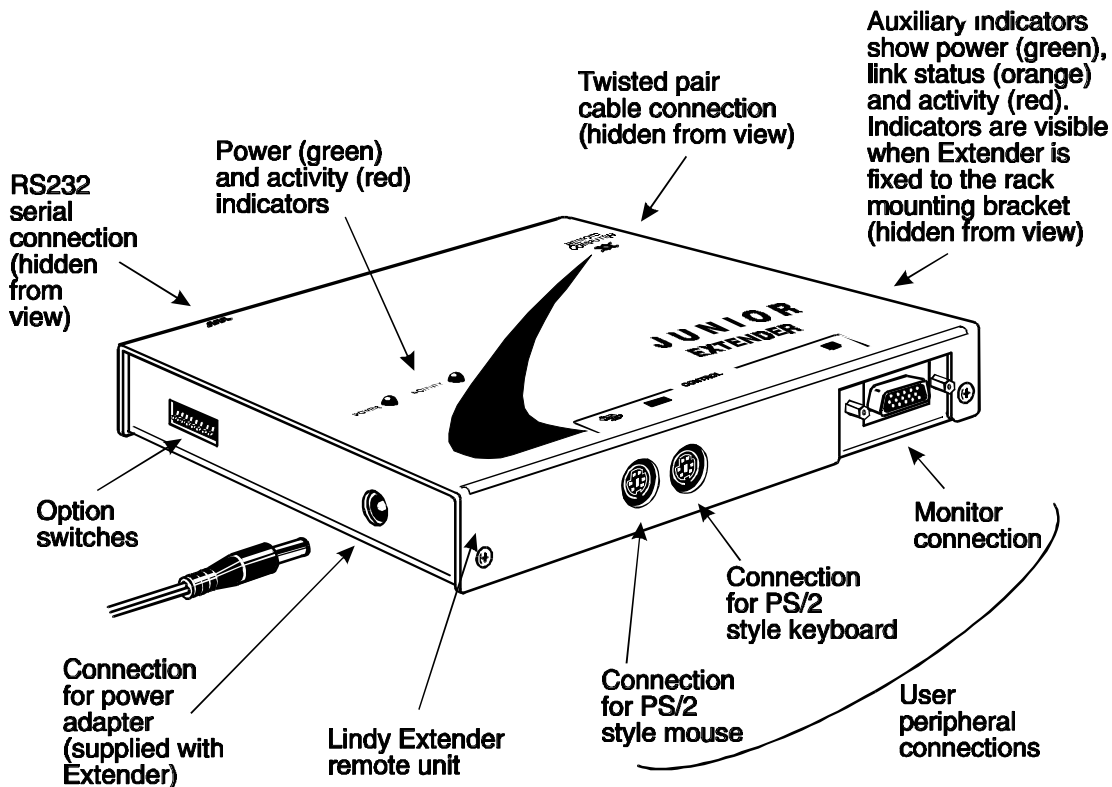

Fig. 3 - LINDY Junior Extender (top) and LINDY Pro Extender (below) receiver units

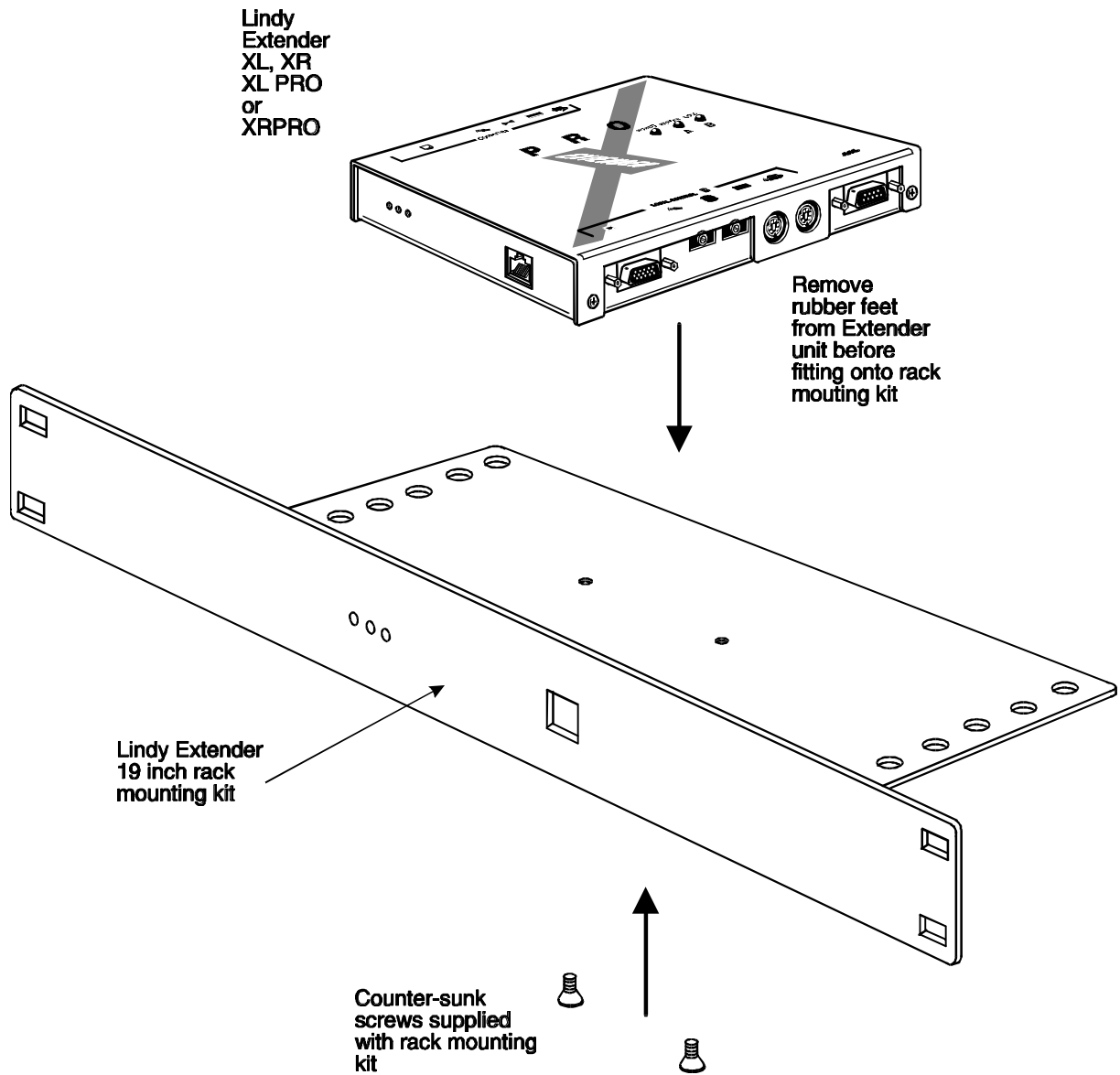

Fig. 4 - Mounting the LINDY Extender into its 19 inch rack mounting bracket

2. Installation

LINDY explains:

Flexible configuration

The LINDY Dual/Quad PRO has many ports for connection to computers, keyboards, mice, monitors and LINDY Link extenders. There are no restrictions placed upon which ports are connected to devices and you can leave any of the ports disconnected if you wish. You do not need to connect a keyboard, monitor and mouse to each user port if you do not wish to use all of these. You may perhaps decide to connect just a keyboard and monitor or you may decide to connect to just one user port. All of these configurations are supported. What's more, your devices do not all need to be of the same type. You may wish to use a large high-resolution monitor with an extended keyboard and a wheel mouse on one user port and a smaller monitor with a basic mouse and keyboard on another. The LINDY Dual/Quad PRO intelligently handles these mixtures of devices.

2.1 What you will need

For the computer connections you will need:

- Cables to connect the LINDY Dual/Quad PRO to each of your computer keyboard, video and mouse ports. Cable specifications are given in appendix A. LINDY 3-in-1 keyboard / video / mouse combination cables are particularly recommended for neatness, convenience and video quality. (You do not need to connect a mouse cable if you are not using the mouse).

- A suitable mouse driver for your PCs. Supported types are:
 - PS/2 or RS232 two button mouse driver (any manufacturer).
 - Microsoft mouse driver (including IntelliMouse).
 - Logitech mouse driver (including two button, three button and wheel mouse).
 - General mouse drivers that are supplied with the operating system.

For the local user port connections you will need:

- A monitor with a standard VGA-style 15-pin analogue video connector that will work when connected directly to each of your PCs. LINDY Dual/Quad PRO supports low and high resolution monitors.

- A PS/2 or AT style keyboard. If you are using an AT keyboard with a 5-pin connector you may connect this to the LINDY Dual/Quad PRO using a standard AT to PS/2 keyboard adapter. LINDY Dual/Quad PRO supports standard keyboards and keyboards with extra media control and Internet navigation keys.
- All LINDY PS/2 Mice and PS/2 style two or three button Microsoft or Logitech compatible mouse or a Microsoft IntelliMouse compatible mouse. If you wish to use the mouse to switch the LINDY Dual/Quad PRO's channel then you will need a three button mouse or an IntelliMouse.

(The LINDY Dual/Quad PRO supports 'Internet / scroll mice' that are compatible with the Microsoft IntelliMouse. These are fitted with a wheel or other scroll control and sometimes have additional buttons. Examples are: Microsoft IntelliMouse, Logitech Pilot Mouse+, Logitech MouseMan+, Genius NetMouse and Genius NetMouse Pro.)

For the integrated LINDY Extender ports you will need:

- An LINDY Junior Extender or LINDY Pro Extender receiver. These receivers are not provided with the LINDY Dual/Quad PRO and may be purchased separately. The LINDY transmitter unit is built in to the LINDY Dual/Quad PRO.
- A suitable twisted pair cable that runs from the LINDY Dual/Quad PRO to the location where you wish to locate your remote keyboard, video monitor and mouse. The LINDY Dual/Quad PRO built-in extender uses the same type of cable that is commonly used for Ethernet networks. This type of wiring is often installed into buildings and terminated at wiring sockets in various locations. If you have this type of wiring then you will just need to run a standard network-style patch cable between the wiring socket and the LINDY Dual/Quad PRO at one end and between the wiring socket and the LINDY extender at the other end.

IMPORTANT WARNING

Do not connect the CPU Switch's extender ports to an Ethernet hub or other digital network device. The signals carried on the twisted pair cable between the CPU Switch and the Lindy Extender are ANALOGUE. Plugging the CPU Switch or Lindy Extender into a digital network device such as a hub may damage you devices

Use of PS/2 and RS232 style mice with the LINDY Dual/Quad PRO - All of the mouse connections from LINDY Dual/Quad PRO to PCs support either a PS/2 or an RS232 mouse. LINDY Dual/Quad PRO automatically converts from the PS/2 mouse commands to RS232 serial mouse commands. Serial mice types are selected by using an adapter as described in Appendix A. The LINDY Dual/Quad PRO will operate without a mouse connected if you do not wish to use one.

2.2 Mounting the LINDY Dual/Quad PRO

The LINDY Dual/Quad PRO has been designed to be used either on a desktop or mounted in a 19 inch rack. If the LINDY Dual/Quad PRO is to be used on a desktop then you will need to stick the supplied self-adhesive rubber feet to the underside of the LINDY Dual/Quad PRO. If the LINDY Dual/Quad PRO is to be mounted in a 19 inch rack then you will need to fit the rack mounting brackets to the side of the LINDY Dual/Quad PRO. Do this using the brackets and screws provided.

2.3 Connecting your devices

Ensure that the power is disconnected from the LINDY Dual/Quad PRO and all devices which are to be attached. Connect any local keyboards, monitors and mice to the user port connectors at the rear of the LINDY Dual/Quad PRO (see figure 2). The user ports are coloured white and the individual connectors are colour coded for your convenience. If you are connecting several KVM (Keyboard, Video monitor, Mouse) sets then you do not need to use the same brands or mix of devices on each user port.

User ports 1 and 3 are dual access ports and may have both a local KVM (connected directly) and a remote KVM (connected via and LINDY extender) attached at the same time. The local and remote KVM's share the port on a timeout basis but only one KVM may be using the port at any one time. If you are not using all the local KVM connections it is preferable to connect the KVM's to ports that are not shared with the LINDY so that these KVM's have fully independent access to the LINDY Dual/Quad PRO.

Next connect each computer system unit in turn with the keyboard cable, mouse cable and video cable. LINDY 3-in-1 keyboard/video/mouse cables are recommended for maximum convenience and video quality. Remember that the video quality is maximised if the cables are kept as short as possible. Where

possible, 2 metre cables are recommended as these will give very high video quality. Any unused computer connections can be left unconnected. To connect computers with serial mouse connections and AT style keyboard connections use the adapters specified in appendix A. If you have an existing 6-pin mini-DIN to 9-pin serial adapter that came with a mouse it may not be suitable for use with the LINDY Dual/Quad PRO as there are several different standard wiring configurations for these adapters.

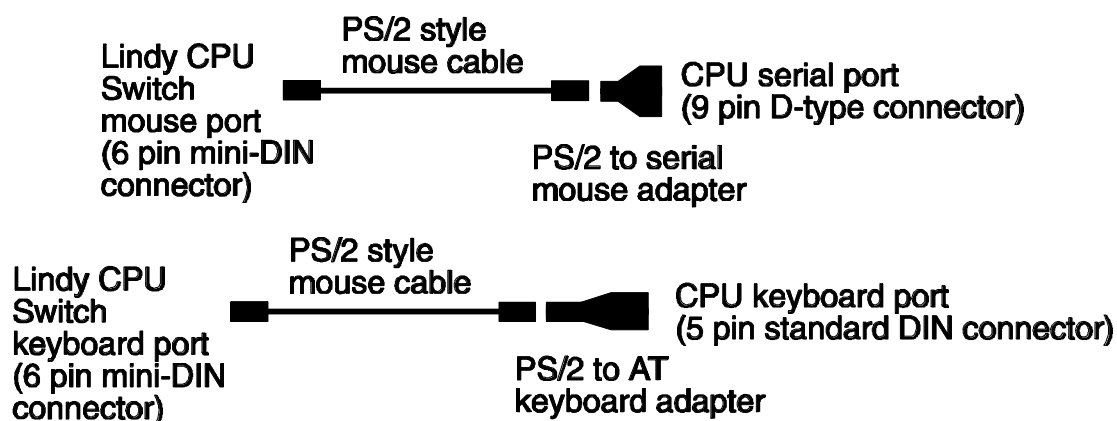

The LINDY Dual/Quad PRO is now ready for connection to the mains using the mains power adapter supplied. It is important to apply power to the LINDY Dual/Quad PRO first, then power on the monitor and each of the computers in turn. Failure to switch the LINDY Dual/Quad PRO and computers on in the correct order can lead to the mouse and/or keyboard not being recognised by the computers when they are switched on.

You may attach the power adapter to either power inlet A or power inlet B (see figure 2). These ports are both the same and are provided to enable you to connect a redundant (spare) power supply (see section 4.2 for more details). Connect your power adapter to either of the power inlet ports to power on the LINDY Dual/Quad PRO. There is no ON/OFF switch and the LINDY Dual/Quad PRO will start to operate as soon as the power is applied.

2.4 Configuring your PCs

Configure your PC in the same way that you would if your keyboard, mouse and monitor were all connected directly to your PC, but bearing in mind the following point:

- LINDY Dual/Quad PRO emulates Microsoft compatible serial, IntelliMouse and

PS/2 mice, so ensure that your PC software is configured for a Microsoft mouse of the correct type. Refer to the list of supported drivers in section 2.1.

2.5 Structuring your LINDY Dual/Quad PRO installation

A single LINDY Dual/Quad PRO 16 may be used to manage and control up to 16 computers (see figure 5). For larger numbers of computers, Dual/Quad PRO units may be cascaded in a tree structure to form a video switching network (see figure 6). The LINDY Dual/Quad PRO unit at the top of this tree structure is normally used to control all the cascaded LINDY Dual/Quad PRO's although other configurations are possible.

The LINDY Dual/Quad PRO is fitted with an intelligent communication system that enables it to detect and communicate with other LINDY Dual/Quad PRO's so that it is able to positively verify that all the cascaded LINDY Dual/Quad PRO's have correctly responded to a switching request from the user. The LINDY Dual/Quad PRO's communicate with each other via the keyboard cables.

LINDY Dual/Quad PRO may be cascaded in a very flexible manner. Either 1, 2, 3 or 4 links may be made between cascaded LINDY Dual/Quad PRO's. The number of independent users supported by the system is determined by the number of cascade links that have been installed. If only two cascade links are made then only two users have simultaneous access to ports on the cascaded LINDY Dual/Quad PRO's. The LINDY Dual/Quad PRO intelligently manages the cascade links and allocates them on a first come first served basis rather like a telephone network.

LINDY Dual/Quad PRO may also be cascaded to single user LINDY Dual/Quad PRO products with the restriction that the LINDY Dual/Quad PRO units must be on the last layer of the tree and that no further units are cascaded off these.

When cascading LINDY Dual/Quad PRO keep in mind the following rules

- The maximum number of layers in a LINDY Dual/Quad PRO cascade is four.
- You may cascade 4 units with 1, 2, 3 or 4 KVM links and 2 units with 1 or 2 KVM links. The number of KVM links that you install defines the number of simultaneous uses that are supported.
- Keep all cascade cables as short as possible. The video quality is maximised by using the shortest possible total cable run from computer to KVM.

- If you are making multiple cascade links between LINDY Dual/Quad PRO then ensure that the cables are approximately the same length.
- LINDY Dual/Quad PRO devices may be cascaded to cascades but the Pro units must always be on the lowest level of the cascade (in other words you must not cascade an device off a Pro device)
- LINDY Dual/Quad PRO 4, 8, 12 and 16 models may be cascaded together.
- You must choose groups of cascade ports from the following table. When you cascade using a group of ports the system will allocate the first available free port in that group (see section 4.10 and 4.16 for more details)

All ports may be used as a single cascade link	Possible groups of ports for dual cascade links and their associated group numbers	Possible groups of ports for tripple cascade links and their associated group numbers	Possible groups of ports for quadruple cascade links and their associated group numbers
	PORT GROUP	PORT GROUP	PORT GROUP
1	1 } 21	1 } 31	1 } 41
2	2 } 21	2 } 31	2 } 41
3	3 } 22	3 } 31	3 } 41
4	4 } 22	4 } 32	4 } 42
5	5 } 23	5 } 32	5 } 42
6	6 } 23	6 } 33	6 } 42
7	7 } 24	7 } 33	7 } 43
8	8 } 24	8 } 34	8 } 43
9	9 } 25	9 } 34	9 } 44
10	10 } 25	10 } 35	10 } 44
11	11 } 26	11 }	11 }
12	12 } 26	12 }	12 }
13	13 } 27	13 }	13 }
14	14 } 27	14 }	14 }
15	15 } 28	15 }	15 }
16	16 } 28	16 }	16 }

The following diagrams show some typical LINDY Dual/Quad PRO installations.

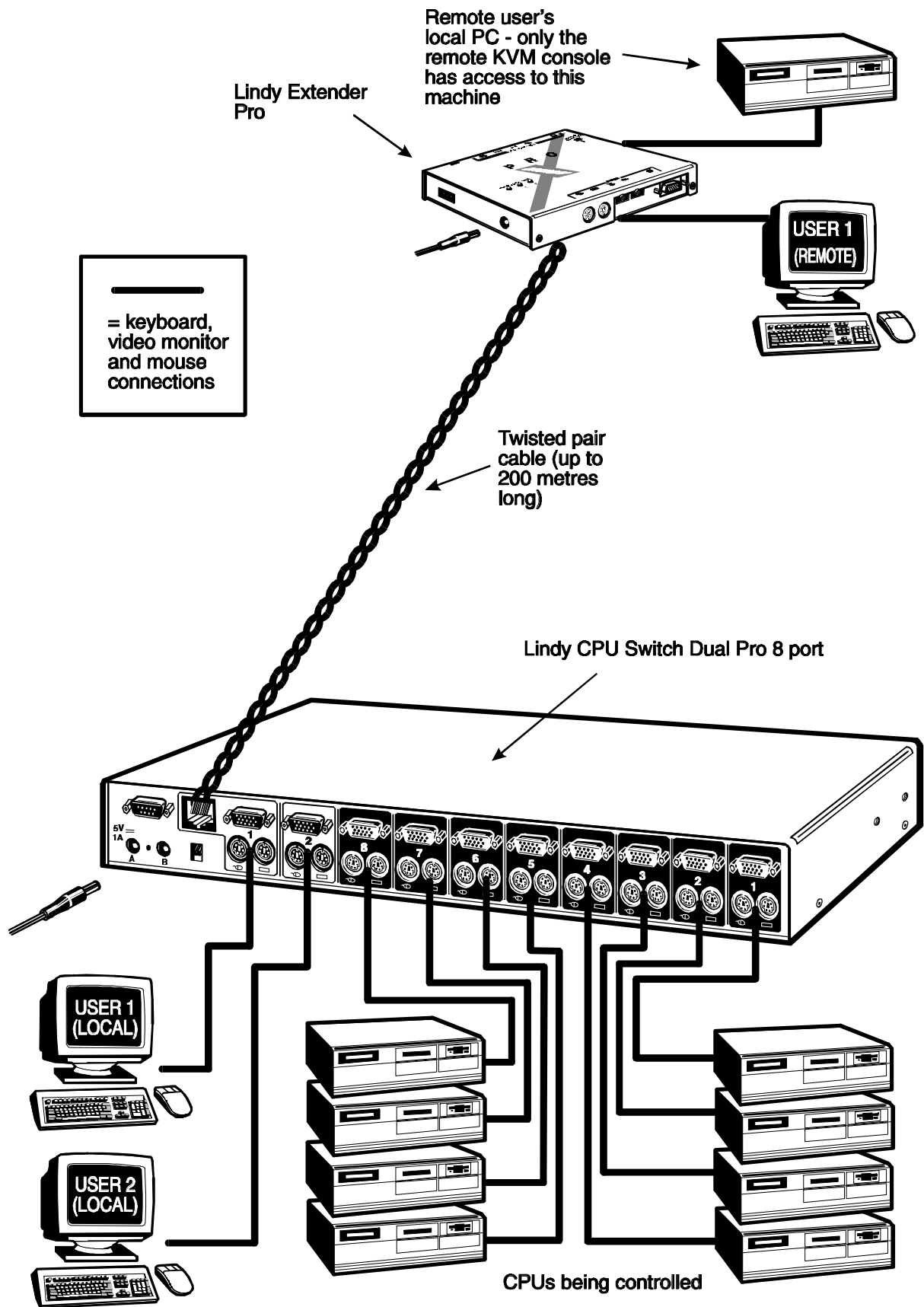

Fig. 5 - A typical installation using a single LINDY Dual/Quad PRO 8 Port

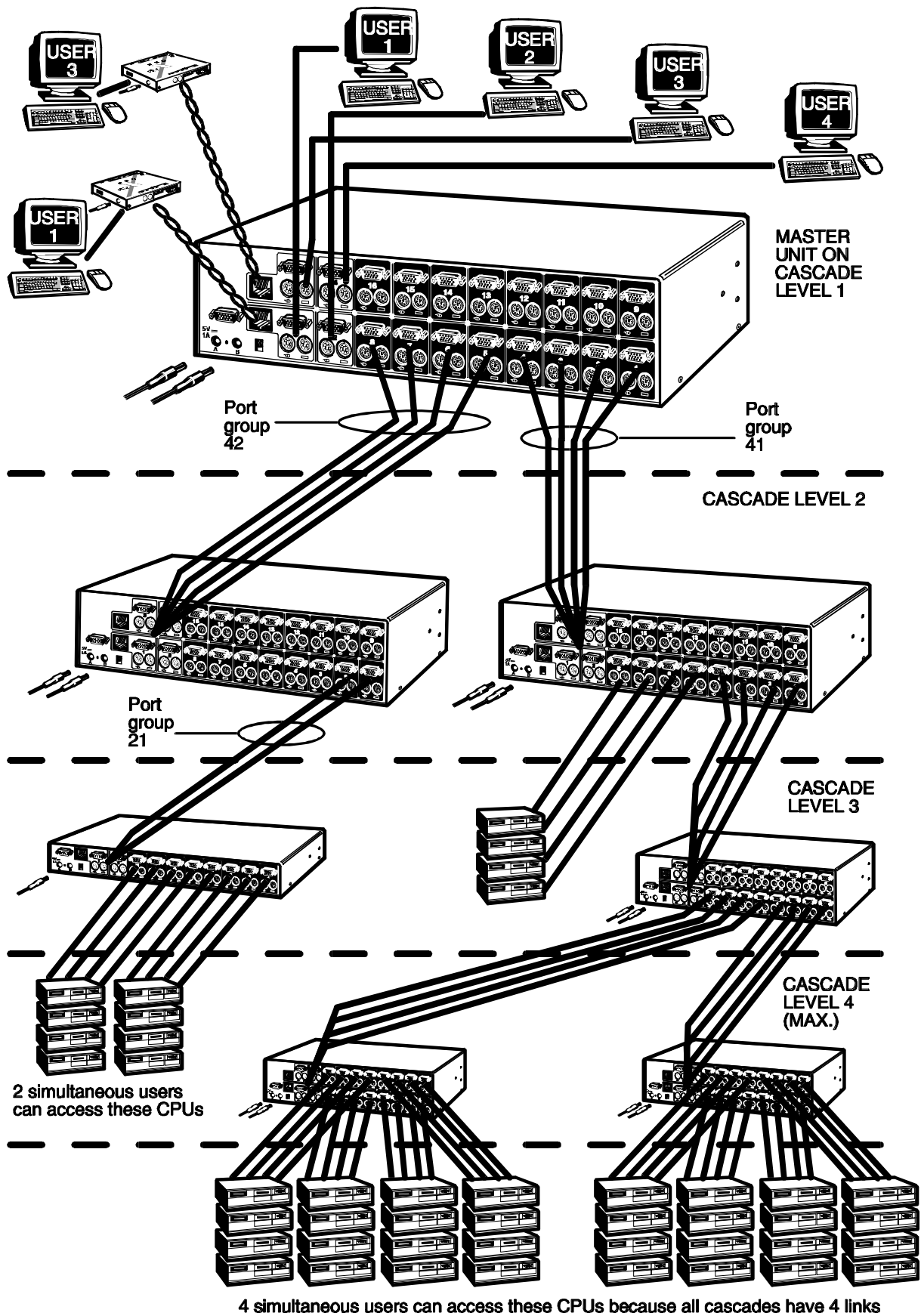

Fig. 6 - A cascaded application using multiple LINDY Dual/Quad PRO

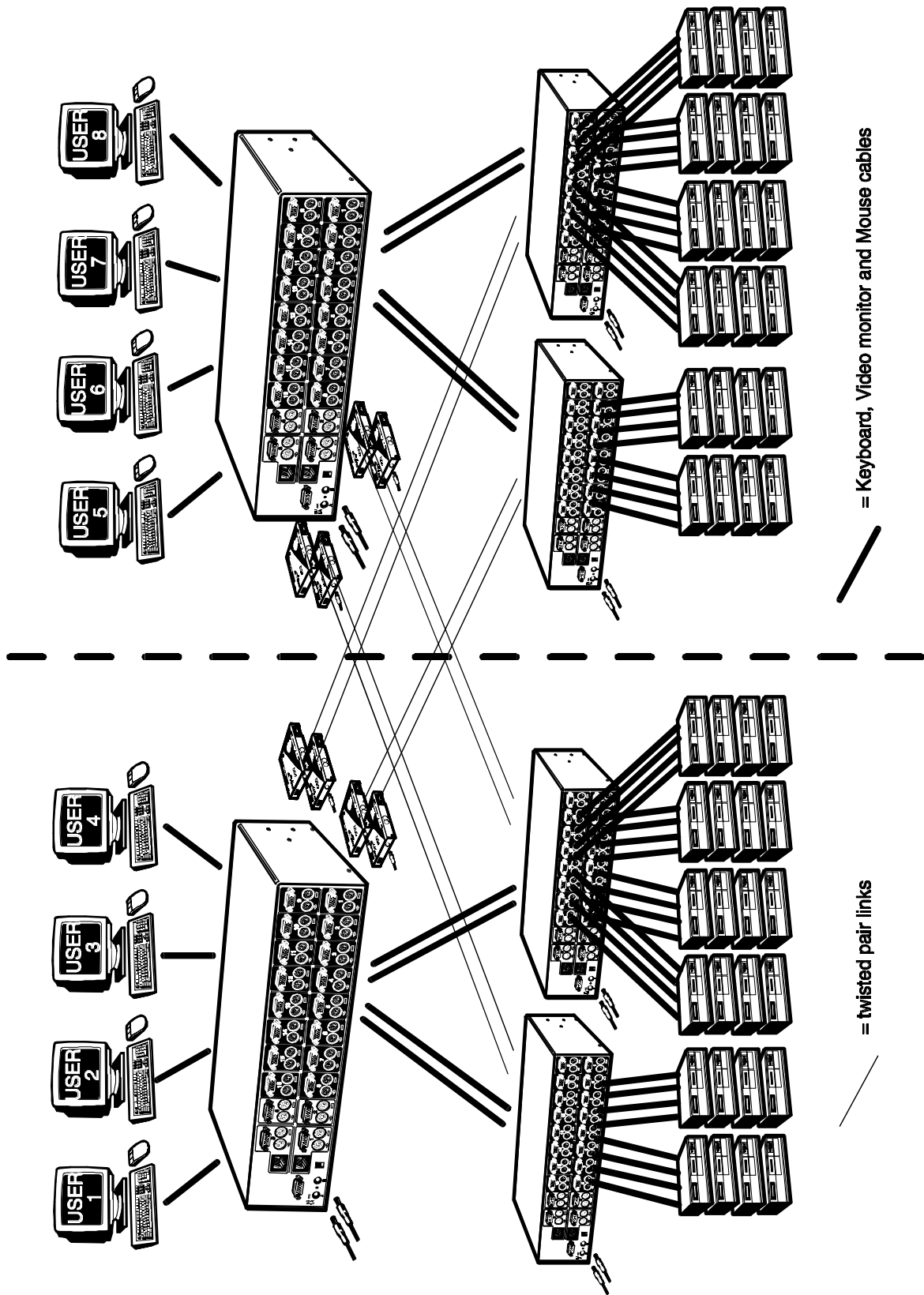

Fig. 7 – An advanced application that uses two sets of cascaded LINDY Dual/Quad PROs

2.6 Maximising the video quality

The LINDY Dual/Quad PRO supports very high bandwidth video signals and resolutions up to 1900 x 1440 pixels. It regenerates the video signals using wide band amplifiers in order to minimise any loss of video quality. All video cables introduce distortion onto the video signal. For short cables this is minimal but for longer cables the loss of quality can start to become noticeable particularly at higher video resolutions. To maximise the video quality of your LINDY Dual/Quad PRO installation we recommend the following:

- Use the shortest possible video cables between your devices. High quality two metre long cables such as the LINDY 3-in-1 combination cable will give excellent results.
- Avoid using cables with 15-pin D-type connectors that are not specifically designed to carry video signals - you will see a picture but the quality will be truly appalling with smudging, ghosting and loss of focus. Cables that are designed to carry video signals are constructed using three separate co-axial cores to carry the red, green and blue signals. These co-axial cores make the cable thick like the cable that you see coming out of the back of a monitor. Typically this cable will be 8.5 to 9 mm in diameter. If your cable is thin (say 6mm in diameter) or does not look like the cable you would expect to see coming out of a monitor then it may well be an unsuitable 'data' cable. Such cables are only suitable for very low resolution DOS-style screens.
- Where possible use a single cable of the correct length rather than multiple extension cables. If you must use an extension cable then make sure that it is a cable that is specifically designed to carry video signals.
- When cascading LINDY Dual/Quad PRO's use the shortest possible cables between units. Structure the installation so that the maximum cable run between computers and KVM's is minimised. If possible keep this distance to below 30 metres (100 feet).
- For longer distances use the LINDY extender.

2.7 Other useful installation information

PC boot up sequence - When your PCs are powered on they communicate with any attached keyboards and mice and setup parameters required by the particular operating system. It is necessary for the LINDY Dual/Quad PRO to be attached and powered on during this sequence so that it can give the required responses and keep track of all the modes and settings requested by each of the connected PCs.

Mouse characteristics - do not unplug a PS/2 mouse connection from a PC whilst the PC is on. Due to the design of PS/2 mice communications the mouse function on the PC will be lost and you will have to re-boot the PC to regain normal operation. Unplugging the mouse from the LINDY Dual/Quad PRO will also cause it to stop operating when it is plugged back in. RS232 mice can usually be unplugged and plugged back in provided that a mouse was connected when the operating system initially booted. The LINDY Dual/Quad PRO is fitted with a PS/2 mouse recovery system which allows you to disconnect and re-connect the shared mouse without powering down the system (although this is generally not advisable) - see section 2.8 for details.

Keyboard and mouse mode switching - The LINDY Dual/Quad PRO keeps a log of the keyboard and mouse mode and resolution settings requested by each of the connected PCs. These settings are automatically restored to the shared keyboard and mouse when the LINDY Dual/Quad PRO channel is switched thus ensuring maximum software compatibility. The keyboard num, caps and scroll lock states are an obvious example of this process.

2.8 Re-enabling a disconnected PS/2 mouse

If you disconnect the shared PS/2 mouse from the LINDY Dual/Quad PRO by accident during operation then the mouse operation will be lost when the mouse is plugged back in. To avoid having to reboot the entire system in this situation the LINDY Dual/Quad PRO is fitted with an automatic mouse recovery system.

With the PS/2 mouse disconnected, change the channel using the keypad or keyboard hotkeys. The LINDY Dual/Quad PRO detects that the mouse has been disconnected and triggers the automatic recovery system. Plug in the PS/2 mouse and the LINDY Dual/Quad PRO will re-initialise it.

Alternatively you can reset the keyboard and mouse for a given user port by using the LINDY Dual/Quad PRO's keyboard and mouse reset function (see section 4.17). This function only resets the keyboard and mouse attached to the selected user port. It does not affect the status of any of the LINDY Dual/Quad PRO's other ports or the CPU connections.

2.9 Hot plugging the LINDY Dual/Quad PRO into running systems and re-enabling disconnected CPU PS/2 mouse connections

It is advisable to switch off the systems that are going to be connected to the LINDY Dual/Quad PRO before installation. However if this is not possible then most systems can be hot plugged by using the LINDY Dual/Quad PRO's mouse restoration functions. The keyboard connection will normally restore itself automatically.

On many PCs, mouse movement will be lost if the PS/2 mouse is unplugged and plugged back in whilst the PC is running. Mouse movement can then only be restored by rebooting the PC. This is because the mouse drivers only setup and enable the mouse when the PC is initially booted.

If you have switched off your LINDY Dual/Quad PRO or you are attempting to 'hot plug' it into a system that is already running, you may be able to restore lost mouse movement using the LINDY Dual/Quad PRO's mouse restoration functions.

Mouse restoration functions should be used with care as unpredictable results may occur if the wrong mouse type is selected. If in doubt restore the mouse by powering down the PC normally.

Standard PS/2 mouse data uses a different data format to IntelliMouse data and so two reset functions are provided on the LINDY Dual/Quad PRO. The type of data format expected by the PC depends upon the driver and the type of mouse that was connected when the driver was booted. The following table may be used as a guide. Note that the mouse reset functions predict the likely mouse resolution settings but may not restore the speed or sensitivity of the mouse exactly as they were when the PC originally booted.

Type of mouse / system Connected at bootup	Driver type	Likely expected data format	Suggested restoration
PS/2	PS/2 only	PS/2	Standard
PS/2	IntelliMouse	PS/2	Standard
IntelliMouse / LINDY Dual/Quad PRO	PS/2 only	PS/2	Standard
IntelliMouse / LINDY Dual/Quad PRO	IntelliMouse	IntelliMouse	IntelliMouse

To restore lost mouse movement on a CPU connected to the LINDY Dual/Quad PRO:

- 1) Select the CPU that has lost its mouse movement
- 2) Activate the on-screen menu using the keyboard hotkeys
- 3) Press F1 to view additional menus
- 4) Select the FUNCTIONS menu
- 5) Select RESTORE STANDARD MOUSE or RESTORE INTELLIMOUSE
- 6) Exit the on-screen menu

3. Configuring the LINDY Dual/Quad PRO

3.1 Configuration summary

The LINDY Dual/Quad PRO is configured using the on-screen menu system which is activated by default when you first power on the system. It may also be accessed by using the keyboard 'hotkeys' (see section 4.8) or by using the LINDY Dual/Quad PRO's front panel keys (see section 4.6). The following steps summarise a typical configuration process. For more advanced information on each of the configuration steps please refer to the appropriate sections of this manual shown in brackets.

Note: The LINDY Dual/Quad PRO is configured via the ADMIN user account. The LINDY Dual/Quad PRO will allow multiple users to be logged in under the ADMIN account but will only allow one of these users to be adding or editing computer names or user profiles or setting global and setup options at any one time.

Step 1 - Decide if you are going to use password security

The LINDY Dual/Quad PRO may be run with security enabled or disabled. With security disabled, all user ports have full access to all of the computers and full administration rights. The LINDY Dual/Quad PRO is shipped to you with security disabled. This mode is suitable for simple installations with a small number of users. Larger installations or systems with larger numbers of users will require password security to be enabled. In this mode, each user logs on to the system and is allocated access rights to defined computers by the system administrator. This mode is recommended for most systems (see section 3.2 for details on how to enable security). If you are not using security the go to step 4.

Step 2 - Create an ADMIN (administration) account password

The LINDY Dual/Quad PRO has a fixed user account that cannot be deleted named ADMIN. This user account is the only one that is able to make important system changes. If you are going to be using security then you should allocate a password to this account (see section 3.3 for instructions).

Step 3 - Create user accounts

Login to the LINDY Dual/Quad PRO using the ADMIN account and add user profiles and passwords for each of the system users (see section 3.4). The LINDY Dual/Quad PRO supports up to 16 user profiles.

Step 4 - Add / edit names to identify your computers

Whilst you are logged into the LINDY Dual/Quad PRO using the ADMIN account, create names for each of the computers that you have attached to the system. The LINDY Dual/Quad PRO creates default names for each of its ports (Computer 1 to Computer 16). These default names may be edited as required. Whilst adding the computer names you can define which users will have access to each computer. Each computer has an associated 8 digit port number which defines its location. If you are using a single LINDY Dual/Quad PRO then all the computers will have two digit port numbers (01 to 16). If you are cascading LINDY Dual/Quad PRO's then each computer will have a four, six or eight digit port number depending on the number of cascade levels that have been connected (see section 4.10 for details). The LINDY Dual/Quad PRO supports up to 512 computer names although special versions are available that support more names.

Step 5 - Set the required SETUP OPTIONS and GLOBAL PREFERENCES

Use the ADMIN account to select the required SETUP OPTIONS and GLOBAL PREFERENCES. The SETUP OPTIONS menu is used to configure important system operating parameters such as security mode, language, hotkeys and control options. The GLOBAL PREFERENCES menu is used to select various timing characteristics and other options.

3.2 Enabling password security

The LINDY Dual/Quad PRO may be operated with or without security enabled. With no security all users will have full administration rights and full access to all the connected computers. For systems with several users this may not be desirable. System security is enabled using the on-screen menu. The on-screen menu is activated automatically when you first switch on the LINDY Dual/Quad PRO but may also be selected using the keyboard hotkeys (see section 4.8) or the front panel controls (see section 4.6).

To switch on the password security system:

- From the main on-screen menu press **F1** for **MORE MENUS**.
- Select **SETUP OPTIONS** from the menu.
- Move the menu bar over the **SECURITY** option.
- Press **SPACE BAR** to enable security.
- Press **ESC** to quit from the menu.

3.3 Setting an ADMIN password

The LINDY Dual/Quad PRO supports up to 16 user profiles. The administrator of the system can grant or deny users access to any of the connected computers and has complete control over the setup of the system. The administrator accesses the system via a special user named ADMIN. This profile may not be altered or deleted from the system and has full access rights to all computers and system parameters. Consequently it is advisable to set a password for this user.

To set a password for the ADMIN user:

- From the main on-screen menu press **F1** for **MORE MENUS**.
- Select **EDIT USER LIST** from the menu.
- Move the menu bar over the **ADMIN** user.
- Press **RETURN** or **ENTER** to edit the ADMIN user.
- Press **RETURN** or **ENTER** again to edit the ADMIN user's password.
- Make sure that the password you want is displayed.
- Press **RETURN** or **ENTER** to save the password.
- You will now see the "Edit Access Rights" menu. The ADMIN user always has access to all the computers. Press **RETURN** or **ENTER** again to quit from this menu.

3.4 Creating and editing user accounts

To create user accounts:

- Ensure that you are logged on as the ADMIN user.
- From the main on-screen menu press **F1** for **MORE MENUS**.
- Select **EDIT USER LIST** from the menu.
- Press **INSERT** to add a new user.
- Type in the name of the new user and press **RETURN** or **ENTER**.

- Type in the password for the new user and press **RETURN** or **ENTER**.
(You may leave the password field blank if you do not want to define a password)
- Define the computers that you want this user to have access to using the **SPACE BAR** and function keys as directed on the menu. The user will have access to all the starred (selected) computers. Don't worry if all the computers have not yet been defined. You can allocate users access to computers when you add the computer names later.
- Press **RETURN** or **ENTER** to create the user.

Follow a similar process to edit users:

In the **EDIT USER LIST** use the menu bar to select the user that you want to edit. Press **ENTER** or **RETURN** to edit the user's name, password and access rights. Press **RETURN** or **ENTER** if you want to keep the existing entries.

3.5 Creating and editing computer names

Computer names provide a very convenient way of selecting and identifying computers that are attached to the LINDY Dual/Quad PRO. You can select computers by port number (see sections 4.8 and 4.16) but when you have several computers it becomes hard to remember which computer is attached to which port. By defining descriptive computer names you can select the required computer from an on-screen menu without having to remember which physical port the computer is connected to. For each computer name that you define you can grant or deny access to any of the defined users.

Each computer name that you define will have an associated port number. This is the LINDY Dual/Quad PRO port that the computer is attached to. If all of your computers are connected to a single LINDY Dual/Quad PRO then all the port numbers will be two characters long (for example: 01, 02, 03, 16 etc.). If you are cascading LINDY Dual/Quad PRO then the port numbers will be four, six or eight characters long depending upon whether you have two, three or four levels of cascade (see figure 7). See the end of this section and section 4.10 for an explanation of how the port numbers are constructed. The LINDY Dual/Quad PRO supports up to 512 computer names.

To create computer names:

- Ensure that you are logged on as the ADMIN user.
- From the main on-screen menu press **F1** for **MORE MENUS**.
- Select **EDIT COMPUTER LIST** from the menu.
- Press **INSERT** to add a new computer name.
- Type in the name of the computer and press **RETURN** or **ENTER**.
- Type in the port number for this computer and press **RETURN** or **ENTER**.
- Define the users that you want user to have access to this computer the **SPACE BAR** and function keys as directed on the menu. The starred users will have access to this computer. Don't worry if all the users have not yet been defined. You can allocate computers to users when you add the users later.
- Press **RETURN** or **ENTER** to create the new computer name.

When you are adding computers it is advisable to setup just one name for any particular port. Avoid creating two names for the same port as this can lead to confusion. Also, if you are using ports to cascade to other LINDY Dual/Quad PRO's, avoid setting up unique names for individual ports that form part of a group of ports that are being used to cascade. For example, if you are using group 41 (ports 1,2,3 and 4) to cascade to another LINDY Dual/Quad PRO then avoid setting up individual names for these ports.

Follow a similar process to edit computer names:

In the **EDIT COMPUTER LIST** use the menu bar to select the computer that you want to edit. Press **ENTER** or **RETURN** to edit the computer's name or change the users who you want to have access to this computer. Press **RETURN** or **ENTER** if you want to keep the existing entries.

Creating entries for computers connected to cascaded LINDY Dual/Quad PRO's

You can cascade LINDY Dual/Quad PRO 4 units using one, two, three or four KVM links and LINDY Dual/Quad PRO 2 units using one or two KVM links. Section 2.5 explains the rules that you must follow when installing a LINDY Dual/Quad PRO cascade. The number of cascade links that you install determines the number of simultaneous users that can access computers on the cascaded LINDY Dual/Quad PRO's. Ideally if you are cascading 4 units then you should use four cascade links as this will cause no blocking and will allow all four users simultaneous access to all computers.

Each computer name that you add to the on-screen menu has an associated port number that tells the LINDY Dual/Quad PRO where to find the computer. Port numbers for computers attached to a single LINDY Dual/Quad PRO are simply the port number that the computer is attached to. Port numbers for computers connected to cascaded LINDY Dual/Quad PRO's are constructed by defining the port routing that is required to get from the user's KVM to the computer.

Figure 7 illustrates how port numbers are constructed and how the physical configuration of a cascaded system relates to entries in the on-screen menu. The illustrated configuration is an unlikely configuration in practice but has been chosen for explanation purposes. If you make multiple cascade links then they must be connected to the groups of ports defined in figure 8. These ports have associated group port numbers. The LINDY Dual/Quad PRO uses this group port number to connect to the first available port in that group. For example, group port number 21 comprises of ports 1 and 2. If these ports are linked to a cascaded LINDY Dual/Quad PRO and users try to connect to computers that are attached to the cascaded LINDY Dual/Quad PRO, the system will allocate the cascade links to the first two users on a first come first served basis. Further users that try to connect to computers on the cascaded LINDY Dual/Quad PRO will get a message saying that no cascade links are available and they will not be able to connect to the cascaded LINDY Dual/Quad PRO until one of the previous users has finished with one of the cascade links.

LINDY QUAD PRO	
Edit Computer List	
Comms Server	09
Technical Server	16
Accounts Server	42423107
Firewall	414105
Internet Gateway	4109
Jim's Computer	424204
Voicemail Server	41422101
Web Server 1	41420301
Ins=Add	Del=Delete
F1=Clone	Enter=Edit
↑ =Select	F3=Find
Esc=Quit	

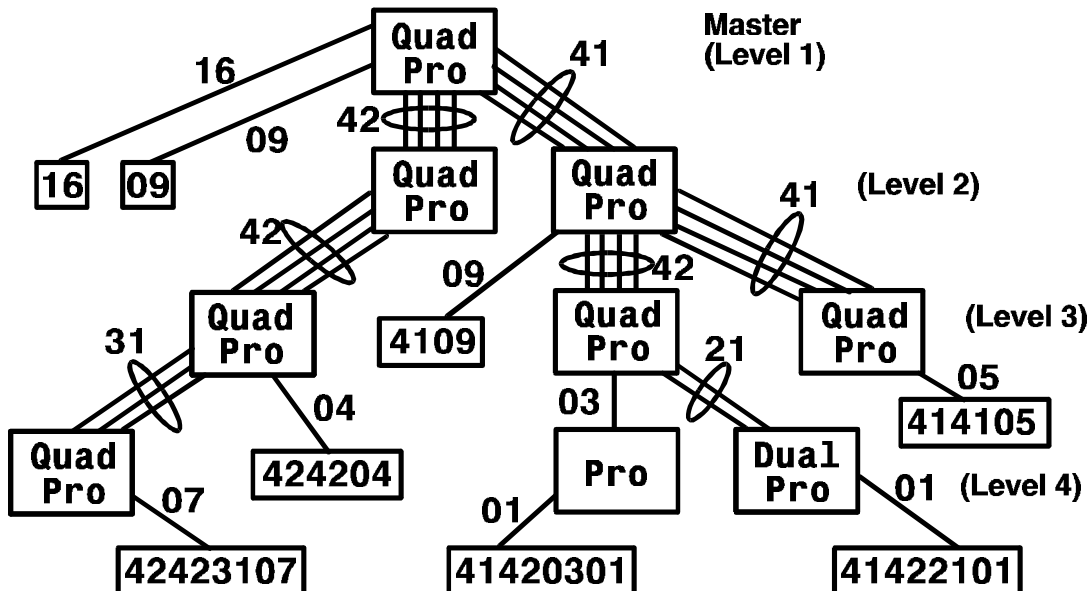
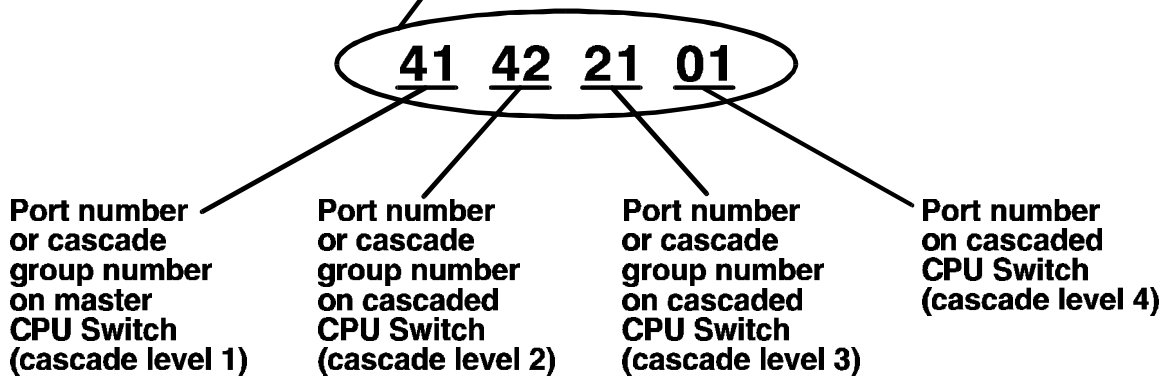

Fig. 7 - Creating menu entries for computers that are connected to cascaded LINDY Dual/Quad PRO's

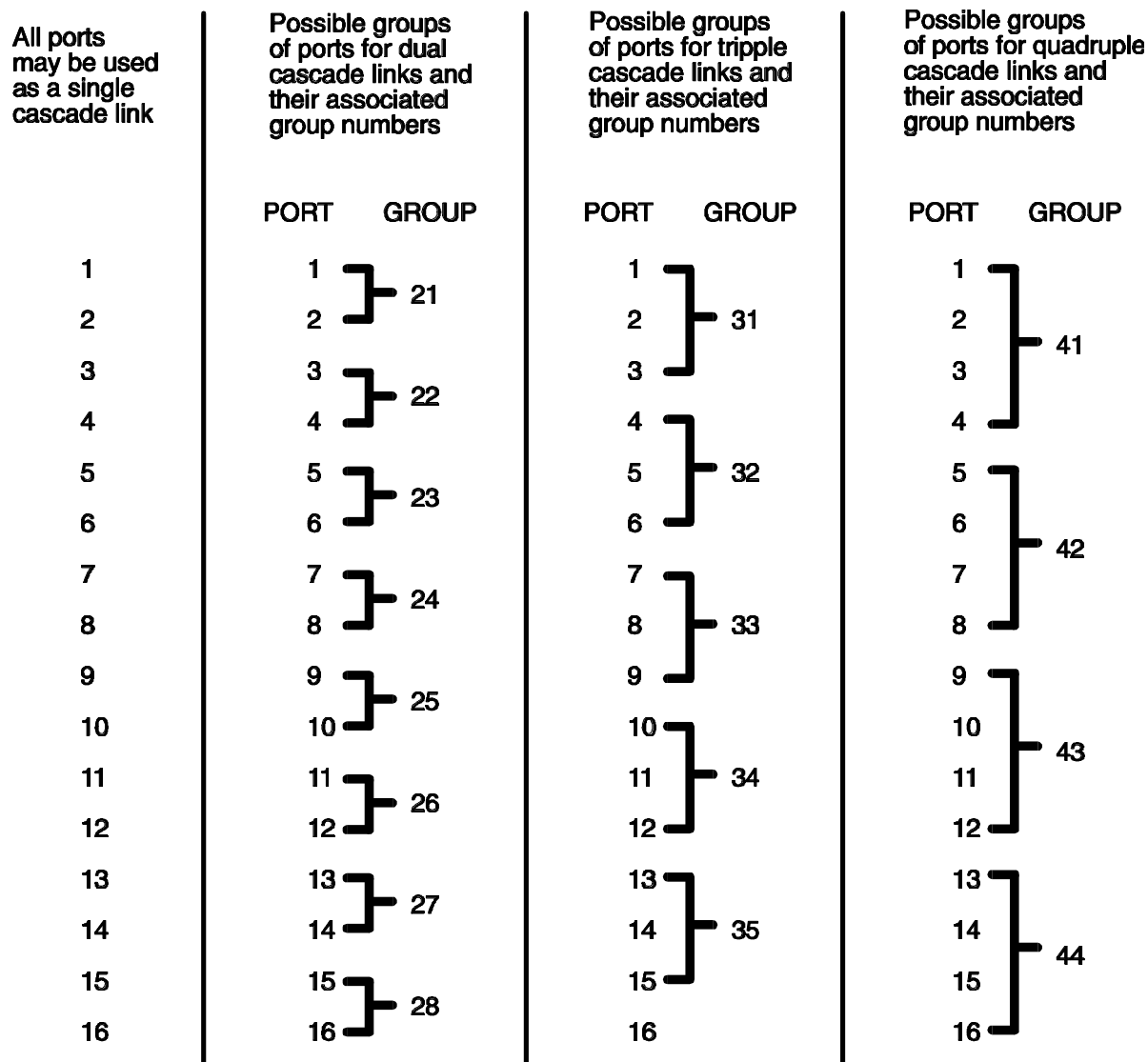

Fig. 8 - Possible cascade groups and their associated names

3.6 Setting the SETUP OPTIONS and GLOBAL PREFERENCES

The **SETUP OPTIONS** and **GLOBAL PREFERENCES** are system operating parameters that apply to the whole system rather than to individual users. These may only be setup or changed by the system administrator logged in using the ADMIN account. From the main menu press **F1** for **MORE MENU**. Use the cursor keys to position the menu bar over **SETUP OPTIONS** or **GLOBAL PREFERENCES**. Press **ENTER** or **RETURN** to view the individual menus. Use the cursor keys to place the menu bar over the required option and then use **SPACE BAR** to change the option as required. Press **ESC** to quit and save the changes.

3.6.1 SECURITY

Accessed from menu: SETUP OPTIONS

Settings: DISABLED, ENABLED

With security disabled there is no requirement for users to login to the system. All users have full access to all the connected computers and full administration rights. With security enabled, users are required to login to the LINDY Dual/Quad PRO. Each user is allocated access rights to computers by the system administrator and they are only able to see the computers that they have access to on their on-screen menu.

3.6.2 LANGUAGE

Accessed from menu: SETUP OPTIONS

Settings: ENGLISH, FRENCH, GERMAN

This option specifies the language that is used for the on-screen menu and the keyboard layout that is assumed for the keyboard. When the French option is selected the keyboard is assumed to have an AZERTY format. When the English and German options are selected the keyboard is assumed to have a QWERTY format. The new language settings are enabled when you quit from the SETUP OPTIONS menu. The language option **only affects** the way that the CPU Switch interprets the keyboard keys, it does not affect the way that the computers interpret the keyboard. It is advisable to avoid setting a language that you do not understand as all the menus will change to use the new language and you may have difficulty reselecting your original language.

3.6.3 HOTKEYS

Accessed from menu: SETUP OPTIONS

Settings: CTRL+ALT, CTRL+SHIFT, ALT+SHIFT, ALT GR, LEFT ALT+RIGHT ALT, LEFT CTRL+LEFT ALT, RIGHT CTRL+RIGHT ALT, DISABLED

The keyboard hotkeys are special combinations of keys that, when used together with certain keyboard "command keys", perform special LINDY Dual/Quad PRO functions. For example, pressing the hotkeys together with the "M" key will cause the on-screen menu to be displayed on your monitor. Other hotkey combinations allow you to query which computer you are connected to and to move the on-screen menu around the screen. You can also use the hotkeys together with the port

number to quickly select a chosen computer without activating the on-screen menu. See section 4.8 for full details on using keyboard hotkeys to control the LINDY Dual/Quad PRO. We do not normally recommend that you disable the hotkeys but if you choose to do this then you will need to access the on-screen menu using the LINDY Dual/Quad PRO's front panel controls.

3.6.4 KEYPAD CONTROLS

Accessed from menu: SETUP OPTIONS

Settings: ENABLED, DISABLED

The key controls on the front of the LINDY Dual/Quad PRO may be disabled so that it is only possible to select the special channels "o" and "0" (the on-screen menu and the non-existent channel zero).

3.6.5 EXCLUSIVE USE

Accessed from menu: SETUP OPTIONS

Settings: ALLOWED, DISABLED

In normal operation, the LINDY Dual/Quad PRO will allow two or more users to share access to a computer. In this mode, the computer's video picture will be displayed on all the user's monitors but only one user may have active control of the computer's keyboard and mouse at any one time. The LINDY Dual/Quad PRO detects an active user by looking for keyboard and mouse data. A user becomes inactive if no keyboard or mouse data has been received by the LINDY Dual/Quad PRO for a specified timeout period. Whilst one user is active all the other users that are connected to the same computer will see a "video only" message displayed on their screen.

There may be situations where particular users want to be able to control and view their computers in private with exclusive use. The LINDY Dual/Quad PRO has the facility to allow users to select exclusive use of computers but this facility should be used with care. When exclusive use is requested the video from the selected computer is only available to the user with exclusive access. Users that have selected exclusive access are never timed out by the LINDY Dual/Quad PRO and so all other users are effectively "locked out" until the exclusive user switches to another computer or logs out. This could potentially be very irritating if a user has selected exclusive use and has then left their desk without logging out. This would prevent other users from working on the computer until they came back.

Consequently the system administrator can disable all exclusive use so that all connections are shared.

3.6.6 AUTOMATIC LOGOUT

Accessed from menu: SETUP OPTIONS

Settings: DISABLED, ENABLED

The CPU Switch enables you to restrict access to your computers on a login basis. If a user forgets to logout when they have finished accessing the CPU Switch then the user console may unintentionally be left with full access to all the computers. The CPU Switch may be set to automatically logout unattended user consoles when the screen saver kicks in. This reduces the risk of security problems by preventing user consoles remaining in a permanent "logged-in" state when there is no keyboard or mouse activity. The automatic logout feature is only enabled when the screen saver feature is active (i.e. not disabled).

3.6.7 MOUSE SWITCHING

Accessed from menu: GLOBAL PREFERENCES

Settings: ENABLED, DISABLED

Like most LINDY Electronics Ltd KVM switches, the LINDY Dual/Quad PRO channel may be switched using a three button mouse or IntelliMouse (see section 4.9).

Pressing the central button or wheel button together with the left hand mouse button will cause the LINDY Dual/Quad PRO to switch to the next available computer.

When mouse switching is enabled the central mouse button or wheel mouse button is allocated to control the LINDY Dual/Quad PRO and is not therefore available for use by computer applications. If you want to use the central mouse button within your applications you will need to disable mouse switching. The rotation action of an IntelliMouse wheel is not affected and is always available to the PC application.

3.6.8 SCREEN SAVER

Accessed from menu: GLOBAL PREFERENCES

Settings: DISABLED; 2, 5, 7, 10,15, 20 & 30 MINUTES

To avoid burning out the phosphor on CRT monitor screens, the LINDY Dual/Quad PRO can be set to blank the screen after no keyboard or mouse activity has been detected for a selected timeout period. If preferred, the user can blank the screen manually by selecting channel '0' using the keyboard hotkeys or by pressing ESC from the login screen.

3.6.9 AUTOSCAN MODE

Accessed from menu: GLOBAL PREFERENCES

Settings: ACTIVE, ALL

The LINDY Dual/Quad PRO supports an autoscan mode that automatically scans between the connected computers in sequence. The LINDY Dual/Quad PRO can be set to scan ALL the available computers or just the available computers that are currently powered on (the ACTIVE computers). Scanning just the active computers avoids blank screens from being displayed and stops the monitor from going into a power down state on every scan cycle.

WARNING - Many modern monitors are fitted with automatic power save relays and will switch off after a few seconds if connected to an inactive PC. If you are using such a monitor you must not set the LINDY Dual/Quad PRO to scan ALL ports. Constant switching on and off of your monitor's relay will eventually damage your monitor.

3.6.10 AUTOSCAN TIME

Accessed from menu: GLOBAL PREFERENCES

Settings: DISABLED; 2, 5, 7, 10, 15, 20, 30 SECONDS

The autoscan time defines the length of time that the LINDY Dual/Quad PRO will display video from an autoscanned computer before changing to the next computer. If the DISABLED setting is chosen then no autoscan functions will be available.

3.6.11 OSD DWELL TIME

Accessed from menu: GLOBAL PREFERENCES

Settings: 1, 2, 3, 5, 10 SECONDS

After a successful computer channel change the LINDY Dual/Quad PRO will display a confirmation message for a few seconds. The length of time that this confirmation message dwells on the screen may be changed. Options are 1, 2, 3, 5 and 10 seconds.

3.6.12 USER TIMEOUT

Accessed from menu: GLOBAL PREFERENCES

Settings: 2, 5, 10, 30 SECONDS; 1, 5, 10 MINUTES

When two users are connected to the same computer only one can have access at any one time. When no keyboard or mouse data has been received from the active user port for the user timeout period the LINDY Dual/Quad PRO will allow other users to access the computer. The new port then becomes the active port until it too times out. To avoid confusion between users it is desirable to set the timeout period to be sufficiently long so that user's work is not needlessly interrupted by other users and sufficiently short to ensure good overall system efficiency. The user timeout value also controls the timeout between the local and remote access points on user ports 1 and 3.

3.6.13 RS232 Mouse Type

Accessed from menu: GLOBAL PREFERENCES

Settings: INTELLIMOUSE, 2 BUTTON, 3 BUTTON

These setting control the type of RS232 mouse that the LINDY Dual/Quad PRO reports to computers. All the necessary conversions are dealt with automatically with the LINDY Dual/Quad PRO. The IntelliMouse setting sends four byte mouse reports to the computers and is therefore very slightly more sluggish than the others that send three byte mouse reports. RS232 mice are almost always more sluggish than PS/2 types because the data rate is much slower.

4. Using the LINDY Dual/Quad PRO

This section explains the general operation of the LINDY Dual/Quad PRO. We recommend that you read this section before starting to use the product.

4.1 Rear panel special function switches

Before powering on the LINDY Dual/Quad PRO ensure that the two option switches on the rear are set to the OFF (up) position. Option switch 1 is reserved for future use and option switch 2 is used to enable firmware upgrades (see section 5).

4.2 Power supply connections and indicators

The LINDY Dual/Quad PRO is fitted with two power inlets that are labelled A and B (see figure 2). These power inlets are both the same and either inlet may be used to power the LINDY Dual/Quad PRO. The LINDY Dual/Quad PRO is shipped with a single power adapter but you may optionally purchase a second power adapter to provide power supply redundancy (part code PSU-IEC-5VDC). Plug the power adapter into one of the inlets. The power indicators on the front of the LINDY Dual/Quad PRO (see figure 1) monitor the voltage that is being supplied to each power inlet. If the power indicators A or B are illuminated then a healthy power adapter is connected. If you have two healthy power adapters connected then you may disconnect and reconnect one of them without disturbing the operation of the LINDY Dual/Quad PRO.

4.3 USER display and key switch

The USER key selects the user port that is shown on the green USER display (see figure 1). Pressing the key will cause the green display to change to the next user port in numerical sequence. When the USER display is changed, the red COMPUTER display will also change to show the current connection status of the new user port. LINDY Dual/Quad PRO 4 models have 4 user ports and LINDY Dual/Quad PRO 2 models have 2 user ports.

4.4 COMPUTER display and key switch

The COMPUTER key selects the computer port that is to be connected to the user port that is currently displayed on the green USER display (see figure 1). Pressing the key will cause the red COMPUTER display to change to the next available computer port in numerical sequence. The next available computer port is defined by the way that the LINDY Dual/Quad PRO is configured.

There are two special computer ports that may be selected using the COMPUTER key switch. These are the on-screen menu port 'o' and the non-existent channel zero '0'. Selecting the on-screen menu port will cause the on-screen menu or the login menu to be displayed. Selecting channel zero will cause the video to be disabled and all keyboard and mouse activity to have no effect upon any of the connected computers. These channels are provided as convenient places to 'park' user ports that are not currently in operation.

Lindy CPU Switch Dual Pro models have a single digit COMPUTER display

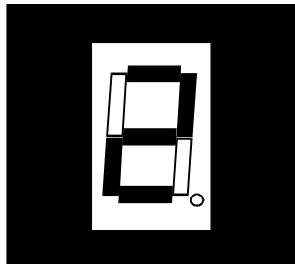

Lindy CPU Switch Quad Pro models have a dual digit COMPUTER display

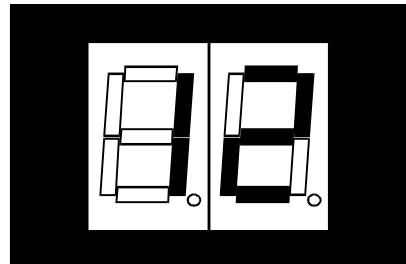

DISPLAY SHOWS

MEANING

Computer number is displayed and is not flashing

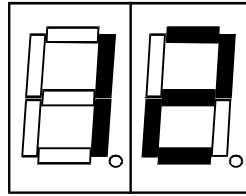

The user port shown on the green USER display is connected to the displayed computer port

Zero (0)

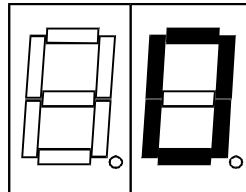

The user port shown on the green USER display is connected to the non-existent channel zero. No video picture is displayed on this user port.

Lower case 'o'

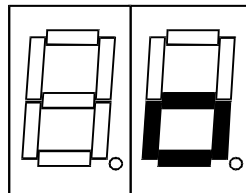

The user port shown on the green USER display is currently showing the on-screen display menu

4.5 Activity indicators

The LINDY Dual/Quad PRO has a front panel activity indicator for each user port (see figure 1). The indicator will flash when keyboard or mouse data is received by the LINDY Dual/Quad PRO. These indicators provide a useful confirmation that the keyboards and mice connected to the LINDY Dual/Quad PRO are functioning normally.

4.6 Selecting a computer using the front panel controls

To select a computer using the front panel controls, press the USER key until the green USER display shows the user port number that your keyboard and mouse are connected to. Then press the COMPUTER key until the red COMPUTER display shows the computer that you wish to connect to. Pressing the computer key will cause the computer channel to change to the next available port. If the password security system has not been enabled then this will be the next highest channel number in the sequence shown below. If password security has been enabled then you will only be able to select the computer ports that you have access to. If the front panel controls have been disabled by the administrator then you will only be able to select the special channels 'o' and '0' (the on-screen menu / login screen or non-existent channel zero).

Action of the COMPUTER key if no security has been set and the front panel controls are enabled

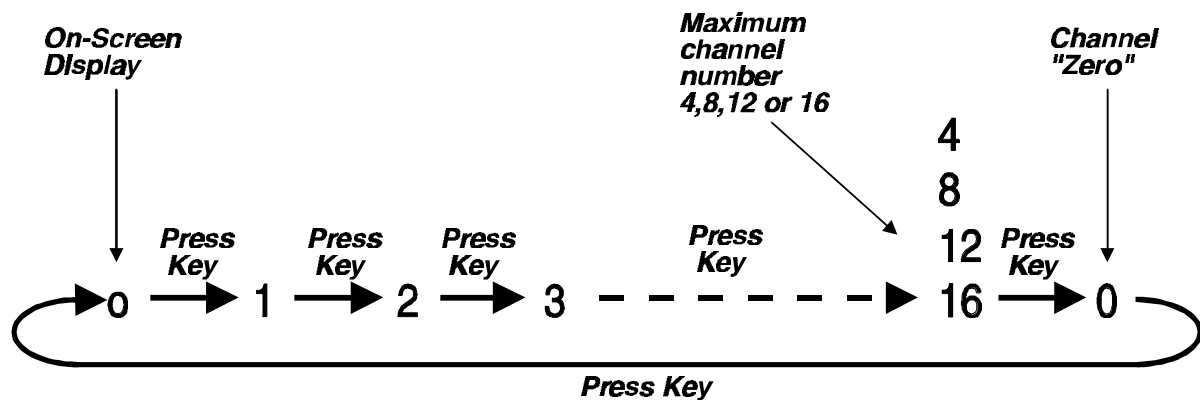

Action of the COMPUTER key if the front panel controls are enabled, security has been set and the current logged in user only has access to computer ports 1, 3 and 7

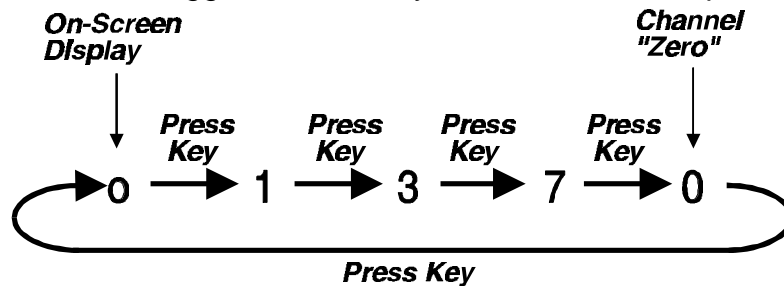

Action of the COMPUTER key if the front panel controls have been disabled.

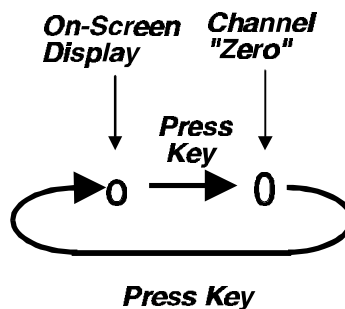

4.7 Logging on to the LINDY Dual/Quad PRO

If password security has been set on the system then the following login menu will appear when the LINDY Dual/Quad PRO is switched on or when no user is currently logged in. The previous user may have activated the screen save function (screen blanking). If so, you may need to press a key before the login menu appears. Type in your user name and password to access the LINDY Dual/Quad PRO.

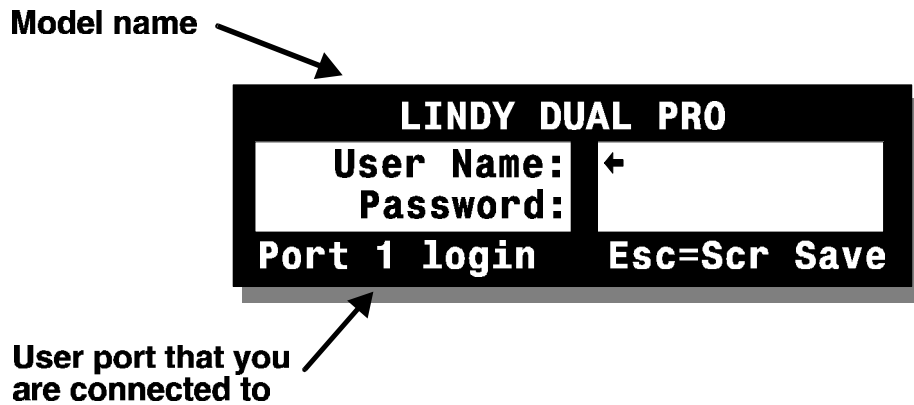

4.8 Keyboard hotkeys

LINDY Dual/Quad PRO can be conveniently controlled using special keyboard hotkey combinations. These hotkey combinations can be used to select computers and perform a number of other useful functions. All of the hotkey control commands are invoked by holding down the hotkeys and then pressing a command key. By default, the two hotkeys are 'CTRL' and 'ALT', although other combinations can be selected by reconfiguring the hotkeys (see section 3.6.3). Once the hotkey command has been activated you will need to release the hotkeys and the command key before a new hotkey command is accepted by the LINDY Dual/Quad PRO. HOTKEYS + TAB is an exception and this allows you to 'tab through' the ports by holding down the hotkeys and repeatedly pressing TAB. HOTKEYS + the cursor keys is also an exception. You can hold down the hotkeys and repeatedly press the cursor keys to change the position of the on-screen menu.

The hotkey commands are summarised below (note that the numbers on the numeric keypad do not form part of a valid hotkey). The hotkeys will only select the requested channels if you have access rights to the requested channel.

Selecting computers using the hotkeys and the port number is most suitable for systems with small numbers of computers. For systems with more computers it is easier to use the on-screen menu for computer selection.

'HOTKEYs' and '1' - selects channel 1	
'HOTKEYs' and '2' - selects channel 2	
'HOTKEYs' and '3' - selects channel 3	
'HOTKEYs' and '4' - selects channel 4	
'HOTKEYs' and '5' - selects channel 5	(8,12 & 16 port models only)
'HOTKEYs' and '6' - selects channel 6	(8,12 & 16 port models only)
'HOTKEYs' and '7' - selects channel 7	(8,12 & 16 port models only)
'HOTKEYs' and '8' - selects channel 8	(8,12 & 16 port models only)
'HOTKEYs' and '9' - selects channel 9	(12 & 16 port models only)
'HOTKEYs' and '1 then 0' - selects channel 10	(12 & 16 port models only)
'HOTKEYs' and '1 then 1' - selects channel 11	(12 & 16 port models only)
'HOTKEYs' and '1 then 2' - selects channel 12	(12 & 16 port models only)
'HOTKEYs' and '1 then 3' - selects channel 13	(16 port models only)
'HOTKEYs' and '1 then 4' - selects channel 14	(16 port models only)
'HOTKEYs' and '1 then 5' - selects channel 15	(16 port models only)
'HOTKEYs' and '1 then 6' - selects channel 16	(16 port models only)

'HOTKEYs' and 'TAB' - selects the next available channel

'HOTKEYs' and 'M' - displays the on-screen menu for selecting computers by name (this is the recommended way of selecting computers for systems with more than 4 computers)

'HOTKEYs' and 'A' - selects autoscan mode where each channel is displayed for the selected time (see section 3.6.10). To cancel autoscan mode simply select any fixed channel either by hotkey or by using the on-screen menu or the front panel controls.

'HOTKEYs' and '0' – switches off the video signal. This will cause some monitors to go into standby mode or switch off. The video signal can be re-enabled by selecting a channel.

'HOTKEYs' and 'L' - Logs out the user if password security has been enabled or disables the video and selects the non-existent channel '0' if no security is set.

'HOTKEYs' and 'the cursor keys' - Moves the currently displayed on-screen menu around the screen.

'HOTKEYs' and '0 then {number}' – (where {number} is 0,1,2,3,4,5,6,7,8 or 9).

Selects the channel specified by {number}. This allows ports on cascaded units to be selected. For example HOTKEYS + 0 10216 would select port 1 (01) on the current LINDY Dual/Quad PRO, port 2 (02) on the next cascaded LINDY Dual/Quad PRO and port 16 on the last LINDY Dual/Quad PRO.

Examples of common hotkey sequences (assuming CTRL + ALT hotkey option):

To select channel 2:

press    release   

To 'tab through' channels:

press    release  press 
release  press  release   

To select channel 12 (on a 12 or 16 port LINDY Quad PRO):

press    release 
press  release   

4.9 Selecting computers using the mouse

Computers may conveniently be selected using a three button mouse. In order to switch to the next computer simply hold down the central mouse button (the wheel mouse button on an IntelliMouse) and click on the left hand mouse button to select the next computer. If password security has been set then the LINDY Dual/Quad PRO will select the next available channel, otherwise it will select the next numerical channel. Mouse switching may be enabled or disabled (see section 3.6.7). When mouse switching is disabled the third button or wheel button state is 'passed through' the LINDY Dual/Quad PRO and seen by the application software.

Selecting computers using the mouse is most suitable for systems with small numbers of computers. For systems with more computers it is easier to use the on-screen menu for computer selection.

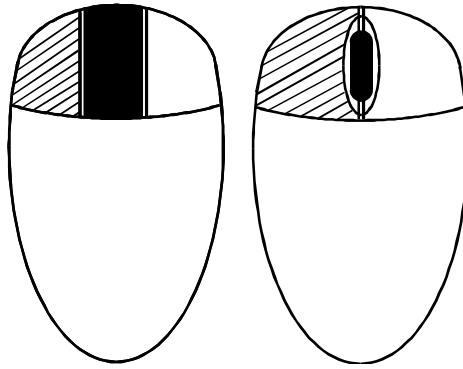

Hold down centre button ()

Press and release left hand button () to select next computer

4.10 Selecting computers using the on-screen menu



You can conveniently select computers by name using the LINDY Dual/Quad PRO's on-screen menu. For systems with many computers this is the recommended method of computer selection. The on-screen menu is called up by pressing the 'HOTKEYS' and the 'M' key together. Its position on the screen may be moved using the 'HOTKEYS' and the cursor keys (see section 4.8)

For example, with the default hotkeys (CTRL + ALT) the key combination to launch the on-screen menu would be:

press    release   

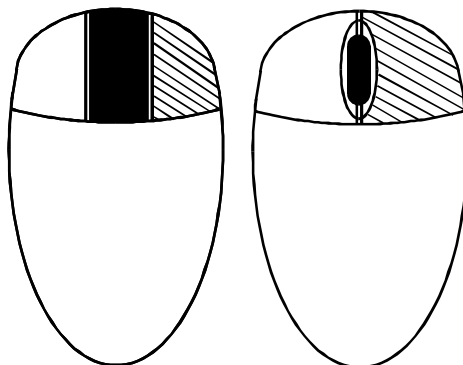
You may also use a 3-button mouse or wheel mouse to launch the on-screen menu if you have enabled mouse control (see section 3.6.7). To do this, hold down the central button or wheel button and click the right hand button.



Hold down centre button (). Press and release left hand button () to launch the on-screen menu

When the menu is first called up, a set of default names will be listed. You will probably want to change these names to suit your computers (see section 3.5). When you launch the on-screen menu you will see a screen similar to that shown below.

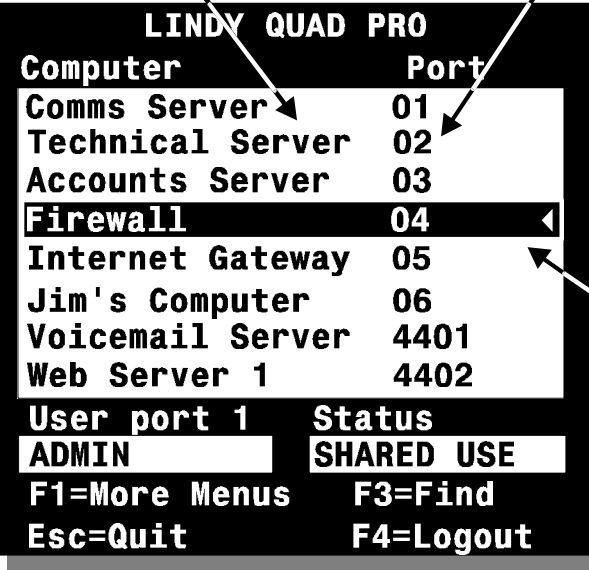

Descriptive computer names (defined by administrator)

Port location for the computer

Indicator shows currently selected computer
 ◀ = shared access
 * = exclusive access
 O = video only

List of available computers. Use the cursor keys and the page up/down keys to scroll up and down the list

lindy CPU Switch Dual / Quad Pro user port

User login name

Menu bar

Connection status: Not connected, connected or exclusive

LINDY QUAD PRO	
Computer	Port
Comms Server	01
Technical Server	02
Accounts Server	03
Firewall	04
Internet Gateway	05
Jim's Computer	06
Voicemail Server	4401
Web Server 1	4402

User port 1 Status
 ADMIN SHARED USE

F1=More Menus F3=Find
Esc=Quit F4=Logout

To connect to a computer, place the menu bar over the computer name using a combination of the up and down cursor keys and the page up / page down keys.

You may also use the wheel on a wheel mouse to move the menu bar up and down. If you have enabled mouse control (see section 3.6.7).

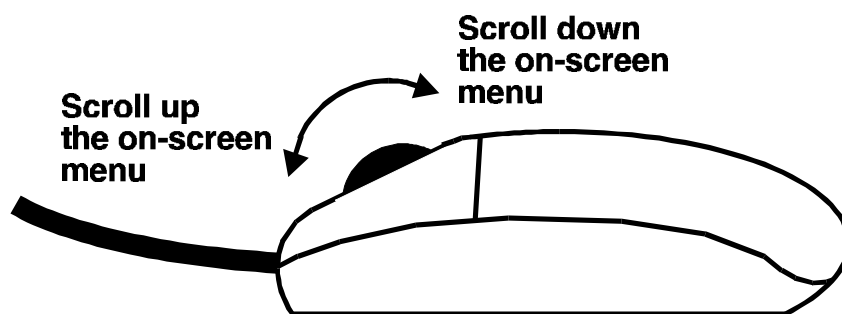

To select the computer with **SHARED** access press:

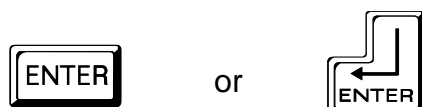

When a computer is selected in SHARED mode, the computer's video picture will be displayed on all the KVM consoles that are connected to that computer. Only one user will have control of the computer's keyboard and mouse at any one time. If no keyboard or mouse activity has been detected for the timeout period (see section 3.6.12) then other KVM consoles may gain control.

To select the computer with **EXCLUSIVE** access press:

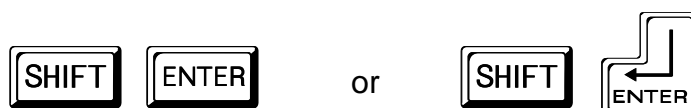

When a computer is selected in EXCLUSIVE mode, the computer's video picture will only be displayed on the KVM console that has exclusive access. Other KVM consoles will not be able to access the computer or view its video until the exclusive user has selected another computer or logged out. This mode prevents other KVM consoles from using the computer and so should be used with care.

To select the computer with **VIDEO ONLY** access press:

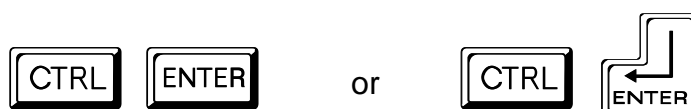

When a computer is selected in VIDEO ONLY mode, the computer's video picture will be displayed on the KVM console's monitor but they keyboard and mouse will not control the computer. The "VIDEO ONLY" message will be displayed under the confirmation banner if this has been enabled.

To select the computer with shared access press:

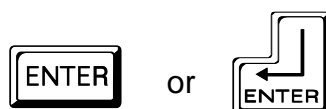

You may also use a 3-button mouse or wheel mouse to select a computer if you have enabled mouse control (see section 3.6.7).

To select a computer in **SHARED** mode use the left hand mouse button () whilst the menu bar is positioned above the required computer name. To escape without selecting a new computer use the right hand mouse button.

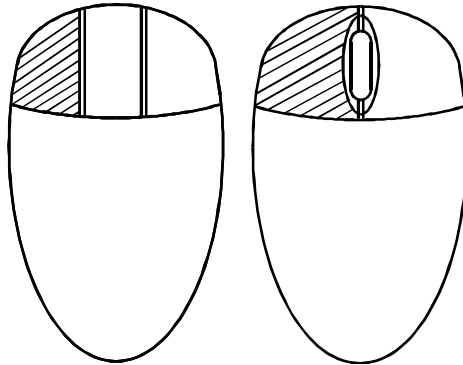

To select a computer in **EXCLUSIVE** mode, use the left hand mouse button together with the SHIFT key on the keyboard. To select a computer in **VIDEO ONLY** mode use the left hand mouse button together with the CTRL key on the keyboard.

If you have many connected computers then you can do an alphabetic search of the list of computer names by pressing F3 and then entering the name that you want to find.

When you select a computer the LINDY Dual/Quad PRO will briefly confirm the computer that has been selected by displaying a message. There may be situations where the selected computer cannot be accessed and in this case the LINDY Dual/Quad PRO will display an error message and wait for the user to press ESC before continuing. The LINDY Dual/Quad PRO may not be able to connect due to the following reasons:

- The requested port is being accessed exclusively by another user.
- There are no free cascade links available.
- The requested port does not exist.

LINDY Dual/Quad PRO confirms a successful connection

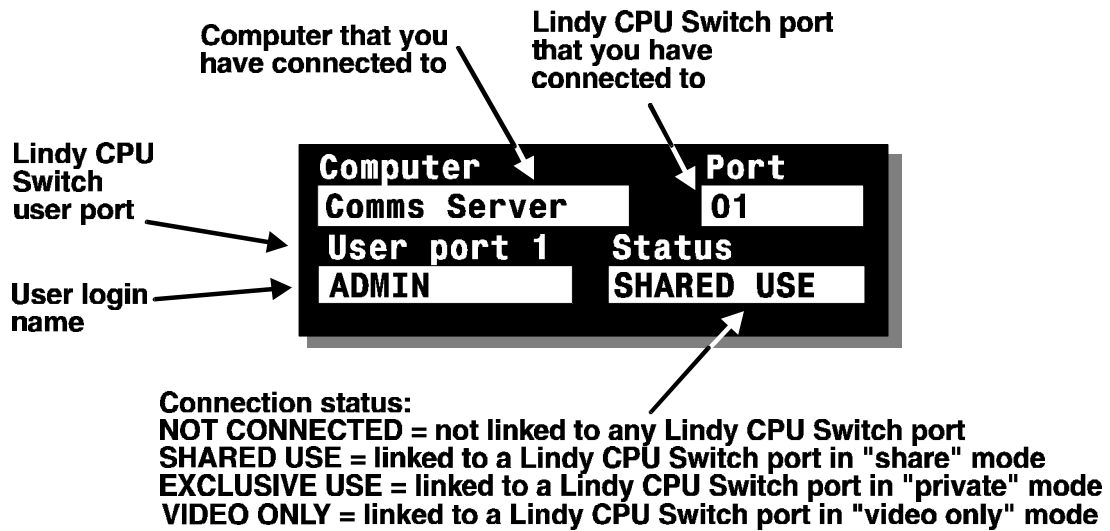

LINDY Dual/Quad PRO indicates an unsuccessful connection



4.11 The reminder banner

Normally the LINDY Dual/Quad PRO will display a discreet computer name reminder banner that reminds you which computer you are connected to. This banner will normally appear at the top of the screen in a central location and may optionally be disabled (see section 4.12.2). Many computer screens can look very similar and so this banner serves as a useful reminder of which computer you are working on. The colour and transparency of the banner can be selected to make it as discreet as possible. It may also be moved around the screen in any direction by using the 'HOTKEYS' together with the cursor keys.

For example to move the banner up the screen (assuming the default CTRL + ALT hotkeys) use:



The computer name banner is also used to tell you that another user is using the computer that you are currently connected to. Whilst the other user has control of the computer you will see the message "Video Only" below the computer name banner.

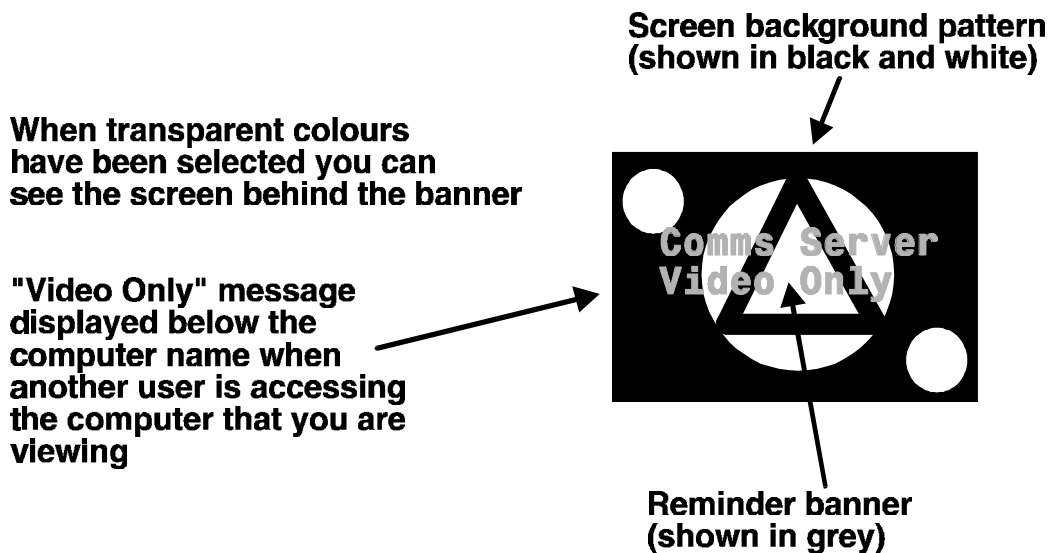

4.12 Setting the USER PREFERENCES

The **USER PREFERENCES** are system operating parameters that are independently selectable for each user. From the main menu press **F1** for **MORE MENUS**. Use the cursor keys to position the menu bar over **USER PREFERENCES**. Press **ENTER** or **RETURN** to view the preferences. Use the cursor keys to place the menu bar over the required option and then use **SPACE BAR** to change the option as required. Press **ESC** to quit and save the changes.

4.12.1 OSD COLOUR

Accessed from menu: **USER PREFERENCES**

Settings: **DEFAULT**, **SCHEME 1**, **SCHEME 2**

As you toggle between these options you will see the colour of the menu change to show the selected scheme. The menu schemes have been specially chosen to provide a high contrast with the colours that you would normally see on a computer screen.

4.12.2 REMINDER BANNER

Accessed from menu: **USER PREFERENCES**

Settings: **ENABLED**, **DISABLED**

When the reminder banner is enabled, the name of the currently selected computer will appear in a small reminder banner. This is normally located at the top of the screen in a central position but may be moved as required (see section 4.8)

4.12.3 REMINDER COLOUR

Accessed from menu: USER PREFERENCES

Settings: BLUE/TRANS, PINK/TRANS, BLUE/WHITE, WHITE/RED

You may select the colour of the reminder banner. The BLUE/TRANS and PINK/TRANS select blue or pink text with a transparent background. The BLUE/WHITE and WHITE/RED settings select blue and white text on solid white and red backgrounds.

4.12.4 SCREEN SAVER TYPE

Accessed from menu: USER PREFERENCES

Settings: BLANK, MOVING DOT

You may select the type of screen saver. If you select BLANK then the screen will blank completely. If you select MOVING DOT then a moving dot will be displayed on a blank background. The dot regularly changes colour and bounces off the sides of the screen in a zigzag pattern.

4.13 Using the FUNCTIONS menu

The FUNCTIONS menu provides you with a number of useful functions that will help you to make the most of your LINDY Dual/Quad PRO. You can access the FUNCTIONS menu from the main on-screen menu by pressing F1 and selecting FUNCTIONS.

Standard users will be offered just two functions:

RESTORE STANDARD MOUSE and
RESTORE INTELLIMOUSE

If you have disconnected a mouse cable or you have switched the LINDY Dual/Quad PRO off then the mouse connection will normally be lost. To reconstitute the mouse connection use the mouse reset functions. See section 2.9 for a full explanation of how these functions work.

The ADMIN user is also given the option to **RESET TO FACTORY DEFAULTS**. This will clear all the computer and user names and set all parameters back to the

factory defaults. To avoid activating this function by accident the administrator must confirm the reset instruction by pressing F8.

4.14 Querying the routing status

It is sometimes useful to know which KVM consoles are connected to which computers and their connection modes (shared, exclusive or video only). For example, if the CPU Switch denies you access to a particular computer you may wish to know if another KVM console has exclusive use of this computer and consequently is preventing your access. To query the routing status press F1 from the main on-screen menu and then select ROUTING STATUS. A routing status display similar to the one shown below will be displayed for 10 seconds. Press ESC to quit or wait for the routing status screen to disappear.

The screenshot shows a terminal window titled "Routing Status" with the following text:

```
Routing Status
User 1 : ADMIN
Computer : main-file1
Port:2102 SHARED USE
User 2 : NIGEL
Computer : main-firewall1
Port:16 EXCLUSIVE USE
User 3 : JIM
Computer : Comms Server
Port:08 VIDEO ONLY
User 4 : NO USER
Computer :
Port:00 NOT CONNECTED
Esc=Quit
```

Annotations on the left side:

- An arrow points from the text "User 1 is the user attached to port 1 of the LINDY CPU Switch" to the first user entry.
- An arrow points from the text "Dual models will show no user for ports 3 and 4 because they are not fitted" to the fourth user entry.

Annotations on the right side:

- An arrow points from the text "Name of user" to the "ADMIN" value.
- An arrow points from the text "Name of computer" to the "main-file1" value.
- An arrow points from the text "Type of access" to the "SHARED USE" value.

4.15 Using the dual access ports (1 and 3)

The LINDY Dual/Quad PRO 2 is fitted with one dual access port and the LINDY Dual/Quad PRO 4 is fitted with two dual access ports. These dual access ports have connectors that enable a local KVM (Keyboard, Video monitor and Mouse) to be attached and a connector that enables a remote LINDY Extender or LINDY Pro Extender to be attached. Either the local KVM, connected directly to the LINDY Dual/Quad PRO, or the remote KVM, connected to the LINDY extender, may be used to access the LINDY Dual/Quad PRO. The video picture is duplicated on both the local and remote access points but the LINDY Dual/Quad PRO will accept keyboard and mouse data from only one KVM at a time. Whilst one of the KVM's is active, the num, caps and scroll lock keys on the inactive KVM's keyboard will flash indicating that the KVM does not have control.

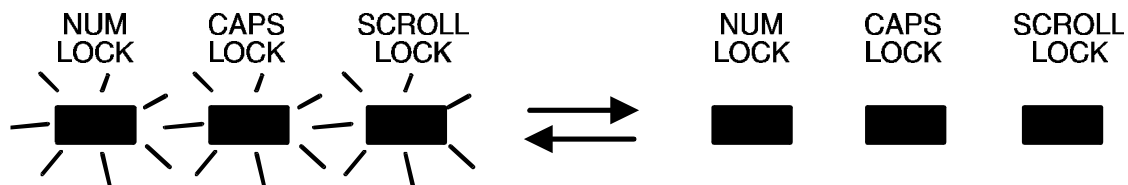

Once there has been no keyboard or mouse data from the active KVM for the timeout period (see section 3.6.12 for instructions on how to set the timeout period), the other KVM is allowed access. Once keyboard or mouse data activity is detected from this new KVM it gains control and the other KVM is disabled.

4.16 Cascading LINDY Dual/Quad PRO's

LINDY Dual/Quad PRO s can be cascaded in a tree structure to support larger numbers of computers. Up to four cascade levels are supported and the number of cascade links between LINDY Dual/Quad PRO's can be chosen by the user. The number of installed cascade links determines the number of users that may be accessing ports on the cascaded units simultaneously. The full rules that must be followed when configuring a cascade of LINDY Dual/Quad PRO's are given in section 2.5.

Although it is theoretically possible to select computers on cascaded units by pressing the hotkeys and then typing in the port address this would be highly confusing for users and is not generally recommended. Consequently it is normally advisable to use the on-screen menu to select computers on cascaded units.

However it is sometimes useful to be able to connect to ports on cascaded units via a specific cascade cable (rather than the first available of a group) in order to check that the cabling is working as expected. To do this you can use a hotkey sequence similar to the example shown below.

For example to connect to port 14 on a LINDY Dual/Quad PRO 4 that is cascaded off port 1 of your first LINDY Dual/Quad PRO . Although the following example selects a port with a four digit address (port 0114) you can type port addresses that are eight digits long to access computers that are on the forth cascade level (e.g. Port 01140203).

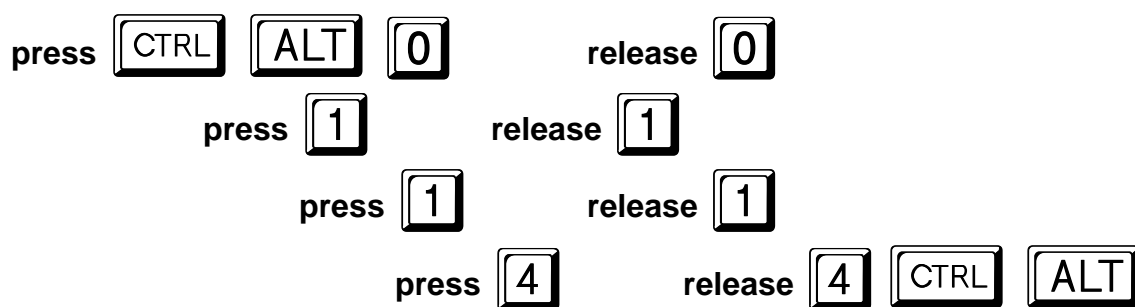

4.17 Resetting user port keyboards and mice

The LINDY Dual/Quad PRO gives you the facility to perform a complete power off reset of the keyboard and mouse that are connected to a selected user port. This can be useful if you wish to disconnect the keyboard or mouse and replace them with alternatives. Keyboards will enable themselves automatically if they are disconnected and then re-connected to the LINDY Dual/Quad PRO. Mice will not normally re-enable themselves after they have been disconnected and re-connected although they will do so automatically if the LINDY Dual/Quad PRO's channel has been changed whilst the mouse is disconnected.

Consequently you will normally need to perform a power-off reset of the user port if you have disconnected and re-connected a mouse. The power off reset function only affects the selected user port and does not affect any of the computer connections or any of the other user ports.

To perform a power-off reset for a selected user port:

- 1) Press the USER key on the front panel of the LINDY Dual/Quad PRO to select the user port whose keyboard and mouse you wish to reset.
- 2) The selected user port number should now be shown on the green USER display.
- 3) Press and hold down the USER key for 5 seconds until the green USER display goes off. The keyboard and mouse will then be powered off.
- 4) As soon as the green display goes off you may release the USER key. The green display will then come back on and a few seconds later the keyboard and mouse will be powered on and ready for use.

4.18 Using the LINDY Junior / Pro Extender

Refer to the installation guide provided with your LINDY Extender. The transmitter unit (LINDY Extender) is built into the LINDY Dual/Quad PRO so you will only need the receiver (LINDY Junior Extender unit). You may use a LINDY Junior Extender receiver or a LINDY Pro Extender receiver.

When using an LINDY extender we highly recommend that you set the LINDY hotkeys to be different to the LINDY Dual/Quad PRO's hotkeys to avoid any confusion

4.19 What to do if you forget your ADMIN password

If you forget your ADMIN account password you will not be able to access the LINDY Dual/Quad PRO to add or edit users and computer names. If this unfortunate situation does occur then you can resolve it by performing a complete reset to return the LINDY Dual/Quad PRO to its factory default state. A complete reset erases all the user names and computer names that you have setup. You can only perform a complete reset if you have access to both the front and the rear of the LINDY Dual/Quad PRO.

To perform a complete reset and return the LINDY Dual/Quad PRO to its factory default state:

- 1) Power on the LINDY Dual/Quad PRO normally.
- 2) Whilst the LINDY Dual/Quad PRO is powered on move switch 2 on the rear panel of the LINDY Dual/Quad PRO (labelled UPGRADE) to the ON (down) position.
- 3) Press the USER and the COMPUTER keys together.
- 4) The green USER display will show 'r' for a few seconds to confirm that a reset is taking place.
- 5) Return switch 2 to the normal OFF position (up).

4.20 Saving and restoring the menu configuration to and from an Excel compatible file.

The CPU Switch will store up to 512 computer names and 16 sets of user access rights. If you have a cascade of CPU Switches then it may take some time to enter all the computer names and port numbers and decide on the access rights that you are going to grant to each user profile. Consequently, for peace of mind it is useful to be able to store these settings. This can be done by connecting a computer to the CPU Switch's RS232 serial port and uploading to configuration settings. **You can only perform this function if you are logged onto the CPU Switch as the ADMIN user.** The file that is used to store the configuration settings has the additional advantage that it can be loaded into an Excel spreadsheet and edited to make changes to computer names and access rights. This edited information may then be downloaded back to the CPU Switch.

To save the menu names and configuration settings:

1. Logon to the Lindy website at www.lindy.com and download the files DQPREAD.EXE and DQPWRITE.EXE.
2. Connect the serial port on the rear of the CPU Switch to a serial COM port on your computer using the serial cable supplied with the CPU Switch. If you have lost this cable then you may use a replacement cable with a 9-way female connector on one end and a 9-way male connector on the other end and all lines connected straight through (i.e. pin 1 to pin 1, 2 to 2, 3 to 3 etc.).

3. Run the program DQPPREAD.EXE on the computer that is connected to the CPU Switch's serial port. Follow the instructions given by the program.
4. Make sure that you are logged onto the CPU Switch as the ADMIN user. From the main selection screen press F1 for **More Menus**. In the **Configuration Menu** select **Functions**. In the **Functions** menu select **Send Data to RS232 port**.
5. The CPU Switch should then send the configuration data to your computer. The DQPREAD program will store the data in a file named DQPDATA.CSV that will be created in the same directory that you ran the DQPREAD program from. Please ensure that you have sufficient rights to write to this directory.

To edit the menu names and configuration settings:

You may open the DQPDATA.CSV using a spreadsheet program such as Microsoft Excel. The format of a typical file is shown below. You will see that the computer names (rows) are tabulated against the user profiles (columns). To grant a user access to a computer, enter the value 1 in the box that is common to the computer's row and the user's column. To deny access, leave this box blank. To add extra users, add additional columns (up to 16 users). To add extra computers, add additional rows (up to 512 computers). The ADMIN user will always be granted access to all computers regardless of the values entered.

USERS		ADMIN	Alan	Jim	Sue	Test
PASSWORDS		password	letmein	hello	logmein	Test
COMPUTERS	PORT					
Admin PC	2103	1	1	1	1	
Alan's System	2102	1	1	1		
Comms Server	3	1		1		
Comms PC	4	1	1	1	1	
Gateway 1	8	1				
Gateway 2	5	1				
Test System	15	1	1			
Web Browser	9	1			1	1

To restore the saved / edited menu and configuration settings:

1. Connect the serial port on the rear of the CPU Switch to a serial COM port on your computer using the serial cable supplied with the CPU Switch.

2. Copy the program DQPWRITE and DQPDATA.CSV into the same directory on the PC that is connected to the CPU Switch's serial port.
3. Run the program DQPWRITE.EXE and follow the instructions given by the program.
4. Make sure that you are logged onto the CPU Switch as the ADMIN user. From the main selection screen press F1 for **More Menus**. In the **Configuration Menu** select **Functions**. In the **Functions** menu select **Read Data from RS232 port**.
5. The CPU Switch should then receive the configuration data to your computer and load the new menu names and access rights into the menu.

5. Upgrading the LINDY Dual/Quad PRO's firmware

The LINDY Dual/Quad PRO uses flash memory technology which enables the firmware code to be upgraded by the user. New keyboards, mice operating systems and drivers are being launched all the time. From time to time the LINDY Dual/Quad PRO's firmware will be updated to provide support for these new devices. You can take advantage of these upgrades free of charge during the warranty period.

Upgrades are performed by connecting a PC's serial port to the LINDY Dual/Quad PRO's serial port and running an upgrade program on the PC. This upgrade program downloads the new firmware to the LINDY Dual/Quad PRO and checks that the data has been programmed correctly.

You can check the version of the firmware that is currently loaded into your LINDY Dual/Quad PRO using the on-screen menu. To do this activate the on-screen menu using the keyboard hotkeys (see section 4.10) and then press F1. The version number of the current firmware will then be displayed at the bottom of the Configuration Menu.

To perform a firmware upgrade on your LINDY Dual/Quad PRO you will need a suitable serial upgrade cable and an IBM PC compatible computer with an RS232 serial port and an operating system that supports DOS. Suitable upgrade cables with 9-pin serial connectors are provided with the LINDY Dual/Quad PRO . If you have lost your cable then you will need to buy a cable with a 9 way D type male connector on one end and a 9 way D type female connector on the other end with all 9 lines connected "straight through" (i.e. pin 1 to pin 1, pin 2 to pin 2, pin 3 to pin 3 etc.). These are standard serial extension cables.

You will also need to obtain the latest version of the LINDY Dual/Quad PRO firmware which is available by request from www.lindy.co.uk. Please ensure that you have your product serial number and model number at hand when requesting an upgrade.

Note: The normal flash upgrade process does not clear the computer names, user names, security passwords or other configuration settings.

To perform a flash upgrade on the LINDY Dual/Quad PRO :

Step 1 - Prepare your computers

Ensure that you have saved any important work on the connected computers. The LINDY Dual/Quad PRO can be upgraded whilst attached to live systems but remember that the mouse connections will probably need to be reconstituted after the upgrade is finished (see sections 4.13 and 2.9). Where possible, mission critical servers should be switched off or disconnected before performing an upgrade.

Step 2 - Connect your computer to the LINDY Dual/Quad PRO

Connect your computer's serial port to the LINDY Dual/Quad PRO 's serial port (see figure 2). You do not need to set the serial baud rate and protocol because the upgrade program will do this for you automatically (for reference, the RS232 baud rate used by the upgrade program is 19200 and the protocol is 8 bits, 1 stopbit and no parity).

Step 3 - Select flash upgrade mode using option switch 2 (labelled UPGRADE)

Move option switch 2 on the back of the LINDY Dual/Quad PRO to the ON position (down).

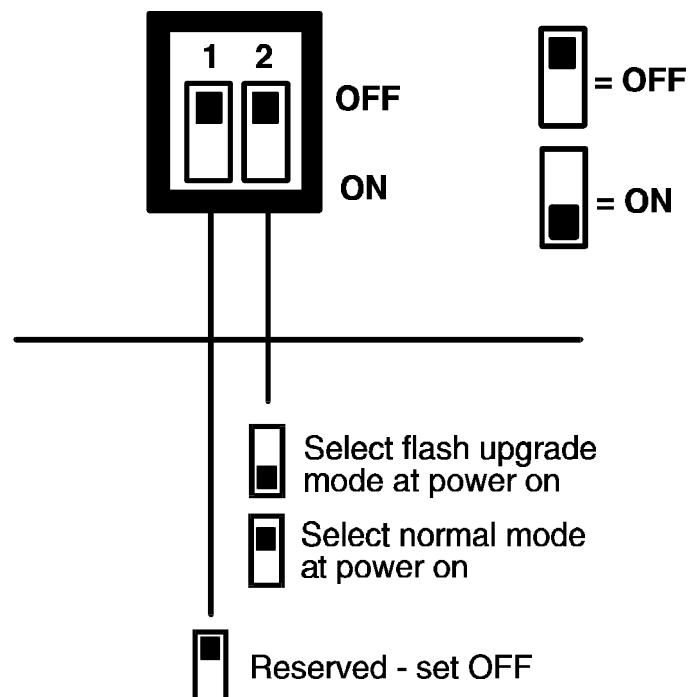

Step 4 - Power off the LINDY Dual/Quad PRO

Remove both power supplies from the Dual / Quad PRO.

Step 5 - Power on the LINDY Dual/Quad PRO with the UPGRADE switch ON

Attach the power adapter to the LINDY Dual/Quad PRO whilst the UPGRADE switch is ON. The green USER display should now show a lower case 'u'. This indicates that the LINDY Dual/Quad PRO is ready to be upgraded.

The display should now show:

**GREEN USER
DISPLAY SHOWS**

Lower case U

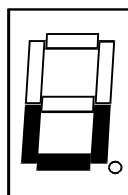

MEANING

Lindy CPU Switch Dual / Quad
Pro is ready to be upgraded

Step 6 - Run the upgrade program

The latest version of the LINDY Dual/Quad PRO firmware is available from the LINDY Electronics Ltd website at www.lindy.co.uk. The upgrade files will be supplied to you as a group and consist of several files as explained below. These files should be downloaded to the same directory on your computer.

- 1) A universal upgrade program

LDQP.EXE

- 2) Binary code files for each of the processors within the LINDY Dual/Quad PRO (up to 3)

e.g. **4X16A129.HEX**
 4X16B129.HEX
 4X16C129.HEX

These files use the following naming scheme. The first four characters are the model type (e.g. 4X16 is a LINDY Dual/Quad PRO 4 with 16 computer ports). The fifth character is the processor designation. The last three characters represent the firmware release version (e.g. 129 equals version 1.29).

A data file that tells the upgrade program (LDQP.EXE) which binary code files (HEX files) to download to the LINDY Dual/Quad PRO and where to put each file.

Theoretically this DAT file can be modified so that only certain processors are upgraded but do not do this unless specifically instructed by LINDY technical support.

e.g. **4X16V129.DAT**

Like the hex files, the first three digits represent the model number (e.g. 2X8 represents a LINDY Dual/Quad PRO 2 with 8 computer ports). The next four digits represent the version number (e.g. V129 equals firmware version 1.29).

To upgrade the LINDY Dual/Quad PRO, check that the DAT file designation matches the model that you have. In other words, if you have a LINDY Dual/Quad PRO 2 with 8 computer ports and you want to upgrade to version 1.30 then the DAT file that you need would be named 2X8V130.DAT. Also check that all the required files are loaded into the same directory on your computer. From that directory run the upgrade file using the following command line.

LDQP {*Dat_file_name*}.DAT

Where **{*Dat_file_name*}** is the name of the required DAT file

For example, if the name of the required DAT file is 4X16V129.DAT then use the following command line:

LDQP 4X16V129.DAT

IMPORTANT NOTE

The upgrade programs are DOS based to enable compatibility with the widest range of operating systems. They run efficiently on DOS, Windows 3.X, Workgroups, 95, 98, ME and Windows NT. The upgrades will take approximately 10 minutes but vary slightly according to the CPU Switch model and the speed of the PC. Upgrades run from PCs using Windows 2000 will take very substantially longer due to the way that this operating system handles the DOS programs. The upgrade will be reliable but may take around 3 hours to complete!

Follow the instructions given on the screen to perform the upgrade. When the upgrade is complete the program will confirm that the upgrade has been successful and then quit.

Step 7 - Switch the UPGRADE key to the OFF position and cycle the power

Switch the UPGRADE switch on the rear of the LINDY Dual/Quad PRO to the OFF position and disconnect the power. When the power is re-applied the LINDY Dual/Quad PRO will operate using the new firmware.

Some useful issues to bear in mind when performing flash upgrades

The upgrade program rewrites the LINDY Dual/Quad PRO's firmware code. If the upgrade process is interrupted then the LINDY Dual/Quad PRO will have invalid code and will not be able to operate. It is therefore good practice to ensure that the upgrade process is always fully completed. A partial or failed upgrade may be rectified by performing another upgrade. If the upgrade process is interrupted accidentally then you should immediately repeat the upgrade process without moving switch 2 from the upgrade (ON) position. Switch 2 forces the LINDY Dual/Quad PRO into flash upgrade mode and prevents the upgraded code from being run. Running faulty or partially upgraded code may have unpredictable results and may damage your LINDY Dual/Quad PRO or computing equipment. For obvious reasons, the code that the LINDY Dual/Quad PRO uses to perform upgrades is not itself upgradable - a common problem on some flash upgradable products that could effectively be destroyed by a partial upgrade!

WARNING - Running faulty or partially upgraded code may have unpredictable results and may damage your LINDY Dual/Quad PRO or computing equipment.

Appendix A. Cable and connector specifications

IMPORTANT NOTE

The maximum cable lengths supported vary widely between devices and cables. It may be possible to use cables that are longer than those specified below with certain PCs and peripherals but this cannot be guaranteed. If you experience problems try using shorter cables.

A1. Keyboard, monitor and mouse to LINDY Dual/Quad PRO

Cable specification:

All of the shared devices plug directly into the relevant ports at the rear of the LINDY Dual/Quad PRO. If you use an AT style keyboard you will need an AT (5 pin DIN female) to PS/2 (6 pin mini-DIN male) converter. Keyboard, monitor and mouse extension cables can be used to increase the distance from LINDY Dual/Quad PRO up to 10m. Most keyboards and mice will also operate at distances of 20 metres.

A2. LINDY to LINDY Dual/Quad PRO

Cable specification:

The LINDY uses standard 4-pair unshielded twisted pair cable of the same type that is commonly used for Ethernet and other networks. Unshielded and shielded types may be used at distances up to 200 metres.

IMPORTANT WARNING

Do not connect the LINDY Dual/Quad PRO's extender ports to an Ethernet hub or other digital network device. The signals carried on the twisted pair cable between the LINDY Dual/Quad PRO and the LINDY are ANALOGUE. Plugging the LINDY Dual/Quad PRO or LINDY into a digital network device such as a hub may damage you devices

A3. LINDY Dual/Quad PRO to PCs 1 to 16

Cable specifications:

Video - 15 pin high density male D connector to 15 pin high density male D connector wired as a standard VGA PC to monitor cable. There are two types commonly available. The best type of cables which will give excellent quality are constructed with coaxial cable cores. Cheaper 'data' cables are often used, but can degrade video quality if used over longer distances. Avoid using 'data' cables longer than 2 metres unless the video quality is not important. Good quality coaxial video cables may be run at distances up to 30 metres with acceptable video quality. In a cascaded application it is advisable to keep the total cable run from computer to KVM no more than 30 metres.

Keyboard and PS/2 mice - 6 pin mini-DIN male connector to 6 pin mini-DIN male connector with all lines connected straight through (1-1,2-2 etc.). If the PC has a 5-pin DIN AT style keyboard connector you will need a PS/2 to AT keyboard adapter 6-pin mini-DIN female to 5-pin DIN male (readily available). Cables should be no longer than 30 metres.

RS232 serial mice - these require a special converter to connect the RS232 lines present on the LINDY Dual/Quad PRO mouse ports to the RS232 port on a PC.

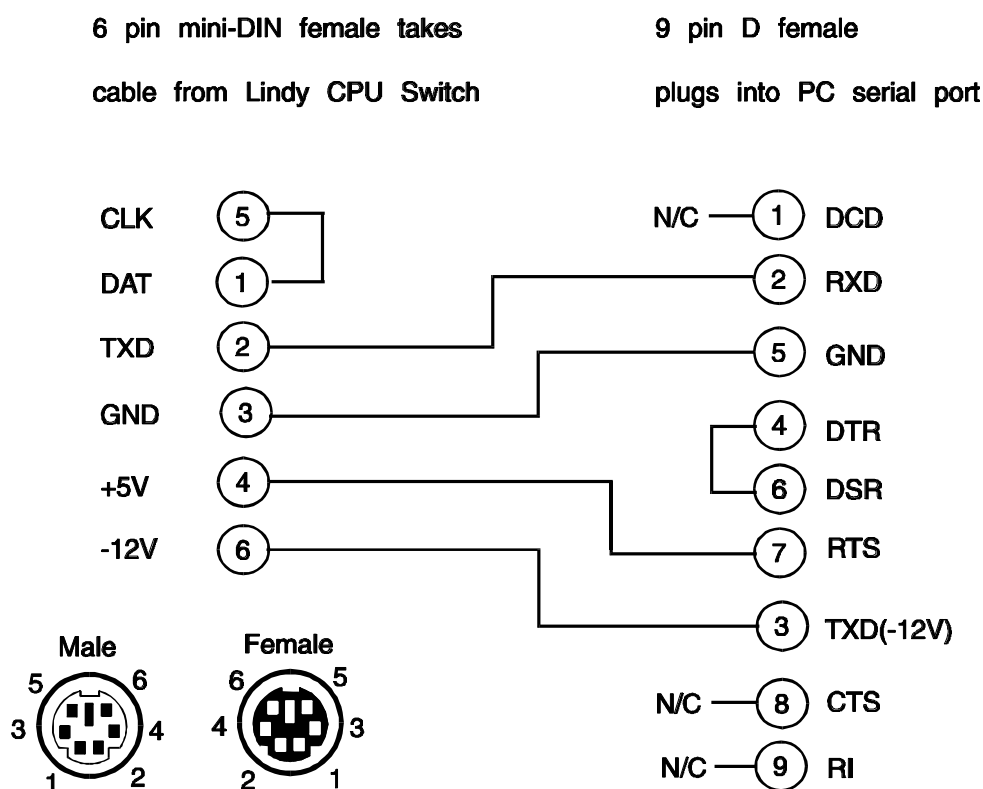

Cables should be no longer than 30 metres.

NOTE - There are several common wiring specifications for 6-pin mini-DIN to 9-pin serial adapters. If you have an adapter that has been supplied with a mouse it may have a completely different internal wiring to that shown above and may not be compatible with the LINDY Extender.

Recommended cables:

3-in-1 keyboard, video and mouse combination cable - For convenience, neatness and high video quality we recommend the LINDY brand 3-in-1 combination cables. These cables are constructed with tri-coax video links to ensure that high video quality is maintained. They also support DDC signalling and are colour coded in PC99 specification colours for your convenience. These match the colours used on the back of your LINDY Dual/Quad PRO and most modern PCs. These cables are available in various different lengths to suit your requirements. They may be purchased with or without the adapters for AT keyboards and RS232 serial mice. Please quote the following part codes when ordering from your supplier.

Part Code	Description
33701	3-in-1 LINDY cable, 1 metre long
33702	3-in-1 LINDY cable, 2 metres long
33703	3-in-1 LINDY cable, 3 metres long
33704	3-in-1 LINDY cable, 5 metres long
33706	3-in-1 LINDY cable, 10 metres long

Appendix B. Problem Solving

Problem:

Poor video quality with smearing fuzziness or ripple.

Action:

Use screened coaxial video cables to connect your devices to the LINDY Dual/Quad PRO.

Notes

Free Manuals Download Website

<http://myh66.com>

<http://usermanuals.us>

<http://www.somanuals.com>

<http://www.4manuals.cc>

<http://www.manual-lib.com>

<http://www.404manual.com>

<http://www.luxmanual.com>

<http://aubethermostatmanual.com>

Golf course search by state

<http://golfingnear.com>

Email search by domain

<http://emailbydomain.com>

Auto manuals search

<http://auto.somanuals.com>

TV manuals search

<http://tv.somanuals.com>