

# 9 CHANNEL MULTIPLEX DIGITAL VIDEO RECORDER

## Instruction Manual

English Version1.0



**MODEL:**  
**DGN209**



[www.lorexcctv.com](http://www.lorexcctv.com)

Copyright © 2006 LOREX Technology Inc.

Under the copyright laws, this documentation may not be copied, photocopied, reproduced, translated, or reduced to any electronic medium or machine-readable form, in whole or part without the prior written consent of Lorex Technologies Inc., except in the manner described in the documentation.

© Copyright 2006

**Lorex Technologies Inc.  
300 Alden Road  
Markham, Ontario  
L3R 4C1 CANADA**

All rights reserved.

<p>THIS DEVICE COMPLIES WITH PART 15 OF THE FCC RULES. OPERATION IS SUBJECT TO THE FOLLOWING TWO CONDITIONS:</p> <ol style="list-style-type: none"><li>1. THIS DEVICE MAY NOT CAUSE HARMFULL INTERFERENCE, AND</li><li>2. THIS DEVICE MUST ACCEPT ANY INTERFERENCE RECEIVED, INCLUDING INTERFERENCE THAT MAY CAUSE UNDESIRE OPERATION.</li></ol>
--

**NOTE:** This equipment has been tested and found to comply with the limits for a Class B digital device, pursuant to part 15 of the FCC Rules. These limits are designed to provide reasonable protection against harmful interference when the equipment is operated in a commercial environment. This equipment generates, uses, and can radiate radio frequency energy and, if not installed and used in accordance with the instruction manual, may cause harmful interference to radio communications. However, there is no guarantee that interference will not occur in a particular installation.

Operation of this equipment in a residential area is likely to cause harmful interference in which case the user will be required to correct the interference at one's own expense.

**CAUTION:** CHANGES OR MODIFICATIONS NOT EXPRESSLY APPROVED BY THE PARTY RESPONSIBLE FOR COMPLIANCE COULD VOID THE USER'S AUTHORITY TO OPERATE THE EQUIPMENT.

## Table of Contents

Important Safety Instructions .....	5
Introduction .....	6
Features .....	6
System Contents .....	7
Getting Started .....	7
Front Panel Controls .....	8
Back Panel Connections .....	10
Accessing the Main Menu .....	11
Main Menu .....	11
Search .....	11
Last Record .....	12
Full List .....	12
Alarm List .....	12
Time Search .....	12
<i>Timer Recording Setup</i> .....	13
Timer .....	13
HDD Overwrite Setup .....	14
Record IPS Setup .....	14
Record Quality Setup .....	14
Alarm REC IPS Setup .....	14
Alarm REC Quality Setup .....	14
Motion Trigger Record .....	15
<i>Camera Channel Setup</i> .....	15
Motion Detection .....	17
System Setup .....	19
Selecting the Audio Input Channel .....	19
Setting the Internal Audible Alarm Buzzer .....	19
Setting the External Audible Alarm Device .....	19
Setting the Motion Audible Alarm feature .....	20
Setting the Alarm Duration .....	20
Setting the Dwell Time .....	20
Setting the Message Latch Feature .....	20
System Time/Date Set up .....	20
Selecting the Date Display Format .....	20
Setting System Time & Date .....	21
Changing the System Password .....	21
Clearing the Hard Drive Data .....	21
Resetting System to Factory Defaults .....	21
Network .....	22
Operation .....	22
On Screen Display (OSD) .....	22
Recording Methods .....	23
Viewing Options: .....	23
Individual Camera Select (1 - 9): .....	23
Multi View Select: .....	23
Picture in Picture (PIP): .....	23
Zoom: .....	23
Video Search .....	24
Playing Back Video .....	24
Hardware Connection from DVR .....	25
Static IP Setting .....	25
STEP 2: STATIC IP SETTING .....	27
Dynamic IP Setting .....	28
STEP 2: DDNS REGISTRATION FOR A DYNAMIC IP ADDRESS .....	28
STEP 5 : IP SETTING .....	33
STEP 6 : Connect Router .....	33
STEP 7 : Connect to the DVR via the Internet .....	34
Software Operation at the Remote Site .....	35
Control Panel and Basic Operation .....	36
Play Back Operation .....	37
Advanced Settings .....	38
Connecting the Video Web Server Via the Internet Explorer Browser .....	40
Key Lock .....	42
Troubleshooting .....	43
Technical Specifications .....	44

Appendix 1: Installing the HDD .....	45
Appendix 2: Connection Diagram to Cameras and Monitor .....	47
Appendix 3: Pin Configurations .....	48
Appendix 4: Rack Mount Installation .....	49
Appendix 5: Recording Times (in Hours).....	50
Appendix 6: Compatible HDD Brands .....	51

## Important Safety Instructions

All the safety and operating instructions should be read before operating this equipment. The improper operation may cause irreparable damage to the appliance.

Lift and place this equipment gently.

Do not expose this equipment to direct sunlight.

Do not use this equipment near water or in contact with water.

Do not spill liquid of any kind on the equipment.

Do not unplug the power connector before turning the power off correctly.

This equipment should be operated using only the power source from standard package.

Unauthorized repair or parts substitutions may result in fire, electric shock or other hazards.

Do not switch the Power On & Off within short period (within 3 seconds).

Do not attempt to service this equipment by yourself. Refer all servicing to qualified service personnel.

This installation should conform to all local codes.

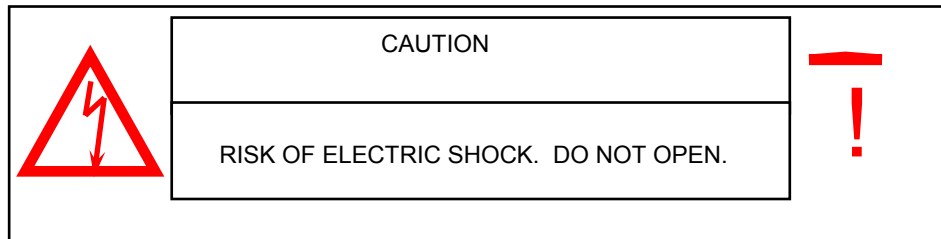

**CAUTION:** TO REDUCE THE RISK OF ELECTRIC SHOCK, DO NOT REMOVE COVER (OR BACK). NO USER-SERVICEABLE PARTS INSIDE. REFER SERVICING TO QUALIFIED SERVICE PERSONNEL.

---

## Introduction

The DXR209 combines a 9 channel multiplexer with a Digital Video Recorder (DVR).

The DVR offers many advantages over traditional time lapse VCR's, allowing you to quickly access and search for a specific time segment or event, which has been recorded. This high quality recorded video can be viewed at various playback speeds as well as frame-by-frame with the Jog Button feature.

To learn more about Lorex products, please visit our website at [www.Lorexcctv.com](http://www.Lorexcctv.com)

## Features

- Wavelet Compression Format
- 4 Audio inputs and 2 outputs
- Resolution: 704X564 - full screen, 352X282 - 4 channels, 224X188 9 - channels
- Independent main and call monitor outputs allow for sequencing of camera views or full screen viewing
- Multi screen display mode
- 9 channel alarm input, alarm display and 1 alarm output
- Video loss detection able to record 160 events on each channel
- Power-loss memory feature (In case of power failure, set-up parameter will remain)
- Supports 1 removable HDD, IDE type (up to a maximum of 250GB)
- Display refresh rate up to 72 IPS (NTSC) and 50 IPS(PAL)
- Record refresh rate up to 25 IPS (NTSC) and 22 IPS (PAL)
- Quick multiple search by date/time, alarm or full list
- Multiple speed playback
- Security password protection
- LAN connector for internet connection

## System Contents

The DXR209 box should include the items listed below. Please take a moment to verify that no items are missing from the package.



DXR209 Digital Video Recorder



80 GB Hard Disk Drive is included



Installation / User Manual



2 Keys for  
Hard Drive Cartridge



Power Adapter and Cord

**NOTE: KEEP THE KEYS IN A SAFE PLACE. THEY ARE NECESSARY FOR INSTALLATION / REMOVAL OF THE HARD DISK DRIVE.**

## Getting Started

If the purchased DVR model did not contain a hard disk drive, please refer to Appendix #1 for HDD installation instructions.

1. Connect video sources and monitor(s) following the configuration example shown in [Appendix # 2](#).
2. Connect the AC Power Cord to the Power Adapter and plug into an electrical outlet. A Red LED indicator light will be ON to indicate that the DVR is in Standby mode.
3. Press the Power button. The POWER LED will turn from red to orange, and other red LED indicators will turn ON. Note: the system takes approximately 5 to 15 seconds to power up. During the power-up, you will see the following messages: "HDD Detecting", followed by "Master HDD Connected".

Once connected, the POWER LED will change to green, and the red indicator lights will be ON next to the Alarm and Timer buttons. (The Alarm and Timer LED's simply indicate that these features are enabled)

**NOTE: IF YOU GET THE MESSAGE "HDD NOT FOUND", PLEASE SEE APPENDIX #1 AS THE HDD IS LIKELY NOT INSTALLED CORRECTLY.**

## Front Panel Controls

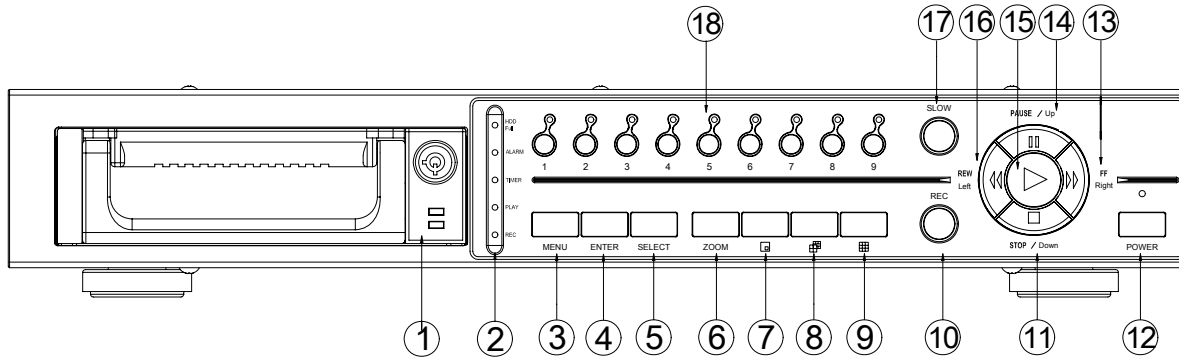

### 1. REMOVABLE HDD CARTRIDGE

Please refer to Appendix #1.

### 2. LED INDICATORS

These LED Lights are ON under the following conditions:

- HDD Full: HDD is full
- ALARM: If you want to turn off the ALARM LED light, please refer to page 13 and set the Camera / ALARM item as OFF (all of the cameras should be set as OFF.)
- TIMER: When Timer is set as Enabled
- PLAY: On Play mode
- REC: On Recording mode

### 3. MENU

Press MENU to enter or exit the system setup menu.

### 4. ENTER

Press ENTER to select an item for change while in the setup menu.

### 5. SELECT

Press the SELECT button to change the camera shown in the individual panes of the multi screen modes.

### 6. ZOOM

Press ZOOM to enlarge the picture display 2x.

### 7. This button has two functions: PIP & Motion Detection

(a) Press the PIP button to change to Picture in Picture mode.

(b) When you are in the Camera Channel Setup Menu and Motion Detection is activated it turns all targets on the screen ON or OFF.

### 8. 4/7 channel display mode

### 9. 9 channel display mode

### 10. REC

Press REC to start recording.

### 11. STOP / Down

- STOP: Under the DVR Record / Play mode, it can stop the moment action.
- DOWN: When in the setup mode, it works as the Down directional button.

### 12. POWER

Press Power to turn ON / OFF the DVR.

### 13. FF / Right

FF: It can play video forward at high speed, and press FF again to adjust speed from 1, 2, 4, 8, 16, 32 times.  
Right: When in the setup mode, it can work as the Right directional button.

### 14. PAUSE / Up

Pause: Under the DVR play mode, it can pause the action.



UP: When in the setup mode, it works as an Up directional button.

15. **PLAY**

Press PLAY to playback the most recently recorded video.

16. **REW / Left**

REW: Under DVR play mode, it can play video backward at different speeds. (Press REW again to adjust speed as 1, 2, 4, 8, 16, 32 times)

Left: When in the setup mode, it works as Left directional button.

17. **SLOW**

Press to slow down the playback speed.

18. **CAMERA SELECT (1-9)**

Press the Camera Select (1-9) to select specified camera.

## Back Panel Connections

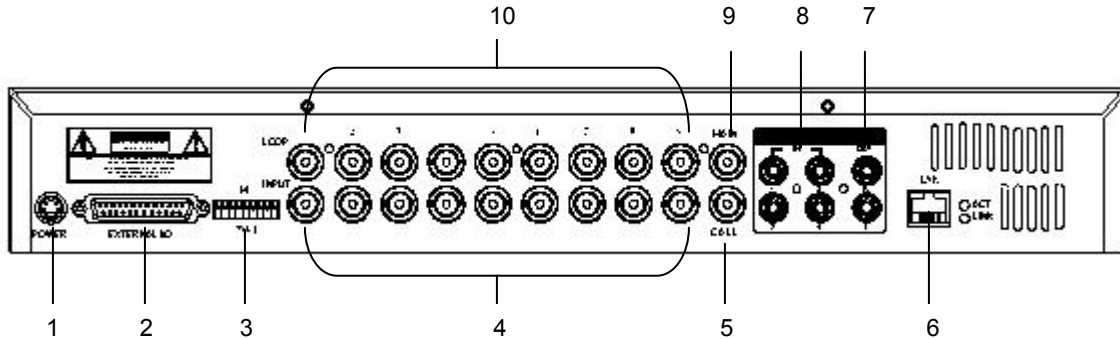

1. **POWER INPUT**  
Connects to the Power cord.
2. **EXTERNAL I/O**  
Connects to a PC for Remote Control via RS-232 or to an Alarm Block. (see Appendix #3 for more info)
3. **75/HI**  
When using the LOOP function, allows for HI impedance or 75ohms.
4. **VIDEO INPUT (1-9)**  
Connects to a video source (i.e. camera).
5. **CALL**  
Connects to the CALL monitor for real time sequencing.
6. **LAN**  
Connects DVR by LAN cable.
7. **AUDIO OUTPUT (R/L)**  
Connects to monitor or speaker (2 mono audio outputs from the same source)
8. **AUDIO INPUT (1-4)**  
Connects to an audio source such as a microphone for recording purposes (4 audio inputs, but only 1 can be selected during recording).
9. **MAIN**  
Connects to the main display monitor.
10. **LOOP (1-9)**  
Allows connection to other video devices.

## Accessing the Main Menu

The Menu allows you to configure your DVR settings and program various recording options. Follow these steps in order to access the Menu:

Press the **MENU** button. The password screen will appear:

Password: 0000

**The default Password is 0000.**

To change the number of the Password, use the ◀ / ▶ buttons to scroll left and right between numbers, and use the ▲ / ▼ buttons to change the value of the number that is flashing.

Press the **ENTER** button once the correct Password is entered. The menu options screen will appear.

**NOTE:** If you get a message "Password Error", you have entered an incorrect password.

### Main Menu

When the correct password is entered, the Main Menu options will be displayed.

There are 7 options available in the Main Menu:

- Search:** Finds recorded list
- Timer:** Scheduling recording
- Record:** Record mode setup
- Camera:** Camera channel setup
- System:** System setup (sets the date, chooses an HDD overwrite setting, changes password, resets system settings, or clears the HDD)
- Event:** Event List - Allows you to view video from a list of recorded events
- Network:** Network setup

(Menu)  
Search  
Timer  
Record  
Camera  
System  
Event  
Network

### **Navigating the Menu:**

- ▲ / ▼: Scroll up and down through menu options; change values when an option is selected and is blinking
- ◀ / ▶: Scroll sideways within a menu option that has been selected

**ENTER:** Selects a submenu / an option in a submenu for browsing / modification

**MENU:** Completes modification of a menu option; exits a menu

**NOTE:** The Menu setup will timeout after 1 minute of no key presses.

### Search

The DXR209 allows you to easily find sections of recorded video using the **SEARCH** feature.

To access the Search option, press **MENU** followed by the 4 digit password. Use the ▲ / ▼ to scroll to the **Search** option and press **ENTER**.

(Menu)  
▶ Search  
Timer  
Record  
Camera  
System  
Event  
Network

The following options are available in the Search Menu:

► Last Record  
Full List  
Alarm List  
Motion List  
Time Search

### Last Record

This feature is used to play the last recorded piece of video.

- In the Search menu, press ▲ / ▼ to scroll to the Last Record option, then press **ENTER**.
- The last recorded video will begin playing.

### Full List

This feature is used to choose from a listing of all recorded video on the HDD sorted by time.

1. In the Search menu, press ▲ / ▼ to scroll to the Full List option, then press **ENTER**.
2. Press ▲ / ▼ to select the desired recorded video and press ◀ / ▶ to change pages.
3. Press **ENTER** to play selected video.

```
► M 2002-JAN-01 01:02:03 M-HDD
M 2002-JAN-01 01:02:03 M-HDD
A 2002-JAN-01 01:02:03 M-HDD
T 2002-JAN-01 01:02:03 M-HDD
D 2002-JAN-01 01:02:03 S-HDD
M 2002-JAN-01 01:02:03 S-HDD
◀: Page Up ▶: Page Down
```

An example of a Full List search is shown on the left.

Note that the date and time appear, along with the letter representing the method of recording that took place.

Press **ENTER** to view a selected piece of video on the list. The DXR209 will play the video in chronological order, until it hits the End of the list. Playback can be stopped at any time by pressing the **STOP** button.

D: Motion Recording

M: Manual Record Time  
A: Alarm Record Time  
T: Timer Recording  
M-HDD: Storage in Master HDD  
S-HDD: Storage in Slave HDD

### Alarm List

This feature shows a listing of all recorded video triggered by an Alarm.

1. In the Search menu, press ▲ / ▼ to scroll to the Alarm List option, then press **ENTER**.
2. Press ▲ / ▼ to select the desired recorded video and press ◀ / ▶ to change pages.
3. Press **ENTER** to play selected video.

### Motion List

This feature shows a list of all triggered motion detections.

1. In the Search menu, press ▲ / ▼ to scroll to the Motion List option, then press **ENTER**.
2. Press ▲ / ▼ to select the desired recorded video and press ◀ / ▶ to change pages.
3. Press **ENTER** to play selected video.

### Time Search

This feature finds video recorded on a specific time and date that is entered.

1. In the Search menu, press ▲ / ▼ to scroll to the Time Search option, then press **ENTER**.
2. Press ▲ / ▼ to select the desired time and date, and press ◀ / ▶ to move to the next character.
3. Press **ENTER** to play selected video.

**NOTE:** If there is no record found that matches the selected time and date, the screen will display “**NOT FOUND**”.

## Timer Recording Setup

On the Main Menu, selecting the Timer option will allow you to set daily schedules in which you would like the DVR to automatically record.

Pressing **ENTER** after scrolling to the Timer option will bring up the following menu options:

### Timer

Day	Start	End	QUALITY	IPS
Daily	01:00	02:00	BEST	25A
SUN	12:00	13:00	BEST	15
MON	08:00	09:00	HIGH	10
MO~FR	00:00	01:00	NORMAL	2
SA~SU	20:00	21:00	BASIC	25A
JAN-01	15:00	16:00	NORMAL	8
Timer Enable:	No			

Example: If you want to record from Tuesday at 8 pm (21:00) to Wednesday at 9 am (09:00) you will need to make two separate entries

Day	Start	End
TUE	21:00	23:59
WED	24:00	09:00

(Menu)  
Search  
▶ Timer  
Record  
Camera  
System  
Event  
Network

- Press **▲ / ▼** to select the day(s) to record on, the available options are:
  - Daily:** Everyday
  - SUN:** Sunday
  - MON:** Monday
  - TUE:** Tuesday
  - WED:** Wednesday
  - THU:** Thursday
  - FRI:** Friday
  - SAT:** Saturday
  - MO-FR:** Monday to Friday
  - SA-SU:** Saturday & Sunday
  - JAN-01:** Special Date
  - OFF:** Not activated
- Use the **◀ / ▶** scroll keys to move to START record time 00:00 (HH:MM)  
Press **▲ / ▼** to set the start time
- Press **◀ / ▶** move to END record time 00:00 (HH:MM)  
Press **▲ / ▼** to change END record Time numerical digit
- Press **◀ / ▶** move to QUALITY  
Press **▲ / ▼** to choose options of  
**BEST, HIGH, NORMAL, BASIC**
- Press **◀ / ▶** move to Record IPS (Images Per Second)  
Press **▲ / ▼** to choose one of the following options  
**NTSC: 25A, 15, 8, 4, 2, 1**  
**PAL: 18A, 12, 6, 3, 2, 1**  
**Note: the letter "A" means, "Record with Audio"**
- Press **MENU** to confirm current operation, and enter to next Timer Record setup.
- Press **◀ / ▶** move location to Timer Enable, Yes or No setup  
**YES** : To confirm Timer Enable/Scheduling Timer Record feature  
**NO** : To confirm no Timer Enable/No Scheduling Timer Record feature
- Press **MENU** to exit and confirm current operation.
- Press **MENU** again to exit and close TIMER setup mode.

**NOTE: WHEN THE TIMER IS SET, THE REC LED INDICATOR WILL BE ON. ALTHOUGH THE LIGHT MAY BE ON, THE SYSTEM IS NOT NECESSARILY RECORDING SINCE IT WILL ONLY RECORD DURING ITS SCHEDULED TIME.**

## Record Settings

On the Main menu, selecting the Record option will allow you to set the quality and speed of recordings.

Pressing **ENTER** after scrolling to the Record option will bring up the following menu options:

(RECORD)  
HDD Overwrite: NO  
Record IPS: 25A  
Record Quality: Normal  
Alarm Rec IPS: 25A  
Alarm Rec Quality: Normal  
Motion Trigger Record: ON

(Menu)  
Search  
Timer  
▶ Record  
Camera  
System  
Event  
Network

### HDD Overwrite Setup

1. Press **ENTER** to confirm HDD OVERWRITE setup.
2. Press **▲ / ▼** to choose HDD OVERWRITE.  
**NO:** When HDD full will stop recording  
**YES:** When HDD full will overwrite the HDD recording
3. Press **MENU** to exit and confirm current operation.
4. Press **MENU** again to exit and close HDD OVERWRITE setup mode.

### Record IPS Setup

1. Press **ENTER** to confirm RECORD IPS setup.
2. Press **▲ / ▼** to choose IPS record speed. *Note that '25A' indicates 25 ips with audio.*  
**NTSC: 25A, 15, 8, 4, 2, 1**  
**PAL: 18A, 12, 6, 3, 2, 1**
3. Press **MENU** to exit and confirm current operation.
4. Press **MENU** again to exit and close RECORD IPS setup mode.

### Record Quality Setup

1. Press **ENTER** to confirm Record Quality setup.
2. Press **▲ / ▼** to choose Record Quality level.  
**BEST, HIGH, NORMAL, BASIC**
3. Press **MENU** to exit and confirm current operation.
4. Press **MENU** again to exit and close RECORD QUALITY setup mode.

### Alarm REC IPS Setup

1. Press **ENTER** to confirm ALARM REC IPS setup.
2. Press **▲ / ▼** to choose ALARM REC IPS record speed.  
**NTSC: 25A, 15, 8, 4, 2, 1**  
**PAL: 18A, 12, 6, 3, 2, 1**
3. Press **MENU** to exit and confirm current operation.
4. Press **MENU** again to exit and close ALARM REC IPS setup mode.

### Alarm REC Quality Setup

1. Press **ENTER** to confirm ALARM REC QUALITY setup.
2. Press **▲ / ▼** to choose ALARM REC QUALITY level.  
**BEST, HIGH, NORMAL, BASIC**
3. Press **MENU** to exit and confirm current operation.
4. Press **MENU** again to exit and close ALARM REC QUALITY setup mode.

### **Motion Trigger Record**

1. Press **ENTER** to confirm MOTION TRIGGER RECORD setup.
2. Press **▲ / ▼** to toggle the option between ON and OFF.

1. Select "**ON**" to set up the motion trigger recording: It can automatically switch from stand-by mode to Recording Mode. The motion detection will change the scanning sequence and show  "D" on the monitor.



**NOTE:** The trigger recording time will depend on the ALARM DURATION mode setting. It will record from the last trigger time. For example, when the alarm duration setting is 1 min, the time recording time is from 9:00:00 to 9:01:00.

If the motion detection triggered again at 9:00:40, the triggered recording time will from 9:00:00 to 9:00:40 and 9:00:40 to 9:01:40. The total recording time is 00:01:40.

2. Select "**OFF**": The screen shows  the motion detection and will change the scanning sequence while in the recording mode and show "M" on the monitor.

### **Camera Channel Setup**

To access the Camera option, press **MENU** followed by the 4-digit password. Use the **▲ / ▼** to scroll to the Camera option and press **ENTER**.

TITLE	DWELL				ALARM	RECORD
---01	ON	5	5	5	LOW	EVENT
---02	ON	5	5	5	LOW	EVENT
---03	ON	5	5	5	LOW	EVENT
---04	ON	5	5	5	LOW	EVENT

The options available in this section are as follows:

#### **Title**

This feature is used to assign a 6-character title to each camera input.

1. Press **▲ / ▼** to select the desired time camera channel (1-9), and then press **ENTER**.
2. Press **▲ / ▼** to select the desired character and **◀ / ▶** to move to the next character
3. Press **MENU** to confirm and exit the **Title** setting.
4. Press **MENU** again to exit the Camera Setup Option.

#### **Dwell**

This feature is used to enable or disable the dwell feature for each camera when viewing using the call monitor output.

1. Press **▲ / ▼** to select the desired time camera channel (1-9), then press **ENTER**.
2. Press **◀ / ▶** to select the **Dwell** feature on the screen.
3. Press **MENU** to confirm and exit the dwell setting.
4. Press **MENU** again to exit the Camera Setup Option.

#### **Brightness / Contrast / Color**

This feature is used to adjust the video settings on each channel.

1. Press **▲ / ▼** to select the desired time camera channel (1-9), then press **ENTER**.
2. Press **◀ / ▶** to select the **Brightness, Contrast, or Color** feature on the screen.
3. Press **▲ / ▼** to select **0-9** on the screen.
4. Press **MENU** to confirm and exit the **Brightness, Contrast, or Color** control feature
5. Press **MENU** again to exit the Camera Setup Option.

#### **Alarm Polarity**

This feature is used to select the alarm polarity as LOW / OFF / HIGH.

1. Press **▲ / ▼** to select the desired time camera channel (1-9), then press **ENTER**.
2. Press **◀ / ▶** to select the **Alarm Polarity** feature on the screen.
3. Press **▲ / ▼** to select **LOW / OFF / HIGH** on the screen.
4. Press **MENU** to confirm and exit the **Alarm Polarity** feature
5. Press **MENU** again to exit the Camera Setup Option.

### **Record Method**

This feature is used to select the DVR record method as either EVENT / NORMAL / OFF.

1. Press ▲ / ▼ to select the desired time camera channel (1-9), then press **ENTER**.
2. Press ◀ / ▶ to select the **Record Method** feature on the screen.
3. Press ▲ / ▼ to select **EVENT/ NORMAL/ OFF** on the screen.

**EVENT:** When the alarm input is triggered, the DVR will increase the recording time to that channel.

i.e. the normal record sequence for cameras is Camera 1, Camera 2, Camera 3 etc. In Event mode, when an alarm is triggered from channel 1, the DVR will record using the following sequence: Camera 1, Camera 2, Camera 1, Camera 3, Camera 1, Camera 4 etc.

**NORMAL:** When an External Audible Alarm is triggered, the DVR will record normally as set up.

**OFF:** An Alarm Trigger will not cause the DVR to start recording.

4. Press **MENU** to confirm and exit the **Record Method** feature.
5. Press **MENU** again to exit the Camera Setup Option



**Motion Detection**

The Motion Detect feature provides a visual indication on the monitor when movement is detected in the picture. Also, if the 'Motion Trigger Record' option is enabled in the 'Record' menu, recording will activate on all cameras when motion is detected. Use the steps below to enable/disable the detection zones for each camera.

Press **MENU** to enter the menu set up, then **▼** to **CAMERA** setup.  
Press **ENTER** twice to enter the Motion Detection setup.

Each screen displays the current camera picture overlaid with the motion targets (as [Figure 1](#)). Pressing the **◀ / ▶**, **▲ / ▼** buttons will toggle the motion detection between **ON** or **OFF**.

The targets on each motion setup can be turned to ON or OFF individually by row. To set up targets, using the following front panel buttons:

1. Press **ENTER** to confirm the channel.
2. Press **ENTER** to enter motion mode.
3. **▲** moves the target cursor up one row at a time.
4. **▼** moves the target cursor down one row at a time.
5. **◀** moves the target cursor left one column at a time.
6. **▶** moves the target cursor right one column at a time.
7. Press **ENTER** to turn the target cursor ON.  
Press **ENTER** again to turn the target cursor OFF.
8. **Camera Select (1-15)** toggles the corresponding target on the cursor line ON or OFF. (see [Figure 1.1](#)) There are only 15 targets in a row, therefore; only Camera Selected (1-15) can be operated.
9. **Zoom**: turns all targets in the current row ON or OFF. ([Figure 1-2](#))
10. **PIP**: turns all targets on the screen ON or OFF. ([Figure 1-3](#))

Press **SLOW** button to setup the Sensitivity list up to 255

1. Press REC button to setup the Sensitivity list down to 000.
2. Sensitivity value is related to motion and brightness change.
3. Low value (as 001) means higher sensitivity on motion and brightness change.
4. High value (as 255) means lower sensitivity on motion and brightness change.  
User can choose the suitable sensitivity value in different locations. The default value is set on 32.

Figure 1 **MOTION DETECTION SETUP**

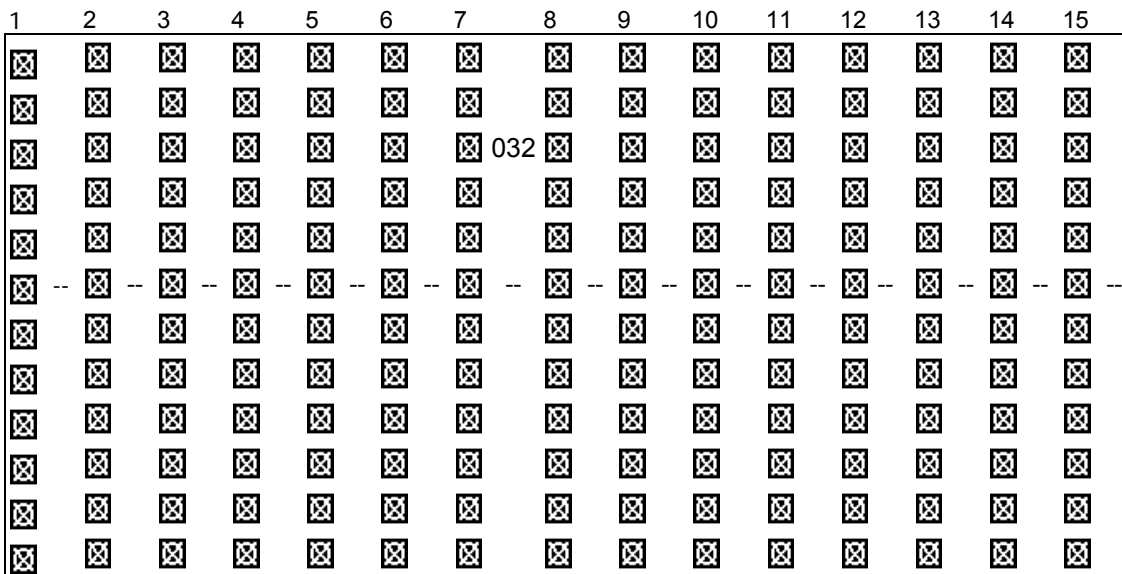

Figure 1-1 MOTION DETECTION SETUP – 1~9

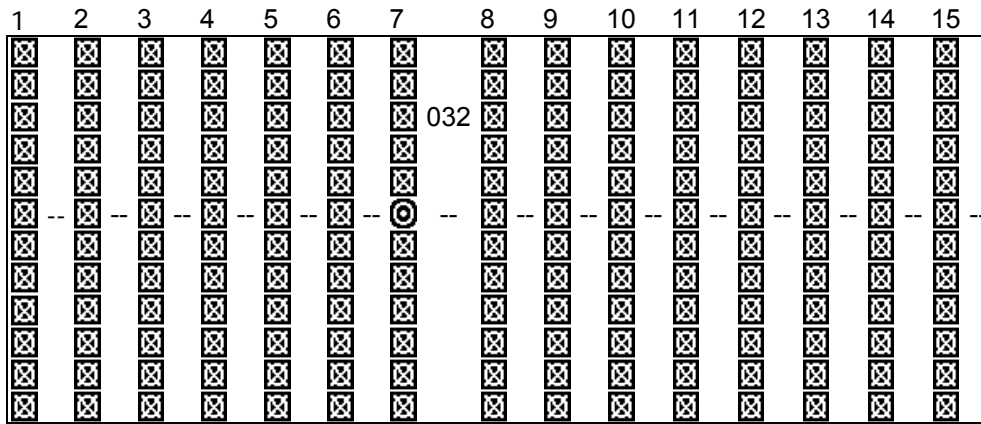

Figure 1-2 MOTION DETECTION SETUP – LINE

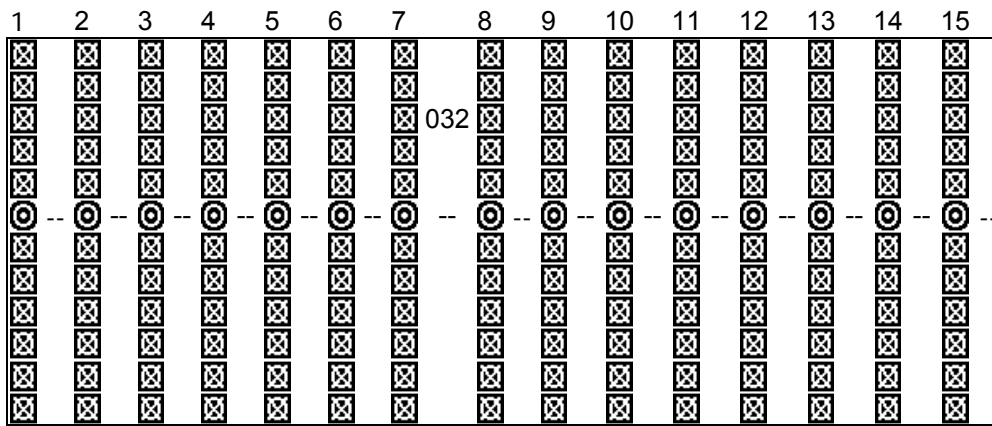
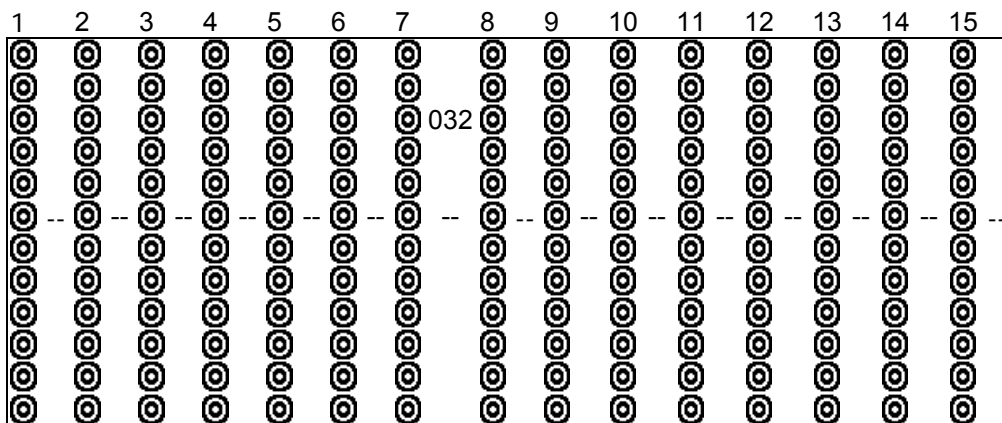

Figure 1-3 MOTION DETECTION SETUP – ALL



## System Setup

The System menu is used to configure the system level options on the DXR209.

To access the System features, press **MENU** followed by the 4-digit password. Use the ▲ / ▼ to scroll to the 'System' option and press **ENTER**.

(SYSTEM)	
Audio Input:	1
Int Audible Alarm:	ON
Ext Audible Alarm:	ON
Motion Audible Alarm:	ON
Alarm Duration:	10 SEC
Dwell Time:	02 SEC
Message Latch:	NO
Title Display:	ON
Time Display:	Y/M/D
2003-JAN-02 (THU)	17:37:09
New Password:	XXXX
Clear HDD:	NO
System Reset:	NO

Using the ▲ / ▼ buttons, scroll to the desired option and press **ENTER** to select it.

### Selecting the Audio Input Channel

This feature is used to select the audio channel to record. To set this Audio Input Channel:

1. On the System screen, press ▲ / ▼ to select Audio Input, then press **ENTER**.
2. Press ▲ / ▼ to select the desired time audio channel (1-4).
3. Press **MENU** to confirm your change.
4. Press ▲ / ▼ to move to another field on the System screen or press **MENU** to exit.

### Setting the Internal Audible Alarm Buzzer

To enable or disable the Internal Audible Alarm Buzzer: If enabled, the buzzer will sound when the external alarm input is activated.

1. On the System screen, press ▲ / ▼ to select Internal Audible Alarm Buzzer, then press **ENTER**.
2. Press ▲ / ▼ to enable or disable the Internal Audible Alarm Buzzer. Options are:  
**ON** = Buzzer is on. When the DVR detects an alarm, the system sounds the internal buzzer to alert the user.  
**OFF** = Buzzer is off.
3. Press **MENU** to confirm your change.
4. Press ▲ / ▼ to move to another field on the System screen or press **MENU** to exit.

### Setting the External Audible Alarm Device

To enable or disable the External Audible Alarm Device:

1. On the System screen, press ▲ / ▼ to select External Audible Alarm Device, then press **ENTER**.
2. Press ▲ / ▼ to enable or disable the External Audible Alarm Device. Options are:  
**ON** = External Device is on. When the DVR detects an alarm, the system triggers the external audible alarm.  
**OFF** = External Device is off
3. Press **MENU** to confirm your change.

4. Press **▲ / ▼** to move to another field on the System screen or press **MENU** to exit.

### **Setting the Motion Audible Alarm feature**

If enabled, the buzzer will sound if the video Motion Detect Feature is set and motion is detected.

1. On the System screen, press **▲ / ▼** to select Motion Audible Alarm, then press **ENTER**.
2. Press **▲ / ▼** to enable or disable the Motion Audible Alarm. Options are:  
**ON** = Buzzer will sound when motion is detected.  
**OFF** = The buzzer will remain silent when motion is detected.
3. Press **MENU** to confirm your change.
4. Press **▲ / ▼** to move to another field on the System screen or press **MENU** to exit.

### **Setting the Alarm Duration**

To set the duration of the Alarm:

1. On the System screen, press **▲ / ▼** to select Alarm Duration, then press **ENTER**.
2. Press **▲ / ▼** to select the desired time (10s, 15s, 20s, 30s, 1min, 2min, 3min, 5min, 10min, 15min, 30min, always)
3. Press **MENU** to confirm your change.
4. Press **▲ / ▼** to move to another field on the System screen or press **MENU** to exit.

### **Setting the Dwell Time**

This timer is used to select the amount of time (between 1-10s) a channel appears on the call monitor before sequencing to the next channel. To Set the Dwell Time:

1. On the System screen, press **▲ / ▼** to select Dwell Time, then press **ENTER**.
2. Press **▲ / ▼** to select the desired time (1-10s).
3. Press **MENU** to confirm your change.
4. Press **▲ / ▼** to move to another field on the System screen or press **MENU** to exit.

### **Setting the Message Latch Feature**

This feature determines if the On Screen messages will remain on the screen or disappear after 10s. To set the Message Latch:

1. On the System screen, press **▲ / ▼** to select Message Latch, then press **ENTER**.
2. Press **▲ / ▼** to enable or disable the Message Latch feature. Options are:  
**NO** = Screen messages will disappear after a 10 sec. (this is the default setting)  
**YES** = On Screen messages will remain on the screen for the duration of the event.
3. Press **MENU** to confirm your change.
4. Press **▲ / ▼** to move to another field on the System screen or press **MENU** to exit.

### **System Time/Date Set up**

#### **Selecting the Date Display Format**

1. On the System screen, press **▲ / ▼** to select Date Display, then press **ENTER**.
2. Press **▲ / ▼** to choose a display format. Options are:  
**Y-M-D** = Year - Month - Day  
**M-D-Y** = Month - Day - Year

**D-M-Y** = Day - Month - Year

**Off** = The date and time will not show on the screen.

3. Press **MENU** to confirm your change.
4. Press **▲ / ▼** to move to another field on the System screen or press **MENU** to exit this screen and confirm the current operation.

### Setting System Time & Date

1. On the System screen, press **▲ / ▼** to select System Time & Date, then press **ENTER**.
2. Press **▲ / ▼** to choose a number, then press **◀ / ▶** to move to the next digit:  
**2003-Jan-01 (Mon) 22:38:29**
3. Press **MENU** to confirm your change.
4. Press **▲ / ▼** to move to another field on the System screen or press **MENU** to exit this screen and confirm the current operation.

### Changing the System Password

1. On the System screen, press **▲ / ▼** to select New Password, then press **ENTER**.
2. Press **▲ / ▼** to choose a number, then press **◀ / ▶** to move to the next digit.
3. Press **MENU** to confirm your change.
4. Press **▲ / ▼** move to another field on the System screen or press **MENU** to exit this screen and confirm the current operation.
5. If you have completed all your system configuration changes, press **MENU** again to exit and close menu setup.

### Clearing the Hard Drive Data

This option will erase all data from the hard drive.

**Ensure that there are no important recordings on the disk before using this option.**

1. On the System screen, press **▲ / ▼** to select Clear HDD, and then press **ENTER**.
2. Press **▲ / ▼** to choose YES to clear the HDD or NO to leave as is.
3. When you choose "Yes" on this option and press **ENTER**, the DVR will prompt:
4. Press **▶** to confirm clearing, or **◀** to cancel.
5. Press **MENU** to confirm your change.
6. Press **▲ / ▼** to move to another field on the System screen or press **MENU** to exit this screen and confirm the current operation.

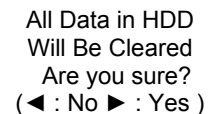

All Data in HDD  
Will Be Cleared  
Are you sure?  
(◀ : No ▶ : Yes)

**NOTE:** Clearing the data from the Hard Drive results in permanent, irreversible loss of all video and related data currently stored on the Hard Drive.

### Resetting System to Factory Defaults

Using the System Reset option will set all options back to factory default settings. Use the steps below to perform this option:

1. On the System screen, press **▲ / ▼** to select System Reset, and then press **ENTER**.
2. Press **▲ / ▼** to choose:  
**Yes** = Confirm the system reset and load the default settings.  
**No** = Do not reset the system at this time.
3. Press **MENU** to exit this screen and confirm the current operation.

If you have completed all your system configuration changes, press **MENU** again to exit and close menu setup.

**NOTE:** This will not affect the time and date settings.

## Event Log Viewing

To access the Event Log Viewing option, press **MENU** followed by the 4-digit password. Use the ▲ / ▼ to scroll to the **Event** option and press **ENTER** to view the list of logged events.

Use the ▲ / ▼ to scroll through the events on the display and ◀ / ▶ to go to the next page. To view the video associated with an event, scroll to the event and press **ENTER**.

The following is a list of events that can be displayed on the DXR209.

**M-HDD WARNING:** Master HDD might be failed  
**M-HDD LOSS:** Master HDD does not exist. User can use other HDD.  
**M-HDD ERROR:** Master HDD may contain error.  
**S-HDD WARNING:** Slave HDD may have failed.  
**S-HDD LOSS:** Slave HDD does not exist. User can use other HDD  
**S-HDD ERROR:** Slave HDD may contain error.  
**HDD FULL:** HDD is full.  
**SYSTEM ERROR:** System may have failed.  
**-----02 VLOSS:** Channel: 2 Video Loss  
**-----03 ALARM:** Channel: 3 External I/O Alarm triggered.  
**POWER RESTORE:** Power restore.

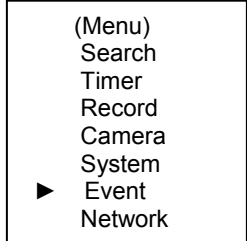

## Network

To access the network option, press the **MENU** and use the ▲ / ▼ to scroll to the **NETWORK** option and press **ENTER** to view the list of options.

The following is a list of network options that is displayed on the DXR209.

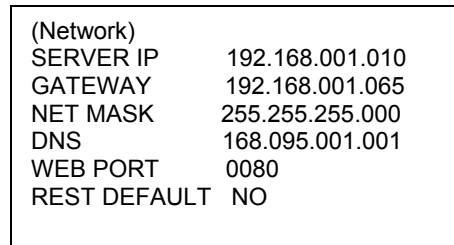
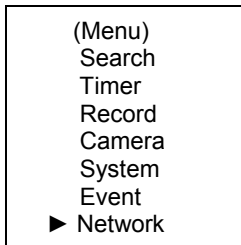

To obtain the following network addresses listed in the Menu screen above, please follow the software installation in the next section.

## Operation

### On Screen Display (OSD)

The DXR209 will display all current status on the OSD.

Here is an example of the display.

The following status will be shown:

**Time and Date** – The current time and date will be shown on the first line.

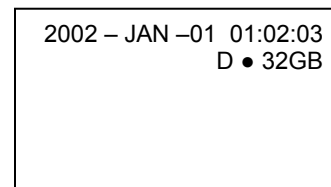

**Record Type** – The current recording method will be shown:

M= Manual, T= Timer, A= Alarm, D= Motion

**Record Status** – An ● icon will be displayed when the unit is currently recording.

**HDD Status** – This will display either the remaining HDD capacity in GB or OW to indicate that it is set to Overwrite.

**Video Loss** - Screen will display  if the video input is not connected properly.

## Recording Methods

The DXR209 offers a variety of flexible recording modes. The unit can be set up to record continually, following a schedule, or by record events. In addition, the recording speed and resolution is also configurable (*these options are configurable through the system menu*). Under the recording status, if power is stopped accidentally, recorded video will still be stored in the HDD and will be available when the power is restored, and the original recording setup will remain.

When recording, the top line of the display will show the date, time, and the amount of available HDD memory (in GB).

In the example below, the letter “A” represents the alarm trigger and the letters “OW” represents HDD over write.

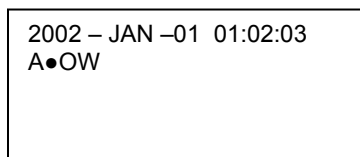

There are 4 record modes for DXR209: Alarm Record, Timer Record, Manual Record and Motion Trigger Record.

1. **Alarm Record**  
The display will indicate a recording triggered by an Alarm using the letter “A”.
2. **Timer Record**  
The display will indicate a scheduled recording using the letter “T”.
3. **Manual Record**  
The display will indicate a manual recording (by pressing the REC button) using the letter “M”.
4. **Motion Trigger Record**  
Recording will be triggered by motion sensing and is indicated with the letter ‘D’.



## Viewing Options:

### **Individual Camera Select (1 - 9):**

Press Camera Select (1 - 9) button to select the desired camera to display in full screen mode.

### **Multi View Select:**

This button is used to select the ideal viewing configuration.

1. Press the    buttons to toggle the camera views.

### **Picture in Picture (PIP):**

This button is used to configure the monitor so a full screen is displayed in the background with a 1/16th size screen insert.

1. Press the  button to display the **PIP** mode.
2. Press **SELECT** then ◀ / ▶ button to move the insert screen.
3. Press **MENU** to exit.

### **Zoom:**

Feature is used to enlarge the display (2X) the size of the main picture. The screen will now display the “zoomed” picture as the main picture with a small window inserted containing a moveable 1/4 view size of the appointed camera.

1. Select the desired camera by pressing Camera Select (1-9).
2. Press the **Zoom** button to zoom the image on the display.
3. Press the **Zoom** button again to move the zoom pointer.
4. Press **MENU** to exit.

## Video Search

The DVR allows you to easily find sections of recorded video using the Search feature.

Press the SEARCH button and you will see the following options:

► Last Record  
Full List  
Alarm List  
Time Search

**Last Record:** Plays the last recorded piece of video.

**Full List:** Shows a listing of all recorded video on the HDD, sorted by time.

**Alarm List:** Shows a listing of all recorded video triggered by an Alarm.

**Time Search:** Finds video recorded on a specific date that is entered.

```
► M 2002-JAN-01 01:02:03 M-HDD
M 2002-JAN-01 01:02:03 M-HDD
A 2002-JAN-01 01:02:03 M-HDD
T 2002-JAN-01 01:02:03 M-HDD
E 2002-JAN-01 01:02:03 S-HDD
M 2002-JAN-01 01:02:03 S-HDD
◀: Page Up ▶: Page Down
```

An example of a Full List search is shown on the left.

Note that the date and time appear, along with the letter representing the method of recording that took place.

Simply press ENTER to view a selected piece of video on the list. The DVR will play that video, followed by the next video in chronological order, until it hits the End of the list. You can stop the video at any time by pressing the STOP button.

## Playing Back Video

Pressing **PLAY** while in Normal operation will play back the most recently recorded video clip. The controls below will allow you further controls over the playback whether in this mode or when viewing video from the Search mode.

- Fast Forward -** Press **PLAY** on the front panel, then press **FF/►** to open the fast forward search screen. Press **FF/►** once to increase the speed to 2X, twice to increase the speed to 4X, and so on. The maximum fast forward speed is 32X.
- Fast Reverse -** Press **PLAY** on the front panel, then press **REW/◀** to open the fast reverse search screen. Press **REW/◀** once to increase the reverse speed to 2X, twice to increase the reverse speed to 4X, and so on. The maximum fast rewind speed is 32X.
- Slow Forward -** Press **PLAY** on the front panel, then press **SLOW** for slow play. Press **FF/►** to play images at slow speed (1/2X). Press **FF/►** again to slow the speed to 1/4X. Continue to press **FF/►** to slow down the speed. The minimum slow speed is 1/32X.
- Slow Reverse -** Press **PLAY** on the front panel, then press **SLOW** for slow forward. Press **REW/◀** to play images slowly forward (1/2X). Press **REW/◀** again to slow the speed to 1/4X. Continue to press **REW/◀** to slow down the speed. The minimum slow forward speed is 1/32X.
- Image Jog -** Press **PLAY** on the front panel, then press **PAUSE** to lock the current image on the screen. Press **FF/►** to select single image play. Each time you press **FF/►** the next image will display. Continuing to press **FF/►** will result in forward image-by-image playback. Pressing **REW/◀** will result in reverse image by image playback.
- Pause -** Press **PLAY** on the front panel, and then press **PAUSE/▲** to lock the current image on the screen.
- Stop -** Press **STOP** on the front panel whenever you want to return the **DVR** to live monitoring mode.



## Hardware Connection from DVR

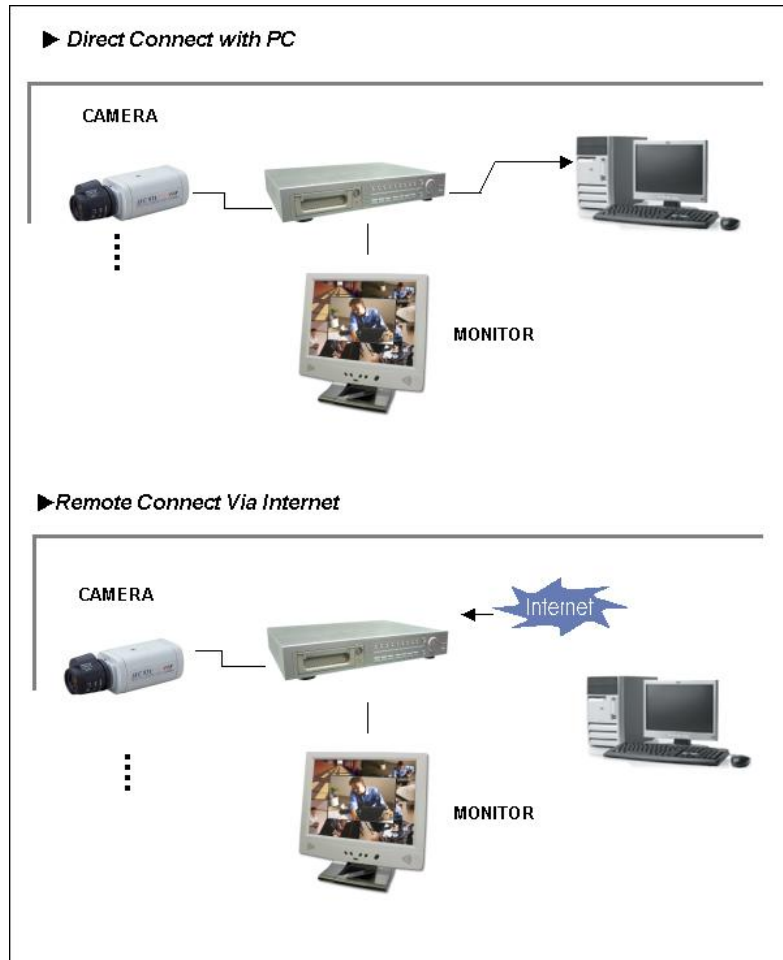

## Static IP Setting

### STEP 1: SOFTWARE INSTALLATION – STATIC IP SETTING:

1. Put the attached CD into the CD-ROM. The application program will install on your PC.  
Note: The CD contains a self-running installation that automatically starts when the CD is inserted. Follow the instructions for installation as indicated in the next few pages.
2. Press "Next".

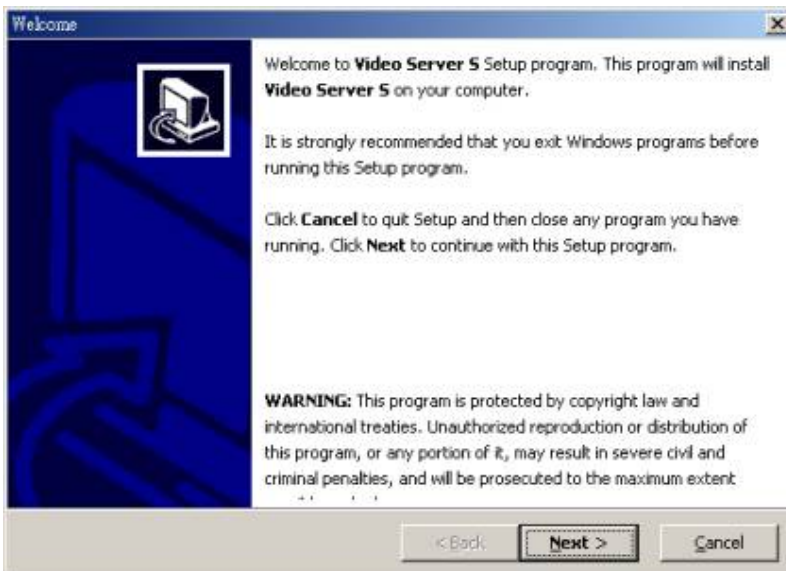

3. Choose the destination location and press "Next".

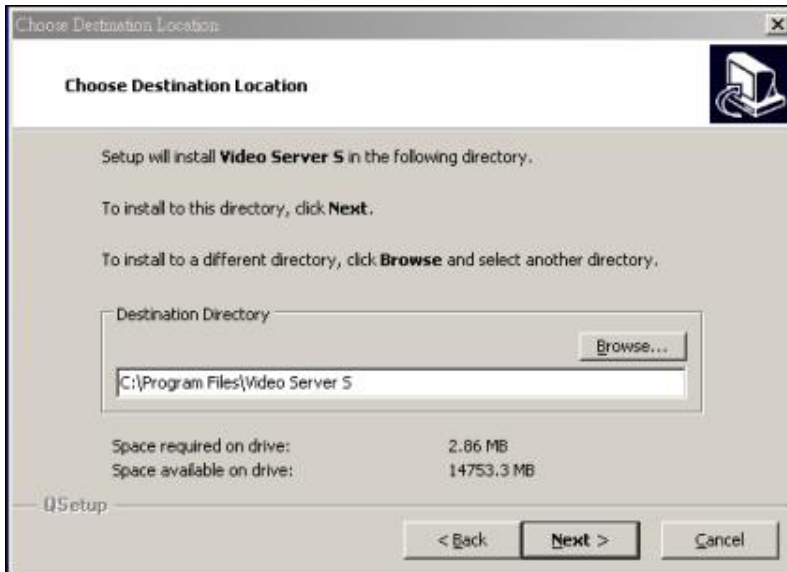

4. Set the program shortcut setting and press "Next".

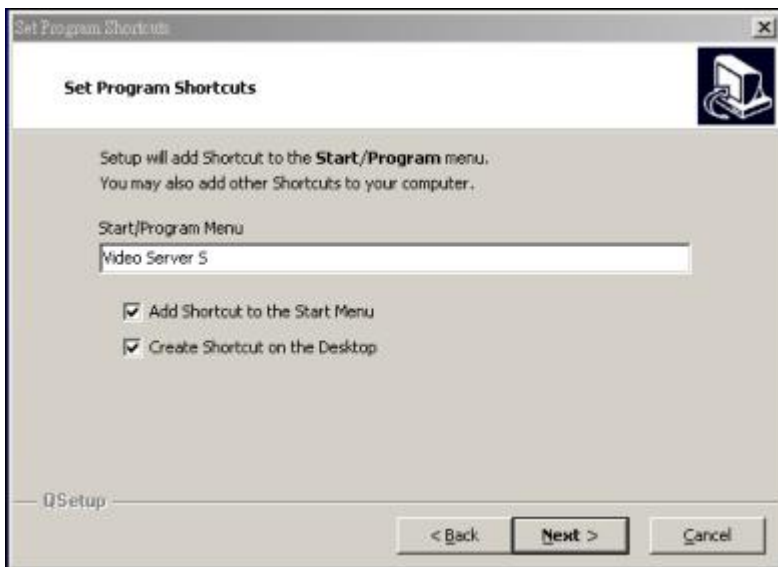

5. Press "Next" to begin copying the files.

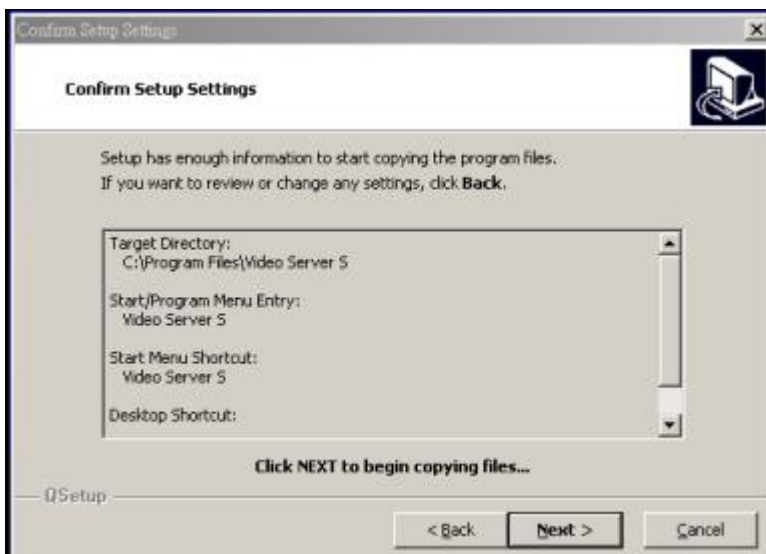

6. After the installation, the following files listed below will appear in your assigned path or file folder. There will be 6 files and 1 folder.



**STEP 2: STATIC IP SETTING**

In the DVR MENU / NETWORK set the IP ADDRESS, GATEWAY, NET MASK, DNS and WEB PORT as provided from your local ISP (internet service provider).

Below is an example of the settings required:

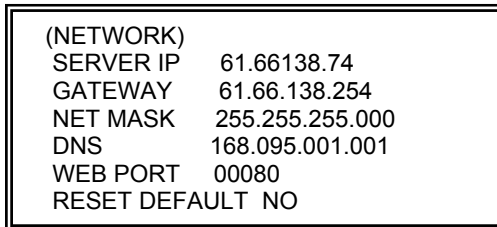

When all of the network settings are finished, connect the DVR to the internet (computer).

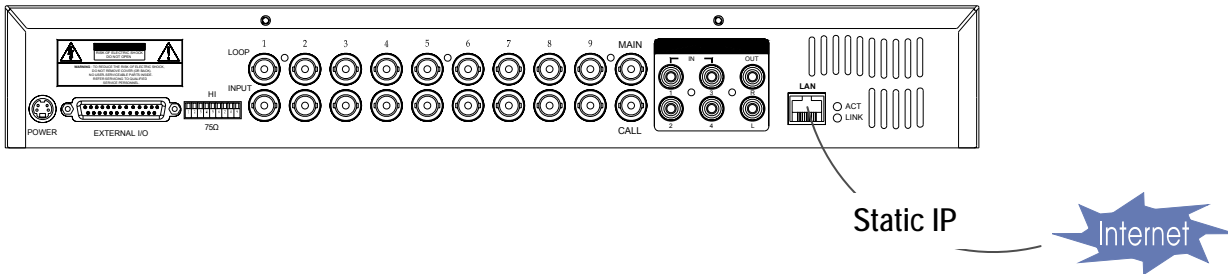

**STEP 3: Connecting the PC and DVR via the Internet**

1. To configure the Server IP, please click  twice to enter the setup.
2. Key in the User Name, Password, and Server IP (The default setting for the User Name is **admin** and the default Password is **admin** ; Server IP is the address that you set in Step 2). Click on OK to connect.



## Dynamic IP Setting

### WHAT IS A DYNAMIC IP ADDRESS?

A Dynamic IP Address is an IP (Internet Protocol) address that changes each time you connect to the internet. This cuts down on the number of IP addresses large consumer providers need because not all of their customers are using the service at any given time. It also cuts down on bandwidth usage by preventing consumers from hosting servers. Note: a number of companies have started to offer services aimed at updating DNS for dynamically connected clients.

### STEP 1: SOFTWARE INSTALLATION – DYNAMIC IP SETTING:

Follow the same procedure as outlined on Page 19 for the Static IP Setting.

### STEP 2: DDNS REGISTRATION FOR A DYNAMIC IP ADDRESS:

1. You must have a gateway router that supports DDNS (Dynamic Domain Network Service). Please go to [www.dlink.com](http://www.dlink.com) or [www.linksys.com](http://www.linksys.com) for a list of available routers.  
To register for a dynamic IP address click on the free site “<http://www.dyndns.org>” and click on “Account” (please look at the example below).



2. Click on “Create Account”.



3. Register your information (Username, E-mail address & password). Click on “Create Account” when the necessary information is completed.

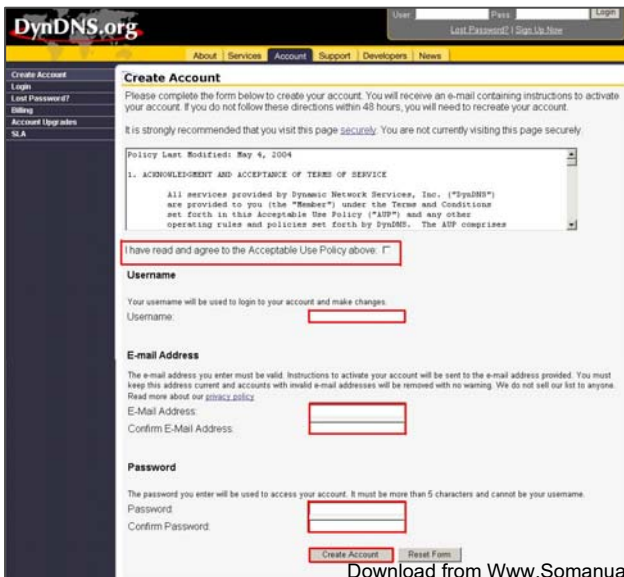

- After registering your account, you will receive an e-mail, which contains instructions to activate your account. If you do not follow these directions within 48 hours, you will need to re-register your account.
- Login your account.



- Click on "Account" and "Add Host"

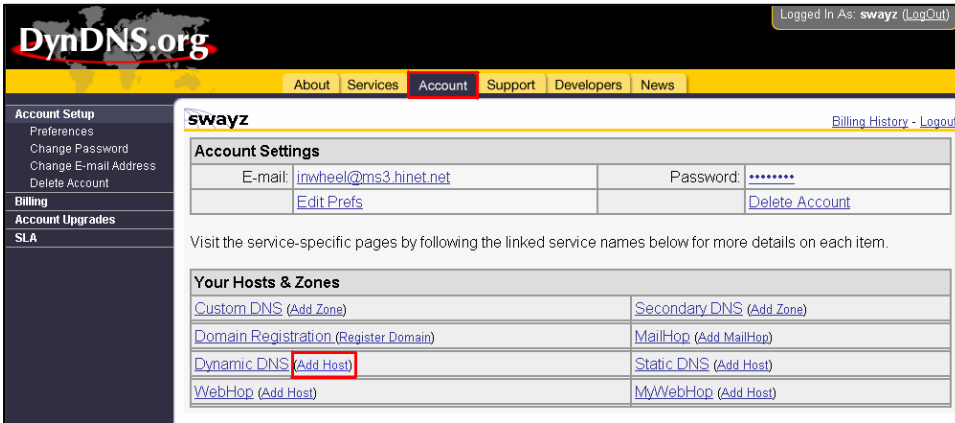

- Users can set up their own DDNS HOST. For example, the user's Host name is "Lorex.dyndns.org". Click on "Add Host" to finish the setting. **(NOTE: Some routers don't support some DDNS HOSTs)**

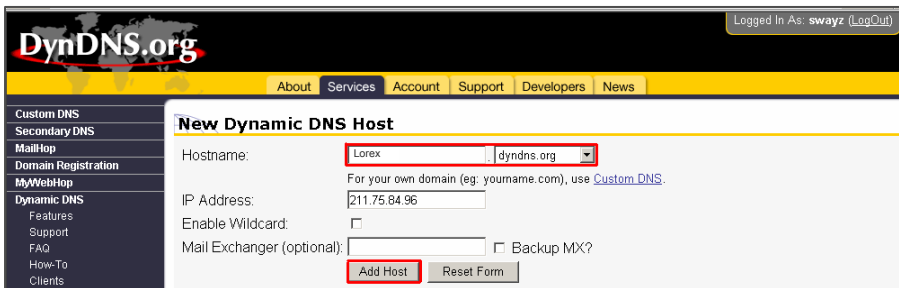

### STEP 3: CONNECTING THE PC TO A ROUTER / ROUTER LOGIN:

NOTE: The following settings are different from router to router. Please read the instructions on your router thoroughly.

- Connect the PC to the router using the LAN cable (LAN end).

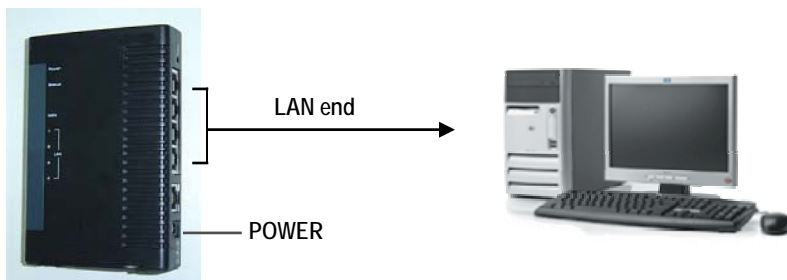

2. Network setting for PC. (The instruction is based on Win XP O/S. If your O/S is Win 2000 or Win 2003, the setup procedure is similar to that of Win XP O/S.)

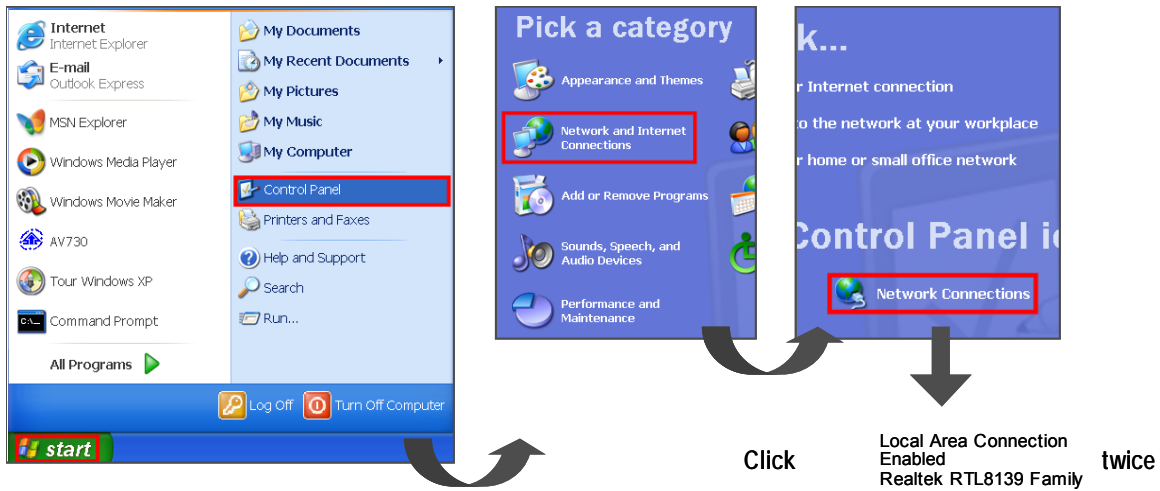

3. Click on "Properties" for TCP/IP setup.

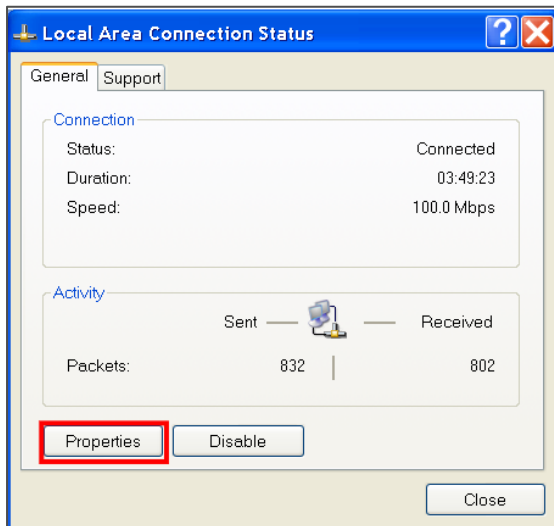

4. Click on "INTERNET PROTOCOL (TCP/IP)" and then select "Properties" to setup.

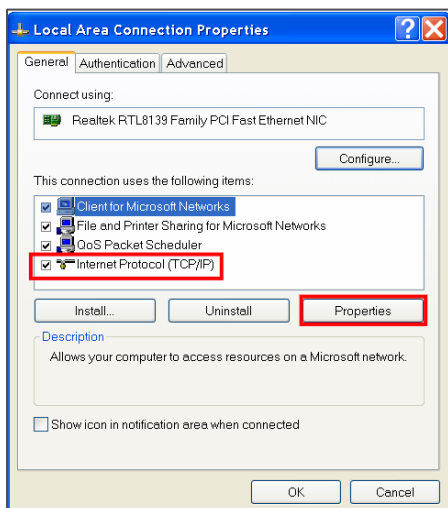

5. Choose "Obtain an IP address automatically".

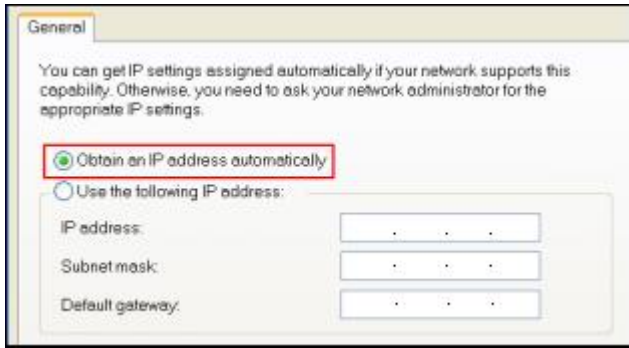

6. Enter the "Command Prompt".



7. In the setting window, enter " ipconfig", and write down the router's gateway (e.g. 192.168.1.1).

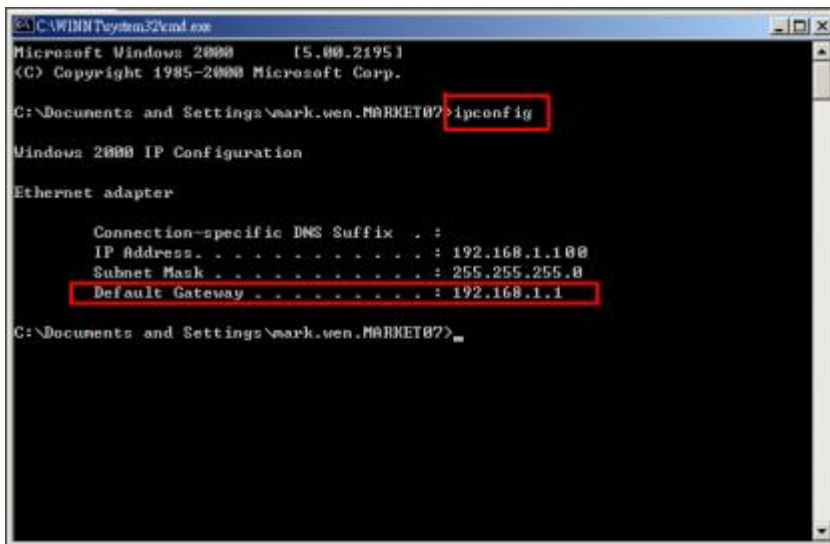

8. Close the window above. Enter the IP address (router's gateway: 192.168.1.1) to log in to the router from the Internet Explorer. Enter the login web page and key in the router's user name and password.





**STEP 4: ROUTER SETTING (Please refer to your Router manual for the configuration)**

NOTE: In the router setting, there are four steps to follow:

1. Dial setting
2. DHCP setting
3. Virtual server setting
4. DDNS setting

1. Click on "INTERNET PORT" and choose your WAN type (e.g. PPPoE). Enter your "User Name" and "Password" to dial up the dynamic IP address. Press save after you set up.

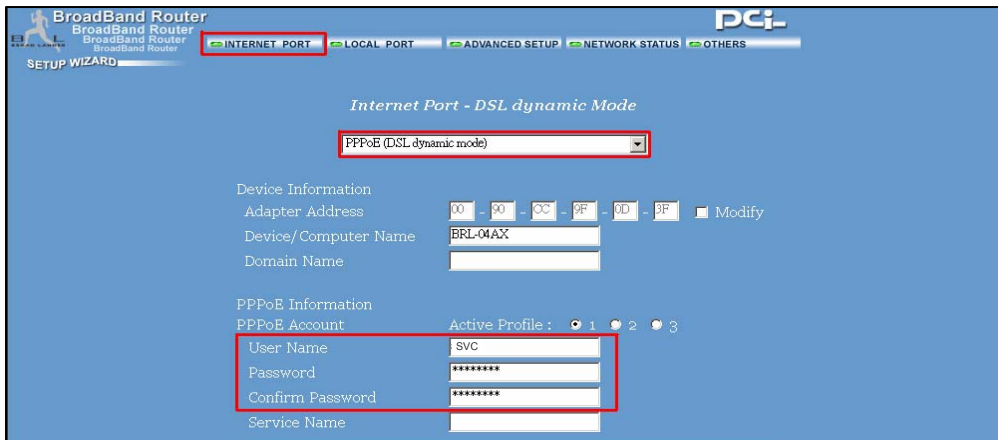

2. Press "LOCAL PORT" and set "Start IP address" and "Number of IP address". (For example, if the IP address of your Video Web Server is 192.168.1.10, then 10 is excluded from the setting range.) Press save after you finish setting up.

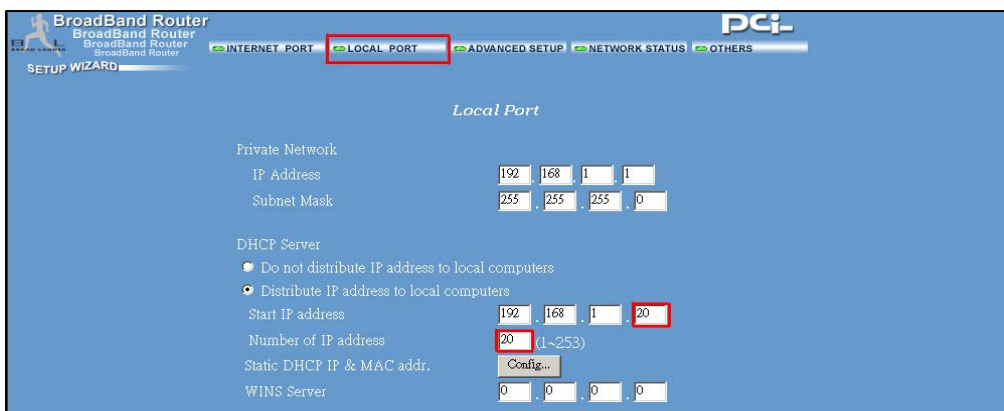



3. In the “ADVANCED SETUP / Virtual Server”. Choose “By Port” and set the “Port Number” to 80 for the Video Web Server. Set the “Local Server IP Address” to 192.168.1.10. (The default Video Web Server IP and port). Press add & save after you set up.

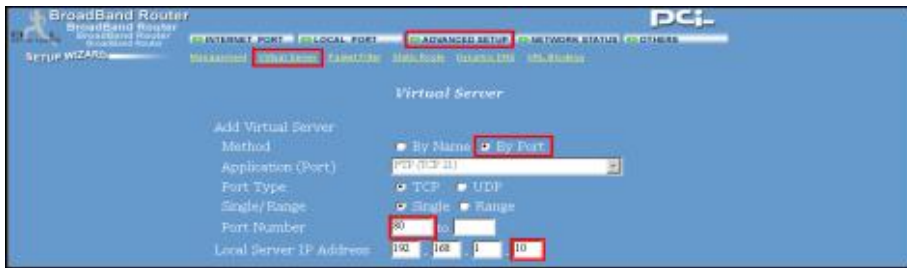

4. In the “ADVANCED SETUP / Dynamic DNS”, key in the “DNS Account”, “User Name” and “Password” that you applied in step 3. Press save after you set up.



### **STEP 5 : IP SETTING**

In the DVR MENU / NETWORK set the IP ADDRESS, GATEWAY, NET MASK, DNS and WEB PORT.

Below is an example of the settings required:

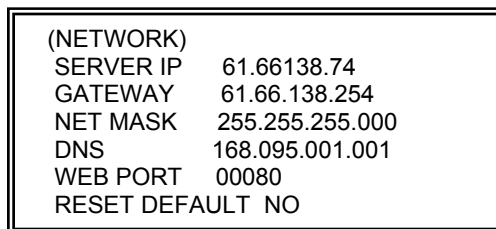

### **STEP 6 : Connect Router**

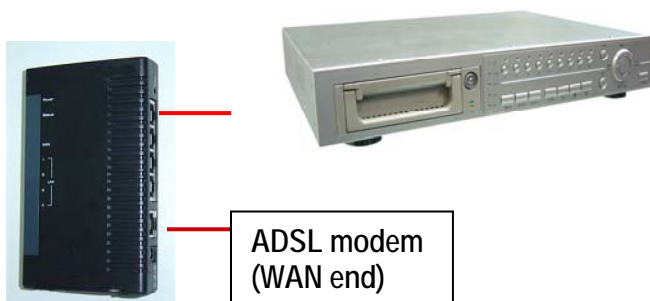

### **STEP 7 : Connect to the DVR via the Internet**

1. Change PC network setting to the original setting and link PC to the internet.
2. Click  twice and enter your User name, Password and host on the Video Web Server. (Note: If you did not change the "Account" , the User Name and Password are both "admin".) Click OK to connect.

Example:

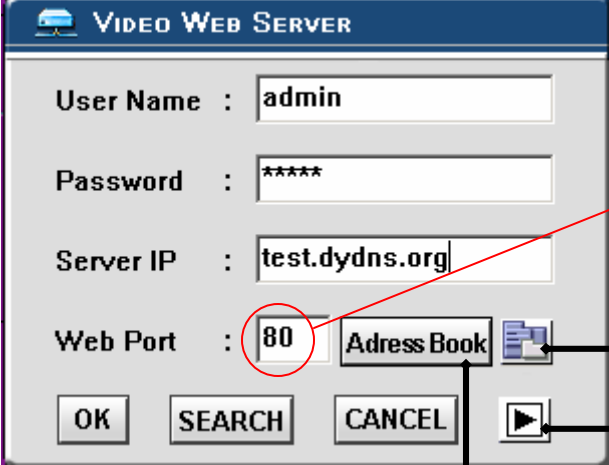

The screenshot shows the VIDEO WEB SERVER interface with the following fields and buttons:

- User Name : admin
- Password : \*\*\*\*\*
- Server IP : test.dydns.org
- Web Port : 80 (circled in red)
- Buttons: OK, SEARCH, CANCEL, Address Book (with folder icon), Backup Program (with floppy icon), Play the last record file (with play icon)

A red box highlights the Web Port field with the following text:

The default value for the web port is 80. If you change this port you will also need to make the same change in the software, and also in the Internet Explorer Address. For example , if you change this port to 2000 then the IP Address would be 61.62.147.111:2000

Arrows point from the Address Book button to the Backup Program and Play the last record file buttons.

User	IP Address
mark	61.62.147.111

There are two ways to get the software: one is via the attached CD, and the other is via the Video Web Server.

#### **Address Book**

You can press the "Address Book" button to add a new IP or choose any login IP address to access the Video Server. This function is designed to store a list of IP addresses which you can control and manage.

#### **Backup Program**

You can press " " button and backup all related files of this application program to any storage device that you want (for example: any hard disk or USB Flash Drive).

#### **Play last record file**

You can press " " button and you can play the last recorded file.

## Software Operation at the Remote Site

Follow the steps below to connect to a remote site. (e.g. If you set up the server at your office with one static ADSL, you can remotely watch the video anywhere, with a networkable computer.)

Step 1: Click  twice to enter the Login setup (please refer to “software installation”).

Step 2: Key in “User Name” and “Password”. Click “OK” to establish the connection.

Example:



The screenshot shows a dialog box titled "VIDEO WEB SERVER". It contains the following fields and controls:

- User Name :**
- Password :**
- Server IP :**
- Web Port :**   
- Buttons:    

Step 3: If you see the video screen, then you have successfully connecting to the server.



## Control Panel and Basic Operation

### A. Video Web Server control panel

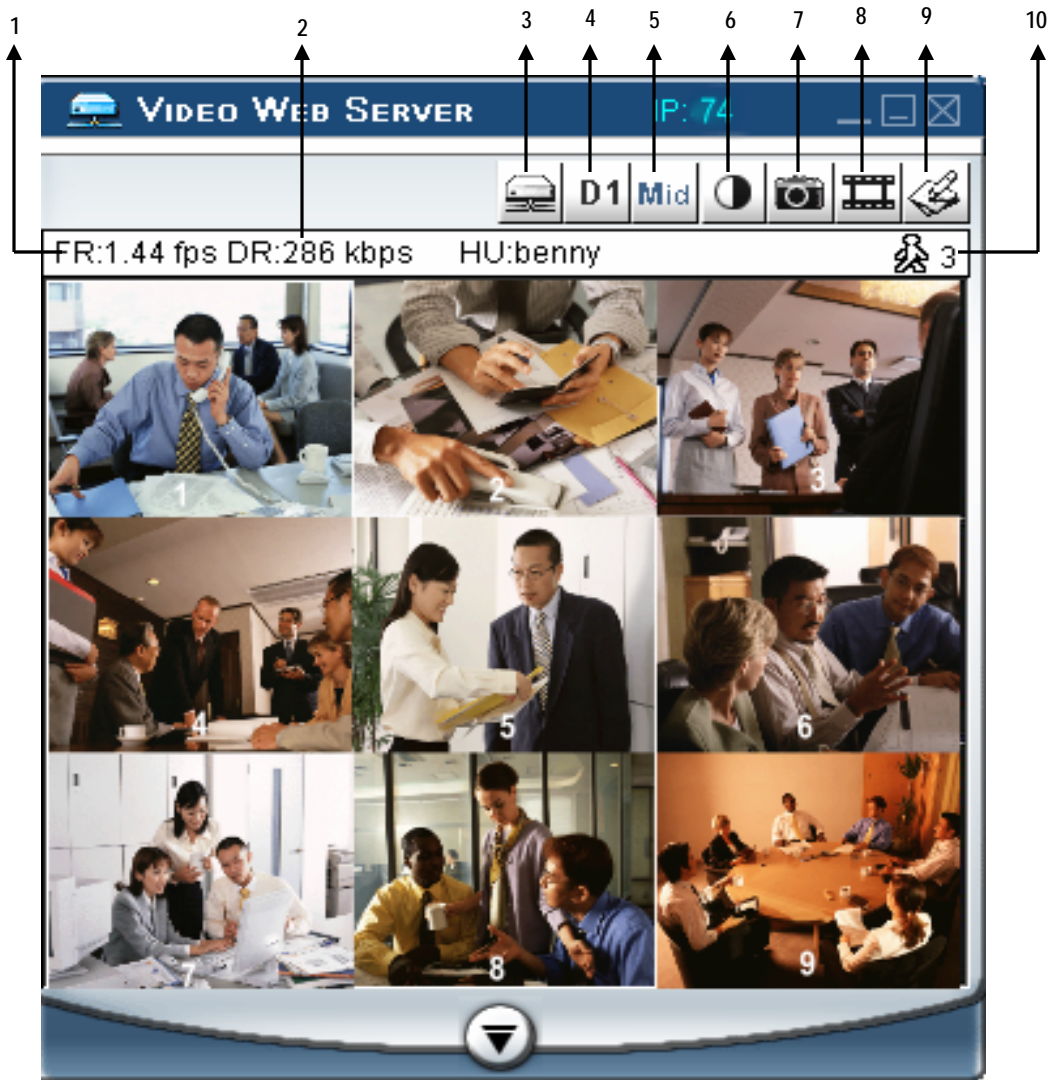

1. Image transmission rate per second.
2. Data transmission rate.
3. Connection/Disconnection.
4. Resolution: D1, CIF
5. Image quality: High, Middle, Low.
6. Image adjusting: Brightness/ Contrast/ Saturation.
7. Snapshot: press this button, to automatically save the image on your PC.
8. Record: press this button to record the files and automatically save them on your PC.
9. System Configuration.
10. Number of online users.

## B. Digital device control panel

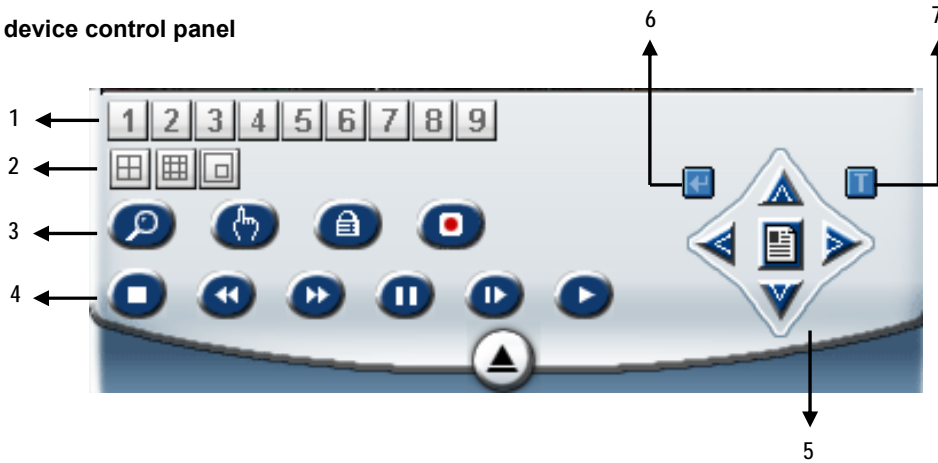

1. CH1-9
2. 4cut, 7cut, 9cut, PIP
3. Zoom, Select, Lock, Record
4. Stop, Rewind, Fast Forward, Pause, Slow, Play
5. Menu (Exit), Left, Right, Up, Down
6. Enter
7. TURBO\*

### \*TURBO:

Activate the turbo button when you would like to shift the selection more quickly by jumping 6 selections at a time.

### NOTE:

After you press the record icon, there will be a recorded file on your PC. Each recording file can save up to 6000 frames. The recording file will be assigned to the second file if it is more than 6000 frames. If the HDD space is less than 200MB, the program will stop recording.

## Play Back Operation

You will find the recorded file on the PC. Click twice to playback.



1. On Screen Display
2. Snapshot
3. Stop
4. Pause
5. Slow (1/2X, 1/4X, 1/8X, 1/16X, 1/32X)
6. PLAY
7. Fast (2X, 4X, 8X, 16X, 32X)
8. OSD show / hide
9. System setting (Path of snapshot, text color, progress color, channel color)
10. Last Video
11. Next Video
12. Duration time / Status
13. Playback controlling bar



## Advanced Settings

Click on “System Config” for advanced setting.

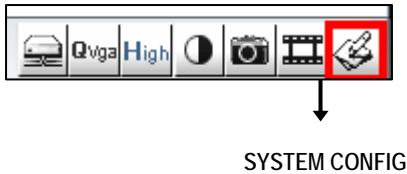

### NOTE :

#### Apply--

After changing all setting, press “apply” to refresh the data.

#### Reboot--

Press this button to restart setting.

## ACCOUNT

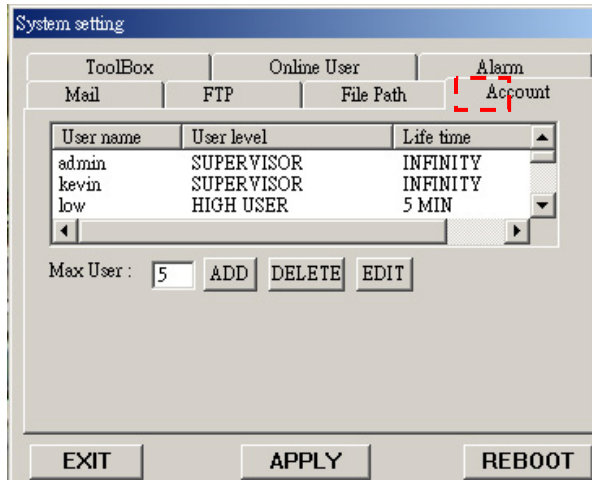

Set up the user's account (Max 10 accounts), password and authority (Max 5 accounts on line at the same time).

### 1. User's level:

**SUPERVISOR**- controls all the functions

**HIGH LEVEL**-controls advanced functions

**NORMAL** -controls basic functions only

**GUEST LEVEL** - watch the image only

2. **Life time**: During this period of time, users are allowed to control the Video Web Server.

## ALARM

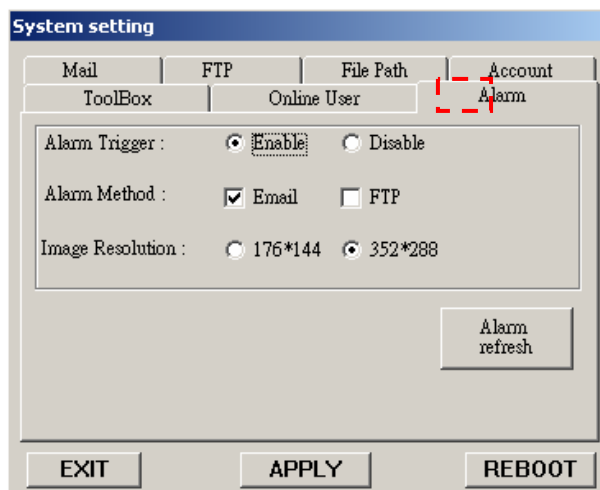

Set up the ALARM function. You can use it to operate the “alarm trigger recording” function.

1. **Alarm Trigger**: Enable or disable Alarm trigger function.

2. **Alarm Method** : Two selections—E-mail or FTP.

3. **Image Resolution** : Image storing resolution for Email or FTP function(CIF is 176 \*144; D1 is 352\*288)

4. **Alarm refresh** : Clear the alarm message “”, which is showed on the screen.

\* When the motion detection is triggered, the DVR will send the alarm image to notify the users.

## MAIL

The screenshot shows the 'System setting' window with the 'Mail' tab selected. The 'ToolBox' menu is open, and 'Mail' is highlighted. The 'Mail' section contains fields for 'Server', 'Mail from', and 'Verify Password' (with 'Yes' and 'No' radio buttons). There are also fields for 'User' and 'Password'. Below these are 'ADD', 'DELETE', and 'EDIT' buttons for 'Modify alarm email address'. At the bottom are 'EXIT', 'APPLY', and 'REBOOT' buttons.

When the alarm is triggered, the video server program will capture the instant picture and e-mail the captured image to the assigned recipients.

1. Get all the data from the ISP company or by mailing it to the server supplier. (POP3/SMTP server)
2. Set the mail list which you want to send to when the alarm is triggered.
3. If it is not necessary for you to verify the password and user's name, please choose Verify as "No".

## FTP

The screenshot shows the 'System setting' window with the 'FTP' tab selected. The 'ToolBox' menu is open, and 'FTP' is highlighted. The 'FTP' section contains fields for 'UserName', 'Password', 'Port' (set to 21), 'Server', and 'Directory'. At the bottom are 'EXIT', 'APPLY', and 'REBOOT' buttons.

When the alarm is triggered, the video server program will capture the instant picture and upload the captured image to the assigned FTP site.

1. Get all the data from the ISP company.
2. The default uploading port is No.21.
3. Set the uploading directory.

## FILE PATH

The screenshot shows the 'System setting' window with the 'File Path' tab selected. The 'ToolBox' menu is open, and 'File Path' is highlighted. The 'File Path' section contains fields for 'Record Path' and 'Snapshot Path', both with 'Modify' buttons. The paths shown are 'C:\Documents and Settings\bowbow.huang\桌面\'. At the bottom are 'EXIT', 'APPLY', and 'REBOOT' buttons.

You can modify the storing path for the recording file and snapshot images.

## TOOL BOX

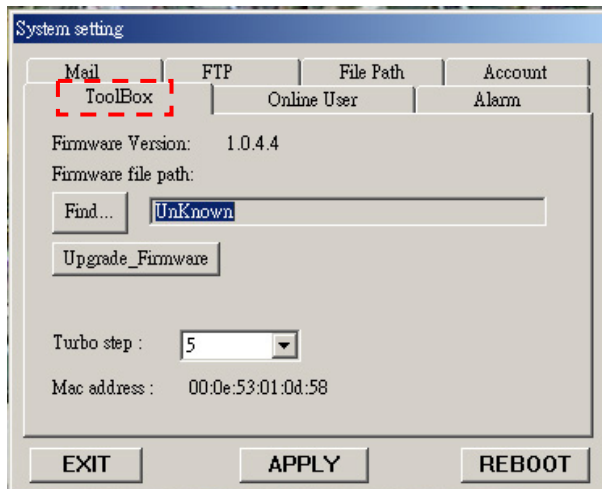

Upgrade the firmware and get the online users' information.

**NOTE:** Do not reboot the DVR while it is upgrading the firmware.

- 1. Firmware Version:** For the current firmware version, you can click on the "Find" button to get the latest firmware from your PC. Press "Upgrade Firmware" to upgrade it.
- 2. Turbo step:** Activate the turbo button when you would like to shift the selection by jumping 6 selections at a time.

## ONLINE USER

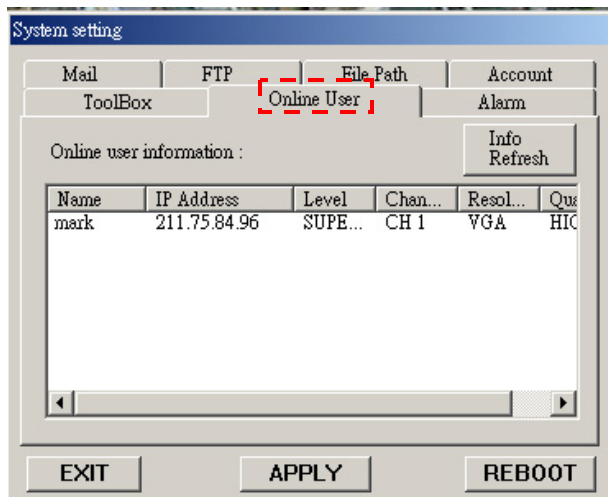

Get online users information

- 1. Info refresh:** Refresh the online users information

## Connecting the Video Web Server Via the Internet Explorer Browser

You can also connect to the Video Web Server via the Internet Explorer browser. This function is suitable for both WIN 2000 and WIN XP (WIN XP is preferable over WIN 2000).

**Step 1:** Enter the IP address that you want to connect to. (see example below)

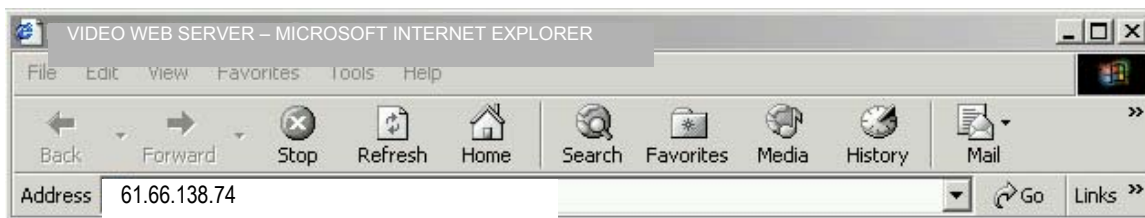



Step 2: Enter your Username and Password to login to the Video Web Server.



**Note:** If you would like to download the Video Web Server Application you can do this by clicking this button and saving the file to your remote computer, and installing it.

Step 3: Click on "YES" to confirm that the Download Application is authentic and has been verified.

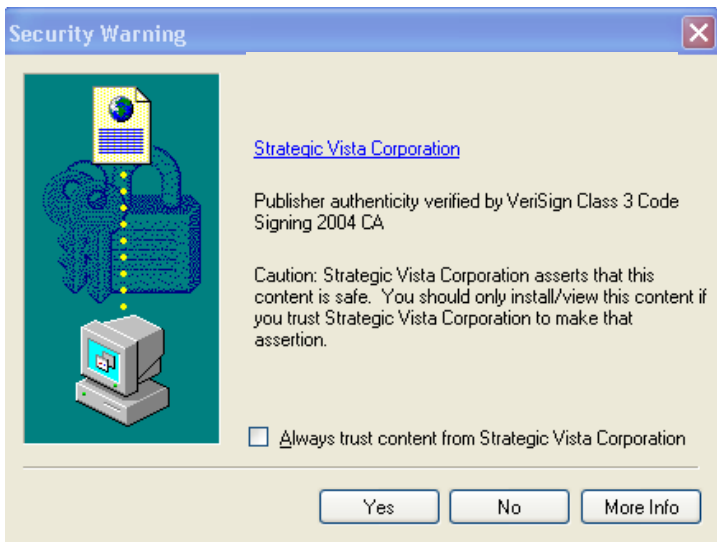

Step 4: After you login, you will see the Video Web Server screen (example below).

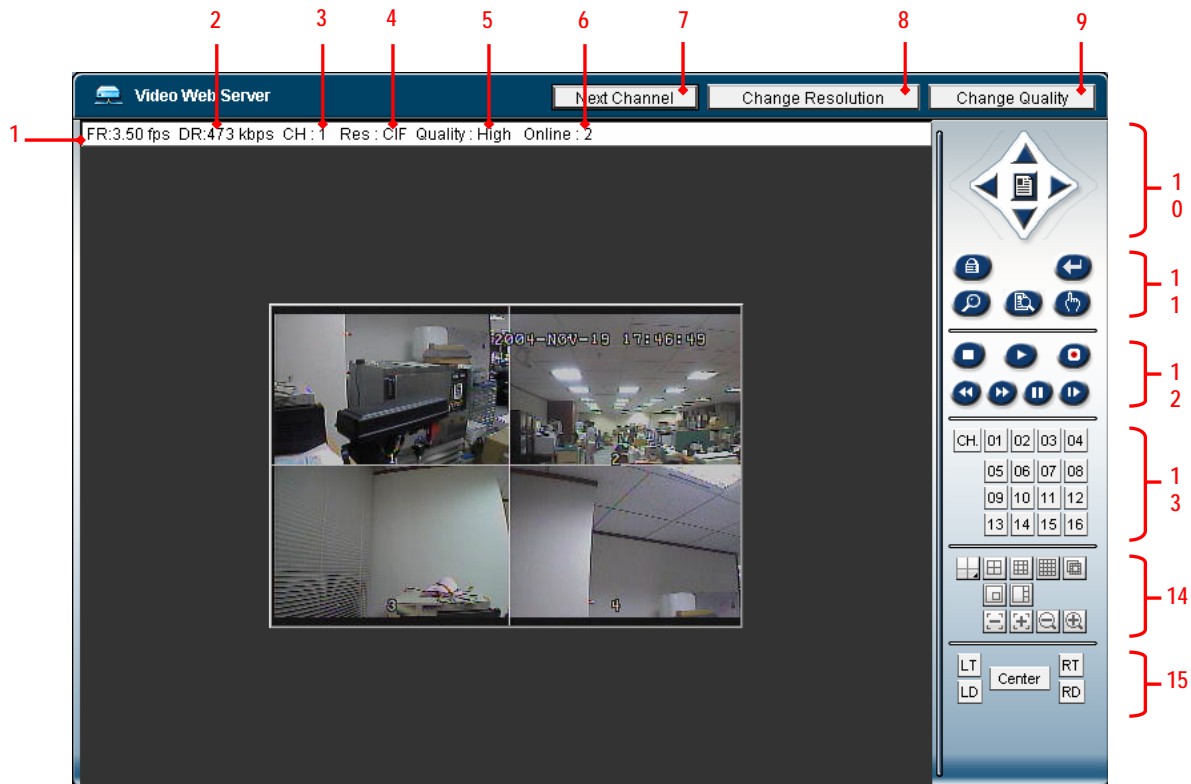

- |                                       |   |
|---------------------------------------|---|
| 1. Image transmission rate per second | 9. Quality switching button                     |
| 2. Data transmission rate             | 10. Menu, Left, Right, Up, Down, Exit           |
| 3. Video Channel                      | 11. Lock, Enter, Zoom, Search, Select.          |
| 4. Resolution: D1, CIF                | 12. Stop, Play, Record, Rew, Fast, Pause, Slow, |
| 5. Image quality: High, Middle, Low   | 13. Camera                                      |
| 6. Number of online users             | 14. 4cut, 7cut, 9cut, PIP                       |
| 7. Channel switching button           | 15. Position of view                            |
| 8. Resolution switching button        |   |

## Key Lock

For added security, you can Lock the buttons on your DXR209. Locking disables the functionality of the buttons and prevents accidental key presses from altering the operation of the DXR209.

To **enable** the Key Lock feature, press and hold the **ENTER** and **MENU** keys at the same time.

To **disable** the Key Lock feature when it is locked, press the **ENTER** and **MENU** keys at the same time, key in the password (Default : 0000) and press the **ENTER** key again.

## Troubleshooting

PROBLEM	SOLUTION
HDD not found	Need to insert HDD. Make sure that the HDD Cartridge is locked, then press any key to continue.
No Power	Check the power source cord connections. Check that there is power at the outlet.
Buttons aren't working when pressed	Check if the system is in Key Lock mode. Press <b>MENU</b> and <b>ENTER</b> at the same time and enter password to escape the Key Lock mode.
No recorded video	Check that the HDD has been installed correctly.
Timer / Alarm recording isn't working	Check that Timer / Alarm Enable is set to YES.
No video	Check camera's video cables and connections. Check monitor's video cables and connections. Make sure that the camera is receiving power.

## Technical Specifications

Video format	NTSC/EIA or PAL/CCIR
Network Interface	Ethernet (10100 Base-T)
Protocols	TCPIP, ICMP, SMTP, HTTP, FTP
Triggers & Actions	E-mail images or images uploaded to FTP site / Remote recording
HDD storage	IDE type, UDMA 66 above, 1 removable HDD supported
Record mode	Manual / Alarm / Timer/Motion Trigger
Camera input signal	Composite video signal 1 Vp-p 75Ω BNC, 9 Channels
Camera loop back	Composite video signal 1 Vp-p 75Ω BNC, 9 Channels
Main monitor output	Composite video signal 1 Vp-p 75Ω BNC
Call monitor output	Composite video signal 1 Vp-p 75Ω BNC
Audio input/ output	4 audio inputs, (RCA) and 2 audio outputs, (RCA)
Motion detect area	15 X 12 Targets per camera (NTSC)/ 15*14 targets per camera (PAL)
Motion detect sensitivity	256 Levels
Video loss detection	Yes
Refresh rate	72 IPS for NTSC / 100 IPS for PAL
Recording rate	25 IPS for NTSC / 12 IPS for PAL
Dwell time	Programmable (1 - 10 Sec)
Picture in picture	Yes (Moveable)
Key lock	Yes
Picture zoom	2X (Moveable)
Camera title	6 Characters
Video adjustable	Color / Contrast / Brightness Adjustable
Alarm input / output	Input: TTL input, Hi (5V), Low (GND) Output: COM,/N.O/N.C
Time display format	YY/MM/DD, DD/MM/YY, MM/DD/YY, OFF
Power source	AC 100-240V +/- 10% switching adaptor
Power consumption	<32W
Operation temperature	10 - 40 degrees C
Dimension (mm)	430 (W) x 65 (H) x 300 (D)
Net weight	5.4 Kgs

## Appendix 1: Installing the HDD

**NOTE:** The HDD has the same purpose in a DXR209 as a videocassette does in a VCR. However, installing the HDD is a bit more complicated. Please follow the next steps carefully in order to ensure proper installation.

The compartment (with the handle) located on the front panel of the DXR209 is the removable Cartridge Casing where the HDD is inserted. The various parts of the Cartridge Casing are labeled for your reference.

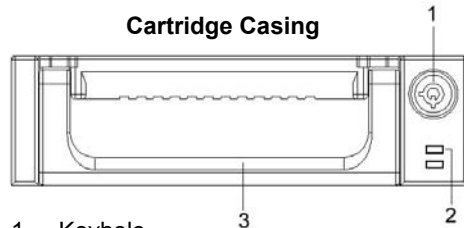

1. Keyhole
2. LED indicator lights (Power indicator & HDD Access indicator)
3. Handle

### Step 1: Remove the Cartridge Casing from the DXR209.

Lift the handle and pull towards you. The Cartridge Casing will slide out of the DXR209.

**NOTE:** The Cartridge must be unlocked to remove it, (please see [step 8](#) for more information on locking and unlocking the removable HDD cartridge).

### Step 2: Remove the Cover from the Cartridge Casing.

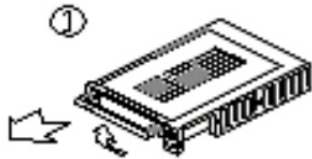

**Step 3: Unclip the release latch with the word "OPEN," printed beside it by gently pushing on the latch.**

**Step 4: Slide the cover off the Cartridge Casing.**

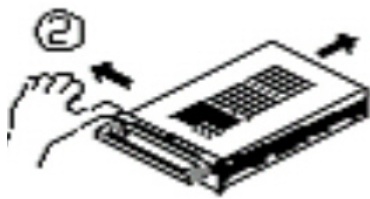

**Step 5: Insert the HDD into the Cartridge Casing.**

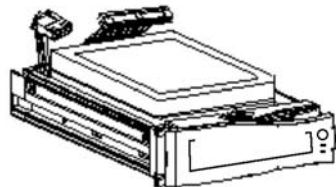

Take the Hard Disk Drive and connect the two cables from the back of the Cartridge Casing to the HDD.

The cables should be pushed in firmly, but not forcibly.

**Step 6: Secure the HDD in the Cartridge Casing.**

Position the HDD into place and secure it using the six screws supplied.

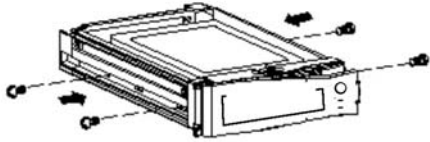

**Step 7: Slide the top Cover over the Cartridge Casing.**

Slide the Cover forward over the Cartridge Case. Ensure it is secured in place over the release latch.

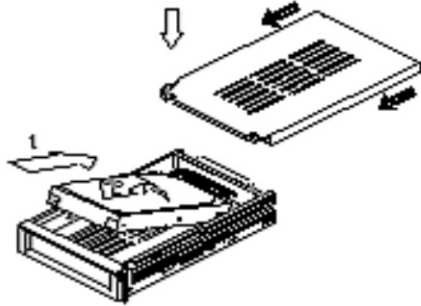

Reinsert the Cartridge Casing into the DXR209

**Step 8: Lock the Cartridge**

To Lock the cabinet, turn the key clockwise to Position A.

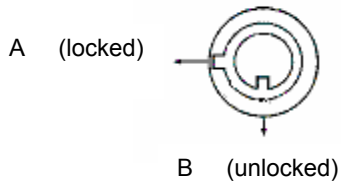

To unlock the cabinet, turn the key counter-clockwise to Position B.

**NOTE:** The DXR209 will not function if the key is not in the locked position.

1. The HDD should be selected as "Master".
2. This product does not support hot swap. Please power off the unit before removing HDD.
3. Approved models and manufactures of HDD are listed in Appendix #6 and have been tested and proven compatible with this DVR.
4. Please remove hard disk drive ONLY after power is shut off for more than 60 seconds. This would protect and extend the operating life of the hard disk drive.
5. HDD should be set up by selecting HDD Jumper.

## Appendix 2: Connection Diagram to Cameras and Monitor

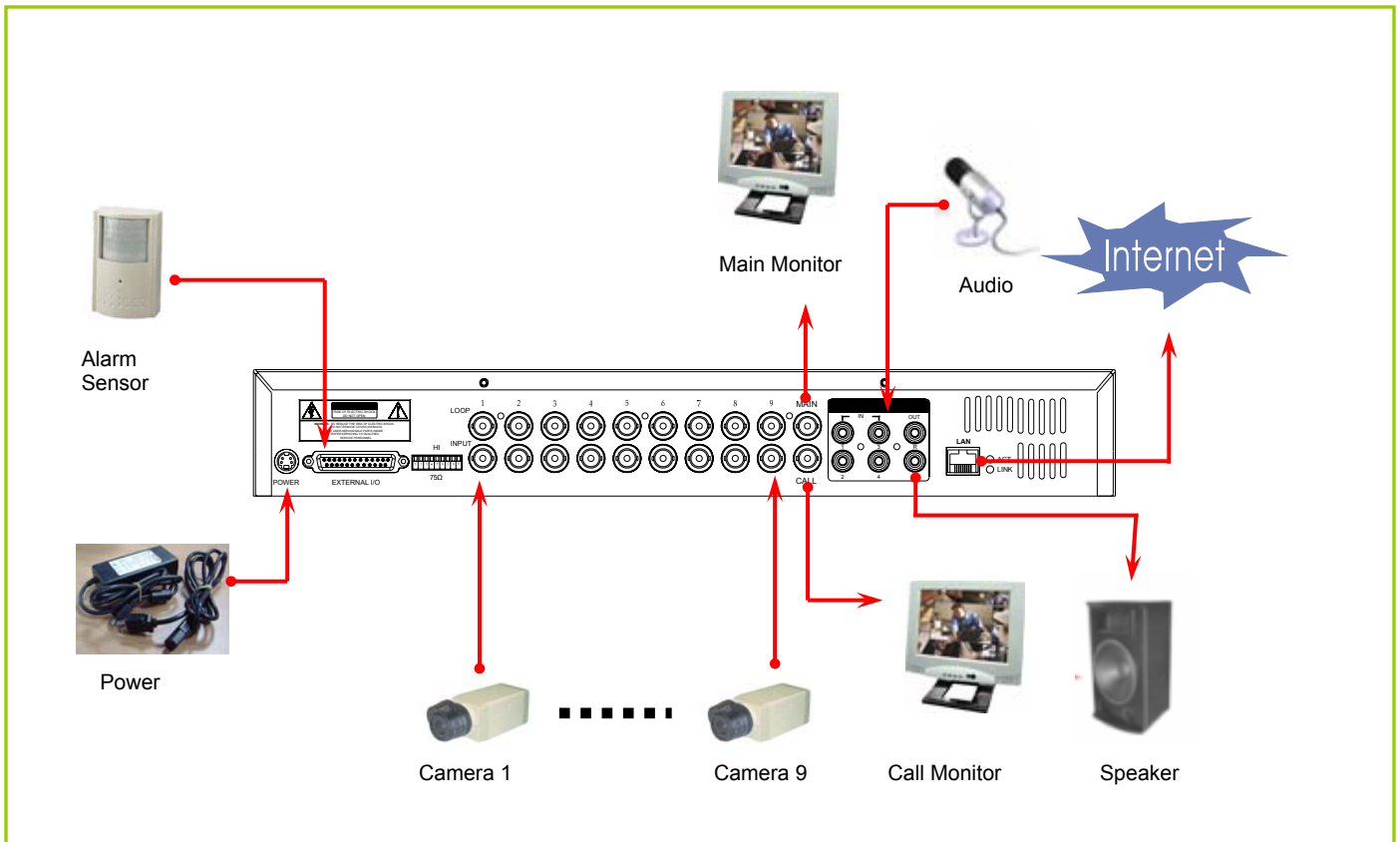

## Appendix 3: Pin Configurations

### 25 Pin Com Port

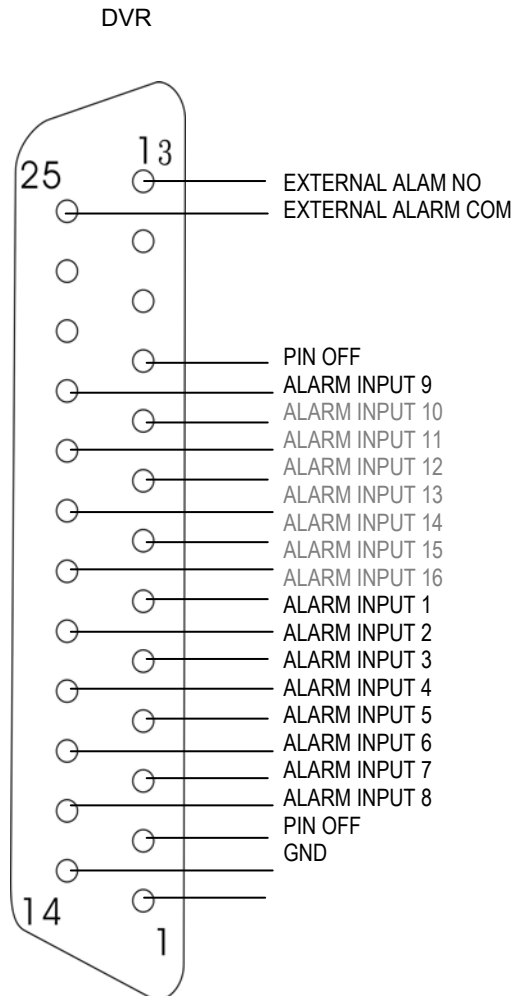

GND	GROUND	PIN 1
<b>ALARM INPUT</b>	To connect wire from ALARM INPUT ( <b>PIN 2 -- 9; PIN 15-22</b> ) to GND ( <b>PIN 1</b> ) connector, DVR will start recording and buzzer will sound. > When Menu / Camera / Alarm is set to "Low": the unit starts to record and the buzzer sounds. > When Menu / Camera / Alarm is set up to "High": the unit starts to record and the buzzer sounds.	<b>PIN 2-9; PIN 15-22</b>
<b>PIN OFF</b>	----	<b>PIN 10,14</b>
<b>EXTERNAL ALARM NO</b>	Under normal operations COM disconnects with NO. When the Alarm is triggered, COM connects with NO.	<b>PIN13</b>
<b>EXTERNAL ALARM COM</b>	Under normal operations COM disconnects with NO. When the Alarm is triggered, COM connects with NO.	<b>PIN 25</b>



## Appendix 4: Rack Mount Installation

Screws and brackets for rack mounting applications can be purchased as an optional accessory.

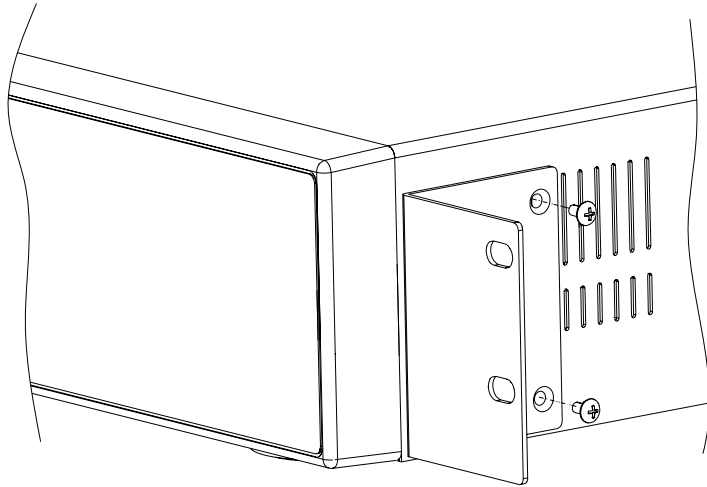

Front Angle with Rack Mount (Optional)

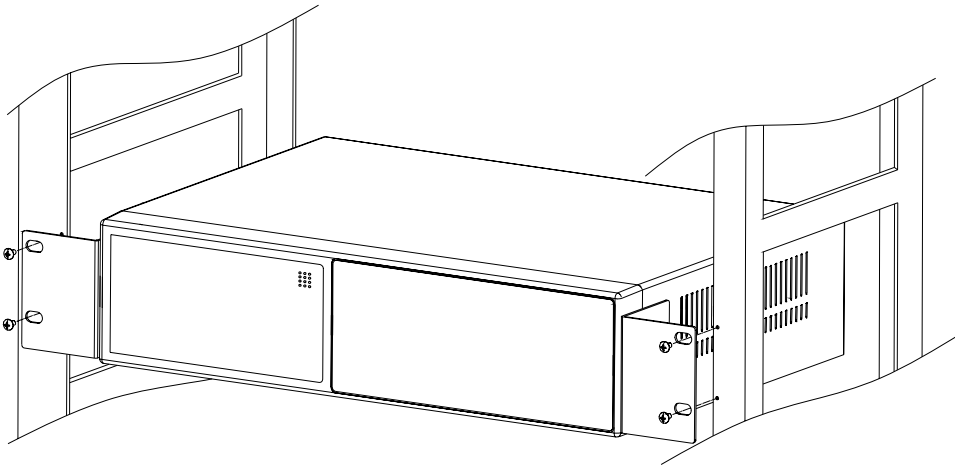

Side View with Rack Mount (Optional)

For more information about the rack mount & other accessories through Lorex, please visit: [www.Lorexctv.com](http://www.Lorexctv.com).

## Appendix 5: Recording Times (in Hours)

### NTSC SYSTEM

IPS		25A	15	8	4	2	1
Record Quality	Best	16hr	32hr	60hr	120hr	240hr	480hr
	High	20hr	40hr	75hr	150hr	300hr	600hr
	Normal	32hr	64hr	120hr	240hr	480hr	960hr
	Basic	54hr	105hr	200hr	400hr	800hr	1600hr
HDD Type		80GB					

IPS		25A	15	8	4	2	1
Record Quality	Best	24hr	48hr	90hr	180hr	360hr	720hr
	High	30hr	60hr	1136hr	225hr	450hr	900hr
	Normal	48hr	96hr	1600hr	360hr	720hr	1440hr
	Basic	80hr	160hr	300hr	600hr	1200hr	2400hr
HDD Type		120GB					

IPS		25A	15	8	4	2	1
Record Quality	Best	32hr	64hr	120hr	240hr	480hr	960hr
	High	40hr	80hr	150hr	300hr	600hr	1200hr
	Normal	64hr	128hr	240hr	480hr	960hr	1920hr
	Basic	108hr	210hr	400hr	800hr	1600hr	3200hr
HDD Type		160GB					

**NOTE:** The above data has been taken from actual test data obtained using recordings from a normal TV program and is to be used for reference purposes only.

## Appendix 6: Compatible HDD Brands

Manufacturer	Model	Capacity	Rotation
HITACHI	Deskstar 180 GXP (120 GB)	120GB	7200 rpm
HITACHI	Deskstar 7K250, HDS722516VLAT20	160GB	7200rpm
HITACHI	Deskstar 7K250, HDS722525VLAT80	250GB	7200rpm
IBM	Deskstar 120GXP (80GB)	80GB	7200 rpm
IBM	Deskstar 120GXP (120GB)	120GB	7200 rpm
Maxtor	DiamondMax 536DX(60GB) 4W060H4	60GB	5400rpm
Maxtor	DiamondMax Plus 9	80GB	7200 rpm
Maxtor	DiamondMax Plus 9, Model#6Y120L	120GB	7200 rpm
Maxtor	DiamondMax Plus 9, Model#6Y160L0	160GB	7200rpm
Seagate	Barracuda ATA IV, ST380021A	80GB	7200rpm
Seagate	Barracuda ATA V, ST3120023A	120GB	7200 rpm
Seagate	Barracuda 7200.7 Plus, ST3160023A	160GB	7200 rpm
Western Digital	Caviar WD1200BB-00CAA1	120GB	7200rpm
Western Digital	Caviar WD2000BB-00DWA0	200GB	7200rpm

Brand	Capacity	Capacity after format	Format Time
HITACHI	250GB	217.6GB	9' 48"
HITACHI	160GB	142.5GB	6' 02"
HITACHI	80GB	70.8GB	4' 08"
HITACHI	40GB	35.0GB	3' 30"
SEAGATE	200GB	173.2GB	8' 23"
SEAGATE	160GB	138.4GB	7' 23"
MAXTOR	250GB	217.6GB	10' 12"
W. D.	250GB	216.8GB	10' 02"
W. D.	40GB	34.0GB	3' 30"

Note: The above brands and models of HDD have been tested and they are compatible with the DXR209.

# It's all on the web



Product Information



Specification Sheets



User Manuals



Software Upgrades



Quick Start Guides



Firmware Upgrades



VISIT  
[www.lorexcctv.com](http://www.lorexcctv.com)

[www.lorexcctv.com](http://www.lorexcctv.com)

Strategic Vista International Inc.

## Free Manuals Download Website

<http://myh66.com>

<http://usermanuals.us>

<http://www.somanuals.com>

<http://www.4manuals.cc>

<http://www.manual-lib.com>

<http://www.404manual.com>

<http://www.luxmanual.com>

<http://aubethermostatmanual.com>

Golf course search by state

<http://golfingnear.com>

Email search by domain

<http://emailbydomain.com>

Auto manuals search

<http://auto.somanuals.com>

TV manuals search

<http://tv.somanuals.com>