

INSTRUCTION MANUAL



9 Channel Digital Video Recorder

DXR109



**FOR MORE INFORMATION
WWW.STRATEGICVISTA.COM**

**BEFORE OPERATING THIS SYSTEM, PLEASE READ THIS MANUAL THOROUGHLY AND
RETAIN IT FOR FUTURE REFERENCE**

Under the copyright laws, this documentation may not be copied, photocopied, reproduced, translated, or reduced to any electronic medium or machine-readable form, in whole or part without the prior written consent of Strategic Vista Technologies Inc., except in the manner described in the documentation.

© Copyright 2003

Strategic Vista
300 Alden Road
Markham, Ontario
L3R 4C1 CANADA

All rights reserved. Printed in Taiwan.

THIS DEVICE COMPLIES WITH PART 15 OF THE FCC RULES.
OPERATION IS SUBJECT TO THE FOLLOWING TWO CONDITIONS:

1. THIS DEVICE MAY NOT CAUSE HARMFULL INTERFERENCE, AND
2. THIS DEVICE MUST ACCEPT ANY INTERFERENCE RECEIVED, INCLUDING INTERFERENCE THAT MAY CAUSE UNDESIREED OPERATION.

NOTE: This equipment has been tested and found to comply with the limits for a Class B digital device, pursuant to part 15 of the FCC Rules. These limits are designed to provide reasonable protection against harmful interference when the equipment is operated in a commercial environment. This equipment generates, uses, and can radiate radio frequency energy and, if not installed and used in accordance with the instruction manual, may cause harmful interference to radio communications. However, there is no guarantee that interference will not occur in a particular installation. Operation of this equipment in a residential area is likely to cause harmful interference in which case the user will be required to correct the interference at one's own expense.

CAUTION: CHANGES OR MODIFICATIONS NOT EXPRESSLY APPROVED BY THE PARTY RESPONSIBLE FOR COMPLIANCE COULD VOID THE USER'S AUTHORITY TO OPERATE THE EQUIPMENT.

Table of Contents

Important Safety Instructions.....	3
Introduction.....	4
Features.....	4
System Contents.....	5
Getting Started.....	5
Front Panel Controls.....	6
Back Panel Connections.....	8
Accessing the Main Menu.....	9
Main Menu.....	9
System Set Up.....	10
Selecting the Audio Input Channel.....	10
Setting the Internal Audible Alarm Buzzer.....	10
Setting the External Audible Alarm device.....	10
Setting the Motion Audible Alarm feature.....	11
Setting the Alarm Duration.....	11
Setting the Dwell Time.....	11
Setting the Message Latch feature.....	11
System Time/Date Set up.....	11
Selecting the Date Display Format.....	11
Setting System Time & Date.....	11
Changing the System Password.....	12
Clearing the Hard Drive Data.....	12
Resetting System to Factory Defaults.....	12
Remote Protocol Setup.....	13
Timer Recording Setup.....	13
Timer.....	13
Record Settings.....	15
HDD Overwrite Setup:.....	15
Record IPS Setup:.....	15
Record Quality Setup.....	15
Alarm REC IPS setup.....	15
Alarm REC Quality setup.....	15
Motion Trigger Record.....	15
Camera Channel Setup.....	16
Motion Detection.....	17
Event Log Viewing.....	19
Operation.....	20
On Screen Display (OSD).....	20
Recording Methods.....	20
Viewing Options:.....	20
Individual Camera Select (1 - 9):.....	20
Multi View Select:.....	20
Picture in Picture (PIP):.....	21
Zoom:.....	21
Video Search.....	21
Playing Back Video.....	21
Key Lock.....	22
Troubleshooting.....	23
Technical Specifications.....	24
Appendix 1: Installing the HDD.....	25
Appendix 2: Connection Diagram to Cameras and Monitor.....	27
Appendix 3: Pin Configurations.....	28
Pin References for RS-232 / Alarm Block.....	29
Appendix 4: Rack Mount Installation.....	30
Appendix 5: Recording Times (in Hours).....	31
Appendix 6: RS232 Remote Protocol.....	32
Appendix 7: Compatible HDD Brands.....	33
Limited Warranty.....	34
Care & Maintenance.....	35

Important Safety Instructions

All the safety and operating instructions should be read before operating this equipment. The improper operation may cause irreparable damage to the appliance.

Lift and place this equipment gently.

Do not expose this equipment to direct sunlight.

Do not use this equipment near water or in contact with water.

Do not spill liquid of any kind on the equipment.

Do not unplug the power connector before turning the power off correctly.

This equipment should be operated using only the power source from standard package.

Unauthorized repair or parts substitutions may result in fire, electric shock or other hazards.

Do not switch the Power On & Off within short period (within 3 seconds).

Do not attempt to service this equipment by yourself. Refer all servicing to qualified service personnel.

This installation should conform to all local codes.

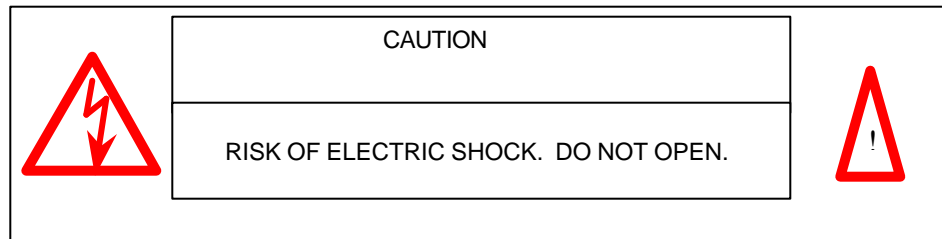

CAUTION: TO REDUCE THE RISK OF ELECTRIC SHOCK, DO NOT REMOVE COVER (OR BACK). NO USER-SERVICEABLE PARTS INSIDE. REFER SERVICING TO QUALIFIED SERVICE PERSONNEL.

Introduction

The DXR109 combines a 9 channel multiplexer with a Digital Video Recorder (DVR).

The DVR offers many advantages over traditional time lapse VCR's, allowing you to quickly access and search for a specific time segment or event, which has been recorded. This high quality recorded video can be viewed at various playback speeds as well as frame-by-frame with the Jog Button feature

To learn more about StrategicVista products, please visit our website at www.strategicvista.com

Features

- Wavelet Compression Format
- 4 Audio inputs and 2 outputs
- Resolution: 704X564 - full screen, 352X282 - 4 channels, 224X188 9 - channels
- Independent main and call monitor outputs allow simultaneous or full screen viewing
- Multi screen display mode
- 9 channel alarm input, alarm display and 1 alarm output
- Video loss detection able to record 160 events on each channel
- Power-loss memory feature (In case of power failure, set-up parameter will remain)
- Supports 1 removable HDD, IDE type (up to a maximum of 250GB)
- Display refresh rate up to 72 IPS (NTSC) and 50 IPS(PAL)
- Record refresh rate up to 25 IPS (NTSC) and 22 IPS (PAL)
- Quick multiple search by date/time, alarm or full list
- Multiple speed playback
- Security password protection
- RS-232, RS-485 communication protocol

System Contents

The DXR109 box should include the items listed below. Please take a moment to verify that no items are missing from the package.



DXR109 Digital Video Recorder



Hard Disk Drive in Cartridge
(not included in all models)



Installation / User Manual



2 Keys for
Hard Drive Cartridge



Power Adapter and Cord

NOTE: KEEP THE KEYS IN A SAFE PLACE. THEY ARE NECESSARY FOR INSTALLATION / REMOVAL OF THE HARD DISK DRIVE.

Getting Started

If the purchased DVR model did not contain a hard disk drive, please refer to [Appendix #1](#) for HDD installation instructions.

1. Connect video sources and monitor(s) following the configuration example shown in [Appendix # 2](#).
2. Connect the AC Power Cord to the Power Adapter and plug into an electrical outlet. A Red LED indicator light will be ON to indicate that the DVR is in Standby mode.
3. Press the Power button. The POWER LED will turn from red to orange, and other red LED indicators will turn ON. Note: the system takes approximately 5 to 15 seconds to power up. During the power-up, you will see the following messages: "HDD Detecting", followed by "Master HDD Connected".

Once connected, the POWER LED will change to green, and the red indicator lights will be ON next to the Alarm and Timer buttons. (The alarm and Timer LED's simply indicate that these features are enabled)

NOTE: IF YOU GET THE MESSAGE "HDD NOT FOUND", PLEASE SEE APPENDIX #1 AS THE HDD IS LIKELY NOT INSTALLED CORRECTLY.

Front Panel Controls

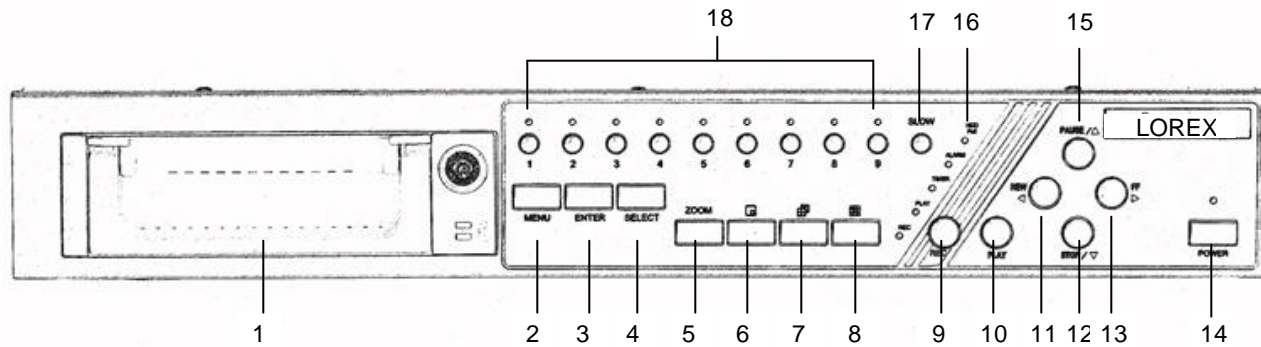

1. **REMOVABLE HDD CARTRIDGE**
Please refer to Appendix #1.
2. **MENU**
Press MENU to enter or exit the system setup menu.
3. **ENTER**
Press ENTER to select an item for change while in the setup menu.
4. **SELECT**
Press the SELECT button to change the camera shown in the individual panes of the multi screen modes.
5. **ZOOM**
Press ZOOM to enlarge the picture display 2x.
6. **Picture in Picture**
Press the PIP button to change to Picture in Picture mode.
7. **4/7 channel display mode**
8. **9 channel display mode**
9. **REC**
Press REC to start recording.
10. **PLAY**
Press PLAY to playback the most recently recorded video.
11. **REW / Left**
REW: Under DMR play mode, it can play video backward at different speeds. (Press REW again to adjust speed as 1, 2, 4, 8, 16, 32 times)
Left: When in the setup mode, it works as Left directional button.
12. **STOP / Down**
 - STOP: Under DMR Record / Play mode, it can stop the moment action.
 - DOWN: When in the setup mode, it works as the Down directional button.
13. **FF / Right**
FF: It can play video forward at high speed, and press FF again to adjust speed from 1, 2, 4, 8, 16, 32 times.
Right: When in the setup mode, it can work as the Right directional button.
14. **POWER**
Press Power to turn ON / OFF the DMR.

15. PAUSE / Up

Pause: Under DMR play mode, it can pause the action.

UP: When in the setup mode, it works as an Up directional button.

16. LED INDICATORS

These LED Light are ON under following condition.

- HDD Full: HDD is full
- ALARM: If you want to turn off the ALARM LED light, please refer to page 13 and set the Camera / ALARM item as OFF (all of the cameras should be set as OFF.)
- TIMER: When Timer is set as Enabled
- PLAY: On Play mode
- REC: On Recording mode

17. SLOW

Press to slow down the playback speed.

18. CAMERA SELECT (1-9)

Press the Camera Select (1-9) to select specified camera

Back Panel Connections

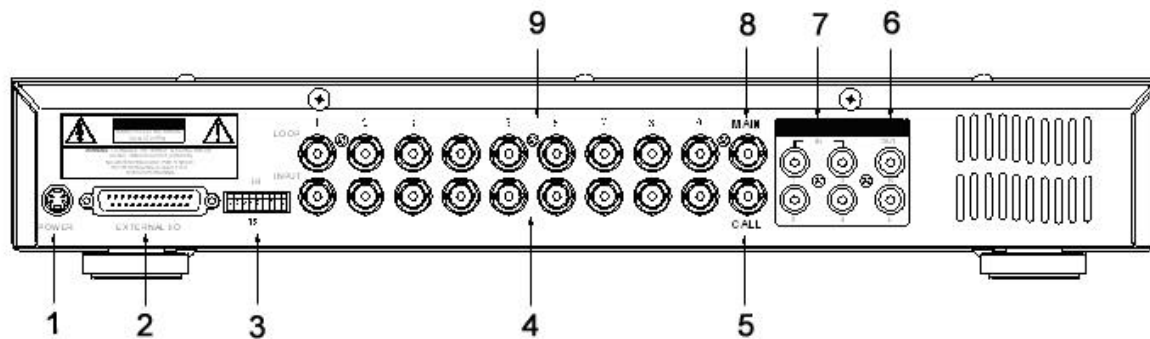

- 1. POWER INPUT**
Connects to the Power cord.
- 2. EXTERNAL I/O**
Connects to a PC for Remote Control via RS-232 or to an Alarm Block. (see appendix 6 for more info)
- 3. 75/HI**
When using the LOOP function, allows for HI impedance or 75ohms.
- 4. VIDEO INPUT (1-9)**
Connects to a video source i.e. (camera).
- 5. CALL**
Connects to the CALL monitor for real time sequencing.
- 6. AUDIO OUTPUTS (1-2)**
Connects to a speaker (or a monitor with audio speaker).
- 7. AUDIO OUTPUTS (R/L)**
Connects to an audio source for recording purposes (i.e. microphone).
- 8. MONITOR**
Connects to the main display monitor.
- 9. LOOP**
Allows connection to other video devices.

Accessing the Main Menu

The Menu allows you to configure your DVR settings and program various recording options. Follow these steps in order to access the Menu:

Press the **MENU** button. The password screen will appear:

Password: 0000

The default Password is 0000.

To change the number of the Password, use the ? / ? buttons to scroll left and right between numbers, and use the ? / ? buttons to change the value of the number that is flashing.

Press the **ENTER** button once the correct Password is entered. The menu options screen will appear.

NOTE: If you get a message "Password Error", you have entered an incorrect password.

Main Menu

When the correct password is entered, the main menu options will be displayed.

There are 5 options available in the Main Menu:

- Timer:** Scheduling Recording
- Record:** Record mode set-up
- Camera:** Camera channel set-up
- System:** System Setup (Sets the date, chooses an HDD overwrite setting, changes password, resets system settings, or clears the HDD)
- Event:** Event List - Allows you to view video from a list of recorded events

(Menu)
?
Search
Timer
Record
Camera
System
Event

Navigating the Menu:

- ? / ? : Scroll up and down through menu options; change values when an option is selected and is blinking
- ? / ? : Scroll sideways within a menu option that has been selected

- ENTER:** Selects a submenu / an option in a submenu for browsing / modification
- MENU:** Completes modification of a menu option; exits a menu

NOTE: The Menu setup will timeout after 1 minute of no key presses.

System Set Up

The system menu is used to configure the system level options of the DXR109...

To access the System features, press **MENU** followed by the 4-digit password. Use the ? / ? to scroll to the 'System' option and press **ENTER**.

(SYSTEM)	
Audio Input:	1
Int Audible Alarm:	ON
Ext Audible Alarm:	ON
Motion Audible Alarm:	ON
Alarm Duration:	10 SEC
Dwell Time:	02 SEC
Message Latch:	NO
Title Display:	ON
Time Display:	Y/M/D
2003-JAN-02 (THU)	17:37:09
New Password:	XXXX
Clear HDD:	NO
System Reset:	NO
Remote Mode:	RS-232
Baud Rate:	9600
Remote ID:	000

Using the ? / ? buttons, scroll to the desired option and press **ENTER** to select it.

Selecting the Audio Input Channel

This Feature is used to select the audio channel to record. To set this Audio Input Channel:

1. On the System screen, press ? / ? to select Audio Input, then press **ENTER**.
2. Press ? / ? to select the desired time audio channel (1-4)
3. Press **MENU** to confirm your change.
4. Press ? / ? to move to another field on the System screen or press **MENU** to exit.

Setting the Internal Audible Alarm Buzzer

To enable or disable the internal audible alarm buzzer: If enabled, the buzzer will sound when the external alarm input is activated.

1. On the System screen, press ? / ? to select Internal audible alarm buzzer, then press **ENTER**.
2. Press ? / ? to enable or disable the internal audible alarm buzzer. Options are:
ON = Buzzer is on. When the DVR detects an alarm, the system sounds the internal buzzer to alert the user.
OFF = Buzzer is off.
3. Press **MENU** to confirm your change.
4. Press ? / ? to move to another field on the System screen or press **MENU** to exit.

Setting the External Audible Alarm device

To enable or disable the External Audible Alarm Device:

1. On the System screen, press ? / ? to select External Audible Alarm Device, then press **ENTER**.
2. Press ? / ? to enable or disable the External Audible Alarm Device. Options are:
ON = External Device is on. When the DVR detects an alarm, the system triggers the external audible alarm.
OFF = External Device is Off
3. Press **MENU** to confirm your change.
4. Press ? / ? to move to another field on the System screen or press **MENU** to exit.

Setting the Motion Audible Alarm feature

If enabled, the buzzer will sound if the video motion detect feature is set and motion is detected.

5. On the System screen, press ? / ? to select Motion Audible Alarm, then press **ENTER**.
6. Press ? / ? to enable or disable the External Audible Alarm Device. Options are:
ON = Buzzer will sound when motion is detected.
OFF = The buzzer will remain silent when motion is detected.
7. Press **MENU** to confirm your change.
8. Press ? / ? to move to another field on the System screen or press **MENU** to exit.

Setting the Alarm Duration

To set the duration of the Alarm:

1. On the System screen, press ? / ? to select Alarm Duration, then press **ENTER**.
2. Press ? / ? to select the desired time (10s, 15s, 20, 30, 1min, 2min, 3min, 5min, 10min, 15min, 30min, always)
3. Press **MENU** to confirm your change.
4. Press ? / ? to move to another field on the System screen or press **MENU** to exit.

Setting the Dwell Time

This timer is used to select the amount of time (between 1-10s) a channel appears on the call monitor before sequencing to the next channel. To Set the Dwell Time:

1. On the System screen, press ? / ? to select Dwell Time, then press **ENTER**.
2. Press ? / ? to select the desired time (1-10s)
3. Press **MENU** to confirm your change.
4. Press ? / ? to move to another field on the System screen or press **MENU** to exit.

Setting the Message Latch feature

This feature determines if the On Screen messages will remain on the screen or disappear after 10s. To set the Message Latch:

1. On the System screen, press ? / ? to select Message Latch, then press **ENTER**.
2. Press ? / ? to enable or disable the Message Latch feature. Options are:
NO = Screen messages will disappear after a 10 sec. (this is the default setting)
YES = On Screen messages will remain on the screen for the duration of the event.
3. Press **MENU** to confirm your change.
4. Press ? / ? to move to another field on the System screen or press **MENU** to exit.

System Time/Date Set up

Selecting the Date Display Format

1. On the System screen, press ? / ? to select Date Display, then press **ENTER**.
2. Press ? / ? to choose a display format. Options are:
Y-M-D = Year - Month - Day
M-D-Y = Month - Day - Year
D-M-Y = Day - Month - Year
Off = The date and time will not show on the screen.
3. Press **MENU** to confirm your change.
4. Press ? / ? to move to another field on the System screen or press **MENU** to exit this screen and confirm the current operation.

Setting System Time & Date

1. On the System screen, press ? / ? to select System Time & Date, then press **ENTER**.
2. Press ? / ? to choose a number, then press ? / ? to move to the next digit:
2003-Jan-01 (Mon) 22:38:29
3. Press **MENU** to confirm your change.
4. Press ? / ? to move to another field on the System screen or press **MENU** to exit this screen and confirm the current operation.

Changing the System Password

1. On the System screen, press ? / ? to select New Password, then press **ENTER**.
2. Press ? / ? to choose a number, then press ? / ? to move to the next digit:
3. Press **MENU** to confirm your change.
4. Press ? / ? move to another field on the System screen or press **MENU** to exit this screen and confirm the current operation.
5. If you have completed all your system configuration changes, press **MENU** again to exit and close menu setup.

Clearing the Hard Drive Data

This option will erase all data from the hard drive.

Ensure that there are no important recordings on the disk before using this option.

1. On the System screen, press ? / ? to select Clear HDD, and then press **ENTER**.
2. Press ? / ? to choose YES to clear the HDD or NO to leave as is.
3. When you choose "Yes" on this option and press **ENTER**, the DVR will prompt:
4. Press ? to confirm clearing, or ? to cancel.
5. Press **MENU** to confirm your change.
6. Press ? / ? to move to another field on the System screen or press **MENU** to exit this screen and confirm the current operation.

All Data in HDD
Will Be Cleared
Are you sure?
(? : No ? : Yes)

NOTE: Clearing the data from the Hard Drive results in permanent, irreversible loss of all video and related data currently stored on the Hard Drive.

Resetting System to Factory Defaults

Using the System Reset option will set all options back to factory default settings. Use the steps below to perform this option.

1. On the System screen, press ? / ? to select **System Reset**, and then press **ENTER**.
2. Press ? / ? to choose:
Yes = Confirm the system reset and load the default settings.
No = Do not reset the system at this time.
3. Press **MENU** to exit this screen and confirm the current operation.
4. If you have completed all your system configuration changes, press **MENU** again to exit and close menu setup.

NOTE: This will not affect the time and date settings.

Remote Protocol Setup

This feature is used to set the basic RS-232/RS-485 protocols to control the DVR remotely from a PC.

Pressing **ENTER** after scrolling to the Remote option will bring up the following menu options:

- (Menu)
- Search
- Timer
- Record
- Alarm
- ? Remote
- System
- Event

Remote mode: Selects whether to use an RS-232 or RS-485 interface.

Baud rate: Selects the baud rate (bps) to be used for the connection.
The available settings are: 115200, 57600, 19200, 9600, 3600, 2400, 1200.

ID: Selects a numerical number representing the DVR being controlled if multiple units are being used.
The available setting are: 000 – 255

The remote connection on the DVR uses 8 data bits, 1 start bit, and 1 stop bit, no Parity.

Below is an example of the data stream with the control codes shown.

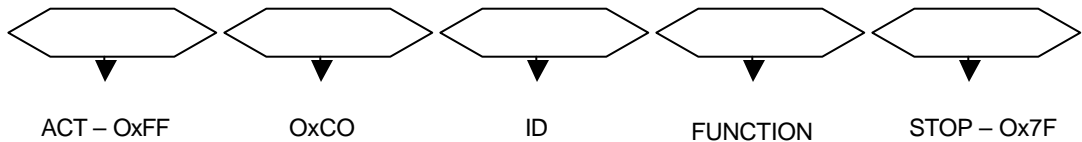

Please refer to [Appendix 3](#) for information on the Pin connections and command protocols that would be used in this application.

Timer Recording Setup

On the Main menu, selecting the Timer option will allow you to set daily schedules in which you would like the DVR to automatically record.

Pressing **ENTER** after scrolling to the Timer option will bring up the following menu options:

- (Menu)
- Search
- ? Timer
- Record
- Alarm
- Remote
- System
- Event

Timer

(Timer)			
Day	Start	End	IPS
Daily	01:00	02:00	Off
SUN	12:00	13:00	Off
MON	08:00	09:00	Off
MO-FR	00:00	01:00	Off
SA-SU	20:00	21:00	Off
JAN-01	15:00	16:00	Off
Timer Enable:	No		

1. Press ? / ? to select the day(s) to record on, the available options are...

- Daily:** Everyday
- SUN:** Sunday
- MON:** Monday
- TUE:** Tuesday
- WED:** Wednesday
- THU:** Thursday
- FRI:** Friday
- SAT:** Saturday
- MO-FR:** Monday to Friday
- SA-SU:** Saturday & Sunday
- JAN-01:** Special Date
- OFF:** Not activated

2. Use the ? / ? scroll keys to move to START record time 00:00 (HH:MM)
Press ? / ? to set the start time
3. Press ? / ? move to END record time 00:00 (HH:MM)
Press ? / ? to change END record Time numerical digit
4. Press ? / ? move to QUALITY
Press ? / ? to choose options of
BEST, HIGH, NORMAL, BASIC
5. Press ? / ? move to Record IPS (Images Per Second)
Press ? / ? to choose one of the following options
NTSC: 15A, 15, 8, 4, 2, 1
PAL: 12A, 12, 6, 3, 2, 1
6. Press **MENU** to confirm current operation, and enter to next Timer Record setup.
7. Press ? / ? move location to Timer Enable: Yes or No setup
YES : To confirm Timer Enable: Scheduling Timer Record feature
NO : To confirm no Timer Enable: No Scheduling Timer Record feature
8. Press **MENU** to exit and confirm current operation.
9. Press **MENU** again to exit and close TIMER setup mode.

NOTE: WHEN THE TIMER IS SET, THE REC LED INDICATOR WILL BE ON. ALTHOUGH THE LIGHT MAY BE ON, THE SYSTEM IS NOT NECESSARILY RECORDING SINCE IT WILL ONLY RECORD DURING ITS SCHEDULED TIME.

Record Settings

On the Main menu, selecting the Record option will allow you to set the quality and speed of recordings.

Pressing **ENTER** after scrolling to the Record option will bring up the following menu options:

(RECORD)
HDD Overwrite: NO
Record IPS: 25A
Record Quality: Normal
Alarm Rec IPS: 25A
Alarm Rec Quality: Normal
Motion Trigger Record: ON

(Menu)
Search
Timer
?
Record
Alarm
Remote
System
Event

HDD Overwrite Setup:

1. Press **ENTER** to confirm HDD OVERWRITE setup.
2. Press ? / ? to choose HDD OVERWRITE.
NO: When HDD full will stop recording
YES: When HDD full will overwrite the HDD recording
3. Press **MENU** to exit and confirm current operation.
4. Press **MENU** again to exit and close HDD OVERWRITE setup mode.

Record IPS Setup:

1. Press **ENTER** to confirm RECORD IPS setup.
2. Press ? / ? to choose IPS record speed. **Note that '15A' indicates 15 ips with audio.**
NTSC: 25A, 15, 8, 4, 2, 1
PAL: 18A, 12, 6, 3, 2, 1
3. Press **MENU** to exit and confirm current operation.
4. Press **MENU** again to exit and close RECORD IPS setup mode.

Record Quality Setup

1. Press **ENTER** to confirm Record Quality setup.
2. Press ? / ? to choose Record Quality level.
BEST, HIGH, NORMAL, BASIC
3. Press **MENU** to exit and confirm current operation.
4. Press **MENU** again to exit and close RECORD QUALITY setup mode.

Alarm REC IPS setup

1. Press **ENTER** to confirm ALARM REC IPS setup.
2. Press ? / ? to choose ALARM REC IPS record speed.
NTSC: 15A, 15, 8, 4, 2, 1
PAL: 12A, 12, 6, 3, 2, 1
3. Press **MENU** to exit and confirm current operation.
4. Press **MENU** again to exit and close ALARM REC IPS setup mode.

Alarm REC Quality setup



1. Press **ENTER** to confirm ALARM REC QUALITY setup.
2. Press ? / ? to choose ALARM REC QUALITY level.
BEST, HIGH, NORMAL, BASIC
3. Press **MENU** to exit and confirm current operation.
4. Press **MENU** again to exit and close ALARM REC QUALITY setup mode.

Motion Trigger Record

1. Press **ENTER** to confirm MOTION TRIGGER RECORD setup.
2. Press ? / ? to toggle the option between ON and OFF.

Camera Channel Setup

To access the Camera option, press **MENU** followed by the 4-digit password. Use the ? /? to scroll to the Camera option and press **ENTER**.

TITLE	DWELL				ALARM	RECORD
---01	ON	5	5	5	LOW	EVENT
---02	ON	5	5	5	LOW	EVENT
---03	ON	5	5	5	LOW	EVENT
---04	ON	5	5	5	LOW	EVENT

The options available in this section are as follows...

Title

This feature is used to assign a 6-character title to each camera input.

1. Press ? /? to select the desired time camera channel (1-9), and then press **ENTER**.
2. Press ? /? to select the desired character and ? /? to move to the next character
3. Press **MENU** to confirm and exit the **Title** setting.
4. Press **MENU** again to exit the Camera Setup Option

Dwell

This feature is used to enable or disable the dwell feature for each camera when viewing using the call monitor output.

1. Press ? /? to select the desired time camera channel (1-9), then press **ENTER**.
2. Press ? /? to select the **Dwell** feature on the screen.
3. Press **MENU** to confirm and exit the dwell setting.
4. Press **MENU** again to exit the Camera Setup Option

Brightness / Contrast / Color

This feature is used to adjust the video settings on each channel.

1. Press ? /? to select the desired time camera channel (1-9), then press **ENTER**.
2. Press ? /? to select the **Brightness, Contrast, or Color** feature on the screen.
3. Press ? /? to select **0~9** on the screen.
4. Press **MENU** to confirm and exit the **Brightness, Contrast, or Color** control feature
5. Press **MENU** again to exit the Camera Setup Option

Alarm Polarity

This feature is used to select the alarm polarity as LOW / OFF / HIGH.

1. Press ? /? to select the desired time camera channel (1-9), then press **ENTER**.
2. Press ? /? to select the **Alarm Polarity** feature on the screen.
3. Press ? /? to select **LOW / OFF / HIGH** on the screen.
4. Press **MENU** to confirm and exit the **Alarm Polarity** feature
5. Press **MENU** again to exit the Camera Setup Option

Record Method

This feature is used to select the DVR record method as either EVENT / NORMAL / OFF.

1. Press ? /? to select the desired time camera channel (1-9), then press **ENTER**.
2. Press ? /? to select the **Record Method** feature on the screen.
3. Press ? /? to select **EVENT/ NORMAL/ OFF** on the screen.

EVENT: when the alarm input is triggered, the DVR will increase the recording time to that channel.
i.e. the normal record sequence for cameras is camera 1, camera 2, camera 3 etc... In Event mode, when an alarm is triggered from channel 1, the DVR will record using the following sequence...., Camera 1, Camera 2, Camera 1, Camera 3, Camera 1, Camera 4 etc...

NORMAL: When an External Audible Alarm is triggered, the DVR will record normally as set up.

OFF: An Alarm Trigger will not cause the DVR to start recording

4. Press **MENU** to confirm and exit the **Record Method** feature
5. Press **MENU** again to exit the Camera Setup Option

Motion Detection

The Motion Detect feature provides a visual indication on the monitor when movement is detected in the picture. Also, if the 'Motion Trigger Record' option is enabled in the 'Record' menu, recording will active on all cameras when motion is detected. Use the steps below to enable/disable the detection zones for each camera.

Press **MENU** to enter the menu set up, then **?** to **CAMERA** setup.
Press **ENTER** twice to enter the Motion Detection Setup.

Each screen displays the current camera picture overlaid with the motion targets (as [Figure 1](#)). Pressing the **?** / **?** , **?** / **?** buttons will toggle the motion detection between **ON** or **OFF**.

The targets on each motion setup can be turned ON or OFF individually by row. To set up targets, using the following front panel buttons:

1. Press **ENTER** to confirm the channel
2. Press **ENTER** to enter motion mode
3. **?** moves the target cursor up one row at a time.
4. **?** moves the target cursor down one row at a time.
5. **?** moves the target cursor left one column at a time.
6. **?** moves the target cursor right one column at a time.
7. Press **ENTER** to turn the target cursor ON
Press **ENTER** again to turn the target cursor OFF
8. **Camera Select (1-15)** toggles the corresponding target on the cursor line ON or OFF. (see [Figure 1.1](#)) There are only 15 targets in a row, therefore; only Camera Selected (1-15) can be operated.
9. **Zoom**: turns all targets in the current row ON or OFF. ([Figure 1-2](#))
10. **PIP**: turns all targets on the screen ON or OFF. ([Figure 1-3](#))

Press **SLOW** button to setup the Sensitivity list **up to 255**

1. Press REC button to setup the Sensitivity list down to 000
2. Sensitivity value is related to motion and brightness change.
3. Low value (as 001) means higher sensitivity on motion and brightness change.
4. High value (as 255) means lower sensitivity on motion and brightness change.
User can choose the suitable sensitivity value in different locations. The default value is set on 32.

Figure 1 **MOTION DETECTION SETUP**

1	2	3	4	5	6	7	8	9	10	11	12	13	14	15
☒	☒	☒	☒	☒	☒	☒	☒	☒	☒	☒	☒	☒	☒	☒
☒	☒	☒	☒	☒	☒	☒	☒	☒	☒	☒	☒	☒	☒	☒
☒	☒	☒	☒	☒	☒	☒	☒	☒	☒	☒	☒	☒	☒	☒
☒	☒	☒	☒	☒	☒	☒	☒	☒	☒	☒	☒	☒	☒	☒
☒	--	--	--	--	--	--	--	--	--	--	--	--	--	--
☒	☒	☒	☒	☒	☒	☒	☒	☒	☒	☒	☒	☒	☒	☒
☒	☒	☒	☒	☒	☒	☒	☒	☒	☒	☒	☒	☒	☒	☒
☒	☒	☒	☒	☒	☒	☒	☒	☒	☒	☒	☒	☒	☒	☒
☒	☒	☒	☒	☒	☒	☒	☒	☒	☒	☒	☒	☒	☒	☒

Figure 1-1 MOTION DETECTION SETUP – 1~9

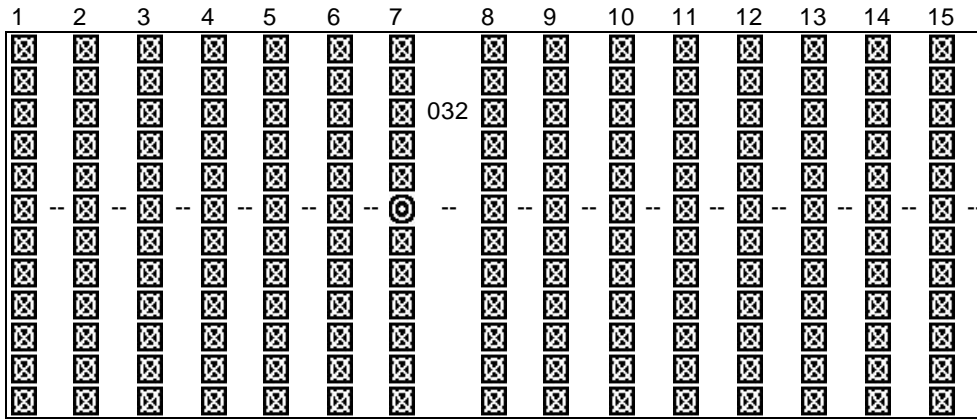

Figure 1-2 MOTION DETECTION SETUP – LINE

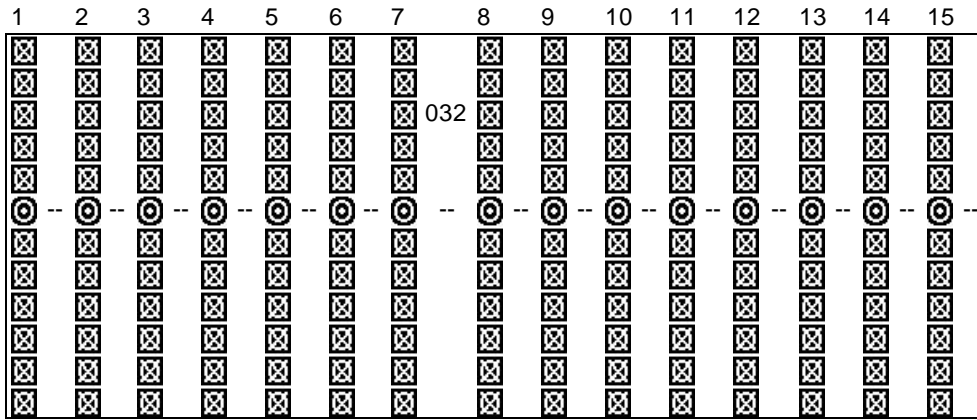
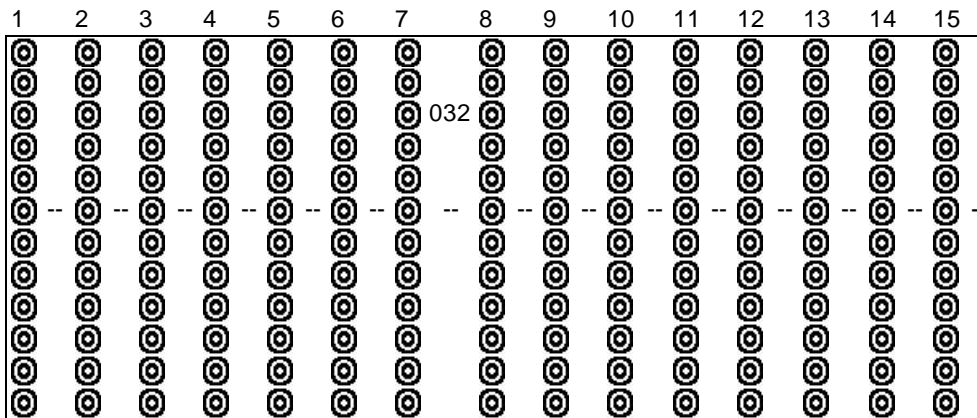

Figure 1-3 MOTION DETECTION SETUP – ALL



Event Log Viewing

To access the Event Log Viewing option, press **MENU** followed by the 4-digit password. Use the ? / ? to scroll to the **Event** option and press **ENTER** to view the list of logged events.

Use the ? / ? to scroll through the events on the display and ? / ? to go to the next page. To view the video associated with an event, scroll to the event and press **ENTER**.

The following is a list of events that can be displayed on the DXR109.

M-HDD WARNING:	Master HDD might be failed
M-HDD LOSS:	Master HDD does not exist. User can use other HDD.
M-HDD ERROR:	Master HDD may contain error.
S-HDD WARNING:	Slave HDD may have failed.
S-HDD LOSS:	Slave HDD does not exist. User can use other HDD
S-HDD ERROR:	Slave HDD may contain error.
HDD FULL:	HDD is full.
SYSTEM ERROR:	System may have failed.
-----02 VLOSS:	Channel: 2 Video Loss
-----03 ALARM:	Channel: 3 External I/O Alarm triggered.
POWER RESTORE:	Power restore.

(Menu)
Search
Timer
Record
Alarm
Remote
System
? Event

Operation

On Screen Display (OSD)

The DXR109 will display all current status on the OSD.

Here is an example of the display.

The following status will be shown:

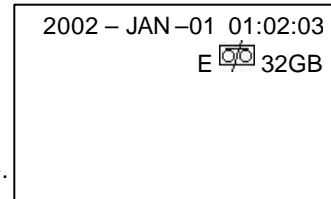

Time and Date – The current time and date will be shown on the first line.

Record Type – The current recording method will be shown:
M= Manual, T= Timer, A= Alarm, E= External Trigger

Record Status – An  icon will be displayed when the unit is currently recording

HDD Status – This will display either the remaining HDD capacity in GB or OW to indicate that it is set to Overwrite.

Video Loss - Screen will display  if the video input is not connected properly.

Recording Methods

The DXR109 offers a variety of flexible recording modes. The unit can be set up to record continually, following a schedule, or by record events. In addition, the recording speed and resolution is also configurable (*these options are configurable through the system menu*). Under the recording status, if power is stopped accidentally, recorded video will still be stored in the HDD and will be available when the power is restored, and the original recording setup will remain.

When recording, the top line of the display will show the date, time, and the amount of available HDD memory (in GB).

In the example below, the letter “A” represents the alarm trigger and the letters “OW” represents HDD over write.

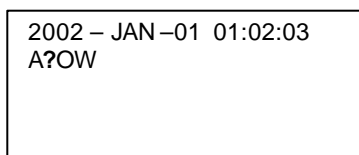

There are 3 record modes for DXR109: Alarm Record, Timer Record, and Manual Record.

- 1. Alarm Record**
The display will indicate a recording triggered by an Alarm using the letter “A”.
- 2. Timer Record**
The display will indicate a scheduled recording using the letter “T”.
- 3. Manual Record**
The display will indicate a manual recording (by pressing the REC button) using the letter “M”.
- 4. Motion Trigger Record**
Recording will be triggered by motion sensing and is indicated with the letter ‘D’.



Viewing Options:

Individual Camera Select (1 - 9):

Press Camera Select (1 - 9) button to select the desired camera to display in full screen mode.

Multi View Select:

This button is used to select the ideal viewing configuration.

1. Press the    buttons to toggle the camera views.

Picture in Picture (PIP):

This button is used to configure the monitor so a full screen is displayed in the background with a 1/16th size screen insert.

1. Press the  button to display the PIP mode.
2. Press **SELECT** then ? / ? button to move the insert screen.
3. Press **MENU** to exit

Zoom:

Feature is used to enlarge the display (2X) the size of the main picture. The screen will now display the “zoomed” picture as the main picture with a small window inserted containing a moveable 1/4 view size of the appointed camera.

1. Select the desired camera by pressing Camera Select (1-9).
2. Press the **Zoom** button to zoom the image on the display.
3. Press the **Zoom** button again to move the zoom pointer.
4. Press **MENU** to exit

Video Search

The DVR allows you to easily find sections of recorded video using the Search feature.

Press the SEARCH button and you will see the following options:

Last Record: Plays the last recorded piece of video.

Full List: Shows a listing of all recorded video on the HDD, sorted by time.

Alarm List: Shows a listing of all recorded video triggered by an Alarm.

Time Search: Finds video recorded on a specific date that is entered.

? Last Record Full List Alarm List Time Search

? M 2002-JAN-01 01:02:03 M 2002-JAN-01 01:02:03 A 2002-JAN-01 01:02:03 T 2002-JAN-01 01:02:03 E 2002-JAN-01 01:02:03 M 2002-JAN-01 01:02:03 ? : Page Up ? : Page Down

An example of a Full List search is shown on the left.

Note that the date and time appear, along with the letter representing the method of recording that took place.

Simply press ENTER to view a selected piece of video on the list. The DVR will play that video, followed by the next video in chronological order, until it hits the End of the list. You can stop the video at any time by pressing the STOP button.

Playing Back Video

Pressing **PLAY** while in Normal operation will play back the most recently recorded video clip. The controls below will allow you further controls over the playback whether in this mode or when viewing video from the Search mode.

Fast forward - Press **PLAY** on the front panel, then press **FF/?** to open the fast forward search screen. Press **FF/?** once to increase the speed to 2X, twice to increase the speed to 4X, and so on. The maximum fast forward speed is 32X.

Fast Reverse - Press **PLAY** on the front panel, then press **REW/?** to open the fast reverse search screen. Press **REW/?** once to increase the reverse speed to 2X, twice to increase the reverse speed to 4X, and so on. The maximum fast rewind speed is 32X.

Slow forward - Press **PLAY** on the front panel, then press **SLOW** for slow play. Press **FF/?** to play images at slow speed (1/2X). Press **FF/?** again to slow the speed to 1/4X. Continue to press **FF/?** to slow down the speed. The minimum slow speed is 1/32X.

- Slow reverse** Press **PLAY** on the front panel, then press **SLOW** for slow forward. Press **REW/?** to play images slowly forward (1/2X). Press **REW/?** again to slow the speed to 1/4X. Continue to press **REW/?** to slow down the speed. The minimum slow forward speed is 1/32X.
- Image Jog** Press **PLAY** on the front panel, then press **PAUSE** to lock the current image on the screen. Press **FF/?** to select single image play. Each time you press **FF/?** the next image will display. Continuing to press **FF/?** will result in forward image-by-image playback. Pressing **REW/?** will result in reverse image by image playback.
- Pause** Press **PLAY** on the front panel, and then press **PAUSE/?** to lock the current image on the screen.
- Stop** Press **STOP** on the front panel whenever you want to return the **DVR** to live monitoring mode.

Key Lock

For added security, you can Lock the buttons on your DXR109. Locking disables the functionality of the buttons and prevents accidental key presses from altering the operation of the DXR109.

To **enable** the Key Lock feature, press and hold the **ENTER** and **MENU** at the same time.

To **disable** the Key Lock feature when it is locked, press and the **ENTER** and **MENU** at the same time.

Troubleshooting

PROBLEM	SOLUTION
HDD not found	Need to insert HDD Make sure that the HDD Cartridge is locked, then press any key to continue
No Power	Check the power source cord connections Check that there is power at the outlet
Buttons aren't working when pressed	Check if the system is in Key Lock mode Press MENU and ENTER at the same time to escape the Key Lock mode
No recorded video	Check that the HDD has been installed correctly
Timer / Alarm recording isn't working	Check that Timer / Alarm Enable is set to YES
No video	Check camera's video cables and connections Check monitor's video cables and

Technical Specifications

Video format	NTSC/EIA or PAL/CCIR
HDD storage	IDE type, UTMA 66 above, 1 removable HDD supported
Record mode	Manual / Alarm / Timer
Camera input signal	Composite video signal 1 Vp-p 750 BNC, 9 Channels
Camera loop back	Composite video signal 1 Vp-p 750 BNC, 9 Channels
Main monitor output	Composite video signal 1 Vp-p 750 BNC
Call monitor output	Composite video signal 1 Vp-p 750 BNC
Audio input/ output	4 audio inputs, (RCA) and 2 audio outputs, (RCA)
Motion detect area	15 X 12 Targets per camera (NTSC)/ 15*14 targets per camera (PAL)
Motion detect sensitivity	256 Levels
Video loss detection	Yes
Refresh rate	72 IPS for NTSC / 100 IPS for PAL
Recording rate	25 IPS for NTSC / 12 IPS for PAL
Dwell time	Programmable (1 - 10 Sec)
Picture in picture	Yes (Moveable)
Key lock	Yes
Picture zoom	2X (Moveable)
Camera title	6 Characters
Video adjustable	Color / Contrast / Brightness Adjustable
Alarm input / output	Input: TTL input, Hi (5V), Low (GND) Output: COM,/N.O/N.C
Remote control	RS-232 or RS-485
Time display format	YY/NN/DD, DD/MM/YY, MM/DD/YY, OFF
Power source	AC 100-240V +/- 10% switching adaptor
Power consumption	<45W
Operation temperature	10 - 40 degrees C
RS - 232c / RS-485	115200, 57600, 19200, 9600, 4800, 3600, 2400, 1200 bps
Dimension (mm)	432 (W) x 110 (H) x 325 (D)
Net weight	5.7 Kgs

Because our products are subject to continuous improvement, SVII and its subsidiaries reserve the right to modify product design and specifications without notice and without incurring any obligation. E&OE

Appendix 1: Installing the HDD

NOTE: The HDD has the same purpose in a DXR109 as a videocassette does in a VCR. However, installing the HDD is a bit more complicated. Please follow the next steps carefully in order to ensure proper installation.

The compartment (with the handle) located on the front panel of the DXR109 is the removable Cartridge Casing where the HDD is inserted. The various parts of the Cartridge Casing are labeled for your reference.

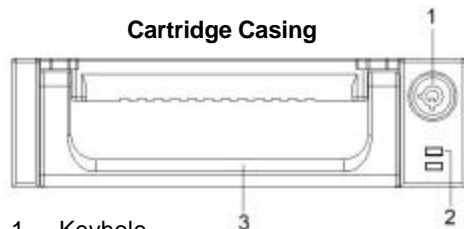

1. Keyhole
2. LED indicator lights (Power indicator & HDD Access indicator)
3. Handle

Step 1: Remove the Cartridge Casing from the DXR109

Lift the Handle and pull towards you. The Cartridge Casing will slide out of the DXR109.

NOTE: The Cartridge must be unlocked to remove it, (please see [step 8](#) for more information on locking and unlocking the removable HDD cartridge).

Step 2: Remove the Cover from the Cartridge Casing

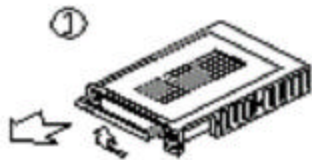

Step 3: Unclip the release latch with the word "OPEN," printed beside it by gently pushing on the latch.

Step 4: Slide the cover off the Cartridge Casing.

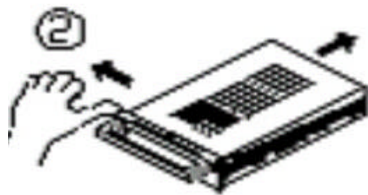

Step 5: Insert the HDD into the Cartridge Casing



Take the Hard Disk Drive and connect the two cables from the back of the Cartridge Casing to the HDD.

The cables should be pushed in firmly, but not forcibly.

Step 6: Secure the HDD in the cartridge casing.

Position the HDD into place and secure it using the six screws supplied.

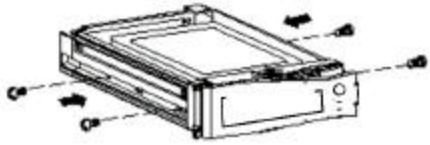

Step 7: Slide the top Cover over the Cartridge Casing

Slide the Cover forward over the Cartridge Case. Ensure it is secured in place over the release latch.

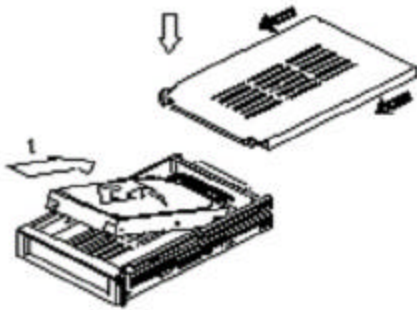

Reinsert the Cartridge Casing into the DXR109

Step 8: Lock the Cartridge

To Lock the cabinet, turn the key clockwise to Position A.

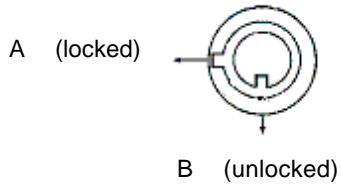

To unlock the cabinet, turn the key counter-clockwise to Position B.

NOTE: The DXR109 will not function if the key is not in the locked position.

Appendix 2: Connection Diagram to Cameras and Monitor

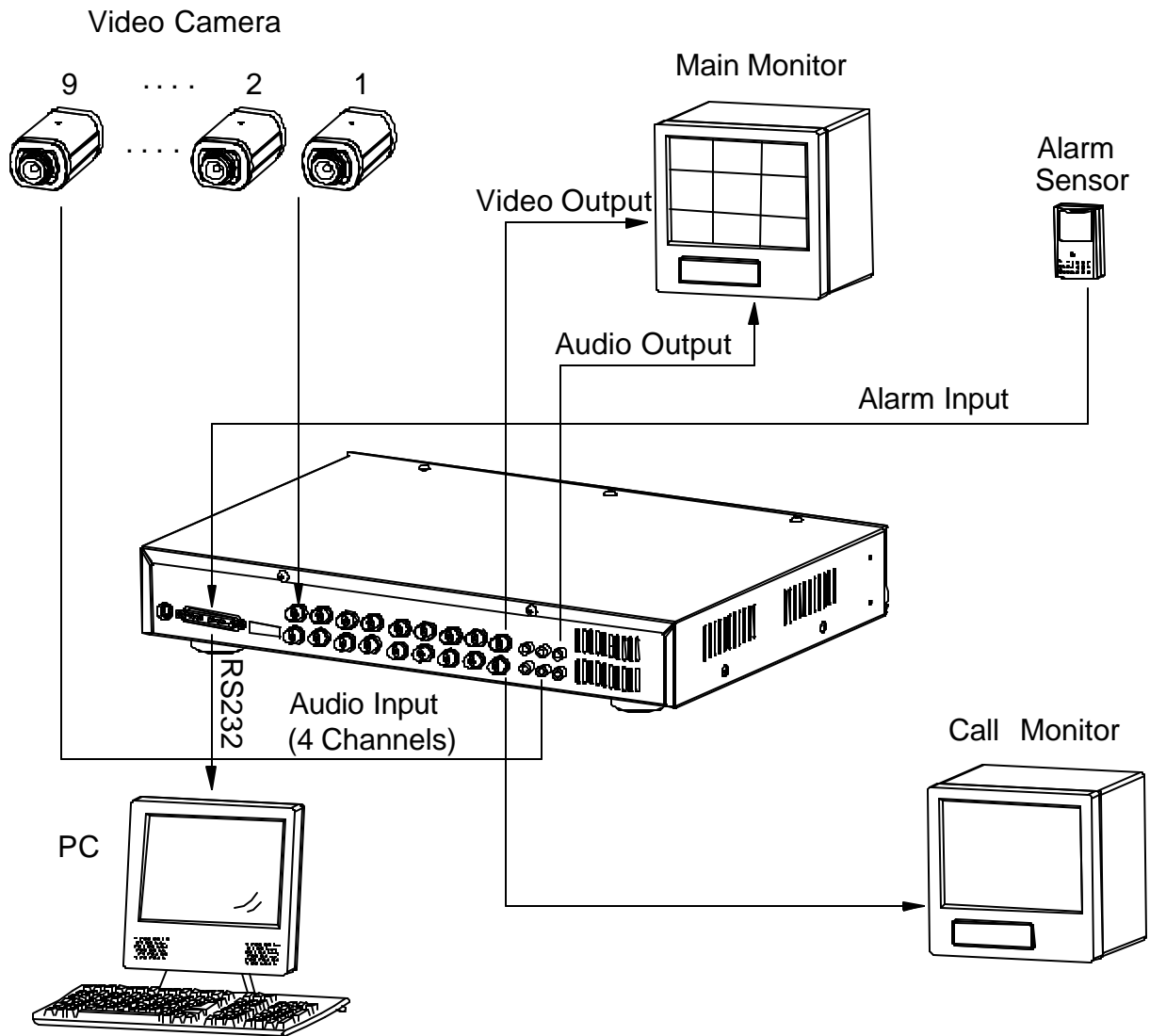

Appendix 3: Pin Configurations

9 pin Com Port

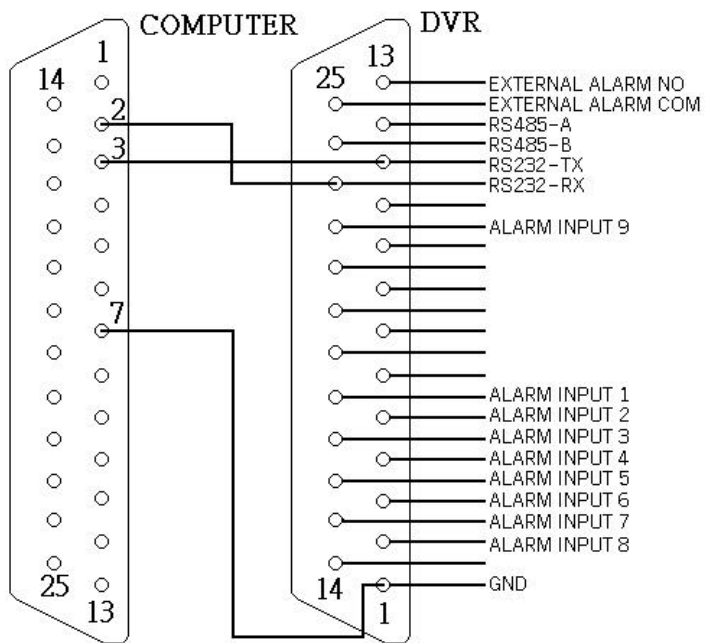

25 Pin Com Port

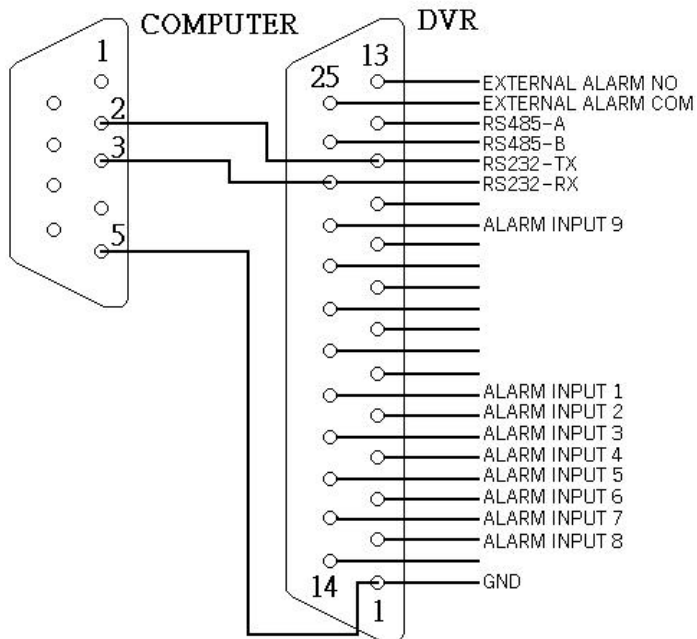

Pin References for RS-232 / Alarm Block

PIN 1. GND

GROUND

PIN 18. ALARM INPUT 1

Used to connect an alarm sensor between **ALARM INPUT 1 (PIN 18)** and **GND (PIN 1)** to trigger an alarm on Camera 1, which can activate the internal audible alarm and start recording.

PIN 5. ALARM INPUT 2

Used to connect an alarm sensor between **ALARM INPUT 2 (PIN 5)** and **GND (PIN 1)** to trigger an alarm on Camera 2 which can activate the internal audible alarm and start recording.

PIN 17. ALARM INPUT 3

Used to connect an alarm sensor between **ALARM INPUT 3 (PIN 17)** and **GND (PIN 1)** to trigger an alarm on Camera 3 which can activate the internal audible alarm and start recording.

PIN 4. ALARM INPUT 4

Used to connect an alarm sensor between **ALARM INPUT 4 (PIN 4)** and **GND (PIN 1)** to trigger an alarm on Camera 4 which can activate the internal audible alarm and start recording.

PIN 16. ALARM INPUT 5

Used to connect an alarm sensor between **ALARM INPUT 5 (PIN 4)** and **GND (PIN 1)** to trigger an alarm on Camera 5 which can activate the internal audible alarm and start recording.

PIN 3. ALARM INPUT 6

Used to connect an alarm sensor between **ALARM INPUT 6 (PIN 4)** and **GND (PIN 1)** to trigger an alarm on Camera 6 which can activate the internal audible alarm and start recording.

PIN 15. ALARM INPUT 7

Used to connect an alarm sensor between **ALARM INPUT 7 (PIN 4)** and **GND (PIN 1)** to trigger an alarm on Camera 7 which can activate the internal audible alarm and start recording.

PIN 2. ALARM INPUT 8

Used to connect an alarm sensor between **ALARM INPUT 8 (PIN 4)** and **GND (PIN 1)** to trigger an alarm on Camera 8 which can activate the internal audible alarm and start recording.

PIN 22. ALARM INPUT 9

Used to connect an alarm sensor between **ALARM INPUT 9 (PIN 4)** and **GND (PIN 1)** to trigger an alarm on Camera 9 which can activate the internal audible alarm and start recording.

PIN 11. RS232-TX

The DVR can be controlled remotely by an external device or control system, such as a control keyboard, using RS-232 serial communications signals.

PIN 23. RS232-RX

The DVR can be controlled remotely by an external device or control system, such as a control keyboard, using RS-232 serial communications signals.

PIN 12. RS485-A

The DVR can be controlled remotely by an external device or control system, such as a control keyboard, using RS485 serial communications signals.

PIN 24. RS485-B

The DVR can be controlled remotely by an external device or control system, such as a control keyboard, using RS485 serial communications signals.

PIN 13. EXTERNAL ALARM NO

Under normal operation COM disconnect with NO. But when Alarm triggered, COM connect with NO.

PIN 25. EXTERNAL ALARM COM

Under normal operation COM disconnect with NO. But when alarm triggered, COM connect with NO.

Appendix 4: Rack Mount Installation

Screws and brackets for rack mounting applications can be purchased as an optional accessory.

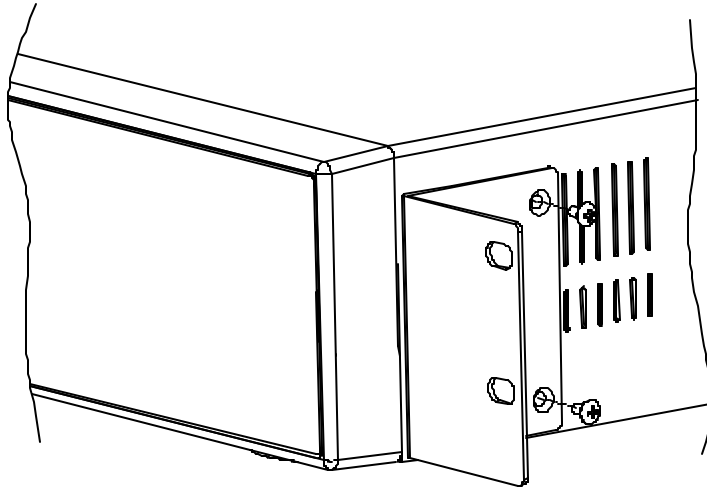

Front Angle with Rack Mount

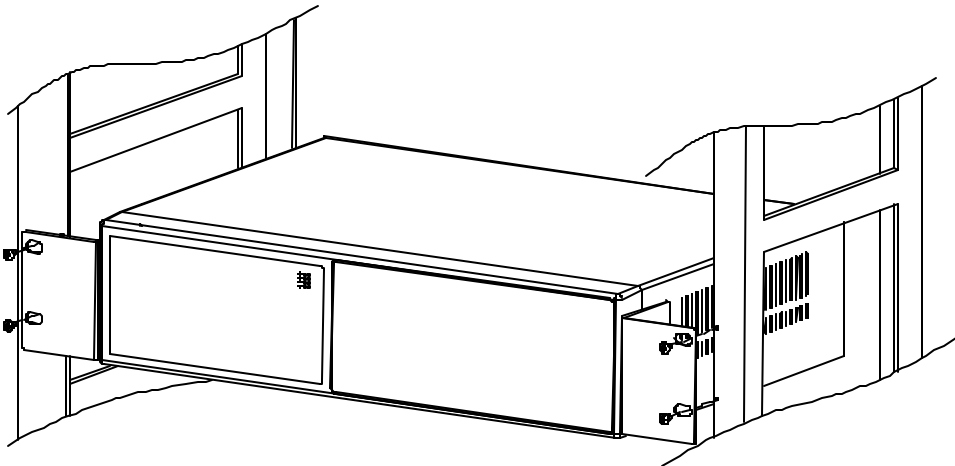

Side View with Rack Mount

For more information about the rack mount & other accessories through Strategic Vista, please visit:
www.strategicvista.com

Appendix 5: Recording Times (in Hours)

NTSC SYSTEM

IPS		25A	15	8	4	2	1
Record Quality	Best	16hr	32hr	60hr	120hr	240hr	480hr
	High	20hr	40hr	75hr	150hr	300hr	600hr
	Normal	32hr	64hr	120hr	240hr	480hr	960hr
	Basic	54hr	105hr	200hr	400hr	800hr	1600hr
HDD Type		80GB					

IPS		25A	15	8	4	2	1
Record Quality	Best	24hr	48hr	90hr	180hr	360hr	720hr
	High	30hr	60hr	1136hr	225hr	450hr	900hr
	Normal	48hr	96hr	1600hr	360hr	720hr	1440hr
	Basic	80hr	160hr	300hr	600hr	1200hr	2400hr
HDD Type		120GB					

NOTE: The above data has been taken from actual test data obtained using recordings from a normal TV program and is to be used for reference purposes only.

Appendix 6: RS232 Remote Protocol

The RS-232 protocol allows you to control the DXR109 from a PC or any other serial device.

Data: 8 bit data, 1 start bit, 1 stop bit

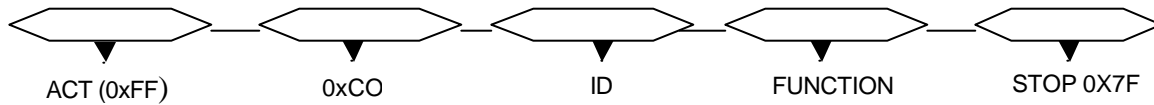

FUNCTION	CODE	ASCII	FUNCTION	CODE	ASCII
KEY_MENU	0x4D	M	KEY_CH1	0x31	1
KEY_SELECT	0x73	s	KEY_CH2	0x32	2
KEY_ENTER	0x0D	ENTER	KEY_CH3	0x33	3
KEY_4CUT	0x61	a	KEY_CH4	0x34	4
KEY_ZOOM	0x5A	Z	KEY_CH5	0x35	5
KEY_9CUT	0x62	b	KEY_CH6	0x36	6
KEY_PIP	0x70	p	KEY_CH7	0x37	7
KEY_16CUT	0x63	c	KEY_CH8	0x38	8
KEY_SLOW	0x53	S	KEY_CH9	0x39	9
KEY_REC	0x72	r			
KEY_LEFT	0x4C	L			
KEY_UP	0x55	U			
KEY_PLAY	0x50	P			
KEY_DOWN	0x4E	N			
KEY_RIGHT	0x52	R			
KEY_POWER	0x57	W			
KEY_KEY_LOCK	0x4B	K			

Appendix 7: Compatible HDD Brands

Manufacturer	Model	Capacity	Rotation
HITACHI	Deskstar 180 GXP (120 GB)	120GB	7200 rpm
HITACHI	Deskstar 7K250, HDS722516VLAT20	160GB	7200rpm
HITACHI	Deskstar 7K250, HDS722525VLAT80	250GB	7200rpm
IBM	Deskstar 120GXP (80GB)	80GB	7200 rpm
IBM	Deskstar 120GXP (120GB)	120GB	7200 rpm
Maxtor	DiamondMax 536DX(60GB) 4W060H4	60GB	5400rpm
Maxtor	DiamondMax Plus 9	80GB	7200 rpm
Maxtor	DiamondMax Plus 9, Model#6Y120L	120GB	7200 rpm
Maxtor	DiamondMax Plus 9, Model#6Y160L0	160GB	7200rpm
Seagate	Barracuda ATA IV, ST380021A	80GB	7200rpm
Seagate	Barracuda ATA V, ST3120023A	120GB	7200 rpm
Seagate	Barracuda 7200.7 Plus, ST3160023A	160GB	7200 rpm
Western Digital	Caviar WD1200BB-00CAA1	120GB	7200rpm
Western Digital	Caviar WD2000BB-00DWA0	200GB	7200rpm

Note: The above brands and models of HDD have been tested and they are compatible with the DGR109.

LOREX PRODUCT LIMITED WARRANTY

LOREX warrants, to the original retail purchaser only (the "Purchaser"), that this item (the "Product") is free from manufacturing defects in material and workmanship, provided the Product is used in normal conditions and is installed and used in strict accordance with the instructions contained in the Product's Owner's Manual.

This warranty shall be for the following warranty periods (the "Warranty Period"), commencing on the date the Purchaser buys the Product at retail in an unused condition.

Parts and Labor: 1 year (Warranted parts do not include Bulbs, LED's and Batteries)

LOREX's obligations under this warranty shall be limited to the repair or replacement of any warranted parts found by LOREX to be defective in the Product, or, in LOREX sole discretion, the replacement of the Product found by LOREX to be defective.

Any replacement parts furnished by LOREX in connection with this warranty shall be warranted to the Purchaser for a period equal to the unexpired portion of Warranty Period for the Product.

Warranty Exclusions

This warranty does not apply to Bulbs, LED's and Batteries supplied with or forming part of the product.

This warranty is invalidated if other than LOREX accessories are or have been used in or in connection with the Product or in any modification or repair is made to the Product by other than a service depot authorized by LOREX.

This warranty does not apply to defects or damages arising by use of the Product in other than normal (including normal atmospheric, moisture and humidity conditions) or by installation or use of the Product other than in strict accordance with the instructions contained in the Product's owners Manual.

This warranty does not apply to defects in or damages to the Product caused by (i) negligent use of the Product, (ii) misuse or abuse of the Product, (iii) electrical short circuits or transients, (iv) Purchaser adjustments that are not covered in the Owner's Manual, (v) use of replacement parts not supplied by LOREX (vi) improper Product maintenance, or (viii) accident, fire, flood or other Acts of God.

LOREX reserves the right to make change in design or to make additions to or improvements in its products without incurring any obligation to modify any product which has already been manufactured.

This warranty is in lieu of other warranties, express or implied, and LOREX neither assumes nor authorizes any person to assume for it any other obligation or liability in connection with the sale or service of the Product. In no event shall LOREX be liable for any special or consequential damages arising from the use of the Product or arising from the malfunctioning or non-functioning of the Product, or for any delay in the performance of this warranty due to any cause beyond its control. This warranty shall not apply to the appearance or accessory items including, but not limited to cabinets, cabinet parts, knobs etc., and the uncrating, setup, installation or the removal and reinstallation of products after repair.

LOREX does not make any claims or warranties of any kind whatsoever regarding the Product's potential, ability or effectiveness to prevent minimize, or in any way affect personal or property damage or injury. LOREX is not responsible for any personal damage, loss or theft related to the Product or to its use for any harm, whether physical or mental related thereto. Any and all claims or statements, whether written or verbal, by salespeople, retailers, dealers or distributors to the contrary are not authorized by LOREX, and do not affect this provision of this warranty.

The purchaser may have other rights under state, provincial, or federal laws and where the whole or part of any item of this warranty is prohibited by such laws, it shall be deemed null and void, but the remainder of the warranty shall remain in effect.

Obtaining Service

Should the Product require service under this warranty, the Purchaser must provide LOREX with a copy of his/ her original, dated bill of sale, receipt or invoice, failing which LOREX will not perform any of its obligations under this warranty. To claim on this warranty, proceed with the following steps.

1. Pack the Product in a well-padded sturdy carton.

2. i). If the unit was purchased in the United States proceed as follows:

a. Include \$US 12.00 for monitors and VCR's and \$8.00 for Cameras for postage and handling (send check or money order, no cash please), along with a copy of your dated bill of sale, receipt, or invoice, plus a description of the Product's apparent malfunction and the telephone number where you can be reached during the day.

b. Return the unit to: Strategic Vista USA Inc.
C/O The Advantage Center
1955 Wehrle Drive
Williamsville NY 14221

ii). If the unit was purchased in Canada proceed as follows:

a. Include CDN \$18.00 for monitors and VCR's and \$12.00 for Cameras for postage and handling (send cheque or money order, no cash please), along with a copy of your dated bill of sale, receipt, or invoice, plus a description of the Product's apparent malfunction and the telephone number where you can be reached during the day.

b. Return the unit to: Strategic Vista Corp.
300 Alden Road, Markham, Ont. L3R 4C1

www.strategicvista.com

Always use discretion when installing video and/or audio surveillance equipment especially when there is perceived privacy. Inquire regarding federal, state and/or local regulations applicable to the lawful installation of video and or audio recording or surveillance. Party consent may be required.

Care & Maintenance

Please follow these instructions to ensure proper care and maintenance of this system

Keep your monitor and camera dry. If it gets wet, wipe it dry immediately.

Use and store your unit in normal temperature environment. Extreme temperatures can shorten the life of the electronic devices.

Handle the monitor carefully. Dropping it can cause serious damage to the unit.

Occasionally clean the unit with a damp cloth to keep it looking new. Do not use harsh chemicals, cleaning solvents, or strong detergents to clean the unit.

Keep the unit away from excessive dirt and dust. It can cause premature wear of parts.



Free Manuals Download Website

<http://myh66.com>

<http://usermanuals.us>

<http://www.somanuals.com>

<http://www.4manuals.cc>

<http://www.manual-lib.com>

<http://www.404manual.com>

<http://www.luxmanual.com>

<http://aubethermostatmanual.com>

Golf course search by state

<http://golfingnear.com>

Email search by domain

<http://emailbydomain.com>

Auto manuals search

<http://auto.somanuals.com>

TV manuals search

<http://tv.somanuals.com>