

4. Camera Specifications

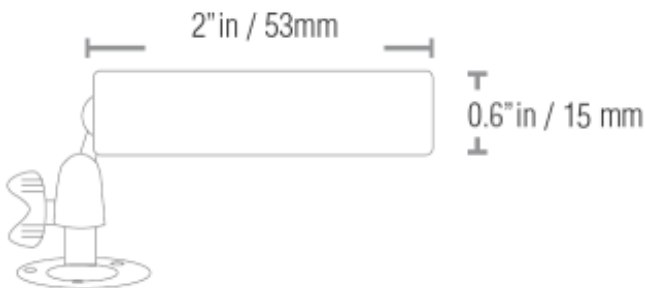





Specifications:

Image Sensor	1/4" Advanced Sensor
Video Format / Pixels	NTSC: 656(H) x 492 (V)
Horizontal Resolution	420 TVL
Sync. & Scan. Systems	Internal; 2:1 Interlace
S/N Ratio	48dB
Iris & Shutter Speed	AES; 1/60 ~ 1/50,000 sec.
Minimum Illumination	0.5 LUX
Video Output	Comp. 1.0 Vpp @ 75ohm
Lens / Lens Mount	3.6mm F2.0/ Fixed
FOV (Diagonal)	42 Degree
Termination	Video: BNC (Female) Power: Barrel (Female)
IR / Night Vision Range	None / N/A
Power Requirement	12V DC
Current Consumption	50mA (typical) @ 12V DC
Operating Temp	-4°F ~ 122°F (-10°C ~ 50°C)
Dimensions (w/o stand)	DIA: 0.6", L: 2" DIA: 15mm, L: 53mm
Weight (w/ stand)	121g / 4.27 oz.

Dimensions:



It's all on the web

-  Product Information
-  Specification Sheets
-  User Manuals
-  Software Upgrades
-  Quick Start Guides
-  Firmware Upgrades



VISIT
www.lorexcctv.com

LOREX Technology Inc.
Copyright © 2007 LOREX Technology Inc. As our products are subject to continuous improvement, LOREX and its subsidiaries reserve the right to modify product design, specifications and prices, without notice and without incurring any obligation. E&OE

HOME & BUSINESS SECURITY

**MICRO INDOOR/
OUTDOOR COLOR
BULLET CAMERA
WITH ADVANCED IMAGE SENSOR**

Model: SG4934W



Quick Set-up Guide

 **LOREX**

1. Package Contents



1 x Micro Indoor/
Outdoor Camera
1 x Stand



1 x 60 ft. Extension Cable
1 x BNC to RCA Adaptor



1 x Power Adaptor

WARNING - REGULATED 12V DC 200mA power supply is REQUIRED for use with this camera. Use of a non-regulated, non-conforming power supply can damage this product and will void the warranty.

Features:

- Advanced micro image sensor provides High Resolution image (420 TV Lines)
- Weatherproof Indoor/Outdoor camera*
- Easily connects to any TV, VCR with RCA Composite A/V inputs
- 60' of Cable included
- Excellent low light sensitivity (Min. 0.5 Lux)
- Ceiling and wall mounting bracket included

* Camera rated IP66 for resistance to snow and rain

NOTE: Test the camera prior to selecting a permanent mounting location by temporarily connecting the Cameras and cables to the TV, VCR, DVR or Observation System.

2. Installing the Camera

1. Attach the camera to the supplied stand.

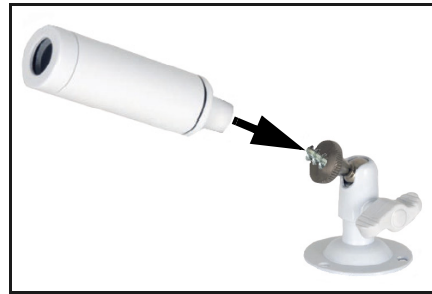

2. Mount the camera stand to the desired mounting surface (The mounting stand is designed to permanently mount the camera to a surface.)

3. Connect the 60ft Extension cable to the camera:

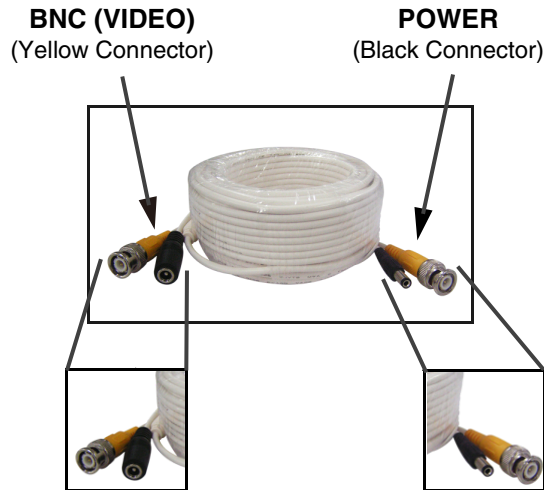

VIDEO INPUT CONNECTIONS:
Connect the BNC cable to the video input of the monitor, and connect the power adaptor to an outlet.

CAMERA CONNECTIONS:
Connect the BNC and Power cables to the Camera (Male power end).

Connect the Extension Cable to the Camera to confirm:

- The distance between the camera and viewing/recording device does not exceed the provided cable length (60')
- Proper cable connectivity to the Camera (Male Power End on the Extension Cable connects to the Camera Power Input)

NOTE: Extension Cable color may vary. Downloaded from www.manualsonline.com on 04-May-2014. Search And Download.

3. Connecting the Camera

4. Connect the BNC end of the 60ft Extension Cable to the DVR / Observation System or to a TV/VCR.

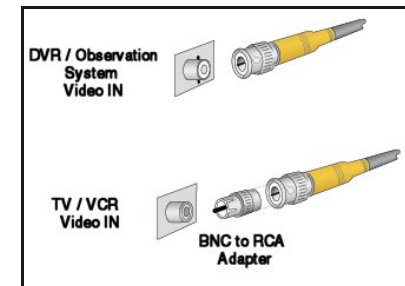

Connect the BNC to RCA Adaptor as needed to allow for proper connectivity.

5. Connect the A/C Power Adaptor to the 60ft Extension cable (Black connector). Plug the Power adaptor to a wall outlet



Setup Diagram:

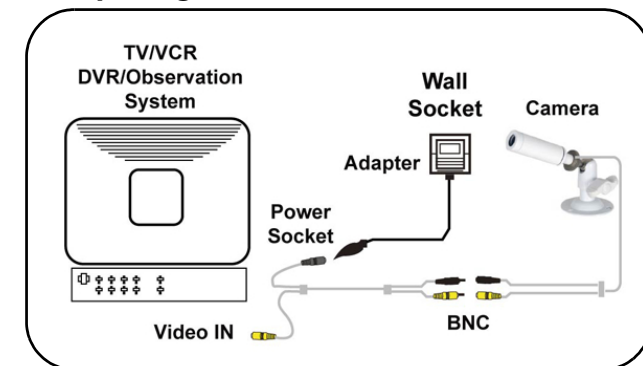

Free Manuals Download Website

<http://myh66.com>

<http://usermanuals.us>

<http://www.somanuals.com>

<http://www.4manuals.cc>

<http://www.manual-lib.com>

<http://www.404manual.com>

<http://www.luxmanual.com>

<http://aubethermostatmanual.com>

Golf course search by state

<http://golfingnear.com>

Email search by domain

<http://emailbydomain.com>

Auto manuals search

<http://auto.somanuals.com>

TV manuals search

<http://tv.somanuals.com>