

USER'S GUIDE

PCI Express to 3.0 Gbit/s Serial Attached SCSI (SAS) Host Adapters

Model Numbers:

LSISAS3041E, LSISAS3041EL
LSISAS3080E, LSISAS3080EL
LSISAS3081E, LSISAS3081EL
LSISAS3442E, LSISAS3442EL
LSISAS3443E, LSISAS3443EL
LSISAS3444E, LSISAS3444EL
LSISAS3800E
LSISAS3801E, LSISAS3801EL

August 2006

Version 1.0

LSI LOGIC®



Electromagnetic Compatibility Notices

This device complies with Part 15 of the FCC Rules. Operation is subject to the following two conditions:

1. This device may not cause harmful interference, and
2. This device must accept any interference received, including interference that may cause undesired operation.

This equipment has been tested and found to comply with the limits for a Class B digital device, pursuant to part 15 of the FCC Rules. These limits are designed to provide reasonable protection against harmful interference in a residential installation. This equipment generates, uses, and can radiate radio frequency energy and, if not installed and used in accordance with the instructions, may cause harmful interference to radio communications. However, there is no guarantee that interference will not occur in a particular installation. If this equipment does cause harmful interference to radio or television reception, which can be determined by turning the equipment off and on, the user is encouraged to try to correct the interference by one or more of the following measures:

- Reorient or relocate the receiving antenna.
- Increase the separation between the equipment and the receiver.
- Connect the equipment into an outlet on a circuit different from that to which the receiver is connected.
- Consult the dealer or an experienced radio/TV technician for help.

Shielded cables for SCSI connection external to the cabinet are used in the compliance testing of this Product. LSI Logic is not responsible for any radio or television interference caused by unauthorized modification of this equipment or the substitution or attachment of connecting cables and equipment other than those specified by LSI Logic. The correction of interferences caused by such unauthorized modification, substitution, or attachment will be the responsibility of the user.

The LSI Logic PCI Express to 3.0 Gbit/s SAS host adapters (LSISAS3041E, LSISAS3041EL, LSISAS3080E, LSISAS3080EL, LSISAS3081E, LSISAS3081EL, LSISAS3442E, LSISAS3442EL, LSISAS3443E, LSISAS3443EL, LSISAS3444E, LSISAS3444EL, LSISAS3800E, LSISAS3801E, and LSISAS3801EL) are tested to comply with FCC standards for home or office use.

This Class B digital apparatus meets all requirements of the Canadian Interference-Causing Equipment Regulations.

Cet appareil numérique de la classe B respecte toutes les exigences du Règlement sur le matériel brouilleur du Canada.

この装置は、情報処理装置等電波障害自主規制協議会（VCCI）の基準に基づくクラス B 情報技術装置です。この装置は、家庭環境で使用することを目的としていますが、この装置がラジオやテレビジョン受信機に近接して使用されると、受信障害を引き起こすことがあります。
取扱説明書に従って正しい取り扱いをして下さい。

This is a Class B product based on the standard of the Voluntary Control Council for Interference from Information Technology Equipment (VCCI). If this is used near a radio or television receiver in a domestic environment, it may cause radio interference. Install and use the equipment according to the instruction manual.



LSI Logic Asia, Inc. Taiwan Branch
10/F, 156, Min Sheng E. Rd., Section 3,
Taipei, Taiwan, R.O.C.
Tel: 886.2.2718.7828
FAX: 886.2.2718.8869

LSI Logic Corporation
North American Headquarters
Milpitas, CA
Tel: 408.433.8000

This document is preliminary. As such, it contains data derived from functional simulations and performance estimates. LSI Logic has not verified either the functional descriptions, or the electrical and mechanical specifications using production parts.

This document contains proprietary information of LSI Logic Corporation. The information contained herein is not to be used by or disclosed to third parties without the express written permission of an officer of LSI Logic Corporation.

LSI Logic products are not intended for use in life-support appliances, devices, or systems. Use of any LSI Logic product in such applications without written consent of the appropriate LSI Logic officer is prohibited.

Document DB15-000363-00, Version 1.0, August 2006

This document describes the LSI Logic Corporation LSISAS3041E, LSISAS3041EL, LSISAS3080E, LSISAS3080EL, LSISAS3081E, LSISAS3081EL, LSISAS3442E, LSISAS3442EL, LSISAS3443E, LSISAS3443EL, LSISAS3444E, LSISAS3444EL, LSISAS3800E, LSISAS3801E, and LSISAS3801EL PCI Express to 3.0 Gbit/s SAS host adapters and will remain the official reference source for all revisions/releases of these products until rescinded by an update.

LSI Logic Corporation reserves the right to make changes to any products herein at any time without notice. LSI Logic does not assume any responsibility or liability arising out of the application or use of any product described herein, except as expressly agreed to in writing by LSI Logic; nor does the purchase or use of a product from LSI Logic convey a license under any patent rights, copyrights, trademark rights, or any other of the intellectual property rights of LSI Logic or third parties.

Copyright © 2006 by LSI Logic Corporation. All rights reserved.

TRADEMARK ACKNOWLEDGMENT

LSI Logic, the LSI Logic logo design and Fusion-MPT are trademarks or registered trademarks of LSI Logic Corporation. Windows and Windows NT are registered trademarks of Microsoft Corporation. All other brand and product names may be trademarks of their respective companies.

DB

To receive product literature, visit us at <http://www.lsillogic.com>.

For a current list of our distributors, sales offices, and design resource centers, view our web page located at

<http://www.lsillogic.com/contacts/index.html>

Preface

This document is the user's guide for the LSI Logic PCI Express to 3.0 Gbit/s SAS host adapters, referred to as LSI PCIe to SAS host adapters. It contains a functional description of the LSI PCIe to SAS host adapters as well as physical and electrical specifications. It also contains instructions for installing the host adapters and for connecting SAS devices.

Audience

This document assumes that you have some familiarity with Serial Attached SCSI (SAS) devices and PCI Express devices. This document benefits people installing and using the LSI PCIe to SAS host adapter.

Organization

This document has the following chapters:

- [Chapter 1, Introduction](#), describes the LSI PCIe to SAS host adapters.
- [Chapter 2, Hardware Installation](#), describes how to install the LSI PCIe to SAS host adapters in a system.
- [Chapter 3, Host Adapter Characteristics](#), provides the environmental and electrical specifications for the LSI PCIe to SAS host adapters. This chapter also provides the mechanical drawings and connector locations for the LSI PCIe to SAS host adapters.

Related Publications

LSI Logic Documents

LSISAS1064E PCI Express to 4-Port Serial Attached SCSI Controller Technical Manual, Document No. DB14-000331-02

LSISAS1068E PCI Express to 8-Port Serial Attached SCSI Controller Technical Manual, Document No. DB14-000330-02

Fusion-MPT™ Device Management User's Guide, Document No. DB15-000186-01

Integrated RAID User's Guide, Document No. DB15-000292-00

Integrated RAID for SAS User's Guide, Document No. DB15-000357-00

LSI Logic World Wide Web Home Page

www.lsillogic.com

ANSI

11 West 42nd Street
New York, NY 10036
(212) 642-4900

InterNational Committee on Information Technology Standards (INCITIS) T10 Technical Committee

<http://www.t10.org>

Global Engineering Documents

15 Inverness Way East
Englewood, CO 80112
(800) 854-7179 or (303) 397-7956 (outside U.S.); FAX (303) 397-2740

PCI Special Interest Group

2575 N. E. Katherine
Hillsboro, OR 97214
(800) 433-5177; (503) 693-6232 (International); FAX (503) 693-8344

Revision Record

Version	Date	Remarks
1.0	8/2006	This release provides information about the LSISAS3041E, LSISAS3041EL, LSISAS3080E, LSISAS3080EL, LSISAS3081E, LSISAS3081EL, LSISAS3442E, LSISAS3442EL, LSISAS3443E, LSISAS3443EL, LSISAS3444E, LSISAS3444EL, LSISAS3800E, LSISAS3801E, and LSISAS3801EL PCI Express to 3.0 Gbit/s SAS host adapters. Several of these host adapters were previously featured in the 3 Gbit/s Serial Attached SCSI Host Adapters User's Guide (March 2006, Version 2.0).

Contents

Chapter 1

Introduction

1.1	Overview	1-1
1.2	Features	1-3
1.3	PCI Performance	1-4
	1.3.1 PCI Express Features	1-4
1.4	Software	1-6

Chapter 2

Hardware Installation

2.1	Quick Installation Instructions	2-1
2.2	Detailed Installation Instructions	2-2

Chapter 3

Host Adapter Characteristics

3.1	Characteristics of the LSI PCIe to SAS Host Adapters	3-1
3.1.1	LSISAS3041E and LSISAS3041EL Host Adapters Characteristics	3-2
3.1.2	LSISAS3080E and LSISAS3080EL Host Adapters Characteristics	3-4
3.1.3	LSISAS3081E and LSISAS3081EL Host Adapters Characteristics	3-6
3.1.4	LSISAS3442E and LSISAS3442EL Host Adapters Characteristics	3-8
3.1.5	LSISAS3443E and LSISAS3443EL Host Adapters Characteristics	3-10
3.1.6	LSISAS3444E and LSISAS3444EL Host Adapters Characteristics	3-12
3.1.7	LSISAS3800E Host Adapter Characteristics	3-14

3.1.8	LSISAS3801E and LSISAS3801EL Host Adapters Characteristics	3-16
3.2	Electrical and Environmental Specifications	3-18
3.2.1	Electrical Characteristics	3-18
3.2.2	Thermal and Atmospheric Characteristics	3-19
3.2.3	Safety Characteristics	3-19

Customer Feedback

Figures

2.1	Installing an LSI PCIe to SAS x8 Host Adapter in a PCI Express Slot	2-3
3.1	LSISAS3041E and LSISAS3041EL Board Layout	3-3
3.2	LSISAS3080E and LSISAS3080EL Board Layout	3-5
3.3	LSISAS3081E and LSISAS3081EL Board Layout	3-7
3.4	LSISAS3442E and LSISAS3442EL Board Layout	3-9
3.5	LSISAS3443E and LSISAS3443EL Board Layout	3-11
3.6	LSISAS3444E and LSISAS3444EL Board Layout	3-13
3.7	LSISAS3800E Board Layout	3-15
3.8	LSISAS3801E and LSISAS3801EL Board Layout	3-17

Tables

1.1	LSI PCIe to SAS Host Adapters and Controllers	1-2
1.2	SAS Bandwidths	1-3
1.3	Software Support	1-6
3.1	Maximum Power Requirements	3-18

Chapter 1

Introduction

This chapter describes the LSI Logic PCI Express to 3.0 Gbit/s SAS host adapters and consists of the following sections:

- [Section 1.1, “Overview”](#)
 - [Section 1.2, “Features”](#)
 - [Section 1.3, “PCI Performance”](#)
 - [Section 1.4, “Software”](#)
-

1.1 Overview

The LSI PCIe to SAS host adapters provide four or eight serial ports for connection to SAS/SATA (Serial ATA) devices. Each port is capable of 3.0 Gbit/s SAS link rates and 3.0 Gbit/s SATA link rates. The PCI Express transmission and reception data rate is 2.5 Gbits/s in each direction, yielding a total bandwidth of 5.0 Gbits/s for each full-duplex lane. The LSI PCIe to SAS host adapters are implemented using four or eight PCI Express phys, which provide possible host-side maximum transmission and reception rates of up to 4.0 Gbytes/s.

The LSI PCIe to SAS host adapters contain Flash ROM for storing the BIOS and firmware, and NVSRAM for storing nonvolatile RAID information. The LSI SAS3442E, LSI SAS3442EL, LSI SAS3443E, LSI SAS3443EL, LSI SAS3444E, LSI SAS3444EL, LSI SAS3800E, LSI SAS3801E, and LSI SAS3801EL host adapters provide a 128 K x 36-bit PSRAM memory device for storing SAS Address Port information allowing for connection to more than 128 devices. The LEDs on the host adapters report a heartbeat, activity, and fault conditions when detected by firmware. Fusion-MPT™ firmware operates the host adapter.

The PCI Express interface is compliant with the *PCI Express Specification*, revision 1.0a. All PCI software is backwards compliant with previous versions of the PCI/PCI-X specifications. The LSI PCIe to SAS products implement the PCI Express interface as a x4 or x8 interface. The LSI PCIe to SAS host adapters use either a standard PCI or a low-profile PCI bracket type. The LSI PCIe to SAS host adapter SAS interface is compatible with the *ANSI Serial Attached SCSI Specification*, revision 1.0 and the *Serial ATA Specification*, revision 1.0a.

The functionality of LSI PCIe to SAS host adapters come from either the LSISAS1064E controller chip or the LSISAS1068E controller chips. The LSISAS1064E integrates four high-performance SAS/SATA phys and the LSISAS1068E integrates eight high-performance SAS/SATA phys. The design of LSI PCIe to SAS host adapters makes it easy to add SAS interfaces to any computer, workstation, or server with a PCI Express bus.

Table 1.1 shows the LSI PCIe to SAS controllers and their associated host adapters that support SAS/SATA devices. All board numbers contain an “E” after the numeric portion of their name, indicating that they use the PCI Express bus. Boards without an “L” after the numbers in their name use a standard PCI bracket type. Boards with an “L” after the numbers in their name use a low-profile PCI bracket type.

Table 1.1 LSI PCIe to SAS Host Adapters and Controllers

Controllers	LSI PCIe to SAS Host Adapters
LSISAS1064E	LSISAS3041E, LSISAS3041EL
LSISAS1068E	LSISAS3080E, LSISAS3080EL, LSISAS3081E, LSISAS3081EL, LSISAS3442E, LSISAS3442EL, LSISAS3443E, LSISAS3443EL, LSISAS3444E, LSISAS3444EL, LSISAS3800E, LSISAS3801E, LSISAS3801E

1.2 Features

This section lists features of the LSI PCIe to SAS host adapters:

- Supports narrow port and wide port as shown in [Table 1.2](#).

Table 1.2 SAS Bandwidths

Half Duplex	Full Duplex
Narrow Port (1 Lane)—300 Mbytes/s	Narrow Port (1 Lane)—600 Mbytes/s
Wide Port (2 Lanes)—600 Mbytes/s	Wide Port (2 Lanes)—1200 Mbytes/s
Wide Port (4 Lanes)—1200 Mbytes/s	Wide Port (4 Lanes)—2400 Mbytes/s

- Supports SSP, STP, and SMP as defined in the *Serial Attached SCSI (SAS) Specification*, version 1.0.
- Supports SATA as defined in the *Serial ATA Specification*, version 1.0a.
- Provides configurable drive spin-up sequencing on a per-phy basis.
- Simplifies cabling with a point-to-point, serial architecture.
- Provides smaller and thinner cables that do not restrict airflow.
- Provides a serial, point-to-point, enterprise-level storage interface.
- Transfers data using SCSI information units.
- Provides two LEDs for each phy to indicate link activity and faults for the LSISAS3041E, LSISAS3041EL, LSISAS3080E, LSISAS3080EL, LSISAS3081E, LSISAS3081EL, LSISAS3442E, LSISAS3442EL, LSISAS3443E, LSISAS3443EL, LSISAS3444E, LSISAS3444EL, LSISAS3800E, LSISAS3801E, and LSISAS3801EL host board adapters (HBAs).
- Provides two light pipes routed through the PCI bracket for the LSISAS3041E, LSISAS3041EL, LSISAS3080E, LSISAS3080EL, LSISAS3081E, LSISAS3081EL, LSISAS3442E, LSISAS3442EL, LSISAS3443E, LSISAS3443EL, LSISAS3444E, LSISAS3444EL, and LSISAS3800E host adapters. One light pipe indicates activity on any phy. The other light pipe indicates a heartbeat or a fault condition. The LSISAS3801E and LSISAS3801EL use two LEDs routed through the PCI bracket for the same purpose.
- Provides compatibility with SATA target devices.

1.3 PCI Performance

LSI PCIe to SAS host adapter boards support the PCI Express interface. The following lists are of their features.

1.3.1 PCI Express Features

The PCI Express features of the LSI PCIe to SAS host adapters include:

- Provides four (boards using LSISAS1064E) or eight (boards using LSISAS1068E) PCI Express phys
- Supports a single-phy (1 lane) link transfer rate up to 2.5 Gbits/s in each direction
- Supports x8, x4, and x1 link widths
- Automatically downshifts to a x4 link width if plugged into a x4 connector or into a x8 connector that is wired as a x4 connector
- Provides a scalable interface
 - Single-lane aggregate bandwidth of up to 0.5 Gbytes/s (500 Mbytes/s)
 - Quad-lane aggregate bandwidth of up to 2.0 Gbytes/s (2000 Mbytes/s)
 - 8-lane aggregate bandwidth of up to 4.0 Gbytes/s (4000 Mbytes/s)
- Supports serial, point-to-point interconnections between devices
 - Reduces the electrical load of the connection
 - Enables higher transmission and reception frequencies
- Supports lane reversal and polarity inversion
- Supports PCI Express Hot Plug
- Supports Power Management
 - Supports PCI Power Management 1.2
 - Supports Active State Power Management (ASPM), including the L0, L0s, L1 states, by placing links in a power-savings mode during times of no link activity

- Contains a replay buffer that preserves a copy of the data for retransmission in case a CRC error occurs
- Supports the PCI Express Advanced Error Reporting capabilities
- Uses a packetized and layered architecture
- Achieves a high bandwidth per pin with low overhead and low latency
- PCI Express is software compatible with PCI and PCI-X software
 - Leverages existing PCI device drivers
 - Supports the Memory, I/O, and Configuration address spaces
 - Supports memory read/write transactions, I/O read/write transactions, and configuration read/write transactions
- Provides 4 Kbytes of PCI Configuration address space per device
- Supports posted and non-posted transactions
- Provides quality of service (QOS) link configuration and arbitration policies
- Supports Traffic Class 0 and one virtual channel
- Supports Message Signaled Interrupts (both MSI and MSI-X) as well as INTx interrupt signaling for legacy PCI support
- Supports end-to-end CRC (ECRC) and Advanced Error Reporting

1.4 Software

The LSI PCIe to SAS host adapters support all major operating systems, as shown in [Table 1.3](#).

Table 1.3 Software Support

OS Support	Versions
Windows	XP, 2000, Server 2003 32-bit and 64-bit (x86, AMD, and IA-64)
Linux: Red Hat Enterprise Linux	(RHEL) 3 and 4
Linux: SuSE Enterprise Server	(SLES) 8 and 9
Novel NetWare	5.1 and 6.5
Sun Sparc Solaris	2.6, 2.7, 2.8, 2.9, and 2.10
Utilities	Install, Flash and BIOS Configuration Utility

The LSI PCIe to SAS host adapters use the Fusion-MPT architecture for all major operating systems, which allows for thinner drivers for better performance. To obtain a device driver that supports your operating system, contact the LSI Technical Support team at 719-533-7230 or visit our web site at <http://www.lsilogic.com>.

Chapter 2

Hardware Installation

This chapter provides both quick instructions and detailed instructions on how to install the LSI PCIe to 3.0 Gbit/s SAS host adapter. This chapter consists of the following sections:

- [Section 2.1, “Quick Installation Instructions”](#)
 - [Section 2.2, “Detailed Installation Instructions”](#)
-

2.1 Quick Installation Instructions

The following steps summarize the installation instructions.

Use these instructions to install your LSI PCIe to SAS host adapter if you are comfortable with the installation procedure. [Section 2.2, “Detailed Installation Instructions”](#) provides detailed installation instructions.

- Step 1. Unpack the host adapter and inspect it for damage.
- Step 2. Turn off the system and remove the power cord(s).
- Step 3. Remove the cover from the system.
- Step 4. Insert the host adapter in an available PCI Express slot.
- Step 5. Secure the bracket to the system's chassis.
- Step 6. Connect the serial cable(s) between the host adapter and the serial hard disk drive(s). [Figure 2.1](#) illustrates the locations of the connectors on your host adapter.
- Step 7. Replace the cover and the power cord(s), then power-up the system.

LSI PCIe to SAS host adapter hardware installation is complete.

2.2 Detailed Installation Instructions

The following steps provide detailed installation instructions:

- Step 1. Unpack the host adapter and inspect it for damage.

Unpack the host adapter in a static-free environment. Remove the host adapter from the anti-static bag and inspect it for damage. Contact LSI or your OEM support representative if the host adapter appears damaged.

- Step 2. Turn off the system and disconnect the power cord(s).

Turn off the system's power and physically remove the power cord(s) from the system.

- Step 3. Remove the cover from the system.

Remove the cover from the system's chassis. Disconnect the system from any networks.

- Step 4. Insert the host adapter in an available PCI Express slot.

Locate an empty PCI Express slot. Remove the blank bracket panel on the back of the computer that is aligned with the PCI Express slot you have selected. Save the bracket screw when present.

Align the host adapter to a PCI Express slot. Press down gently but firmly to properly seat the host adapter in the slot.

[Figure 2.1](#) illustrates how to insert the host adapter in a PCI Express slot.

- Step 5. Secure the bracket to the system's chassis.

Install the bracket screw, when present, or engage the system's retention mechanism to secure the host adapter to the system's chassis.

- Step 6. Connect the serial cable(s) between the host adapter and the serial hard disk drive(s) (HDD). [Figure 2.1](#) illustrates the locations of the connectors on your host adapter.

- Step 7. Replace the cover and the power cord(s), then power-up the system.

Replace the system's cover, reconnect the power cord(s) and any network cables. Turn power on to the system.

LSI PCIe to SAS host adapter hardware installation is complete.

Figure 2.1 Installing an LSI PCIe to SAS x8 Host Adapter in a PCI Express Slot

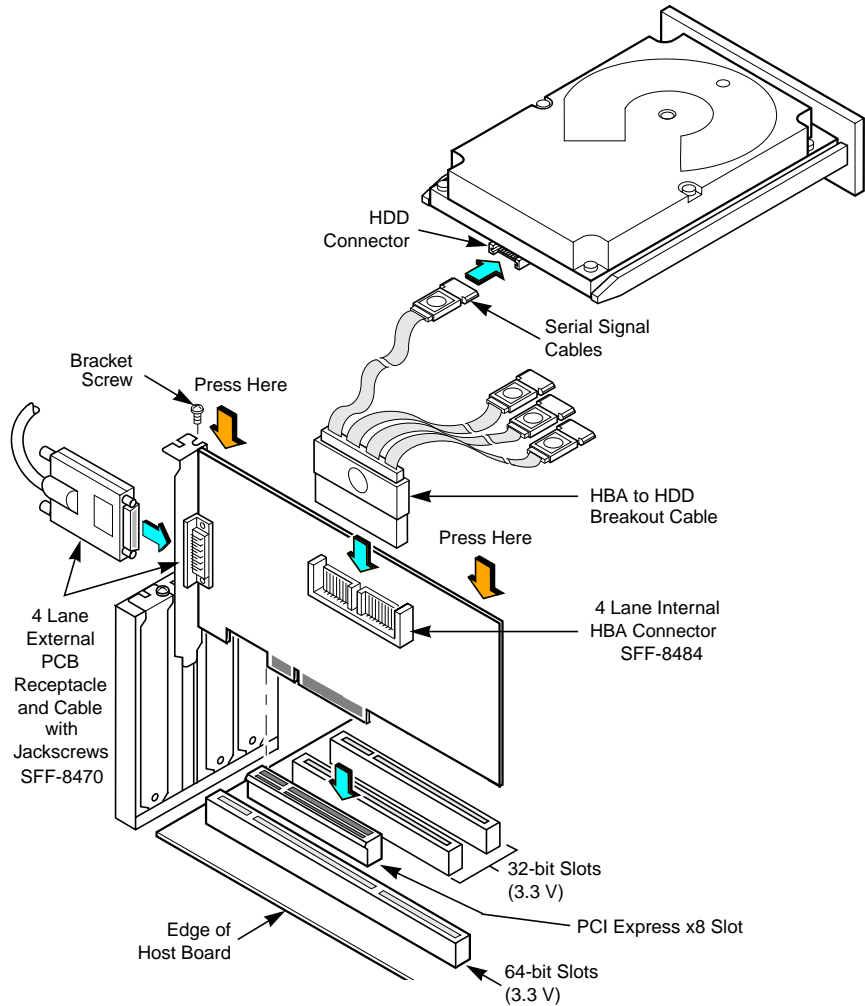

Note: The HBA shape, size, and locations of components on your x8 (or x4) HBA and its bracket may vary from this illustration. A PCI Express connector is smaller than a PCI/PCI-X connector.

Chapter 3

Host Adapter Characteristics

This chapter describes the characteristics of the LSI PCIe to 3.0 Gbit/s SAS host adapters. The chapter includes these topics:

- [Section 3.1, “Characteristics of the LSI PCIe to SAS Host Adapters”](#)
- [Section 3.2, “Electrical and Environmental Specifications”](#)

3.1 Characteristics of the LSI PCIe to SAS Host Adapters

The LSI PCIe to SAS host adapters use either the LSISAS1064E controller or the LSISAS1068E controller. The LSISAS1064E controller connects up to four SAS/SATA devices to a computer system through the PCI Express interface. The LSISAS1068E controller connects up to eight SAS/SATA devices to a computer system through the PCI Express interface. The LSI controllers are implemented using either four (LSISAS1064E) or eight (LSISAS1068E) PCI Express phys. Each phy operates at 2.5 Gbits/s which provide possible host-side maximum transmission and reception rates of up to 4.0 Gbytes/s.

The LSISAS1064E and the LSISAS1068E controller chips contain the PCI Express functionality for the LSI PCIe to SAS host adapters. The controller chip connects directly to the PCI Express bus and generates timing and protocol in compliance with the PCI Express specification.

The LSISAS1064E and the LSISAS1068E controller chips contain the SAS/SATA functionality for the LSI PCIe to SAS host adapters. The controller chips connect channels directly to the SAS/SATA devices.

The LSI PCIe to SAS host adapters provide a 2M x 8-bit Flash ROM for storing the BIOS and firmware. The LSI PCIe to SAS host adapters provide up to 32 K x 8-bit NVSRAM for storing the nonvolatile RAID information when a system failure happens. The LSISAS3442E,

LSISAS3442EL, LSISAS3443E, LSISAS3443EL, LSISAS3444E, LSISAS3444EL, LSISAS3800E, LSISAS3801E, and LSISAS3801EL host adapters provide a 128 K x 36-bit PDSRAM memory device for storing SAS Address Port information allowing for connection to more than 128 devices.

3.1.1 LSISAS3041E and LSISAS3041EL Host Adapters Characteristics

The LSISAS3041E and LSISAS3041EL are the same HBA with the exception of the PCI bracket. The LSISAS3041E uses a standard PCI bracket and the LSISAS3041EL uses the low-profile (LPPCI) PCI bracket. [Figure 3.1](#) shows the HBAs and their brackets.

3.1.1.1 LEDs

The LSISAS3041E and LSISAS3041EL host adapters have four LEDs, labeled A0–A3, that turn green to indicate an activity condition on any of the eight phys. There are eight LEDs, labeled LNPO–LNP3, that turn yellow to indicate a fault condition on any of the eight phys. See [Figure 3.1](#) for LED locations.

The LSISAS3041E and LSISAS3041EL host adapters have two light pipes routed through the PCI bracket. One light pipe turns green to indicate activity on any phy. The other light pipe is bi-color. It flashes green to indicate the LSISAS1064E heartbeat, or it turns yellow when the LSISAS1064E firmware detects a fault condition.

3.1.1.2 Connectors

This section provides a description of the five different connectors on the LSISAS3041E and LSISAS3041EL host adapters. See [Figure 3.1](#) for connector locations.

PCI Express Connector (J1) – The PCI Express interface has four PCI Express phys, which provide possible host-side maximum transmission and reception rates of up to 2.0 Gbytes/s. The PCI Express connection is made through the edge connector J1. The signal definitions and pin numbers conform to the PCI Express specifications.

SAS/SATA Connectors (J2, J5–J7) – The LSISAS3041E supports SAS/SATA connections through connectors J2, J5, J6, and J7. These connectors are SATA internal right-angle connectors.

Activity LED Header (J3) – 4-pin, right angle, 0.1-inch pitch, pin header for driving external activity LEDs.

Figure 3.1 LSISAS3041E and LSISAS3041EL Board Layout

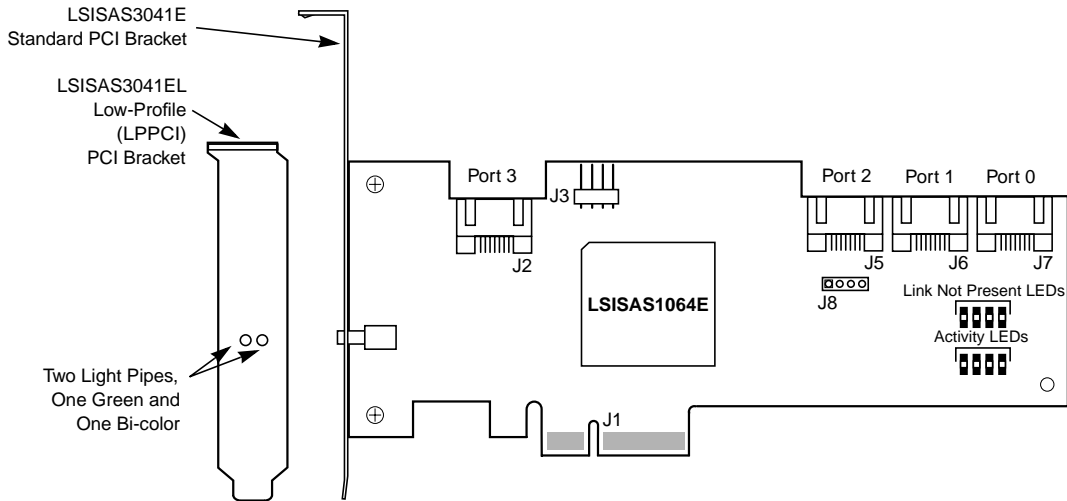

- J1: PCI Express x4 lane board edge connector
- J2, J5–J7: SATA internal right-angle connectors
- J3: 4-pin, right angle, 0.1" pitch, pin header for driving external activity LEDs

3.1.1.3 Physical Characteristics

The LSISAS3041E and LSISAS3041EL boards are 6.6 inches x 2.713 inches. PCI Express x4 connection is made through the edge connector J1. The component height on the top and bottom of the LSISAS3041E and LSISAS3041EL boards follows the PCI Express specifications.

3.1.2 LSISAS3080E and LSISAS3080EL Host Adapters Characteristics

The LSISAS3080E and LSISAS3080EL are identical HBAs with the exception of the PCI bracket. The LSISAS3080E uses a standard PCI bracket and the LSISAS3080EL uses a low-profile (LPPCI) PCI bracket. [Figure 3.2](#) shows the HBAs and their brackets.

3.1.2.1 LEDs

The LSISAS3080E and LSISAS3080EL host adapters have eight LEDs, labeled A0–A7, that turn green to indicate an activity condition on any of the eight phys. There are eight LEDs, labeled LNPO–LNP7, that turn yellow to indicate a fault condition on any of the eight phys. See [Figure 3.2](#) for LED locations.

The LSISAS3080E and LSISAS3080EL host adapters have two light pipes routed through the PCI bracket. One light pipe turns green to indicate activity on any phy. The other light pipe is bi-color. It flashes green to indicate the LSISAS1068E heartbeat, or it turns yellow when the LSISAS1068E firmware detects a fault condition.

3.1.2.2 Connectors

This section provides a description of the four different connectors on the LSISAS3080E and LSISAS3080EL host adapters. See [Figure 3.2](#) for connector locations.

PCI Express Connector (J1) – The PCI Express interface has eight PCI Express phys, which provide possible host-side maximum transmission and reception rates of up to 4.0 Gbytes/s. The LSISAS3080E or LSISAS3080EL supports x8, x4, and x1 PCI Express link widths, and automatically downshifts if plugged into either a x4 connector or into a x8 connector that is wired as a x4 connector. The PCI Express connection is made through the edge connector J1. The signal definitions and pin numbers conform to the PCI Express specifications.

SAS/SATA Connectors (J2 and J5) – The LSISAS3080E and LSISAS3080EL support SAS connections through connectors J2 and J3. The J2 and J3 connectors are SFF-8484 SAS internal right-angle connectors with four sideband lines.

Activity LED Header (J6) – 4-pin, right angle, 0.1-inch pitch, pin header for driving external activity LEDs.

Figure 3.2 LSISAS3080E and LSISAS3080EL Board Layout

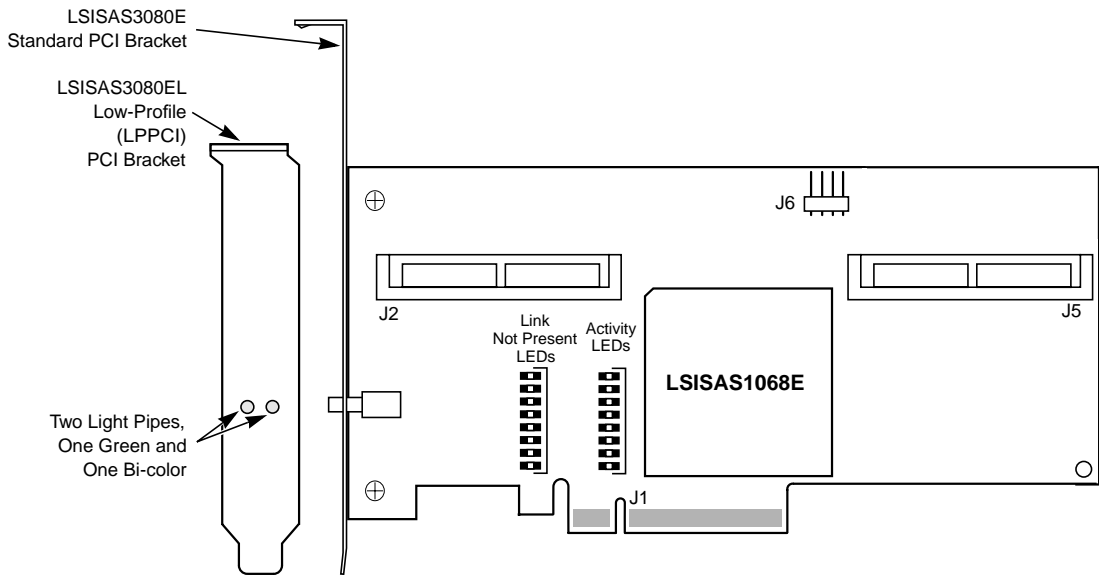

- J1: PCI Express x8 lane board edge connector
- J2, J5: SFF-8484 SAS internal right-angle connectors with four sideband lines
- J6: 4-pin, right angle, 0.1" pitch, pin header for driving external activity LED

3.1.2.3 Physical Characteristics

The LSISAS3080E and LSISAS3080EL boards are 6.3 inches x 2.713 inches. PCI Express connection is made through the edge connector J1. The component height on the top and bottom of the LSISAS3080E and LSISAS3080EL boards follows the PCI Express specifications.

3.1.3 LSISAS3081E and LSISAS3081EL Host Adapters Characteristics

The LSISAS3081E and LSISAS3081EL are identical HBAs with the exception of the PCI bracket. The LSISAS3081E uses a standard PCI bracket and the LSISAS3081EL uses a low-profile (LPPCI) PCI bracket. [Figure 3.3](#) shows the HBAs and their brackets.

3.1.3.1 LEDs

The LSISAS3081E and LSISAS3081EL host adapters have eight LEDs, labeled A0–A7, that turn green to indicate an activity condition on any of the eight phys. There are eight LEDs, labeled LNPO–LNP7, that turn yellow to indicate a fault condition on any of the eight phys. See [Figure 3.3](#) for LED locations.

The LSISAS3081E and LSISAS3081EL host adapters have two light pipes routed through the PCI bracket. One light pipe turns green to indicate activity on any phy. The other light pipe is bi-color. It flashes green to indicate the LSISAS1068E heartbeat, or it turns yellow when the LSISAS1068E firmware detects a fault condition.

3.1.3.2 Connectors

This section provides a description of the four different connectors on the LSISAS3081E and LSISAS3081EL host adapters. See [Figure 3.2](#) for connector locations.

PCI Express Connector (J1) – The PCI Express interface has eight PCI Express phys, which provide possible host-side maximum transmission and reception rates of up to 4.0 Gbytes/s. The LSISAS3081E or LSISAS3081EL supports x8, x4, and x1 PCI Express link widths, and automatically downshifts if plugged into either a x4 connector or into a x8 connector that is wired as a x4 connector. The PCI Express connection is made through the edge connector J1. The signal definitions and pin numbers conform to the PCI Express specifications.

SAS/SATA Connectors (J2 and J5) – The LSISAS3081E and LSISAS3081EL support SAS connections through connectors J2 and J5. The J2 and J5 connectors are SFF-8087 mini-SAS internal right-angle connectors.

Activity LED Header (J6) – 4-pin, right angle, 0.1-inch pitch, pin header for driving external activity LEDs.

Figure 3.3 LSISAS3081E and LSISAS3081EL Board Layout

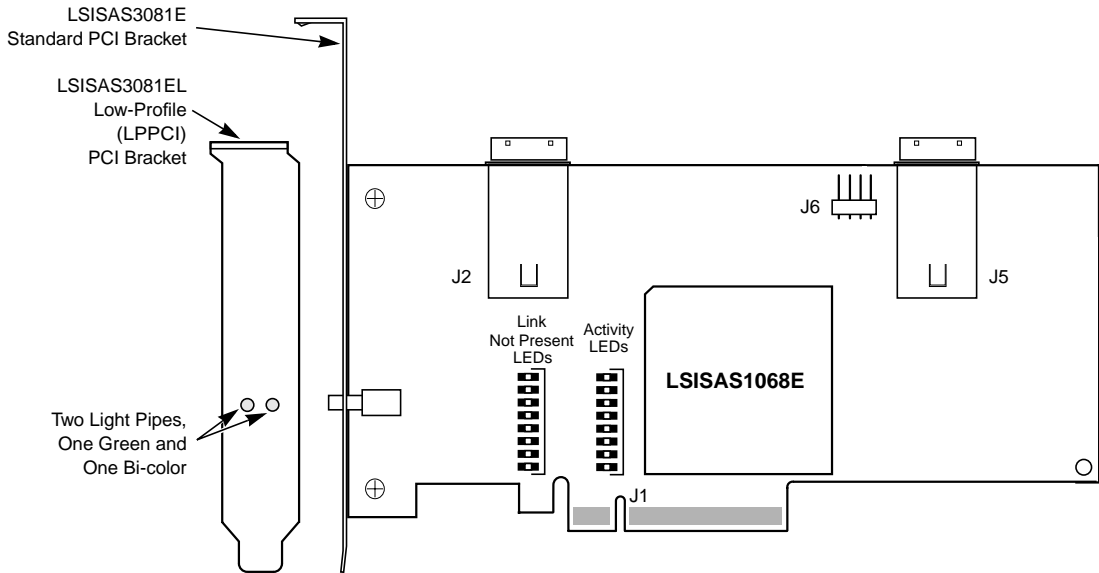

- J1: PCI Express x8 lane board edge connector
- J2, J5: SFF-8087 mini-SAS internal right-angle connectors
- J6: 4-pin, right angle, 0.1" pitch, pin header for driving external activity LED

3.1.3.3 Physical Characteristics

The LSISAS3081E and LSISAS3081EL boards are 6.6 inches x 2.713 inches. PCI Express connection is made through the edge connector J1. The component height on the top and bottom of the LSISAS3081E and LSISAS3081EL boards follows the PCI Express specifications.

3.1.4 LSISAS3442E and LSISAS3442EL Host Adapters Characteristics

The LSISAS3442E and LSISAS3442EL are the same HBA with the exception of the PCI bracket. The LSISAS3442E uses a standard PCI bracket and the LSISAS3442EL uses a low-profile (LPPCI) PCI bracket. [Figure 3.4](#) shows the HBAs and their brackets.

3.1.4.1 LEDs

The LSISAS3442E and LSISAS3442EL host adapters have eight LEDs, labeled A0–A7, that turn green to indicate an activity condition on any of the eight phys. There are eight LEDs, labeled LNPO–LNP7, that turn yellow to indicate a fault condition on any of the eight phys. See [Figure 3.4](#) for LED locations.

The LSISAS3442E and LSISAS3442EL host adapters have two light pipes routed through the PCI bracket. One light pipe turns green to indicate activity on any phy. The other light pipe is bi-color. It flashes green to indicate the LSISAS1068E heartbeat, or it turns yellow when the LSISAS1068E firmware detects a fault condition.

3.1.4.2 Connectors

This section provides a description of the four different connectors on the LSISAS3442E and LSISAS3442EL host adapters. See [Figure 3.4](#) for connector locations.

PCI Express Connector (J1) – The PCI Express interface has eight PCI Express phys, which provide possible host-side maximum transmission and reception rates of up to 4.0 Gbytes/s. The LSISAS3442E or LSISAS3442EL supports x8, x4, and x1 PCI Express link widths, and automatically downshifts if plugged into either a x4 connector or into a x8 connector that is wired as a x4 connector. The connection is made through the edge connector J1. The signal definitions and pin numbers conform to the PCI Express specifications.

SAS/SATA Connectors (J2 and J5) – The LSISAS3442E and LSISAS3442EL support SAS connections through connectors J2 and J5. The J5 connector is an SFF-8484 SAS internal right-angle connector with four sideband lines. The J2 connector is an SFF-8470 SAS external right-angle connector.

Activity LED Header (J6) – 4-pin, right angle, 0.1-inch pitch, pin header for driving external activity LEDs.

Figure 3.4 LSISAS3442E and LSISAS3442EL Board Layout

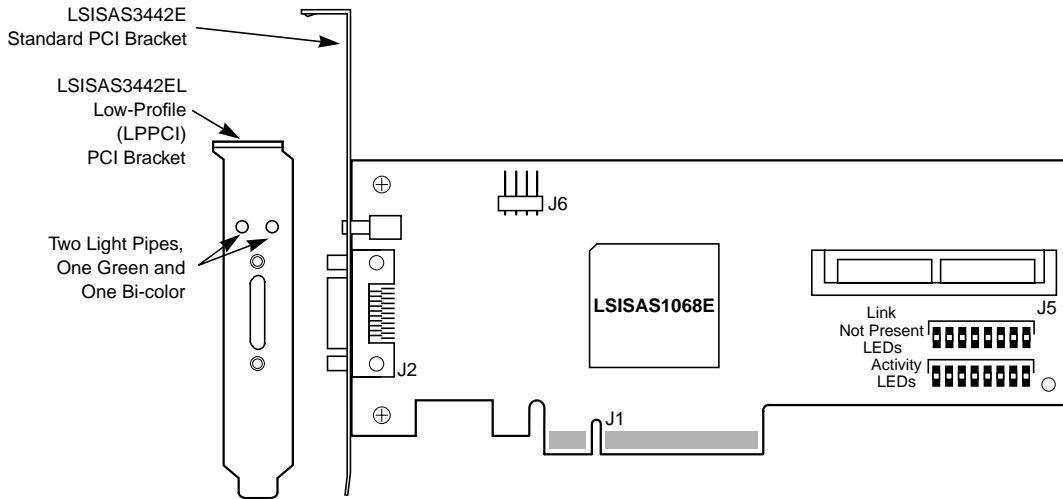

- J1: PCI Express x8 lane board edge connector
- J2: SFF-8470 SAS external right-angle connector
- J5: SFF-8484 SAS internal right-angle connector with four sideband lines
- J6: 4-pin, right angle, 0.1" pitch, pin header for driving external activity LED

3.1.4.3 Physical Characteristics

The LSISAS3442E and LSISAS3442EL boards are 6.6 inches x 2.713 inches. PCI Express x8 connection is made through the edge connector J1. The component height on the top and bottom of the LSISAS3442E and LSISAS3442EL boards follows the PCI Express specifications.

3.1.5 LSISAS3443E and LSISAS3443EL Host Adapters Characteristics

The LSISAS3443E and LSISAS3443EL are the same HBA with the exception of the PCI bracket. The LSISAS3443E uses a standard PCI bracket and the LSISAS3443EL uses a low-profile (LPPCI) PCI bracket. [Figure 3.5](#) shows the HBAs and their brackets.

3.1.5.1 LEDs

The LSISAS3443E and LSISAS3443EL host adapters have eight LEDs, labeled A0–A7, that turn green to indicate an activity condition on any of the eight phys. There are eight LEDs, labeled LNPO–LNP7, that turn yellow to indicate a fault condition on any of the eight phys. See [Figure 3.5](#) for LED locations.

The LSISAS3443E and LSISAS3443EL host adapters have two light pipes routed through the PCI bracket. One light pipe turns green to indicate activity on any phy. The other light pipe is bi-color. It flashes green to indicate the LSISAS1068E heartbeat, or it turns yellow when the LSISAS1068E firmware detects a fault condition.

3.1.5.2 Connectors

This section provides a description of the four different connectors on the LSISAS3443E and LSISAS3443EL host adapters. See [Figure 3.5](#) for connector locations.

PCI Express Connector (J1) – The PCI Express interface has eight PCI Express phys, which provide possible host-side maximum transmission and reception rates of up to 4.0 Gbytes/s. The LSISAS3443E or LSISAS3443EL supports x8, x4, and x1 PCI Express link widths, and automatically downshifts if plugged into either a x4 connector or into a x8 connector that is wired as a x4 connector. The connection is made through the edge connector J1. The signal definitions and pin numbers conform to the PCI Express specifications.

SAS/SATA Connectors (J2 and J5) – The LSISAS3443E and LSISAS3443EL support SAS connections through connectors J2 and J5. The J2 connector is an SFF-8088 mini-SAS external connector. The J5 connector is an SFF-8087 mini-SAS internal connector.

Activity LED Header (J6) – 4-pin, right angle, 0.1-inch pitch, pin header for driving external activity LEDs.

Figure 3.5 LSISAS3443E and LSISAS3443EL Board Layout

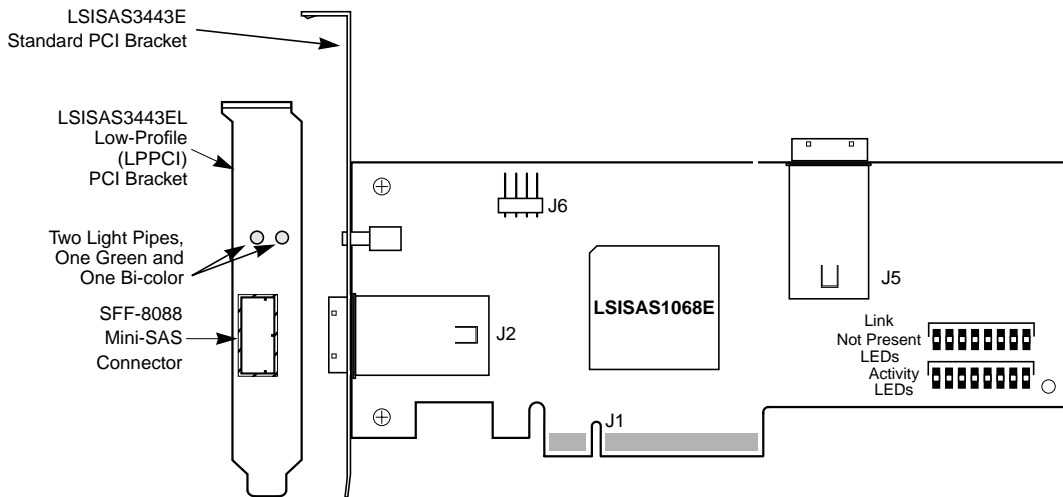

- J1: PCI Express x8 lane board edge connector
- J2: SFF-8088 mini-SAS external right-angle connector
- J5: SFF-8087 mini-SAS internal right-angle connector with four sideband lines
- J6: 4-pin, right angle, 0.1" pitch, pin header for driving external activity LED

3.1.5.3 Physical Characteristics

The LSISAS3443E and LSISAS3443EL boards are 6.6 inches x 2.713 inches. PCI Express x8 connection is made through the edge connector J1. The component height on the top and bottom of the LSISAS3443E and LSISAS3443EL boards follows the PCI Express specifications.

3.1.6 LSISAS3444E and LSISAS3444EL Host Adapters Characteristics

The LSISAS3444E and LSISAS3444EL are the same HBA with the exception of the PCI bracket. The LSISAS3444E uses a standard PCI bracket and the LSISAS3444EL uses a low-profile (LPPCI) PCI bracket. [Figure 3.6](#) shows the HBAs and their brackets.

3.1.6.1 LEDs

The LSISAS3444E and LSISAS3444EL host adapters have eight LEDs, labeled A0–A7, that turn green to indicate an activity condition on any of the eight phys. There are eight LEDs, labeled LNPO–LNP7, that turn yellow to indicate a fault condition on any of the eight phys. See [Figure 3.6](#) for LED locations.

The LSISAS3444E and LSISAS3444EL host adapters have two light pipes routed through the PCI bracket. One light pipe turns green to indicate activity on any phy. The other light pipe is bi-color. It flashes green to indicate the LSISAS1068E heartbeat, or it turns yellow when the LSISAS1068E firmware detects a fault condition.

3.1.6.2 Connectors

This section provides a description of the seven different connectors on the LSISAS3444E and LSISAS3444EL host adapters. See [Figure 3.6](#) for connector locations.

PCI Express Connector (J1) – The PCI Express interface has eight PCI Express phys, which provide possible host-side maximum transmission and reception rates of up to 4.0 Gbytes/s. The LSISAS3444E or LSISAS3444EL supports x8, x4, and x1 PCI Express link widths, and automatically downshifts if plugged into either a x4 connector or into a x8 connector that is wired as a x4 connector. The connection is made through the edge connector J1. The signal definitions and pin numbers conform to the PCI Express specifications.

SAS/SATA Connectors (J2 and J3, J6–J8) – The LSISAS3444E and LSISAS3444EL support SAS connections through these connectors. The J3 and J6–J8 connectors are SATA internal latching right-angle connectors. The J2 connector is an SFF-8088 mini-SAS external right-angle connector.

Activity LED Header (J9) – 4-pin, right angle, 0.1-inch pitch, pin header for driving external activity LEDs.

Figure 3.6 LSISAS3444E and LSISAS3444EL Board Layout

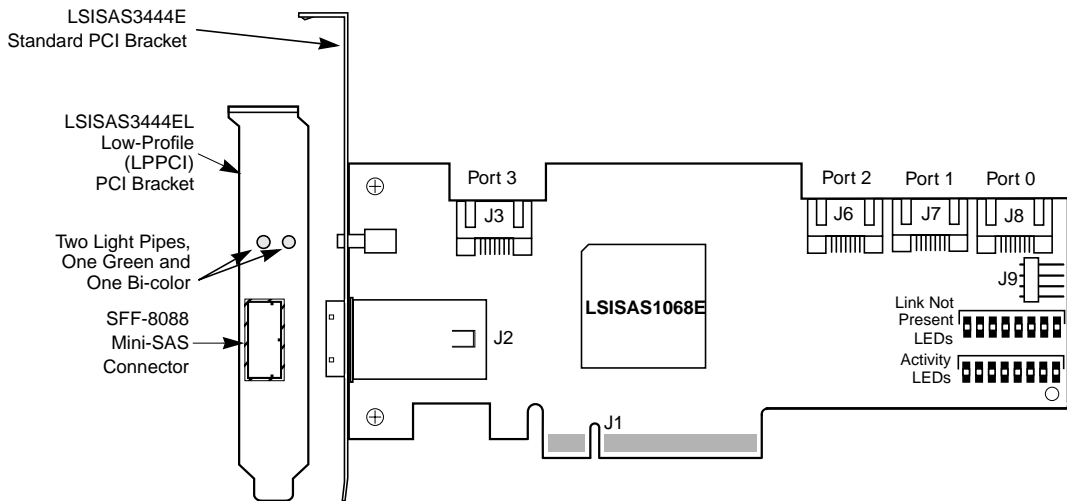

- J1: PCI Express x8 lane board edge connector
- J2: SFF-8088 mini-SAS external right-angle connector
- J3, J6–J8: SATA internal latching right-angle connectors
- J9: 4-pin, right angle, 0.1" pitch, pin header for driving external activity LED

3.1.6.3 Physical Characteristics

The LSISAS3444E and LSISAS3444EL boards are 6.6 inches x 2.713 inches. PCI Express x8 connection is made through the edge connector J1. The component height on the top and bottom of the LSISAS3444E and LSISAS3444EL boards follows the PCI Express specifications.

3.1.7 LSISAS3800E Host Adapter Characteristics

The LSISAS3800E uses a standard PCI bracket. [Figure 3.7](#) shows the HBA and its bracket.

3.1.7.1 LEDs

The LSISAS3800E host adapter has eight LEDs, labeled A0–A7, that turn green to indicate an activity condition on any of the eight phys. There are eight LEDs, labeled LNP0–LNP7, that turn yellow to indicate a fault condition on any of the eight phys. See [Figure 3.7](#) for LED locations.

The LSISAS3800E host adapter has two light pipes routed through the PCI bracket. One light pipe turns green to indicate activity on any phy. The other light pipe is bi-color. It flashes green to indicate the LSISAS1068E heartbeat, or it turns yellow when the LSISAS1068E firmware detects a fault condition.

3.1.7.2 Connectors

This section provides a description of the four different connectors on the LSISAS3800E host adapter. See [Figure 3.7](#) for connector locations.

PCI Express Connector (J1) – The PCI Express interface has eight PCI Express phys, which provide possible host-side maximum transmission and reception rates of up to 4.0 Gbytes/s. The LSISAS3800E supports x8, x4, and x1 PCI Express link widths, and automatically downshifts if plugged into either a x4 connector or into a x8 connector that is wired as a x4 connector. The connection is made through the edge connector J1. The signal definitions and pin numbers conform to the PCI Express specifications.

SAS/SATA Connectors (J2 and J3) – The LSISAS3800E supports SAS/SATA connections through connectors J2 and J3. The J2 and J3 connectors are SFF-8470 SAS external right-angle connectors.

Activity LED Header (J4) – 4-pin, right angle, 0.1-inch pitch, pin header for driving external activity LEDs.

Figure 3.7 LSISAS3800E Board Layout

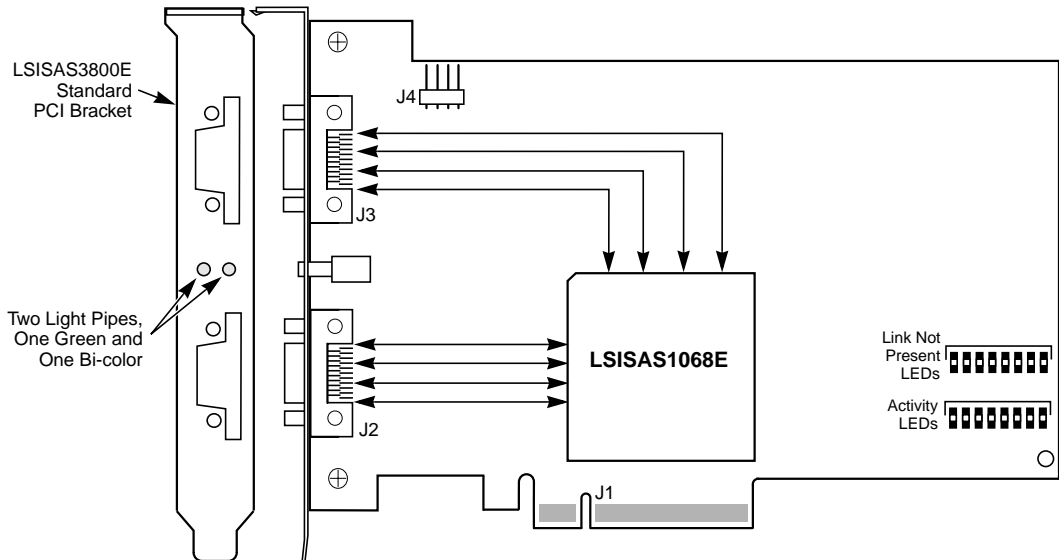

- J1: PCI Express x8 lane board edge connector
- J2 and J3: SFF-8470 SAS external right-angle connector
- J4: 4-pin, right angle, 0.1" pitch, pin header for driving external activity LED

3.1.7.3 Physical Characteristics

The LSISAS3800E is 6.6 inches x 4.375 inches. PCI Express connection is made through the edge connector J1. The component height on the top and bottom of the LSISAS3800E board follows the PCI Express specifications.

3.1.8 LSISAS3801E and LSISAS3801EL Host Adapters Characteristics

The LSISAS3801E and LSISAS3801EL are the same HBA with the exception of the PCI bracket. The LSISAS3801E uses a standard PCI bracket and the LSISAS3801EL uses a low-profile (LPPCI) PCI bracket. [Figure 3.8](#) shows the HBAs and their brackets.

3.1.8.1 LEDs

The LSISAS3801E and LSISAS3801EL host adapters have eight LEDs, labeled A0–A7, that turn green to indicate an activity condition on any of the eight phys. There are also eight LEDs, labeled LNP0–LNP7, that turn yellow to indicate a fault condition on any of the eight phys. See [Figure 3.8](#) for LED locations.

The LSISAS3801E and LSISAS3801EL host adapters contain two additional LEDs. One LED turns green to indicate activity on any phy. The other LED is bi-color. It flashes green to indicate the LSISAS1068E heartbeat, or it turns yellow when the LSISAS1068E firmware detects a fault condition.

3.1.8.2 Connectors

This section provides a description of the four different types of connectors on the LSISAS3801E and LSISAS3801EL host adapters. See [Figure 3.8](#) for connector locations.

PCI Express Connector (J1) – The PCI Express interface has eight PCI Express phys, which provide possible host-side maximum transmission and reception rates of up to 4.0 Gbytes/s. The LSISAS3801E or LSISAS3801EL supports x8, x4, and x1 PCI Express link widths, and automatically downshifts if plugged into either a x4 connector or into a x8 connector that is wired as a x4 connector. The connection is made through the edge connector J1. The signal definitions and pin numbers conform to the PCI Express specifications.

SAS/SATA Connectors (J2 and J3) – The LSISAS3801E and LSISAS3801EL support SAS connections through connectors J2 and J3. These connectors are SFF-8088 mini-SAS external right-angle connectors.

Activity LED Header (J4) – 4-pin, right angle, 0.1-inch pitch, pin header for driving external activity LEDs.

Figure 3.8 LSISAS3801E and LSISAS3801EL Board Layout

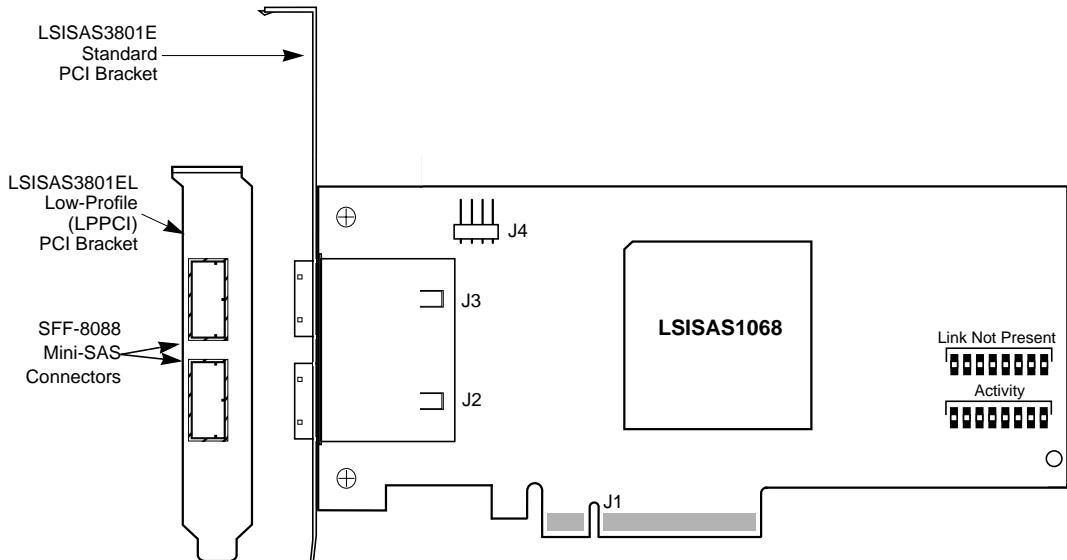

- J1: PCI Express x8 lane board edge connector
- J2 and J3: SFF-8088 mini-SAS external right-angle connectors
- J4: 4-pin, right angle, 0.1" pitch, pin header for driving external activity LED

3.1.8.3 Physical Characteristics

The LSISAS3801E and LSISAS3801EL boards are 6.6 inches x 2.713 inches. PCI Express x8 connection is made through the edge connector J1. The component height on the top and bottom of the LSISAS3801E and LSISAS3801EL boards follows the PCI Express specifications.

3.2 Electrical and Environmental Specifications

The design and implementation of the LSI PCIe to SAS host adapters minimize electromagnetic emissions, susceptibility to radio frequency energy, and the effects of electrostatic discharge. The board carries the CE mark, C-Tick mark, Canadian Compliance Statement, Korean MIC, Taiwan BSMI, Japan VCCI, FCC Class B and is marked with the FCC Self-Certification logo. The board also meets the requirements of CISPR Class B.

3.2.1 Electrical Characteristics

Table 3.1 lists the maximum power requirements for the LSI PCIe to SAS host adapters under normal operation.

Table 3.1 Maximum Power Requirements

Host Adapters	PCI Express +12.0 V	Power	Operating Range
LSISAS3041E, LSISAS3041EL	0.5 A	6.0 W	0 °C to 60 °C
LSISAS3080E, LSISAS3080EL	0.5 A	6.0 W	0 °C to 60 °C
LSISAS3081E, LSISAS3081EL	0.5 A	6.0 W	0 °C to 60 °C
LSISAS3442E, LSISAS3442EL	0.5 A	6.0 W	0 °C to 60 °C
LSISAS3443E, LSISAS3443EL	0.5 A	6.0 W	0 °C to 60 °C
LSISAS3444E, LSISAS3444EL	0.5 A	6.0 W	0 °C to 60 °C
LSISAS3800E	0.5 A	6.0 W	0 °C to 60 °C
LSISAS3801E, LSISAS3801EL	0.5 A	6.0 W	0 °C to 60 °C

3.2.2 Thermal and Atmospheric Characteristics

The atmospheric characteristics for the LSI PCIe to SAS host adapters are:

- Temperature range: 0 °C to 60 °C (dry bulb)
- Relative humidity range: 5% to 90% non-condensing
- Maximum dew point temperature: 32 °C

The following parameters define the storage and transit environment for the LSI PCIe to SAS host adapters:

- Temperature range: -45 °C to +105 °C (dry bulb)
- Relative humidity range: 5% to 90% non-condensing

3.2.3 Safety Characteristics

All LSI PCIe to SAS host adapters meet or exceed the requirements of UL flammability rating 94V-0. Each bare board is marked with the supplier's name or trademark, type, and UL flammability rating. Because these boards are installed in a PCI Express bus slot, all voltages are below the SELV 42.4 V limit.

Customer Feedback

We would appreciate your feedback on this document. Please copy the following page, add your comments, and fax it to us at the number shown.

If appropriate, please also fax copies of any marked-up pages from this document.

Important: Please include your name, phone number, fax number, and company address so that we may contact you directly for clarification or additional information.

Thank you for your help in improving the quality of our documents.

Reader's Comments

Fax your comments to: LSI Logic Corporation
Technical Publications
M/S AF-198
Fax: 408.433.4333

Please tell us how you rate this document: *PCIe to 3.0 Gbit/s SAS Host Adapters User's Guide*. Place a check mark in the appropriate blank for each category.

	Excellent	Good	Average	Fair	Poor
Completeness of information	___	___	___	___	___
Clarity of information	___	___	___	___	___
Ease of finding information	___	___	___	___	___
Technical content	___	___	___	___	___
Usefulness of examples and illustrations	___	___	___	___	___
Overall manual	___	___	___	___	___

What could we do to improve this document?

If you found errors in this document, please specify the error and page number. If appropriate, please fax a marked-up copy of the page(s).

Please complete the information below so that we may contact you directly for clarification or additional information.

Name _____ Date _____

Telephone _____ Fax _____

Title _____

Department _____ Mail Stop _____

Company Name _____

Street _____

City, State, Zip _____

Customer Feedback

Free Manuals Download Website

<http://myh66.com>

<http://usermanuals.us>

<http://www.somanuals.com>

<http://www.4manuals.cc>

<http://www.manual-lib.com>

<http://www.404manual.com>

<http://www.luxmanual.com>

<http://aubethermostatmanual.com>

Golf course search by state

<http://golfingnear.com>

Email search by domain

<http://emailbydomain.com>

Auto manuals search

<http://auto.somanuals.com>

TV manuals search

<http://tv.somanuals.com>