

DXS-54/EC

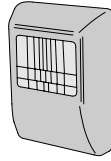

SUPERVISED WIRELESS MOTION DETECTOR



Installation Instructions

Linear

(760) 438-7000 • FAX (760) 438-7043
www.linearcorp.com

PRODUCT DESCRIPTION

The DXS-54/EC is a battery powered passive infrared motion detector with a built-in transmitter designed for use with Linear's DXS and DX format receivers. This transmitter can be used in a variety of motion detection applications. When the passive infrared sensor detects motion in its field of view, the transmitter sends a digitally coded wireless signal to its companion receiver.

The digital DXS code format features over a million possible codes. The DXS transmitters are precoded at the factory to unique codes, so no field coding is required. The DXS-54/EC can send three different signals: alarm, low battery and status.

For versatility, any transmitter can be programmed into any receiver channel. Receivers must be programmed to the transmitter's code before system testing and operation. Refer to the receiver's instructions for details on programming.

In a typical installation, the motion detector is mounted indoors in a corner or on a wall between six and eight feet high. The sensor will monitor the infrared level in its detection pattern. If the level increases or decreases rapidly (as when a person or animal moves through the area) the transmitter triggers, sending an alarm signal to the receiver.

The unit is powered from a 9-Volt alkaline battery. The battery's life can be up to three years depending on the area's traffic. When the battery gets low, the test indicator will flash and a low battery signal will be sent to the receiver when the detector senses motion.

Approximately every hour, the DXS-54/EC will send a status transmission to the receiver. The hourly signal updates the receiver to the transmitter's condition. By monitoring status transmissions, the receiver can determine if a transmitter has a low battery or has been removed from the system. DXS format receivers can monitor status signals, DX format receivers cannot.

To conserve battery life, during normal operation, the detector can trigger the transmitter a maximum of once every four minutes.

For setup and testing, pressing the detector's test button places the unit in walk test mode for four minutes. The installer can walk in front of the unit while viewing the red test indicator through the detector's lens to determine the detection area.

In walk test, an alarm signal is sent each time the walk test indicator lights. During normal operation, the detector requires a "pulse count" of three events in eight seconds before sending an alarm transmission.

DXS-54/EC FEATURES

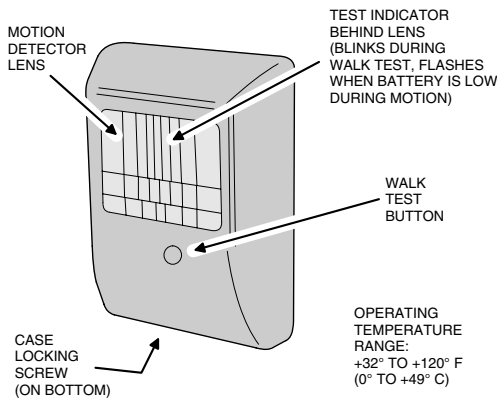

DETECTION PATTERN

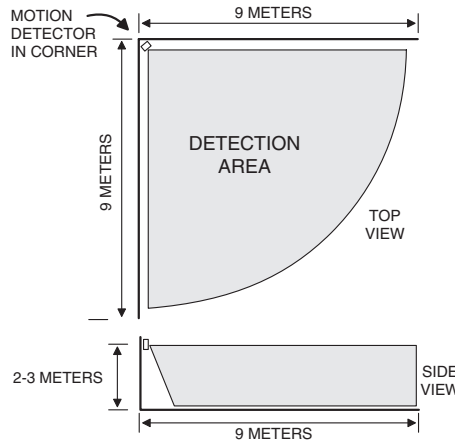

TYPICAL INSTALLATION

DON'T POINT AT HEAT SOURCES (HEATERS, ETC.), WINDOWS, OTHER MOTION DETECTORS OR DOOR/WINDOW TRANSMITTERS

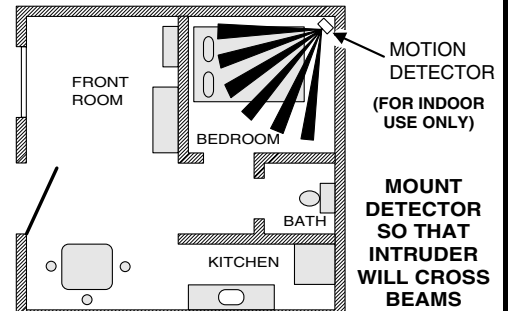

CONNECTING BATTERY

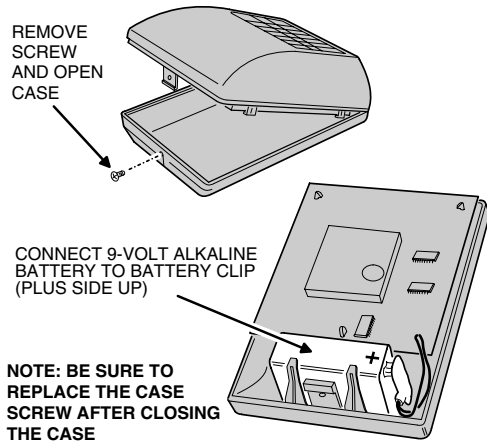

MOUNTING DETECTOR BASE

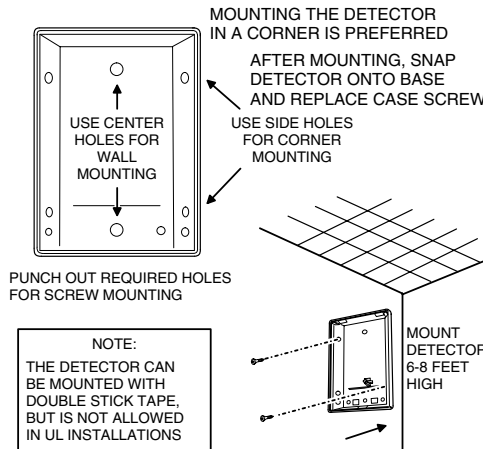

WALK TEST

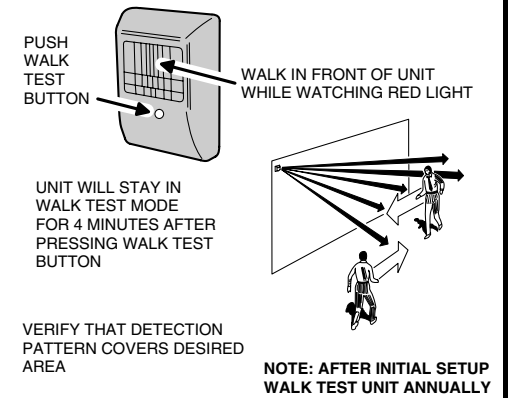

PROGRAM RECEIVER AND TEST

FOR PROGRAMMING, REFER TO THE RECEIVER'S INSTRUCTIONS

AFTER PROGRAMMING RECEIVER TO THE TRANSMITTER'S CODE TEST THE SYSTEM

STAYING CLEAR, WAIT AT LEAST FIVE MINUTES BEFORE WALKING INTO THE DETECTION AREA

WALK ACROSS THE DETECTION PATTERN AND VERIFY THAT THE RECEIVER ACTIVATES

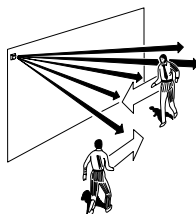
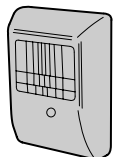

CHANGING BATTERY

WHEN THE DETECTOR HAS A LOW BATTERY:

REMOVE SCREW AND OPEN CASE

REPLACE THE BATTERY WITH A FRESH 9-VOLT ALKALINE OR LITHIUM BATTERY (PLUS SIDE UP)

USE ALKALINE OR LITHIUM BATTERIES ONLY

SNAP DETECTOR ONTO BASE AND REPLACE CASE SCREW WHEN FINISHED

R&TTE VAAE 27807, EMC, SFT, ETS

Linear Corporation declares that the apparatus DXS-54/EC complies with the essential requirements and other relevant provisions of Directive 1995/5/EC.

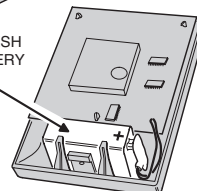
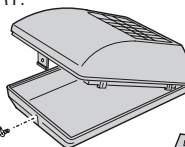

INTERNATIONAL WARRANTY

This Linear product is warranted against defects in material and workmanship for twelve (12) months. The Warranty Expiration Date is labeled on the product. This warranty extends only to wholesale customers who buy direct from Linear or through Linear's normal distribution channels. Linear does not warrant this product to consumers. Consumers should inquire from their selling dealer as to the nature of the dealer's warranty, if any. There are no obligations or liabilities on the part of Linear Corporation for consequential damages arising out of or in connection with use or performance of this product or other indirect damages with respect to loss of property, revenue, or profit, or cost of removal, installation, or reinstallation. All implied warranties, including implied warranties for merchantability and implied warranties for fitness, are valid only until Warranty Expiration Date as labeled on the product. This Linear Corporation Warranty is in lieu of all other warranties express or implied. For warranty service on Linear equipment return product, at sender's expense to:

Linear Hong Kong 19/F Hounor Industrial Centre, 6 Sun Yip Street Choi Wan, Hong Kong
Attention: Repairs Department

REPAIRS POLICY

Charges will be made for equipment that is not in warranty, shows customer abuse, or is damaged by the effects of lightning, water, fire, or other abnormal happenings. Customer's equipment sent for repair may be repaired or replaced with new or remanufactured equipment at Linear's discretion.

The customer is always responsible for shipping and handling charges to the repairs facility. Linear will pay return shipping and handling charges on "in warranty" products shipped back to the customer. The customer will be billed for the return shipping and handling charges on "out of warranty" products. There will be a 50% expedite fee for any express requests.

The International Sales Manager must be notified prior to the return of product to Linear. All international returns must have an International Repair Authorization number (IRAs). The number must be marked on all packages. Failure to do so will cause delays in processing.

IMPORTANT!!!

Linear radio controls provide a reliable communications link and fill an important need in portable wireless signaling. However, there are some limitations which must be observed. The radios are required to comply with local rules and regulations as radio devices. As such, they have limited transmitter power and therefore limited range. A receiver cannot respond to more than one transmitted signal at a time and may be blocked by radio signals that occur on or near their operating frequencies, regardless of code settings. Changes or modifications to the device may void regulatory compliance. Infrequently used radio links should be tested regularly to protect against undetected interference or fault. A general knowledge of radio and its vagaries should be gained prior to acting as a wholesale distributor or dealer, and these facts should be communicated to the ultimate users.

Free Manuals Download Website

<http://myh66.com>

<http://usermanuals.us>

<http://www.somanuals.com>

<http://www.4manuals.cc>

<http://www.manual-lib.com>

<http://www.404manual.com>

<http://www.luxmanual.com>

<http://aubethermostatmanual.com>

Golf course search by state

<http://golfingnear.com>

Email search by domain

<http://emailbydomain.com>

Auto manuals search

<http://auto.somanuals.com>

TV manuals search

<http://tv.somanuals.com>