

VB-2 & VB-3

AUDIO MODULES

With 2-way Central Station Audio (VB-2 only)

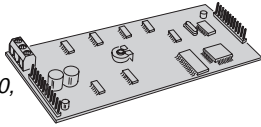

For Use With DVS-1200, DVS-2400, DVS-2408, Security Systems

Installation Instructions

Linear

(760) 438-7000 • FAX (760) 438-7043
USA & Canada (800) 421-1587 & (800) 392-0123
Toll Free FAX (800) 468-1340

PRODUCT DESCRIPTION

The VB-2 and VB-3 Audio Modules are designed as add-on accessories for the DVS-1200, DVS-2400, and DVS-2408 Security Systems. Each module plugs directly into the unit's circuit board. The modules provide voice prompts for operating the system and voice feedback for remote command of the system through a pushbutton telephone. The VB-2 module features 2-way audio and audio listen-only capabilities for Central Station monitoring.

The digitally synthesized human voice produced by the module announces important system information through the Console's speaker or through a remote speaker. Both modules are pre-programmed with a multi-word vocabulary. Each time the system's mode is changed, the voice module will sound the status of the Console and its sensors. The volume control adjusts the voice level.

With either the VB-2 or VB-3 installed, and the Console connected to a telephone line, local or off-site telephone sets can be used to control and interrogate the DVS-2400 or DVS-2408. To gain access to the system, the user first enters their user code. The module's voice will then prompt the user to press various telephone buttons to control the system. The DVS-1200 can be accessed only from off-site telephones.

The VB-2 module supports 2-way audio communications with the Central Station. The small microphone supplied fits into the Console's case. The microphone's high-gain amplifier allows the Central Station to monitor the sounds in the installation. The Central Station operator can control the direction of the 2-way communications using a pushbutton telephone. In 2-way mode, the operator can talk back to the subscriber through the Console's speaker or a remote speaker.

1. COMPONENT LOCATIONS

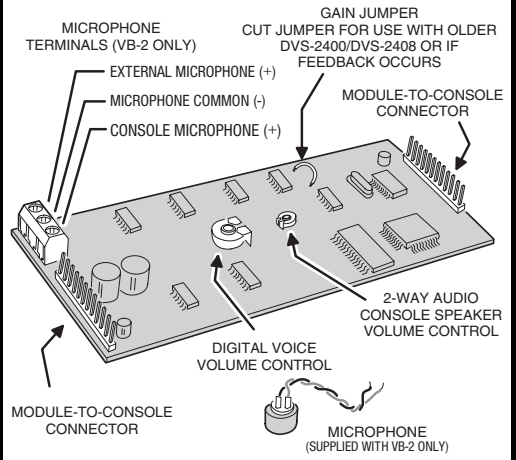

2. CONNECT MICROPHONE

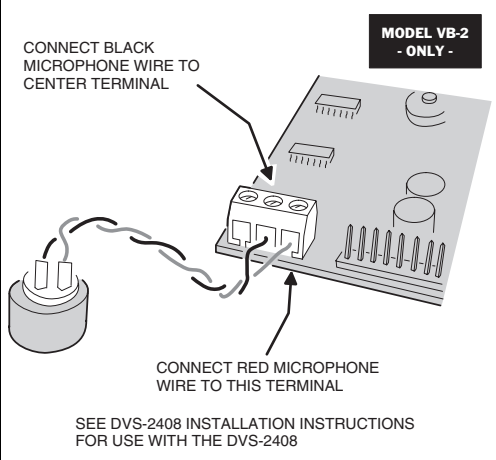

3. PLUG MODULE INTO CIRCUIT BOARD

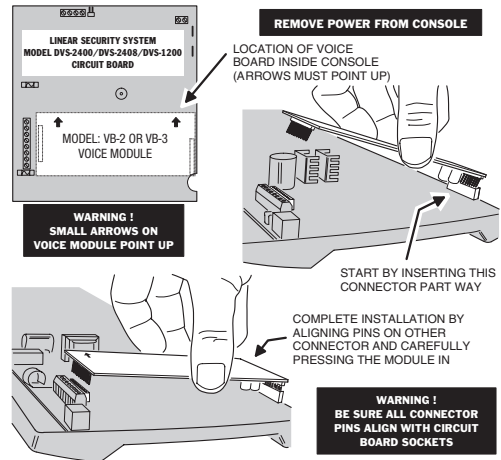

4. MOUNT MICROPHONE

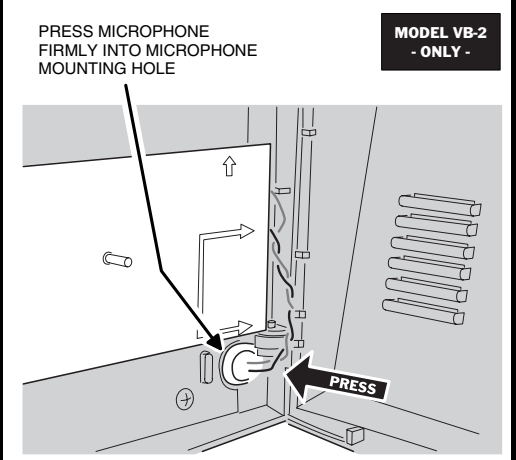

5. REMOTE SPEAKER & MICROPHONE

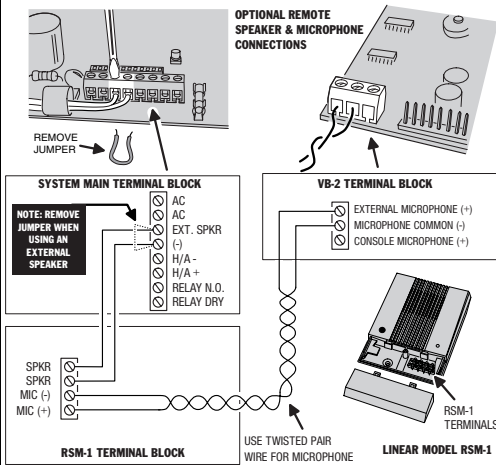

6. VOICE SYNTHESIS SETUP

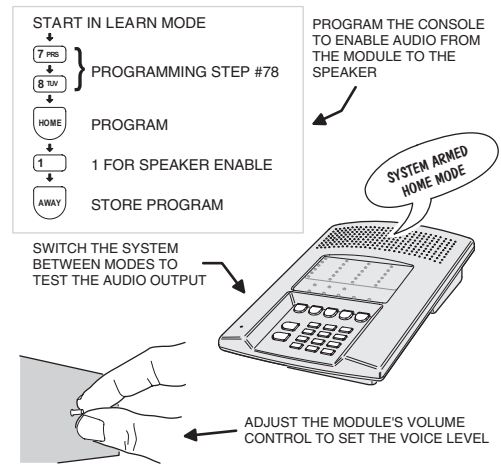

7. REMOTE SYSTEM OPERATION

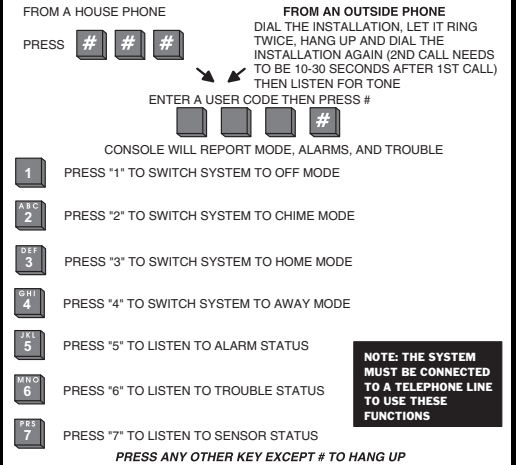

8. CENTRAL STATION AUDIO (VB-2 ONLY)

PROGRAM THE SYSTEM FOR THE DESIRED AUDIO MODE

START IN LEARN MODE

7 PRS } PROGRAMMING STEP #78
6 MNO }
HOME PROGRAM

0 FOR NO AUDIO MONITORING
1 FOR LISTEN-ONLY
2 FOR 2-WAY MANUAL
3 FOR 2-WAY FULL DUPLEX

AWAY STORE PROGRAM

AFTER THE ALARM REPORT IS SENT THE SYSTEM WILL SWITCH TO THE PROGRAMMED AUDIO MODE FOR 90 SECONDS

CENTRAL STATION OPERATOR: USE THESE KEYS ON A TELEPHONE SET CONNECTED TO THE COMMUNICATOR LINE TO CONTROL THE AUDIO MODULE

MODEL VB-2 - ONLY -

ALL AUDIO MODES { WXY 9 PRESS "9" TO DISCONNECT THE CALL

2-WAY MANUAL AUDIO MODE { DEF 3 PRESS "3" TO LISTEN

1 PRESS "1" TO TALK

THE "1" AND "3" KEYS ARE NOT USED IN LISTEN-ONLY AUDIO MODE

THE "1" AND "3" KEYS CAN BE USED IN FULL DUPLEX MODE, ALTHOUGH THE MODULE WILL SWITCH TO 2-WAY MANUAL MODE UNTIL THE NEXT CALL

PRESSING ANY OTHER KEY WILL EXTEND THE AUDIO TIME 90 SECONDS

LINEAR LIMITED WARRANTY

This Linear product is warranted against defects in material and workmanship for twelve (12) months. The Warranty Expiration Date is labeled on the product. This warranty extends only to wholesale customers who buy direct from Linear or through Linear's normal distribution channels. Linear does not warrant this product to consumers. Consumers should inquire from their selling dealer as to the nature of the dealer's warranty, if any. There are no obligations or liabilities on the part of Linear corporation for consequential damages arising out of or in connection with use or performance of this product or other indirect damages with respect to loss of property, revenue, or profit, or cost of removal, installation, or reinstallation. All implied warranties, including implied warranties for merchantability and implied warranties for fitness, are valid only until Warranty Expiration Date as labeled on the product. This Linear Corporation Warranty is in lieu of all other warranties express or implied.

All products returned for warranty service require a Return Product Authorization Number (RPA#). Contact Linear Technical Service at 1-800-421-1587 for an RPA# and other important details.

IMPORTANT!!!

Linear radio controls provide a reliable communications link and fill an important need in portable wireless signaling. However, there are some limitations which must be observed.

- * For U.S. installations only: The radios are required to comply with FCC Rules and Regulations as Part 15 devices. As such, they have limited transmitter power and therefore limited range.
- * A receiver cannot respond to more than one transmitted signal at a time and may be blocked by radio signals that occur on or near their operating frequencies, regardless of code settings.
- * Changes or modifications to the device may void FCC compliance.
- * Infrequently used radio links should be tested regularly to protect against undetected interference or fault.
- * A general knowledge of radio and its vagaries should be gained prior to acting as a wholesale distributor or dealer, and these facts should be communicated to the ultimate users.

Copyright © 1999 Linear Corporation 214074 B

Free Manuals Download Website

<http://myh66.com>

<http://usermanuals.us>

<http://www.somanuals.com>

<http://www.4manuals.cc>

<http://www.manual-lib.com>

<http://www.404manual.com>

<http://www.luxmanual.com>

<http://aubethermostatmanual.com>

Golf course search by state

<http://golfingnear.com>

Email search by domain

<http://emailbydomain.com>

Auto manuals search

<http://auto.somanuals.com>

TV manuals search

<http://tv.somanuals.com>