

Cable/DSL Routers



Use this guide to install the following products:

- BEFSR41 ver. 2** EtherFast® Cable/DSL Router with 4-Port Switch
- BEFSRU31** EtherFast® Cable/DSL Router with USB Port and 3-Port Switch
- BEFSR11 ver. 2** EtherFast® 1-Port Cable/DSL Router

User Guide

LINKSYS®

COPYRIGHT & TRADEMARKS

Copyright © 2002 Linksys, All Rights Reserved. Linksys and EtherFast are registered trademarks of Linksys. Instant Broadband is a trademark of Linksys. Microsoft, Windows, and the Windows logo are registered trademarks of Microsoft Corporation. All other trademarks and brand names are the property of their respective proprietors.

LIMITED WARRANTY

Linksys guarantees that every Instant Broadband EtherFast Cable/DSL Router will be free from physical defects in material and workmanship for one year from the date of purchase, when used within the limits set forth in the Specifications section of this User Guide. If the product proves defective during this warranty period, call Linksys Technical Support in order to obtain a Return Authorization number. **BE SURE TO HAVE YOUR PROOF OF PURCHASE ON HAND WHEN CALLING.** When returning a product, mark the Return Authorization number clearly on the outside of the package and include a copy of your original proof of purchase. **RETURN REQUESTS CANNOT BE PROCESSED WITHOUT PROOF OF PURCHASE.** All customers located outside of the United States of America and Canada shall be held responsible for shipping and handling charges.

IN NO EVENT SHALL LINKSYS'S LIABILITY EXCEED THE PRICE PAID FOR THE PRODUCT FROM DIRECT, INDIRECT, SPECIAL, INCIDENTAL, OR CONSEQUENTIAL DAMAGES RESULTING FROM THE USE OF THE PRODUCT, ITS ACCOMPANYING SOFTWARE, OR ITS DOCUMENTATION. LINKSYS OFFERS NO REFUNDS FOR ITS PRODUCTS. Linksys makes no warranty or representation, expressed, implied, or statutory, with respect to its products or the contents or use of this documentation and all accompanying software, and specifically disclaims its quality, performance, merchantability, or fitness for any particular purpose. Linksys reserves the right to revise or update its products, software, or documentation without obligation to notify any individual or entity. Please direct all inquiries to:

Linksys P.O. Box 18558, Irvine, CA 92623.

FCC STATEMENT

The Instant Broadband EtherFast Cable/DSL Router has been tested and complies with the specifications for a Class B digital device, pursuant to Part 15 of the FCC Rules. These limits are designed to provide reasonable protection against harmful interference in a residential installation. This equipment generates, uses, and can radiate radio frequency energy and, if not installed and used according to the instructions, may cause harmful interference to radio communications. However, there is no guarantee that interference will not occur in a particular installation. If this equipment does cause harmful interference to radio or television reception, which is found by turning the equipment off and on, the user is encouraged to try to correct the interference by one or more of the following measures:

- Reorient or relocate the receiving antenna
- Increase the separation between the equipment or devices
- Connect the equipment to an outlet other than the receiver's
- Consult a dealer or an experienced radio/TV technician for assistance

UG-BEFSR11/41/U31-AOL-091402NC-KL

Table of Contents

Chapter 1: Introduction	1	Chapter 7: Configure the PCs	35
The Linksys EtherFast Cable/DSL Router	1	Overview	35
Features	1	Configuring Windows 95, 98, and Millennium PCs	36
Package Contents for the 4-Port Router (BEFSR41)	2	Configuring Windows 2000 PCs	38
Minimum Requirements	2	Configuring Windows XP PCs	40
Package Contents for the 1-Port Router (BEFSR11)	3	Chapter 8: Configure the Router	42
Minimum Requirements	3	Chapter 9: The Cable/DSL Router's	
Package Contents for the 3-Port Router with USB (BEFSRU31)	4	Web-based Utility	47
Minimum Requirements	4	Overview	47
An Introduction to LANs and WANs	4	Quick and Easy Router Administration	47
IP Addresses	5	Setup	48
Network Setup Overview	7	Password	54
Chapter 2: Getting to Know the 4-Port		Status	55
EtherFast Cable/DSL Router	8	DHCP	56
The 4-Port Router's Rear Panel	8	Log	58
The 4-Port Router's Front Panel LEDs	9	Security	59
Chapter 3: Getting to Know the 1-Port		Help	61
EtherFast Cable/DSL Router	11	Advanced	62
The 1-Port Router's Rear Panel	11	IP Filtering	63
The 1-Port Router's Front Panel LEDs	12	Port Range Forwarding	65
Chapter 4: Getting to Know the 3-Port		Dynamic Routing	70
EtherFast Cable/DSL Router	14	Static Routing	71
The 3-Port Router's Rear Panel	14	DMZ Host	73
USB Compatibility	15	MAC Address Clone	74
The 3-Port Router's Front Panel LEDs	16	Appendix A: Troubleshooting	75
Chapter 5: Connect the Router	18	Common Problems and Solutions	75
Overview	18	Frequently Asked Questions	88
Connecting Your Hardware Together and Booting Up	19	Appendix B: Glossary	92
Uplinking: Connecting More Devices to the Router	21	Appendix C: How to Ping Your ISP's E-mail &	
Chapter 6: Installing the BEFSRU31's USB		Web Addresses	105
Port Drivers	22	Appendix D: Installing the TCP/IP Protocol	108
Installing the Windows 98 Driver	22		
Installing the Windows 2000 Driver	27		
Installing the Windows Millennium Driver	31		
Installing the Windows XP Driver	33		

Chapter 1: Introduction

The Linksys EtherFast Cable/DSL Router

Congratulations on the purchase of the EtherFast Cable/DSL Router from Linksys! The Router is the perfect solution for connecting a network of PCs to a high-speed broadband Internet connection and to an Ethernet network backbone. Configurable as a DHCP server for your network, the Router is the only visible network device on the Internet. The Router also serves as your Internet NAT firewall, protecting your network's PCs from being accessed by external users. All incoming data packets are monitored and filtered. The Router can also be configured to block internal users' access to the Internet with IP filtering, as well as to play Internet games, videoconference, and much more. Plus, the Router supports Universal Plug and Play (UPnP), which allows Windows XP to automatically configure the Router for various Internet applications, such as videoconferencing and gaming—making the Router a snap to use.

Now all of your PCs can enjoy lightning-fast broadband Internet connections and share internal network data. Link them all together and network faster than you ever thought possible.

Features

- Connects Your Cable or DSL Modem to Multiple Computers for Internet, File, and Printer Sharing
- Set Up Your Computers and Router Easily Using Linksys Setup Wizard
- Supports UPnP for Easy Network Configuration
- Supports Enhanced Security Using NAT Firewall and ZoneAlarm Pro* and PC-cillin Software*
- Access Your Network Remotely over the Internet through Virtual Private Networking (VPN)—Supports IPSec and PPTP Pass-Through
- Easily Configurable through a Web Browser—Locally and over the Internet
- Administer and Upgrade the Router Remotely over the Internet
- Advanced Security Management Functions for Port Filtering, MAC Address Filtering, and DMZ Hosting
- 3- or 4-Port, 10/100 Mbps, Built-in Switch Speeds Up Your Gaming and Multimedia Experience (BEFSRU31 & BEFSR41 ver. 2 only)
- Configurable as a DHCP Server on Your Network

* each sold separately

Appendix E: Twisted-Pair Cabling	110
Crimping Your Own Network Cables	111
Appendix F: Finding the MAC Address and IP Address for Your Ethernet Adapter	112
Appendix G: Setting Up AOL® Broadband Cable & DSL	116
AOL Broadband via Cable	116
AOL Broadband via DSL	118
Appendix H: 4-Port Router Specifications	119
4-Port Environmental Specifications	119
Appendix I: 1-Port Router Specifications	120
1-Port Environmental Specifications	120
Appendix J: 3-Port Router Specifications	121
3-Port Environmental Specifications	121
Appendix K: Warranty Information	122
Appendix L: Contact Information	123

Package Contents for the 4-Port Router (BEFSR41)



Figure 1-1

- One EtherFast Cable/DSL Router with 4-Port Switch
- One Setup Wizard CD-ROM with User Guide Included
- One Power Adapter
- One Fast Start Guide
- One Registration Card (not shown)

Minimum Requirements

- One Windows PC equipped with:
 - TCP/IP Protocol,
 - Internet Explorer 4.0 or Netscape Navigator 4.7 for web-based configuration,
 - a CD-ROM Drive, and
 - an Ethernet Adapter with a UTP CAT 5 Network Cable
- Cable or DSL Modem with Ethernet Connection and Internet Access

Package Contents for the 1-Port Router (BEFSR11)



Figure 1-2

- One EtherFast 1-Port Cable/DSL Router
- One Setup Wizard CD-ROM with User Guide Included
- One Power Adapter
- One Fast Start Guide
- One Registration Card (not shown)

Minimum Requirements

- One Windows PC equipped with:
 - TCP/IP Protocol,
 - Internet Explorer 4.0 or Netscape Navigator 4.7 for web-based configuration,
 - a CD-ROM Drive, and
 - an Ethernet Adapter with a UTP CAT 5 Network Cable
- Cable or DSL Modem with Ethernet Connection and Internet Access

Package Contents for the 3-Port Router (BEFSRU31)



Figure 1-3

- One EtherFast Cable/DSL Router with USB Port & 3-Port Switch
- One Setup Wizard CD-ROM with User Guide Included
- One USB Cable
- One 3.5" Floppy Disk for USB Setup
- One Power Adapter
- One Fast Start Guide
- One Registration Card (not shown)

Minimum Requirements

- Internet Explorer 4.0 or Higher (5.5 Recommended), or Netscape Navigator 4.7 or Higher
- TCP/IP Protocol, Ethernet Adapter, and Ethernet Cable (UTP CAT 5 with RJ-45 connectors) per PC
- One External Cable or DSL Modem with Ethernet Port and Ethernet Cable (UTP CAT 5 with RJ-45 connectors)

An Introduction to LANs and WANs

Simply put, a **router** is a network device that connects two networks together.

In this instance, the Router connects your **Local Area Network (LAN)**, or the group of PCs in your home or office, to the **Wide Area Network (WAN)**, that is, the Internet. The Router processes and regulates the data that travels between these two networks.

Think of the Router as a network device with two sides: the first side is made up of your private **Local Area Network (LAN)** of PCs. The other, public side is the Internet, or the **Wide Area Network (WAN)**, outside of your home or office.

The Router's firewall (NAT) protects your network of PCs so users on the public, Internet side cannot "see" your PCs. This is how your LAN, or network, remains private. The Router protects your network by inspecting the first packet coming in through the WAN port before delivery to the final destination on the LAN port. The Router inspects Internet port services like the web server, ftp server, or other Internet applications, and, if allowed, it will forward the packet to the appropriate PC on the LAN side.

Remember that the Router's ports connect to two sides: your 10/100 LAN port(s) and the Internet WAN port. The LAN port(s) transmit data at 10 Mbps or 100 Mbps, whereas the broadband port, or WAN port, transmits data at 10 Mbps.

IP Addresses

What's an IP Address?

IP stands for Internet Protocol. Every device on an IP-based network, including PCs, print servers, and routers, requires an **IP address** to identify its "location," or address, on the network. This applies to both the WAN and LAN connections.

There are two ways of assigning an IP address to your network devices.

Static IP Addresses

A **static IP address** is a fixed IP address that you assign manually to a PC or other device on the network. Since a static IP address remains valid until you disable it, **static IP addressing** ensures that the device assigned it will always have that same IP address until you change it. Static IP addresses are commonly used with network devices such as server PCs or print servers.



Note: Since the Router is a device that connects two networks, it needs two IP addresses—one for the LAN side, and one for the WAN side. In this User Guide, you'll see references to the "WAN IP address" and the "LAN IP address."

Since the Router has firewall security (NAT), the only IP address that can be seen from the Internet for your network is the Router's WAN IP address.

However, even this WAN IP address for the Router can be blocked, so that the Router and network seem invisible to the Internet—see the Blocking WAN Requests description under IP Filtering in "Chapter 9: The Cable/DSL Router's Web-based Utility."

If you use the Router to share your cable or DSL Internet connection, contact your ISP to find out if they have assigned a static IP address to your account. If so, you will need that static IP address when configuring the Router. You can get the information from your ISP.

Dynamic IP Addresses

A **dynamic IP address** is automatically assigned to a device on the network, such as PCs and print servers. These IP addresses are called “dynamic” because they are only *temporarily* assigned to the PC or device. After a certain time period, they expire and may change. If a PC logs onto the network (or the Internet) and its dynamic IP address has expired, the **DHCP server** will assign it a new dynamic IP address.

For DSL users, many ISPs may require you to log on with a user name and password to gain access to the Internet. This is a dedicated, high-speed connection type called Point to Point Protocol over Ethernet (PPPoE). PPPoE is similar to a dial-up connection, but PPPoE does not dial a phone number when establishing a connection. PPPoE also will provide the Router with a dynamic IP address to establish a connection to the Internet.

DHCP (Dynamic Host Configuration Protocol) Servers

PCs and other network devices using dynamic IP addressing are assigned a new IP address by a **DHCP server**. The PC or network device obtaining an IP address is called the DHCP client. DHCP frees you from having to assign IP addresses manually every time a new user is added to your network.

A DHCP server can either be a designated PC on the network or another network device, such as the Router. By default, the Router’s WAN setting is DHCP client.

By default, a DHCP server (LAN side) is enabled on the Router. If you already have a DHCP server running on your network, you *must* disable one of the two DHCP servers. If you run more than one DHCP server on your network, you will experience network errors, such as conflicting IP addresses. To disable DHCP on the Router, see the DHCP section in “Chapter 9: The Cable/DSL Router’s Web-based Utility.”



Note: Even if you assign a static IP address to a PC, other PCs can still use DHCP’s dynamic IP addressing, as long as the static IP address is not within the DHCP range of the LAN IP Address.

If the dynamic IP addressing fails to provide a dynamic IP address, refer to “Appendix A: Troubleshooting.”

Network Setup Overview

This user guide covers the basic steps for setting up a network with a router. After going through the appropriate “Getting to Know the Router” chapter (Chapter 2, 3, or 4, depending on which Router you have), most users will only need to use the following chapters:

- Chapter 5: Connect the Router
This chapter instructs you on how to connect the cable or DSL modem to the Router and connect the PC(s) to the Router.
- Chapter 7: Configure the PCs
This chapter instructs you on how to configure your PC(s) for a DHCP connection, if the network settings are not already set to DHCP.
- Chapter 8: Configure the Router
This chapter explains how to configure the Router using your web browser and the Router’s web-based utility. You will configure the Router using the settings provided by your ISP.

When you’re finished with the basic steps, then you are ready to connect to the Internet. After the PC(s) can access the Internet through the Router, you can alter the Router’s settings further; for example, you can adjust security features and other settings to enable online gaming.



Note: To learn about additional security features, ZoneAlarm Pro and PC-cillin (each sold separately), see “Chapter 9: The Cable/DSL Router’s Web-based Utility.”



Figure 1-4

Chapter 2: Getting to Know the 4-Port EtherFast® Cable/DSL Router

The 4-Port Router's Rear Panel

The Router's ports, where network cables are connected, are located on the rear panel of the Router, as shown in Figure 2-1.



Figure 2-1

WAN	The WAN (Wide Area Network) port is where you connect your cable or DSL modem through an Ethernet cable. Your modem connection will not work from any other port.
Ports 1-4	These four LAN (Local Area Network) ports connect to network devices, such as PCs, print servers, and remote hard drives. If Port 1 is being used, the Uplink port will not work because these two shared ports have internally shared wiring.
Uplink	The Uplink port is used to expand your network by connecting to another switch or hub. To uplink to a switch or a hub, simply run a cable from the Uplink port to the other device. See the “Uplinking: Connecting More Devices to the Router” section for more on uplinking. If the Uplink port is being used, Port 1 will not work.
Power	The Power port is where you will connect the power adapter.

The 4-Port Router's Front Panel LEDs



Figure 2-2

Power	<i>Green.</i> The Power LED lights up when the Router is powered on.
Link/Act	<i>Green.</i> The Link/Act LED serves two purposes. If the LED is continuously lit, the Router is successfully connected to a device through the corresponding port (1 , 2 , 3 or 4). If the LED is flickering, the Router is actively sending or receiving data over that port. Port 1 is lit when using the Uplink port.
Full/Col	<i>Green.</i> The Full/Col LED also serves two purposes. If this LED is lit up continuously, the connection made through the corresponding port is running in Full Duplex mode. If the LED flickers, the connection is experiencing collisions. Infrequent collisions are normal. If this LED flickers too often, there may be a problem with your connection. See “Appendix A: Troubleshooting” if you encounter this problem.
100	<i>Orange.</i> The 100 LED lights up when a successful 100Mbps connection is made through the corresponding port. If this LED does not light up, then your connection speed is 10 Mbps.

The WAN Indicators

- Link** *Green.* The **Link** LED lights up when a successful connection is made between the Router and your cable or DSL modem or network.
- Act** *Green.* The **Act** LED flickers when the Router is sending or receiving data over the **WAN** port (to the Internet).
- Diag** *Red.* The **Diag** LED lights up when the Router goes through its self-diagnosis mode during every boot-up. It will turn off upon successful completion of the diagnosis.

If this LED stays on for an abnormally long period of time, see “Appendix A: Troubleshooting.”

The Reset Button*

The **Reset** button can be used in one of two ways.

1. If the Router is having problems connecting to the Internet, press the **Reset** button for just a moment with a paper clip or a pencil tip. This clears up any jammed connections, and is similar to pressing the **Reset** button on your PC to reboot it.
2. If you are experiencing extreme problems with the Router and have tried all other troubleshooting measures, press the **Reset** Button and hold it down until the red **Diag** LED on the front panel turns on and off completely.

This will restore factory defaults and clear all of the Router’s settings, including settings such as IP addresses or a new password.

* The **Reset** Button is located on the front panel of the 4-Port Router, and the rear panels of the 3-Port Router and the 1-Port Router.

Proceed to “Chapter 5: Connect the Router.”

Chapter 3: Getting to Know the 1-Port EtherFast Cable/DSL Router

The 1-Port Router’s Rear Panel

The rear panel of the Router is where all of the Router’s cabling connections are made, and where you can reset or configure the Router’s LAN port, as shown in Figure 3-1.



Figure 3-1

WAN

The **WAN** (Wide Area Network) port is where you connect your cable or DSL modem through an Ethernet cable. **Your modem connection will not work from any other port.**

LAN

The **LAN** (Local Area Network) port is where you connect the Router to a PC, hub, or switch. If you have more than one PC, connect an Ethernet hub or switch to the Router, and then connect your PCs to that hub or switch.

Power

The **Power** port is where you will connect the power adapter.

Buttons & Switches

The Reset Button

Details on the **Reset** button are found in the “Chapter 2: Getting to Know the 4-Port EtherFast Cable/DSL Router.”

The Crossover Switch

When “uplinking,” or connecting two pieces of network hardware together, such as a hub and a switch, a **general rule of thumb** is to plug one end of a network cable into a straight-through port, and the other end into a crossover port (uplink port). Standard ports are straight-through ports, and uplink ports are crossover ports.

Switch Position	Straight Through Cable	Crossover Cable
X	LAN Port on Router to Regular Port on Switch or Hub	LAN Port on Router to Uplink Port on Switch or Hub
 	LAN Port on Router to Uplink Port on Switch or Hub	LAN Port on Router to Regular Port on Switch or Hub

Figure 3-2



Important: The chart in Figure 3-2 is for reference purposes only. Every network is different. If you do not make a connection to a hub or switch by using the settings above, change the position of the Crossover Switch.

The 1-Port Router's Front Panel LEDs



Figure 3-3

Power *Green.* The **Power** LED lights up green when the Router is powered on.

Link/Act *Green.* The **Link/Act** LED serves two purposes. If the LED is continuously lit, the Router is successfully connected to a device through the **LAN** port. If the LED is flickering, the Router is actively sending or receiving data through the **LAN** port.

Full/Col *Green.* The **Full/Col** LED also serves two purposes. If this LED remains lit, a LAN port connection is being successfully maintained. If the LED flickers, the connection is experiencing collisions. Infrequent collisions are normal.

If this LED flickers too often, there may be a problem with your connection. See “Appendix A: Troubleshooting” if you encounter this problem.

10/100 *Orange.* The **10/100** LED lights up when a successful 100 Mbps connection is made through the corresponding port.

If a connection is running at 10 Mbps, the **10/100** LED will not light up.

The WAN Indicators

Link *Green.* The **Link** LED lights up when a successful connection is made between the Router and your broadband device or network.

Act *Green.* The **Act** LED flickers when the Router is sending or receiving data over the **WAN** port.

Diag *Red.* The **Diag** LED lights up when the Router goes through its self-diagnostic mode. It will turn off upon successful completion of the diagnosis.

If this LED stays on for an abnormally long period of time, see “Appendix A: Troubleshooting.”

Proceed to “Chapter 5: Connect the Router.”

Chapter 4: Getting to Know the 3-Port EtherFast Cable/DSL Router

The 3-Port Router's Rear Panel



Figure 4-1

- Ports 1-3** These three **LAN** ports connect to your PCs, hubs, switches, print servers, or any other devices with an Ethernet port.
- Uplink** The **Uplink** port connects to another hub or switch for port expansion when you run out of open ports for your network devices. Since the **Uplink** port and the standard port right next to it share internal wiring, you can only use one of the two ports at a time.
- WAN** The **WAN** (Wide Area Network) port is where you connect your cable or DSL modem through an Ethernet cable. **Your modem connection will not work from any other port.**
- Power** The **Power** port is where you will connect the power adapter.
- USB** The USB port (Type B - slave) can connect to a USB-ready PC or a USB hub. This allows you to enjoy an immediate, plug-and-play connection without even installing an Ethernet adapter for your PC. To work with USB ports, your PC must be running Windows 98, 2000, Millennium, or XP.
- The Reset Button** Details on the **Reset** button are found in the "Chapter 2: Getting to Know the 4-Port EtherFast Cable/DSL Router."

USB Compatibility



Note: USB ports do not work on PCs running Windows 95 or NT.

To use the USB port on the 3-Port Router, you must have Windows 98, 2000, Millennium, or XP installed on your PC. USB cannot run in a Windows 95 or NT environment.

Also, your PC must have a USB port installed and enabled. Some PCs may have a disabled USB port. If your port doesn't seem to be working, there may be jumpers on the motherboard or a menu option in the BIOS to enable a PC's USB port.

Other motherboards have USB interfaces, but no ports. You can purchase and install a USB-ready card at your local computer store. See your PC's user guide for instructions.

This USB icon, shown in Figure 4-2, denotes the presence of a USB port or connector.



Figure 4-2

The 3-Port Router comes with a USB cable that has two different types of connectors. Type A, the master connector, is shaped like a rectangle and plugs into your PC's USB port. Type B, the slave connector, resembles a square and connects to the USB port on the rear panel of the Router.

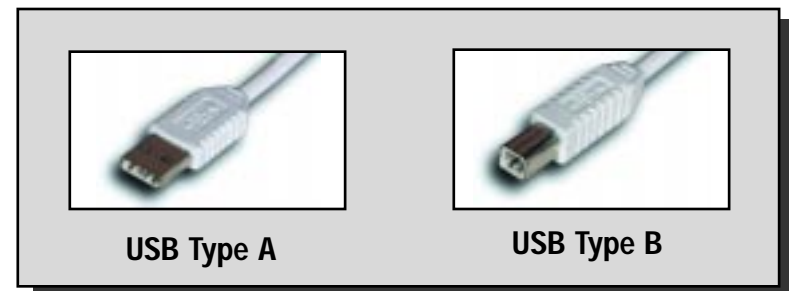

Figure 4-3

The 3-Port Router's Front Panel LEDs



Figure 4-4

- Power** *Green.* The **Power** LED lights up green when the Router is powered on.
- Link/Act** *Green.* The **Link/Act** LED serves two purposes. If the LED is continuously lit, the Router is successfully connected to a device through the corresponding RJ-45 port (**1**, **2**, or **3**). If the LED flickers, then that port is sending or receiving data to and from the network. When the Uplink port is in use, then Port 3 will be lit.
- Full/Col** *Green.* The **Full/Col** LED also serves two purposes. If this LED is continuously lit, the connection made through the corresponding port is running in Full Duplex mode. If the LED is flickering, the connection is experiencing collisions. Infrequent collisions are normal.
- If this LED flickers too often, there may be a problem with your connection. See “Appendix A: Troubleshooting” if you have problems.
- 100** *Orange.* The **100** LED lights up when a successful 100 Mbps connection is made through the corresponding port. If this LED does not light up, then your connection speed is 10 Mbps.
- USB** The **USB** LED lights up when the USB port is successfully connected to a USB-ready PC or USB hub.

The WAN Indicators

- Link** *Green.* The **Link** LED lights up when a successful connection is made between the Router and your broadband device or network.
- Act** *Green.* The **Act** LED flickers when the Router is sending or receiving data over the broadband **WAN** port.
- Diag** *Red.* The **Diag** LED lights up when the Router goes through its self-diagnostic mode. It will turn off upon successful completion of the diagnosis.

If this LED stays on for an abnormally long period of time, see “Appendix A: Troubleshooting.”

Proceed to “Chapter 5: Connect the Router.”

Chapter 5: Connect the Router

Overview

Unlike a hub or a switch, the Cable/DSL Router's setup consists of more than simply plugging hardware together. You will have to configure your networked PCs to accept the IP addresses that the Router assigns them (if applicable), and you will also have to configure the Router with setting(s) provided by your Internet Service Provider (ISP).

The installation technician from your ISP should have left the setup information with you after installing your broadband connection. If not, you can call your ISP to request the data.

Once you have the setup information you need for your specific type of Internet connection, you can begin installation and setup of the Router.



Figure 5-1

Connecting Your Hardware Together and Booting Up

1. Before you begin, make sure that all of your hardware is powered off, including the Router, PCs, hubs, switches, and cable or DSL modem.
2. If you have the 4-Port Router, go to step 2.A. If you have the 1-Port Router, go to step 2.B. If you have the 3-Port Router, go to step 2.C.

2. **A. If you have the 4-Port Cable/DSL Router**, connect one end of an Ethernet cable to one of the LAN ports (labeled **1**, **2**, **3**, or **4**) on the back of the Router, and the other end to a standard port on a network device, e.g., a PC, print server, hub, or switch. See “Appendix E: Twisted-Pair Cabling” for details on network cabling.



Note: A **standard port** is any port other than the WAN port and the Uplink port on the Router. It is a straight-through port.

Repeat the above step to connect more PCs or network devices to the Router.

2. **B. If you have the 1-Port Router**, connect one end of an Ethernet cable to the LAN port on the back of the Router, and the other end to a port on a network device, e.g., a PC, hub, or switch. If you are using the LAN Port to connect to a PC, set the Crossover switch to straight-through mode (**||**). If you are connecting the Router to a hub or switch, refer to the chart shown in Figure 5-2 when setting the Crossover switch.

Switch Position	Straight Through Cable	Crossover Cable
X	LAN Port on Router to Regular Port on Switch or Hub	LAN Port on Router to Uplink Port on Switch or Hub
 	LAN Port on Router to Uplink Port on Switch or Hub	LAN Port on Router to Regular Port on Switch or Hub

Figure 5-2

2. **C. If you have the 3-Port Cable/DSL Router**, connect one end of an Ethernet cable from the Router's LAN ports (labeled **1**, **2**, or **3**) to an Ethernet adapter port on a PC, hub, switch, or other network device.

The 3-Port Router features one USB plug-and-play port that connects instantly to any USB-ready PC or USB hub. This allows you to connect to and access the Router without even installing any Ethernet adapter cards.

3. Connect the Ethernet cable from your cable or DSL modem to the **WAN** port on the Router's rear panel. This is the only port that will work for your modem connection.
4. Connect the power adapter to the Power port on the rear panel of the Router, and then plug the power adapter into a power outlet.



Note: You should always plug the Router's power adapter into a surge protecting power strip.

- The **Power** LED on the front panel will light up green as soon as the power adapter is connected properly.
 - The **Diag** LED will light up red for a few seconds when the Router goes through its self-diagnostic test. This LED will turn off when the self-test is complete.
5. Power on the cable or DSL modem.
 6. Press the **Reset** button on the Router's front panel with a paper clip or a pencil. Hold the button in until the **Diag** LED lights up and then turns off. This will restore the Router's factory default settings.



Have you checked that the **Link/Act LEDs for all your LAN connections and the **Link** LED for your WAN connection light up?**

If all of your **Link** LEDs are not lighting up, make sure that all your cables are securely plugged in, and that all of your hardware is powered on properly. Verify that the modem is plugged into the WAN port on the Router.

The Router's hardware installation is now complete.

Uplinking: Connecting More Devices to the Router

If the Router's **LAN** ports are all full and you still have PCs and/or devices to connect, connect a hub or a switch to the Router using an Ethernet cable.

To do so, use the Router's **Uplink** port to connect to a standard port on a hub or switch. This leaves you with new, open ports on the hub or switch, to which you can add more PCs and/or network devices.

If you have a PC/device connected to the port right next to the **Uplink** port (on the 3- and 4-Port Routers), disconnect that PC/device and plug it into an open port on the new hub or switch.

Since the **Uplink** port shares internal wiring with the port right next to it, you can only use one of these two ports at a time; these ports are called **shared ports**.

If your new hub or switch also has an **Uplink** port, it too can be uplinked when you run out of ports, and so on.

See your nearest Linksys retailer or visit www.linksys.com for complete product lines of 10/100 Mbps hubs and switches.

If you have a 3-Port Router with USB and you are using its USB port, then proceed to the next page, "Chapter 6: Installing the BEFSRU31's USB Port Drivers." Otherwise, go to "Chapter 7: Configure the PCs."

Chapter 6: Installing the BEFSRU31's USB Port Drivers

Use the enclosed USB cable to connect your PC to the Router; the Type A end connects to your PC's USB port, while the Type B end connects to the Router's USB port. Now that all of the Router's hardware is connected together, you must enable the PC that will connect to the Router through its USB port.

Since your USB connection acts as an Ethernet adapter for your PC, there's no need for you to install an Ethernet adapter on that PC. Just follow the directions below to enable your PC's USB connection to the Router:

- If you are running Windows 98, continue to the section below on this page.
- For other Windows operating systems, please refer to the appropriate section in this chapter as listed in the Table of Contents.



Note: After you finish this configuration, make sure that TCP/IP is installed on your PC(s). For instructions on installing TCP/IP, see "Appendix D: Installing the TCP/IP Protocol."

You can also connect the Router's USB port to other USB devices besides USB-ready PCs, such as a USB hub using a USB cable.

Installing the Windows 98 Driver

1. With the Router powered up and connected to your PC's USB port using a USB cable, start up your PC in Windows 98, and have the Router's driver disk available.
2. Windows will notify you that it has detected new hardware, as shown in Figure 6-1. Click the **Next** button.



Figure 6-1

3. Select **Search for the best driver for your device (Recommended)**, shown in Figure 6-2. Click the **Next** button.



Figure 6-2

4. Insert the driver disk into the floppy drive, and select **Floppy disk drives** only, as shown in Figure 6-3. Click the **Next** button to start the search for your driver.

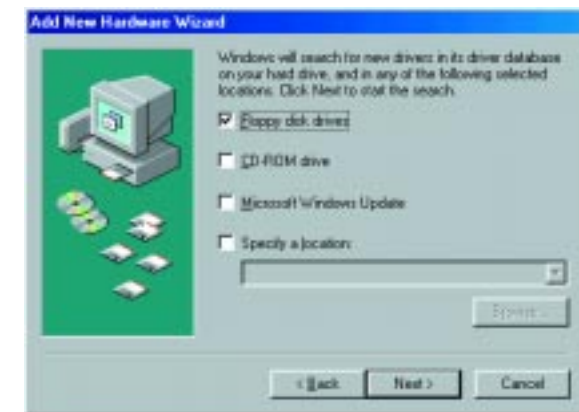

Figure 6-3

5. The Hardware Wizard will search the floppy, and a new window will appear (shown in Figure 6-4), notifying you that Windows is now ready to install the best driver for this device. Click the **Next** button to continue.



Figure 6-4

6. Windows will begin copying the files to your PC, as shown in Figure 6-5. Do not click the **Cancel** button or press the **Esc** key during this process.

If Windows asks for your Windows operating system files before copying, direct your PC to the location of those files, e.g. **c:\windows\options\cabs**, or **D:\Win98** (if "D" is the letter of your CD-ROM drive).

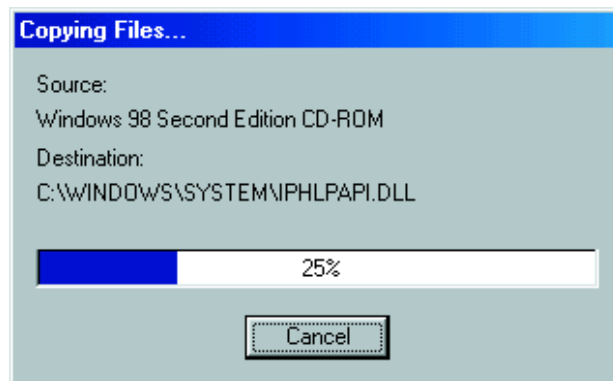

Figure 6-5

7. Windows will notify you that it has completed copying the driver files to your PC, as shown in Figure 6-6. Click the **Finish** button to complete the USB driver installation.

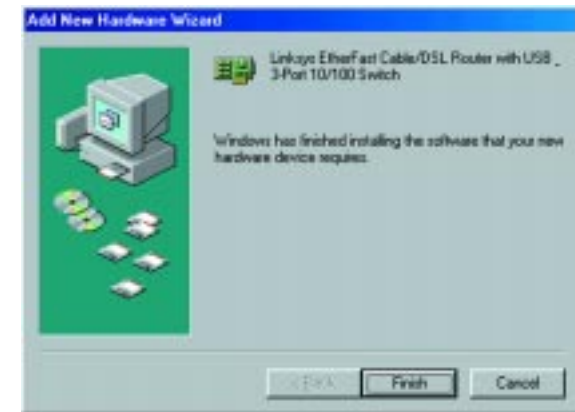

Figure 6-6

8. Windows will ask you if you want to restart your PC, as shown in Figure 6-7. Click the **Yes** button so your new installation will take effect.

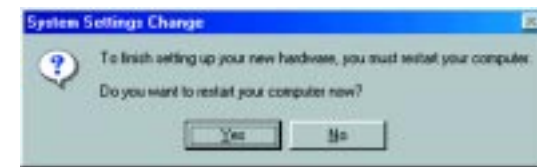

Figure 6-7

If it does not ask you to restart your computer, click the **Start** button, and select **Shut Down**. Then select **Restart** and click the **OK** button.

9. When your PC has finished restarting, click the **Start** button, and select **Settings** and **Control Panel**. Double-click **Network**. Make sure that TCP/IP is installed on your PC, as shown on the screen in Figure 6-8. By default, Windows 98 has TCP/IP installed. If TCP/IP is not installed, please go to “Appendix D: Installing the TCP/IP Protocol” for installation instructions.



Figure 6-8

**Your USB driver installation is now complete.
Go to “Chapter 7: Configure the PCs.”**

Installing the Windows 2000 Driver

1. With the Router powered up and connected to your PC’s USB port using a USB cable, start up your PC in Windows 2000, and have the Router’s driver disk available. Windows will notify you that the PC has found new hardware. The Windows’ Hardware Wizard will then notify you that it is ready to start installing the driver files on your PC, as shown in Figure 6-9. Click the **Next** button.



Figure 6-9

2. Select **Search for a suitable driver for my device (Recommended)**, as shown in Figure 6-10, and click the **Next** button.

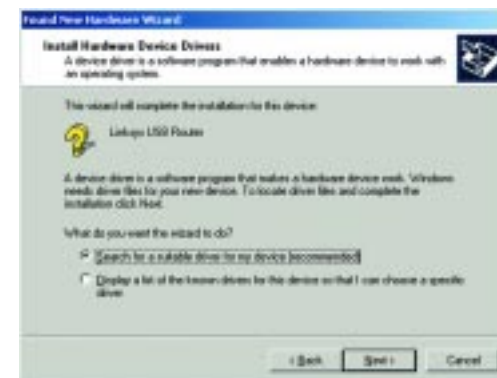

Figure 6-10

3. Insert the driver disk into the floppy drive, and when Windows asks you where to search for driver files, select **Floppy disk drives** only, as shown in Figure 6-11. Click the **Next** button.



Figure 6-11

4. Windows will notify you that it has found the driver files. (See Figure 6-12.) Click the **Next** button.



Figure 6-12

5. When the Digital Signature Not Found screen appears, as shown in Figure 6-13, Windows will ask you if you want to continue the installation. Click the **Yes** button.



Figure 6-13

6. Click the **Next** button from the screen shown in Figure 6-14 to allow Windows to copy the driver files to your PC.



Figure 6-14

7. Windows will notify you that it has finished installing the driver files on your PC, as shown in Figure 6-15. Click the **Finish** button to complete the USB driver installation.



Figure 6-15

8. Go to the **Start** button, and select the **Settings** option. Then select the **Network and Dial-up Connections** option, and click the **Local Area Connection** icon. Click the **Properties** button to display the screen shown in Figure 6-16. Highlight **Internet Protocol (TCP/IP)**, as shown in Figure 6-16, and click the **Properties** button. Make sure that TCP/IP is set to **Obtain an IP address automatically**.

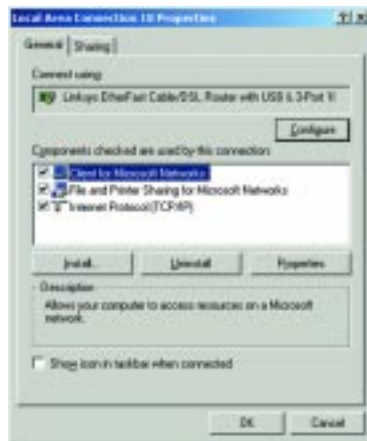

Figure 6-16

**Your USB driver installation is now complete.
Go to “Chapter 7: Configure the PCs.”**

Installing the Windows Millennium Driver

1. With the Router powered up and connected to your PC's USB port using a USB cable, start up your PC in Windows Millennium.



Figure 6-17

2. Windows will notify you that new hardware has been detected (see Figure 6-17). Insert the driver disk. Select **Automatic search for a better drive (Recommended)**, and click the **Next** button (see Figure 6-18).



Figure 6-18

3. Windows will notify you that it has finished installing the driver files on your PC, as shown in Figure 6-19. Click the **Finish** button.



Figure 6-19

4. Windows will ask you to restart your PC, as shown in Figure 6-20. Click the **Yes** button.

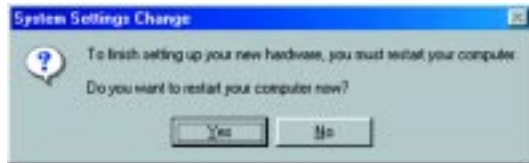

Figure 6-20

5. When your PC has finished restarting, click the **Start** button, and select **Settings** and **Control Panel**. Double-click **Network** and you will see a screen similar to that shown in Figure 6-21. Make sure that TCP/IP is installed for your PC, as shown in Figure 6-21. By default, Windows Millennium has TCP/IP installed. If TCP/IP is not installed, please go to “Appendix D: Installing the TCP/IP Protocol” for instructions on installation.

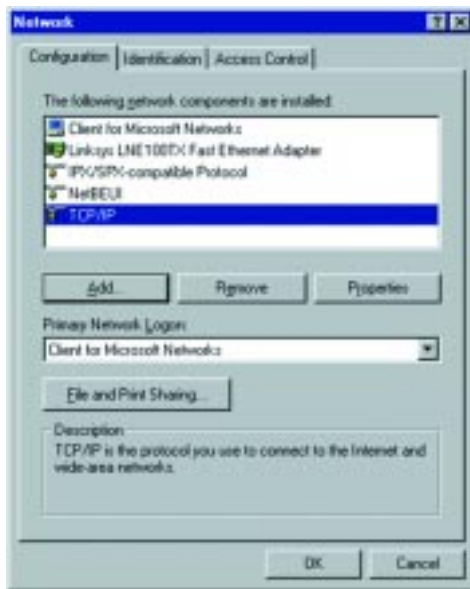

Figure 6-21

**Your USB driver installation is now complete.
Go to “Chapter 7: Configure the PCs.”**

Installing the Windows XP Driver

1. With the Router connected to your PC's USB port using a USB cable, start up your PC in Windows XP.

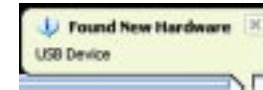

Figure 6-22

2. Windows will notify you that new hardware has been detected (shown in Figure 6-22). Select **Install from a list or specific location (Advanced)**, and click the **Next** button (see Figure 6-23).



Figure 6-23

3. Insert the driver disk into the floppy drive, and select **Search for the best driver in these locations**. Then select **Include this location in the search**: and enter **A:** in the location field (if “A” is the letter of your floppy drive). (See Figure 6-24.) All other options must be unchecked (assuming you are running Windows XP with the default interface). Click the **Next** button.



Figure 6-24

4. When the Hardware Installation screen appears shown in Figure 6-25, click **Continue Anyway**.



Figure 6-25

5. Windows will notify you that it has finished installing the driver files on your PC, as shown in Figure 6-26. Click the **Finish** button to complete the USB driver installation.



Figure 6-26

6. Click the **Start** button and then **Control Panel**. Click **Network and Internet Connections** and then **Network Connections**. Double-click **Local Area Connection**. Click **Properties**. Check for **Internet Protocol (TCP/IP)** to make sure that TCP/IP is installed on your PC. By default, Windows XP has TCP/IP installed. If TCP/IP is not installed, please refer to your Windows XP user guide to install TCP/IP.

**Your USB driver installation is now complete.
Go to “Chapter 7: Configure the PCs.”**

Chapter 7: Configure the PCs

Overview

The instructions in this chapter will help you configure each of your computers to be able to communicate with the Router.

To do this, you need to configure your PC's network settings to obtain an IP (or TCP/IP) address automatically (called DHCP). Computers use IP addresses to communicate with each other across a network or the Internet.

Find out which operating system your computer is running, such as Windows 95, 98, Millennium, NT 4.0, 2000, or XP. You will need to know which operating system your computer is running. You can find out by clicking the **Start** button and then going to the **Settings** option. Then click **Control Panel**, and then double-click the **System** icon. If your Start menu doesn't have a Settings option, you're running Windows XP. Click the **Cancel** button when done.

You may need to do this for each computer you are connecting to the Router.



Important: These instructions apply only to Windows 95, Windows 98, Windows Millennium, Windows 2000, or Windows XP machines. For TCP/IP setup under Windows NT, see your Windows manual. By default Windows 98, 2000, Me, and XP has TCP/IP installed and set to obtain an IP address automatically.

The next few pages tell you, step by step, how to configure your network settings based on the type of Windows operating system you are using. Make sure that an Ethernet card or adapter has been successfully installed in each PC you will configure (the only exception is the PC you connect to the 3-Port Router using the USB port and cable). Once you've configured your computers, continue to “Chapter 8: Configure the Router.”

Configuring Windows 95, 98, and Millennium PCs

1. Go to the Network screen by clicking the **Start** button. Click **Settings** and then **Control Panel**. From there, double-click the **Network** icon.
2. On the Configuration tab, select the **TCP/IP line** for the applicable Ethernet adapter, as shown in Figure 7-1. Do not choose a TCP/IP entry whose name mentions DUN, PPPoE, VPN, or AOL. If the word **TCP/IP** appears by itself, select that line. (If there is no TCP/IP line listed, refer to “Appendix D: Installing the TCP/IP Protocol” or your Ethernet adapter’s user guide to install TCP/IP now.) Click the **Properties** button.



Figure 7-1

3. Click the **IP Address** tab and select **Obtain an IP address automatically**, as shown in Figure 7-2.



Figure 7-2

4. Now click the **Gateway** tab to ensure that the Installed Gateway field is left blank. Click the **OK** button.
5. Click the **OK** button again. Windows may ask you for the original Windows installation disk or additional files. Supply them by pointing to the correct file location, e.g., D:\win98, D:\win9x, c:\windows\options\cabs, etc. (if “D” is the letter of your CD-ROM drive).
6. Windows may ask you to restart your PC. Click the **Yes** button. If Windows does not ask you to restart, restart your computer anyway.

Go to “Chapter 8: Configure the Router.”

Configuring Windows 2000 PCs

1. Go to the Network screen by clicking the **Start** button. Click **Settings** and then **Control Panel**. From there, double-click the **Network and Dial-up Connections** icon.
2. Select the **Local Area Connection** icon for the applicable Ethernet adapter (usually it is the first Local Area Connection listed). Do not choose a TCP/IP entry whose name mentions DUN, PPPoE, VPN, or AOL. Double-click the **Local Area Connection**.



Figure 7-3

3. The Local Area Connection Status screen will appear, as shown in Figure 7-3. Click the **Properties** button.



Figure 7-4

5. Select **Obtain an IP address automatically**, as shown in Figure 7-5. Once the new window appears, click the **OK** button. Click the **OK** button again to complete the PC configuration.



Figure 7-5

6. Restart your computer.

Go to “Chapter 8: Configure the Router.”

Configuring Windows XP PCs

The following instructions assume you are running Windows XP with the default interface. If you are using the Classic interface (where the icons and menus look like previous Windows versions), please follow the instructions for Windows 2000.

1. Click to the Network screen by clicking the **Start** button and then **Control Panel**. From there, click the **Network and Internet Connections** icon and then the **Network Connections** icon.
2. Select the **Local Area Connection** icon for the applicable Ethernet adapter (usually it is the first Local Area Connection listed). Double-click the **Local Area Connection**.



Figure 7-6

3. The Local Area Connection Status screen will appear, as shown in Figure 7-6. Click the **Properties** button.



Figure 7-7

5. Select **Obtain an IP address automatically**, as shown in Figure 7-8. Once the new window appears, click the **OK** button. Click the **OK** button again (or the **Close** button if any settings were changed) to complete the PC configuration.



Figure 7-8

6. Restart your computer.

Go to “Chapter 8: Configure the Router.”

Chapter 8: Configure the Router

This chapter will show you how to configure the Router to function in your network and gain access to the Internet through your Internet Service Provider (ISP). Detailed description of the Router's Web-based Utility can be found in "Chapter 9: The Cable/DSL Router's Web-based Utility." Your ISP may require the use of a Host Name and Domain Name. Further, you will set the WAN Connection Type on the Router's Setup tab based on the information provided by your ISP. *You will need the setup information from your ISP.* If you do not have this information, please contact your ISP before proceeding.

The instructions from your ISP tell you how to set up your PC for Internet access. Because you are now using the Router to share Internet access among several computers, you will use the setup information to configure the Router instead of your PC. You only need to configure the Router once using the first computer you set up.

1. Open your web browser. (It is all right if you get an error message at this point. Continue following these directions.) Enter **http://192.168.1.1** in the web browser's Address field, as shown in Figure 8-1, and press the **Enter** key.

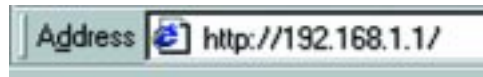

Figure 8-1

2. An Enter Network Password window, shown in Figure 8-2, will appear (Windows XP users will see a Connect to 192.168.1.1 window, shown in Figure 8-3). Leave the User Name field empty, and enter **admin** in lowercase letters in the Password field (**admin** is the default password). Then, click the **OK** button.

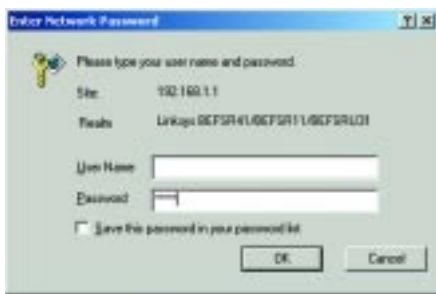

Figure 8-2



Figure 8-3

3. The Router configuration screen will appear with the Setup tab selected. Based on the setup instructions from your ISP, you may need to provide the following information.

Host Name and Domain Name: These fields allow you to provide a host name and domain name for the Router. These fields are usually left blank. If requested by your ISP (usually cable ISPs), complete these two fields.

Device IP Address and Subnet Mask: The values for the Router's IP Address and Subnet Mask are shown on the Setup screen. The default value is 192.168.1.1 for the IP Address and 255.255.255.0 for the Subnet Mask. Leave these settings alone.

4. The Router supports five connection types: DHCP (obtain an IP automatically), PPPoE, Static IP Address, RAS, and PPTP. These types are listed in the drop-down menu for the **WAN Connection Type** setting. Each Setup screen and available features will differ depending on what kind of connection type you select. Proceed to the instructions for the connection type you are using. When you are finished with the Setup tab, proceed to step 5.



IMPORTANT: If you have previously enabled any **Internet-sharing proxy server software** on any of your PCs, you must disable it now.

Some examples of Internet-sharing software are Internet LanBridge, Wingate, ICS, and Sygate. To disable your Internet-sharing software:

- If you are running Netscape Navigator, click **Edit >> Preferences >> Advanced >> Proxies**. Click **Direct Connection to the Internet**.
- If you are running Internet Explorer 5.x or higher, click **Start >> Settings >> Control Panel >> Internet Options >> Connections >> LAN Settings**. Remove checkmarks from all three boxes. Click the **OK** button to continue.

Also, you must disable any **Internet log-on software** (such as Ivasion Winpoet or Enternet 300) and any **firewall software** (such as ZoneAlarm and Watchdog) on all of your PCs.

DHCP or Obtain an IP Address Automatically

If your ISP says that you are connecting through DHCP or a dynamic IP address from your ISP, perform these steps:

- Select **Obtain an IP automatically** as the WAN Connection Type, as shown in Figure 8-4.



Figure 8-4

- Click the **Apply** button to save the setting., or click the **Cancel** button to clear the setting and start over. When you are finished, then proceed to step 5.

Static IP Address or Specify an IP Address

If your ISP says that you are connecting through a static or fixed IP address from your ISP, perform these steps:

- Select **Static IP** as the WAN Connection Type, as shown in Figure 8-5.



Figure 8-5

- Enter the **IP Address**.
- Enter the **Subnet Mask**.
- Enter the **Gateway Address**.
- Enter the **DNS** in the 1, 2, and/or 3 fields. You need to enter at least one DNS address.
- Click the **Apply** button to save the settings, or click the **Cancel** button to clear the settings and start over. When you are finished, then proceed to step 5.

PPPoE

If your DSL provider says that you are connecting through PPPoE or if you normally enter a user name and password to access the Internet, perform these steps:

- Select **PPPoE** as the WAN Connection Type, as shown in Figure 8-6.



Figure 8-6

- Enter the **User Name**.

- Enter the **Password**.

- Click the **Apply** button to save the settings., or click the **Cancel** button to clear the settings and start over.

- When you are finished, click the **Status** tab, and then click the **Connect** button to start the connection. Proceed to step 5.

RAS

RAS (shown in Figure 8-7) is a service used in Singapore only. If you are using a RAS connection, check with your ISP for the necessary setup information.

When you are finished with the Setup tab, proceed to step 5.



Figure 8-7

PPTP

PPTP (shown in Figure 8-8) is a service used in Europe only. If you are using a PPTP connection, check with your ISP for the necessary setup information.

When you are finished with the Setup tab, proceed to step 5.



Figure 8-8

5. If you haven't already done so, click the **Apply** button to save your Setup settings. Close the web browser.
6. Reset the power on your cable or DSL modem.
7. Restart your computers so that they can obtain the Router's new settings.

If you need advanced setting information, please refer to "Chapter 9: The Cable/DSL Router's Web-based Utility" or the Linksys support website at support.linksys.com.

Congratulations! You've successfully configured the Router. Test the setup by opening your web browser from any computer and entering www.linksys.com/registration, as shown in Figure 8-9.

If you are unable to reach our website, you may want to review what you did in this section or refer to "Appendix A: Troubleshooting."



Figure 8-9

Proceed to "Chapter 9: The Cable/DSL Router's Web-based Utility" for more details and advanced settings information.

Chapter 9: The Cable/DSL Router's Web-based Utility

Overview

For your convenience, use the Router's web-based utility to administer it. This chapter will explain all of the functions in this utility. The utility can be accessed via Microsoft Internet Explorer or Netscape Navigator through use of a computer connected with an Ethernet cable to the Router (or a computer connected with a USB cable to the USB port of the 3-Port Router).

For a basic network setup, most users only have to use the following screens of the utility:

- **Setup** Enter the settings provided by your ISP.
- **Password** The Router's default password is **admin**. To secure the Router, change the Password from its default.

The Status, DHCP, Log, Security, and Help tabs are also available for basic setup of the Router. For advanced setup of the Router, click the Advanced tab to access these screens: IP Filtering, Port Range Forwarding, Dynamic Routing, Static Routing, DMZ Host, and MAC Address Clone.

Quick and Easy Router Administration

To access the web-based utility of the Router, launch Internet Explorer or Netscape Navigator, and enter the Router's default IP address, **192.168.1.1**, in the Address field, as shown in Figure 9-1, and press **Enter**.

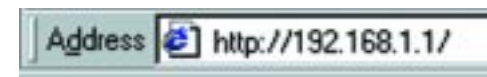

Figure 9-1

A password request page, shown in Figure 9-2 will pop up. (Windows XP users will see a Connect to 192.168.1.1 window, shown in Figure 9-3). Leave the User Name field blank, and enter **admin** in the Password field. Then click the **OK** button.

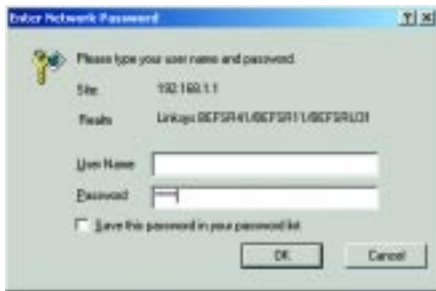

Figure 9-2



Figure 9-3

In this section, you'll find brief descriptions of each web page in the Utility and each page's key functions.

To apply any of the settings you change on a page, click the **Apply** button. To cancel any values you've entered on any page, click the **Cancel** button.

Setup

The Setup screen is the first screen you see when you access the web-based utility. If you have already installed and set up the Router, you have already seen this screen and properly configured all of the screen's values.

- **Host Name & Domain Name** These fields allow you to supply a host and domain name for the Router. Some ISPs require these names as identification. You may have to check with your ISP to see if your broadband Internet service has been configured with a host and domain name. In most cases, leaving these fields blank will work.
- **Firmware Version** This entry shows the version and date of the firmware you are using. Future versions of the Router's firmware will be posted and available for download on the Linksys website at www.linksys.com.

- **Device IP Address and Subnet Mask** The values for the Router's IP Address and Subnet Mask are shown here. The default values are 192.168.1.1 for the Device IP Address and 255.255.255.0 for the Subnet Mask.

- **WAN Connection Type** The Router supports five connection types: DHCP, PPPoE, Static IP, PPTP, and RAS. Each Setup screen and available features will differ depending on what kind of connection type you select.



Note: You can test and see if the settings are correct by successfully connecting to the Internet.

DHCP



Figure 9-4

By default, the Router's WAN Connection Type is set to Obtain an IP automatically, as shown in Figure 9-4, and it should be used only if your ISP supports DHCP.

To apply any of the settings you change on a page, click the **Apply** button. To cancel any values you've entered on any page, click the **Cancel** button. Continue to the "Password" section.

PPPoE

Some DSL-based ISPs use PPPoE (Point-to-Point Protocol over Ethernet) to establish Internet connections for end-users. If you are connected to the Internet through a DSL line, check with your ISP to see if they use PPPoE. If they do, you will have to enable it, as shown in Figure 9-5.



Figure 9-5

User Name and Password Enter the **User Name** and **Password** provided by your ISP.

Connect on Demand and Max Idle Time You can configure the Router to cut your connection with your ISP after a specified period of time (Max Idle Time). If you have been disconnected due to inactivity, Connect on Demand enables the Router to automatically re-establish your connection as soon as you attempt to access the Internet again. If you wish to activate Connect on Demand, click the radio button. If you want your Internet connection to remain on at all times, enter **0** in the Max Idle Time field. Otherwise, enter the number of minutes you want to have elapsed before your Internet access disconnects.

Keep Alive Option and Redial Period This option keeps your PPPoE-enabled Internet access connected indefinitely, even when it sits idle. To use this option, click the radio button next to **Keep Alive**. The default Redial Period is 30 seconds.



Important: For DSL users, if you need to enable PPPoE support, choose **PPPoE**. If you do enable PPPoE, remember to remove any PPPoE applications that are already installed on any of your PCs.

To apply any of the settings you change on a page, click the **Apply** button. To cancel any values you've entered on any page, click the **Cancel** button. Continue to the "Password" section.

Static IP



Figure 9-6

If you are required to use a permanent IP address, then select **Static IP**, as shown in Figure 9-6.

Specify WAN IP Address This is the IP address that the Router has, when seen from the WAN, or the Internet. Your ISP will provide you with the IP Address you need to specify here.

Subnet Mask This is the Router's Subnet Mask, as seen by external users on the Internet (including your ISP). Your ISP will provide you with the Subnet Mask.

Default Gateway Address Your ISP will provide you with the Default Gateway Address.

DNS (Required) Your ISP will provide you with at least one DNS (Domain Name System) Server IP Address.

To apply any of the settings you change on a page, click the **Apply** button. To cancel any values you've entered on any page, click the **Cancel** button. Continue to the "Password" section.

PPTP

Point to Point Tunneling Protocol (PPTP) (shown in Figure 9-7) is a service that applies to connections in Europe only.

Specify WAN IP Address This is the IP address that the Router has, when seen from the WAN, or the Internet. Your ISP will provide you with the IP Address you need to specify here.

Subnet Mask This is the Router's Subnet Mask, as seen by external users on the Internet (including your ISP). Your ISP will provide you with the Subnet Mask.

Default Gateway Address Your ISP will provide you with the Default Gateway Address.

Connect on Demand and Max Idle Time You can configure the Router to cut your connection with your ISP after a specified period of time (Max Idle Time). If you have been disconnected due to inactivity, Connect on Demand enables the Router to automatically re-establish your connection as soon as you attempt to access the Internet again. If you wish to activate Connect on Demand, click the radio button. If you want your Internet connection to remain on at all times, enter **0** in the Max Idle Time field. Otherwise, enter the number of minutes you want to have elapsed before your Internet access disconnects.

Keep Alive Option and Redial Period This option keeps your PPPoE-enabled Internet access connected indefinitely, even when it sits idle. To use this option, click the radio button next to **Keep Alive**. The default Redial Period is 30 seconds.

To apply any of the settings you change on a page, click the **Apply** button. To cancel any values you've entered on any page, click the **Cancel** button. Continue to the "Password" section.



Figure 9-7

RAS

Remote Access Service (RAS) (shown in Figure 9-8) is a service that applies to connections in Singapore only. For users in Singapore, check with Singtel for information on RAS.



Figure 9-8

User Name and Password Enter the **User Name** and **Password** supplied by Singtel.

RAS Plan Select the type of plan you have.

Connect on Demand and Max Idle Time You can configure the Router to cut your connection with your ISP after a specified period of time (Max Idle Time). If you have been disconnected due to inactivity, Connect on Demand enables the Router to automatically re-establish your connection as soon as you attempt to access the Internet again. If you wish to activate Connect on Demand, click the radio button. If you want your Internet connection to remain on at all times, enter **0** in the Max Idle Time field. Otherwise, enter the number of minutes you want to have elapsed before your Internet access disconnects.

Keep Alive Option and Redial Period This option keeps your PPPoE-enabled Internet access connected indefinitely, even when it sits idle. To use this option, click the radio button next to **Keep Alive**. The default Redial Period is 30 seconds.

To apply any of the settings you change on a page, click the **Apply** button. To cancel any values you've entered on any page, click the **Cancel** button. Continue to the "Password" section.

Password

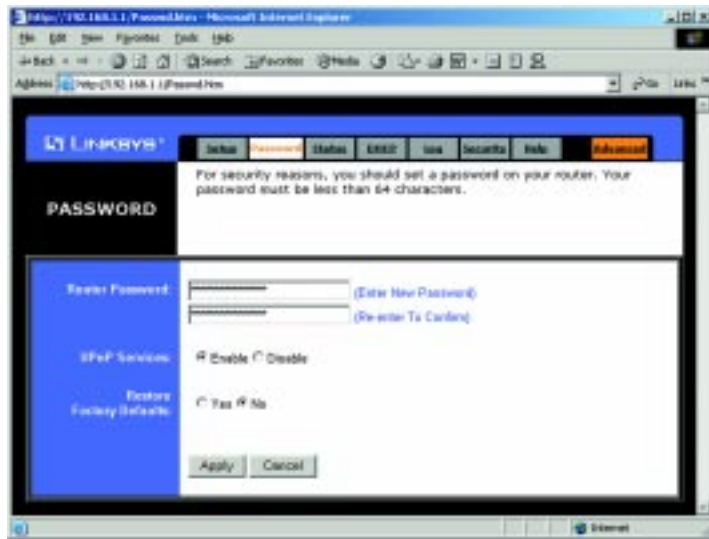

Figure 9-9

You should always have a password set for the Router. This is done through the Password tab, shown in Figure 9-9. The default password is **admin**.

If you don't change the password, all users on your network will be able to access the Router using the default password **admin**.

Universal Plug and Play (UPnP) allows Windows XP to automatically configure the Router for various Internet applications, such as gaming and videoconferencing. Click the radio button next to **Enable** to enable UPnP Services, or **Disable** to disable UPnP Services.

If you select the Restore Factory Default option and click the **Apply** button, you will clear all of the Router's settings.

Do not restore the factory defaults unless you are having difficulties with the Router and have exhausted all other troubleshooting measures. Once the Router is reset, you will have to re-enter all of your configuration data.

To apply any of the settings you change on a page, click the **Apply** button. To cancel any values you've entered on any page, click the **Cancel** button.

Status



Figure 9-10



Note: The information provided and buttons available may vary depending on the Router's settings.

The Status tab, shown in Figure 9-10, displays the Router's status; it reflects the data and selections you've entered using the Setup screen.

All of the information provided on this screen is read-only. To make changes, select the Setup tab.

- **Host Name** This field shows the name of the Router. This entry is necessary for some ISPs.
- **Firmware Version** This field shows the installed version and date of the firmware. Version dates are slightly more accurate than version numbers.
- **Logon** This indicates if you are using a dial-up style connection like PPPoE, RAS, or PPTP. For PPPoE, RAS, or PPTP only, there is a **Connect** button to click if you are disconnected and want to re-establish a connection.
- **LAN** These fields display the current IP Address and Subnet Mask of the Router, as seen by users on your local area network. The DHCP Server field

shows the status of the Router's DHCP server function, which is either enabled or disabled.

- **WAN** These fields display the WAN IP Address, WAN Subnet Mask, and WAN Default Gateway IP Address of the Router, as seen by external users on the Internet. The DNS (Domain Name System) IP Address fields show the IP address(es) of the DNS currently used by the Router. Multiple DNS IP settings are common. In most cases, the first available DNS entry is used.
- **DHCP Release** Click the **DHCP Release** button to release the current IP address of the device connected to the Router's WAN port.
- **DHCP Renew** Click the **DHCP Renew** button to replace the current IP address—of the device connected to the Router's WAN port—with a new IP address.
- **DHCP Clients Table** Click the **DHCP Clients Table** button to view the list of PCs that were given IP addresses by the Router.

DHCP



Figure 9-11

A Dynamic Host Configuration Protocol (DHCP) server automatically assigns an IP address to each PC on your network for you. Unless you already have one, it is highly recommended that you leave the Router enabled as a DHCP server.

- **DHCP Server** DHCP is already enabled by factory default. If you already have a DHCP server on your network, set the Router's DHCP option to **Disable**. Click the **Apply** button. If you disable DHCP, remember to assign a static IP address to the Router.
- **Starting IP Address** Enter a value for the DHCP server to start with when issuing IP addresses. This value must be 192.168.1. 2 or greater, because the default IP address for the Router is **192.168.1.1**.
- **Number of DHCP Users** (Optional) Enter the maximum number of PCs that you want the DHCP server to assign IP addresses to. This number cannot be greater than 253. In order to determine the DHCP IP Address range, add the starting IP address (e.g., 100) to the number of DHCP users. By default, as shown in Figure 9-11, add 100 to 50, and the range is 192.168.1.100 to 192.168.1.149.
- **Client Lease Time** The Client Lease Time is the amount of time a network user will be allowed connection to the Router with their current dynamic IP address. Enter the amount of time, in minutes, that the user will be "leased" this dynamic IP address.
- **DNS** The Domain Name System (DNS) is how the Internet translates domain or website names into Internet addresses or URLs. Your ISP will provide you with at least one DNS Server IP Address. If you wish to use another, type that **IP Address** in one of these fields. You can type up to three DNS Server IP Addresses here. The Router will use these for quicker access to functioning DNS servers.
- **WINS** The Windows Internet Naming Service (WINS) manages each PC's interaction with the Internet. If you use a WINS server, enter that **server's IP Address** here. Otherwise, left this blank.
- **DHCP Clients Table** Click the **DHCP Clients Table** button to show the current DHCP Client data. (This data is stored in temporary memory and changes periodically.)

To apply any of the settings you change on a page, click the **Apply** button. To cancel any values you've entered on any page, click the **Cancel** button.

Log

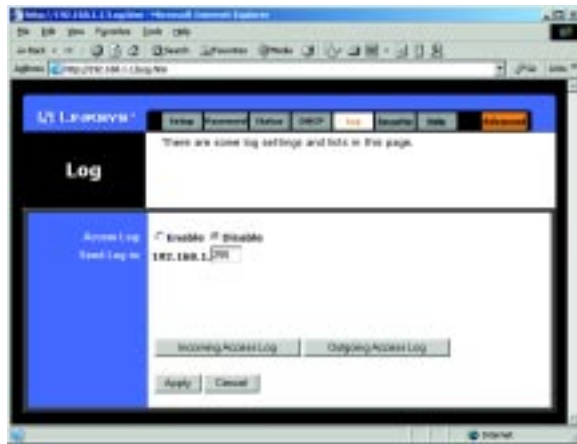

Figure 9-12

The Log tab, shown in Figure 9-12, provides you with a log of all incoming and outgoing URLs or IP addresses for your Internet connection.

To access activity logs, select the **Enable** option next to Access Log. This function can be disabled by clicking the **Disable** radio button.

With logging enabled, you can choose to view temporary logs or have a permanent record, using the Logviewer software. Temporary logs can be accessed from the Log screen by clicking either the **Incoming Access Log** or **Outgoing Access Log** button. The Incoming Access Log gives you a log of all the incoming Internet traffic while the Outgoing Access Log lists all the URLs and IP addresses of Internet sites that users on your network have accessed.

For a permanent record of these logs, Logviewer software must be used. This software is downloadable from the Linksys website, www.linksys.com. The Logviewer saves all incoming and outgoing activity as a permanent file on your PC's hard drive. In the *Send Log to* field, enter the fixed IP address of the PC running the Logviewer software. The Router will now send updated logs to that PC.

To clear any values you've entered on any page, click **Cancel** and re-enter information. To apply any settings you've altered on any page, click the **Apply** button.

Security



Figure 9-13

The Security tab, shown in Figure 9-13, enables configuration of the Router to provide enhanced network security using ZoneAlarm Pro and PC-cillin (each sold separately). The Router provides a built-in Internet NAT firewall. ZoneAlarm Pro enhances the Router's security capabilities for increased protection against hackers and other threats from the Internet. PC-cillin protects against viruses. ZoneAlarm Pro and PC-cillin work independently of each other. For more information on ZoneAlarm Pro, PC-cillin, and DSL or cable network security, please click the on-screen link to the Internet Security Center.

Software Download

Click this button to purchase and download ZoneAlarm Pro and/or PC-cillin at the Internet Security Center. Print the summary page, which contains the license key needed for installation, or write down the license key if you are unable to print the page. You will also be e-mailed a confirmation invoice with the key included. When adding security enhancements to your other networked computers, you can either copy the downloaded files to the other PCs or re-download the software on each individual PC without incurring any more costs.

ZoneAlarm Pro Settings

If you have downloaded ZoneAlarm Pro, complete this section.

License Key Enter the License Key for ZoneAlarm Pro. The License Key will be e-mailed to you after you purchase ZoneAlarm Pro.

Enforce ZoneAlarm Pro Security Check this box to enable ZoneAlarm Pro on the Router. This will require every PC to have ZoneAlarm Pro installed before being allowed to access the Internet (except for exempt computers).

Enforcement Level This sets how often ZoneAlarm Pro will check for unauthorized intrusions. **More Secure** (default setting) enables ZoneAlarm Pro to check frequently. **Conserve Bandwidth** enables ZoneAlarm Pro to check less frequently; this uses less bandwidth. It is recommended to set the Enforcement Level at the More Secure setting unless there is a decrease in the Router's performance.

PC-cillin Settings

If you have downloaded PC-cillin, complete this section.

Enforce PC-cillin Anti-Virus Check this box to enable PC-cillin Anti-Virus on the Router.

Exempt Computers

If you wish to exempt any computers from enforcement of ZoneAlarm Pro and/or PC-cillin, complete this section.

Enable/Disable To enable or disable computer exemptions, click **Enable** or **Disable**.

From IP Address/To IP Address Enter the range of IP addresses for the computers you want to exempt from enforcement of ZoneAlarm Pro and/or PC-cillin.

AOL Parental Controls

Enabling this engages AOL's proprietary "Parental Control" feature. Enabling this will disable all options under the Advanced tab except MAC Address cloning.



Note: AOL Parental Controls are available to AOL customers in the United States Only.

To apply any of the settings you change on a page, click the **Apply** button. To cancel any values you've entered on any page, click the **Cancel** button.

Help

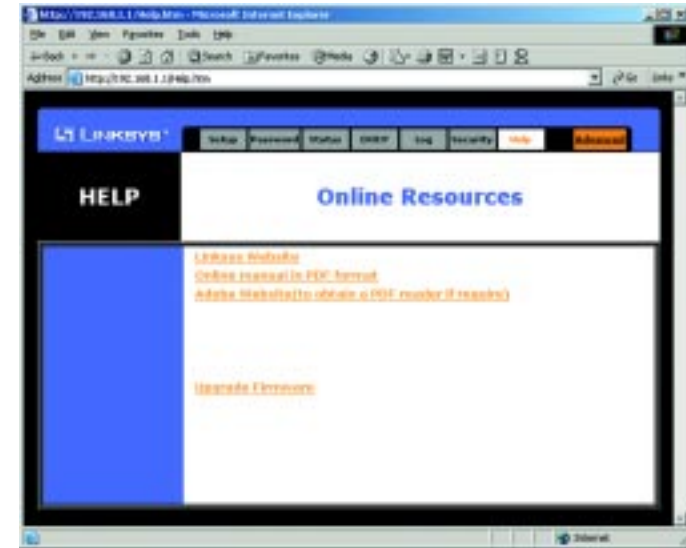



Figure 9-14

Under the Help tab, shown in Figure 9-14, you'll find links to all of the Utility's internal support documentation, including the application that upgrades the Router's firmware.

New firmware versions are posted at www.linksys.com and can be downloaded for free. If the Router can access the Internet already, there's no need to download a newer firmware version, unless that version has a new feature that you want to use. Loading new firmware onto the Router does not enhance the speed or the quality of your connection speed.

See the "IP Filtering" section for directions on how to enable remote firmware upgrades.

To upgrade the Router's firmware:

 **Note:** By upgrading the Router's firmware, you may lose the Router's configuration settings.

1. Select the **Help** tab (see Figure 9-14).
2. Click **Upgrade Firmware** to display a new window (see Figure 9-15).



Figure 9-15

3. Click the **Browse** button to find the firmware upgrade file that you downloaded from the Linksys website and then extracted.
4. Double-click the **firmware file** you downloaded and extracted. Click the **Upgrade** button, and follow the instructions there.

Advanced

The following instructions are for advanced users or users whose setup needs require special configuration. When you click the Advanced tab, you will be able to set up these features. There are six additional tabs available.

- **Filters** - Filters block specific internal users from Internet access and enable Virtual Private Network (VPN) sessions.
- **Forwarding** - Sets up public services on your network.
- **Dynamic Routing** - Sets up the Router so it will automatically adjust to physical changes in the network's layout.
- **Static Routing** - Sets up static routes needed when network information must travel to a specific host or network.
- **DMZ Host** - Allows one local user to be exposed to the Internet for use of special-purpose services such as online gaming or videoconferencing.
- **MAC Address Cloning** - Allows you to "clone" your Ethernet adapter's MAC address onto the Router.

IP Filtering

IP filters block specific internal users from accessing the Internet and enable Virtual Private Network (VPN) sessions. You can set up filters by using IP addresses or network port numbers (or a range of ports).

Setting Up Filters

- To set up a filter using IP addresses, enter the range of IP addresses you wish to filter in the IP address fields. Users who have filtered IP addresses will not be able to access the Internet at all. If you only want to filter one IP address instead of a range of IP addresses, enter the same value into both fields. For instance, if you wish to filter the PC with the IP address of 192.168.1.5, enter **5** into both fields on one line: 192.168.1.5 ~ 192.168.1.5. Click the **Apply** button when you're done.
- To filter users by network port number, enter a network port number or a range of network ports. Enter the port numbers you want to filter in the port numbers fields. Users connected to the Router will no longer be able to access any port number listed there.

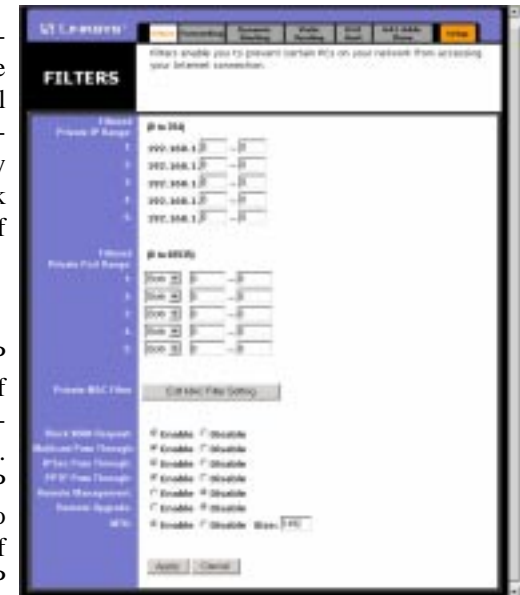

Figure 9-16

Editing MAC Filter Setting

- This feature filters the Ethernet adapter's specific MAC address from going out to the Internet.
- To check your Ethernet adapter's MAC address, run **winiipcfg** or **ipconfig** in the command prompt, depending on which Windows operating system you are using. To set the MAC filter, click the **Edit MAC Filter Setting** button. When a second window appears, select the range in the drop-down box, and at the MAC number prompt, enter the 12-digit MAC address you want to filter. Click the **Apply** button, before closing the window. For information on obtaining a MAC address, go to "Appendix F: Finding the MAC Address and IP Address for Your Ethernet Adapter."

Blocking WAN Requests

- By enabling the Block WAN Request feature, you can prevent your network from being “pinged,” or detected, by other Internet users. The Block WAN Request feature also reinforces your network security by hiding your network ports. Both functions of the Block WAN Request feature make it more difficult for outside users to work their way into your network.
- Click the **Apply** button to save your changes.

Using Multicast Pass Through

- This feature allows for multiple transmissions to specific recipients at the same time. Select **Enable** to support the feature, or **Disable** to keep the Router from multicasting.

Using IPSec Pass Through

- This feature lets you use IPSec Pass Through. To use this feature, click the **Enable** button next to **IPSec Pass Through**, and then the **Apply** button.
- IPSec Pass Through is enabled by default. To disable IPSec Pass Through, click on **Disable** and then the **Apply** button.

Using PPTP Pass Through

- Point-to-Point Tunneling Protocol is the method used to enable VPN sessions. To enable this feature, click the **Enable** button next to **PPTP Pass Through**, and click the **Apply** button.
- PPTP Pass Through is enabled by default. To disable this feature, click on **Disable** next to **PPTP Pass Through**, and then the **Apply** button.

Using Remote Management

- This feature allows you to manage the Router from a remote location, via the Internet. To enable this feature, click on **Enable**, and click the **Apply** button. Remote Management must be activated before you can manage the Router from a remote location.
- To disable Remote Management, click on **Disable**, and click the **Apply** button. If you wish to use this feature on the browser, enter **http://<WAN IP Address>:8080**. (Enter your specific WAN IP Address in place of <WAN IP Address>.)
- To disable this feature, click on **Disable**, and click the **Apply** button.

Using Remote Upgrade

- This feature allows you to upgrade the Router’s firmware from a remote location. To enable Remote Upgrade, click on **Enable**, and then click the **Apply** button. Remote Management must be activated before you can manage the Router from a remote location.

Using MTU (Maximum Transmission Unit)

- This feature specifies the largest packet size permitted for network transmission. Select **Enable** and enter the value desired. It is recommended that you leave this value in the 1200 to 1500 range. For most DSL users, it is recommended to use the value **1492**. By default, MTU is set at **1500** when disabled.

Port Range Forwarding

Port Range Forwarding (shown in Figure 9-17) sets up public services on your network, such as web servers, ftp servers, e-mail servers, or other specialized Internet applications. (Specialized Internet applications are any applications that use Internet access to perform functions such as videoconferencing or online gaming. Some Internet applications may not require any forwarding.) When users send this type of request to your network via the Internet, the Router will forward those requests to the appropriate PC. Before using Forwarding, the Router’s DHCP function must be disabled under the DHCP tab and the Router must be assigned a new static LAN IP address because the IP address may change when using the DHCP server.

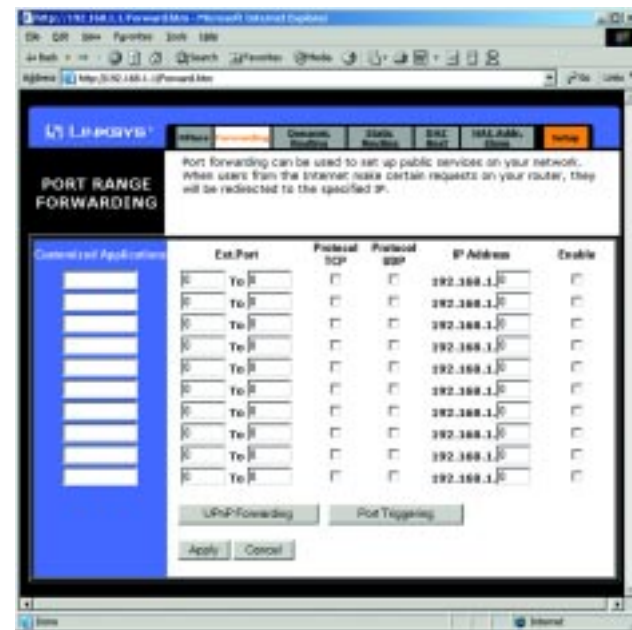

Figure 9-17

If you need to forward all ports to one PC, see the “DMZ” section.

To add a server using Port Range Forwarding:

1. Enter the **name** of the application in the appropriate Customized Applications field.
2. Next to the name of the application, enter the **number** or **range** of the external port(s) used by the server or Internet application in the Ext. Port column. Check with the Internet application software documentation for more information.
3. On the same line, select the protocol **UDP** or **TCP**, or select both protocols.
4. Enter the **IP address** of the server that you want the Internet users to be able to access. To find the IP address, go to “Appendix F: Finding the MAC Address and IP Address for Your Ethernet Adapter.”
5. Check the **Enable** box to enable the services you have defined. Port Range Forwarding will not function if the **Enable** button is left unchecked. This is disabled (unchecked) by default.
6. Configure as many entries as needed—the Router supports up to 10 ranges of ports. Click the **Apply** button when you are done.

UPnP Forwarding

The UPnP Forwarding screen, shown in Figure 9-18, displays preset application settings as well as options for customization of port services for other applications.

The Preset Applications are among the most widely used Internet applications. They include the following:

- **FTP** (File Transfer Protocol) A protocol used to transfer files over a TCP/IP network (Internet, UNIX, etc.). For example, after developing the HTML pages for a website on a local machine, they are typically uploaded to the web server using FTP. FTP includes functions to log onto the network, list directories, and copy files. It can also convert between the ASCII and EBCDIC character codes. FTP operations can be performed by typing commands at a command prompt or via an FTP utility running under a graphical interface such as Windows. FTP transfers can also be initiated from within a web browser by entering the URL preceded by ftp://.

- **Telnet** A terminal emulation protocol commonly used on Internet and TCP/IP-based networks. It allows a user at a terminal or computer to log onto a remote device and run a program.

- **SMTP** (Simple Mail Transfer Protocol) The standard e-mail protocol on the Internet. It is a TCP/IP protocol that defines the message format and the message transfer agent (MTA), which stores and forwards the mail.



Figure 9-18

- **DNS** (Domain Name System) The way that Internet domain names are located and translated into IP addresses. A domain name is a meaningful and easy-to-remember “handle” for an Internet address.
- **TFTP** (Trivial File Transfer Protocol) A version of the TCP/IP FTP protocol that has no directory or password capability.
- **Finger** A UNIX command widely used on the Internet to find out information about a particular user, such as a telephone number, whether the user is currently logged on, and the last time the user was logged on. The person being “fingered” must have placed his or her profile on the system in order for the information to be available. Fingering requires entering the full user@domain address.

- **HTTP** (HyperText Transport Protocol) The communications protocol used to connect to servers on the World Wide Web. Its primary function is to establish a connection with a web server and transmit HTML pages to the client web browser.
- **POP3** (Post Office Protocol 3) A standard mail server commonly used on the Internet. It provides a message store that holds incoming e-mail until users log on and download it. POP3 is a simple system with little selectivity. All pending messages and attachments are downloaded at the same time. POP3 uses the SMTP messaging protocol.
- **NNTP** (Network News Transfer Protocol) The protocol used to connect to Usenet groups on the Internet. Usenet newsreaders support the NNTP protocol.
- **SNMP** (Simple Network Management Protocol) A widely used network monitoring and control protocol. Data is passed from SNMP agents, which are hardware and/or software processes reporting activity in each network device (hub, router, bridge, etc.) to the workstation console used to oversee the network. The agents return information contained in a MIB (Management Information Base), which is a data structure that defines what is obtainable from the device and what can be controlled (turned off, on, etc.).

You must check the **Enable** box to enable the applications you have defined.

To add a server using UPnP Forwarding:

1. Enter the **name** of the application in the appropriate Application Name field.
2. Next to the name of the application, enter the **number** of the external port used by the server in the Ext. Port column. Check with the Internet application software documentation for more information.
3. On the same line, select the protocol **UDP** or **TCP**.
4. Enter the **number** of the internal port used by the server in the Int. Port column. Check with the Internet application software documentation for more information.

5. Enter the IP address of the server that you want the Internet users to be able to access. To find the IP address, go to “Appendix F: Finding the MAC Address and IP Address for Your Ethernet Adapter.”
6. Check the **Enable** box to enable the services you have defined. UPnP Forwarding will not function if the **Enable** button is left unchecked. This is disabled (unchecked) by default.

Port Triggering



Figure 9-19

From the Port Range Forwarding screen, shown in Figure 9-19, click the **Port Triggering** button to allow the Router to watch outgoing data for specific port numbers. The IP address of the computer that sends the matching data is remembered by the Router, so that when the requested data returns through the Router, the data is pulled back to the proper computer by way of IP address and port mapping rules.

1. Enter the **Application Name** of the trigger.
2. Enter the **Trigger Port Range** used by the application. Check with the Internet application for the port number needed.
3. Enter the **Incoming Port Range** used by the application. Check with the Internet application for the port number needed.
4. Click the **Apply** button.

Dynamic Routing

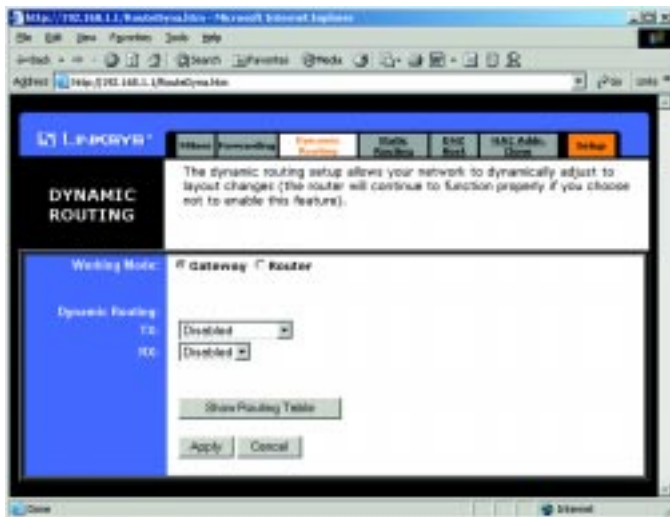

Figure 9-20

With Dynamic Routing (Figure 9-20) you can enable the Router to automatically adjust to physical changes in the network's layout. The Router, using the RIP protocol, determines the network packets' route based on the fewest number of hops between the source and the destination. The RIP protocol regularly broadcasts routing information to other routers on the network. To set up Dynamic Routing:

1. Choose the correct **Working Mode**. **Gateway Mode** should be used if the Router is hosting your network's connection to the Internet. **Router Mode** should be selected if the Router exists on a network with other routers. In Router Mode, any computer connected to the Router will not be able to connect to the Internet unless you have another router function as the Gateway.
2. Choose a **Dynamic Routing path protocol** for either transmission (TX:) or reception (RX:) of network data.

When finished making your changes on this tab, click the **Apply** button to save these changes, or click the **Cancel** button to undo your changes. For further help on this tab, click the **Help** button.

Click the **Show Routing Table** button to open a chart displaying how data is routed through your LAN.

Static Routing



Figure 9-21

If the Router is connected to more than one network, it may be necessary to set up a static route between them. A static route is a pre-determined pathway that network information must travel to reach a specific host or network. From the Static Routing tab, as shown in Figure 9-21, click the **Show Routing Table** button to view the current static routing configuration.

To create a static route entry:

1. Select a **Static Route Entry** from the drop-down list. The Router supports up to 20 static route entries.

To delete a Static Routing entry, select an **entry**, and click the **Delete this entry** button.

2. Enter the following data to create a new static route.

Destination LAN IP: The Destination LAN IP is the address of the remote network or host to which you want to assign a static route. Enter the **IP address** of the host for which you wish to create a static route here. If you are building a route to an entire network, be sure that the network portion of the IP address is set to 0. For example, the Router's standard IP address is 192.168.1.1. Based on this address, the address of the routed network is 192.168.1, with the last digit determining the Router's place on the network. Therefore you would enter the IP address 192.168.1.0 if you wanted to route to the Router's entire network, rather than just to the Router.

Subnet Mask: The Subnet Mask (also known as the Network Mask) determines which portion of an IP address is the network portion, and which portion is the host portion. Take, for example, a network in which the Subnet Mask is 255.255.255.0. This determines (by using the values 255) that the first three numbers of a network IP address identify this particular network, while the last digit (from 1 to 254) identifies the specific host.

Default Gateway: This IP address should be the IP address of the gateway device that allows for contact between the Router and the remote network or host.

Hop Count: This determines the maximum number of steps between network nodes that data packets will travel. A node is any device on the network, such as PCs, print servers, routers, etc.

interface: Select **LAN** or **WAN**, depending on the location of the static route's final destination.

3. When finished making your changes on this tab, click the **Apply** button to save these changes, or click the **Cancel** button to undo your changes.

DMZ Host



Figure 9-22

The DMZ Hosting feature, shown in Figure 9-22, allows one local user to be exposed to the Internet for use of a special-purpose service such as Internet gaming and videoconferencing.

Whereas Port Range Forwarding can only forward a maximum of 10 ranges of ports, DMZ hosting forwards all the ports for one PC at the same time.

- To expose one PC, enter the computer's IP address. To get the IP address of a computer, refer to "Appendix F: Finding the MAC Address and IP Address for Your Ethernet Adapter."
- Deactivate DMZ by entering a **0** in the field.

When finished, click the **Apply** button to save the settings. Otherwise, click the **Cancel** button to undo changes made on this screen.

MAC Address Clone

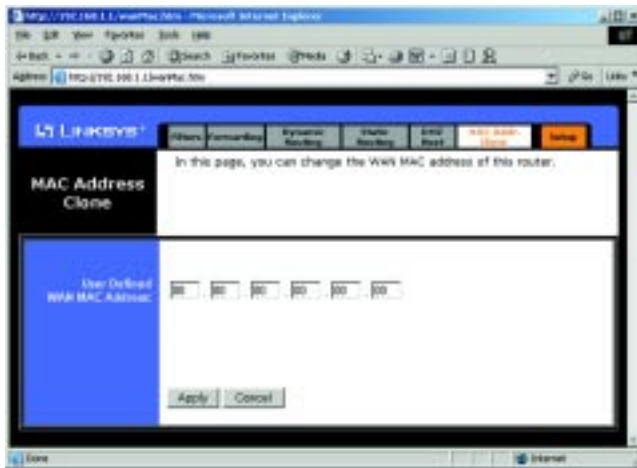

Note: This is a *sample* screen. Please enter the MAC Address for your Network Card/Adapter into this field.

Figure 9-23

The Router's **MAC address** is a 12-digit code assigned to a unique piece of hardware for identification, like a social security number. If your ISP requires MAC address registration, find your adapter's MAC address by following the instructions in "Appendix F: Finding the MAC Address and IP Address for Your Ethernet Adapter."

Enter the 12 digits of your adapter's MAC address in the on-screen fields (see Figure 9-23). This "clones" your network adapter's MAC address onto the Router, so you do NOT have to call your ISP to change the registered MAC address to the Router's MAC address.

When finished making your changes on this tab, click the **Apply** button to save these changes, or click the **Cancel** button to undo your changes.

Appendix A: Troubleshooting

Common Problems and Solutions

This appendix consists of two parts: "Common Problems and Solutions" and "Frequently Asked Questions." Provided are possible solutions to problems regarding the installation and operation of the Router. If your situation is described here, the problem should be solved by applying the corresponding solution. If you can't find an answer here, check the Linksys website at www.linksys.com.

1. I need to set a static IP address on a PC.

The Router, by default, assigns an IP address range of 192.168.1.100 to 192.168.1.150 using the DHCP server on the Router. To set a static IP address, you can only use the ranges 192.168.1.2 to 192.168.1.99 and 192.168.1.151 to 192.168.1.254. Each PC or network device that uses TCP/IP must have a unique address to identify itself in a network. If the IP address is not unique to a network, Windows will generate an IP conflict error message. You can assign a static IP address to a PC by performing the following steps:

For Windows 95, 98, and Me:

- A. Click **Start**, **Settings**, and **Control Panel**. Double-click **Network**.
- B. In *The following network components are installed* box, select the **TCP/IP**-> associated with your Ethernet adapter. If you only have one Ethernet adapter installed, you will only see one TCP/IP line with no association to an Ethernet adapter. Highlight it and click the **Properties** button.
- C. In the *TCP/IP properties* window, select the **IP address** tab, and select **Specify an IP address**. Enter a unique **IP address** that is not used by any other computer on the network connected to the Router. You can only use an IP address in the ranges 192.168.1.2 to 192.168.1.99 and 192.168.1.151 to 192.168.1.254. Make sure that each IP address is unique for each PC or network device.
- D. Click the **Gateway** tab, and in the *New Gateway* prompt, enter **192.168.1.1**, which is the default IP address of the Router. Click the **Add** button to accept the entry.
- E. Click the **DNS** tab, and make sure the **DNS Enabled** option is selected. Enter the **Host** and **Domain** names (e.g., John for Host and home for Domain). Enter the **DNS entry** provided by your ISP. If your ISP has not provided the DNS IP address, contact your ISP to get that information or go to its website for the information.
- F. Click the **OK** button in the *TCP/IP properties* window, and click **Close** or the **OK** button for the Network window.
- G. Restart the computer when asked.

For Windows 2000:

- A. Click **Start, Settings,** and **Control Panel.** Double-click **Network and Dial-Up Connections.**
- B. Right-click the **Local Area Connection** that is associated with the Ethernet adapter you are using, and select the **Properties** option.
- C. In the *Components checked are used by this connection* box, highlight **Internet Protocol (TCP/IP),** and click the **Properties** button. Select **Use the following IP address** option.
- D. Enter a unique **IP address** that is not used by any other computer on the network connected to the Router. You can only use an IP address in the ranges 192.168.1.2 to 192.168.1.99 and 192.168.1.151 to 192.168.1.254.
- E. Enter the Subnet Mask, **255.255.255.0.**
- F. Enter the Default Gateway, **192.168.1.1** (Router's default IP address).
- G. Toward the bottom of the window, select **Use the following DNS server addresses,** and enter the **Preferred DNS server** and **Alternative DNS server** (provided by your ISP). Contact your ISP or go on its website to find the information.
- H. Click the **OK** button in the *Internet Protocol (TCP/IP) Properties* window, and click the **OK** button in the *Local Area Connection Properties* window.
- I. Restart the computer if asked.

For Windows NT 4.0:

- A. Click **Start, Settings,** and **Control Panel.** Double-click the **Network** icon.
- B. Click the **Protocol** tab, and double-click **TCP/IP Protocol.**
- C. When the window appears, make sure you have selected the correct **Adapter** for your Ethernet adapter.
- D. Select **Specify an IP address,** and enter a unique **IP address** that is not used by any other computer on the network connected to the Router. You can only use an IP address in the ranges 192.168.1.2 to 192.168.1.99 and 192.168.1.151 to 192.168.1.254.
- E. Enter the Subnet Mask, **255.255.255.0.**
- F. Enter the Default Gateway, **192.168.1.1** (Router's default IP address).
- G. Click the **DNS** tab, and enter the **Host** and **Domain** names (e.g., John for Host and home for Domain). Under DNS Service Search Order, click the **Add** button. Enter the **DNS IP address** in the DNS Server field, and click the **Add** button. Repeat this action for all DNS IP addresses given by your ISP.
- H. Click the **OK** button in the *TCP/IP Protocol Properties* window, and click the **Close** button in the *Network* window.
- I. Restart the computer if asked.

For Windows XP:

The following instructions assume you are running Windows XP with the default interface. If you are using the Classic interface (where the icons and menus look like previous Windows versions), please follow the instructions for Windows 2000.

- A. Click **Start** and **Control Panel.**
- B. Click the **Network and Internet Connections** icon and then the **Network Connections** icon.
- C. Right-click the **Local Area Connection** that is associated with the Ethernet adapter you are using, and select the **Properties** option.
- D. In the *This connection uses the following items* box, highlight **Internet Protocol (TCP/IP).** Click the **Properties** button.
- E. Enter a unique **IP address** that is not used by any other computer on the network connected to the Router. You can only use an IP address in the ranges 192.168.1.2 to 192.168.1.99 and 192.168.1.151 to 192.168.1.254.
- F. Enter the Subnet Mask, **255.255.255.0.**
- G. Enter the Default Gateway, **192.168.1.1** (Router's default IP address).
- H. Toward the bottom of the window, select **Use the following DNS server addresses,** and enter the **Preferred DNS server** and **Alternative DNS server** (provided by your ISP). Contact your ISP or go on its website to find the information.
- I. Click the **OK** button in the *Internet Protocol (TCP/IP) Properties* window. Click the **OK** button in the *Local Area Connection Properties* window.

2. I want to test my Internet connection.

- A. Check your TCP/IP settings.

For Windows 95, 98, and Me:

Refer to "Appendix D: Installing the TCP/IP Protocol" and "Chapter 7: Configure the PCs" for details. Make sure **Obtain IP address automatically** is selected in the settings.

For Windows 2000:

- Click **Start, Settings,** and **Control Panel.** Double-click **Network and Dial-Up Connections.**
- Right-click the **Local Area Connection** that is associated with the Ethernet adapter you are using, and select the **Properties** option.
- In the *Components checked are used by this connection* box, highlight **Internet Protocol (TCP/IP),** and click the **Properties** button. Make sure that **Obtain an IP address automatically** and **Obtain DNS server address automatically** are selected.

- Click the **OK** button in the *Internet Protocol (TCP/IP) Properties* window, and click the **OK** button in the *Local Area Connection Properties* window.
- Restart the computer if asked.

For Windows XP:

The following instructions assume you are running Windows XP with the default interface. If you are using the Classic interface (where the icons and menus look like previous Windows versions), please follow the instructions for Windows 2000.

- Click **Start** and **Control Panel**.
- Click the **Network and Internet Connections** icon and then the **Network Connections** icon.
- Right-click the **Local Area Connection** that is associated with the Ethernet adapter you are using, and select the **Properties** option.
- In the *This connection uses the following items* box, highlight **Internet Protocol (TCP/IP)**, and click the **Properties** button. Make sure that **Obtain an IP address automatically** and **Obtain DNS server address automatically** are selected.
- Click the **OK** button in the *Internet Protocol (TCP/IP) Properties* window, and click the **OK** button in the *Local Area Connection Properties* window.
- Restart the computer if asked.

For Windows NT 4.0:

- Click **Start**, **Settings**, and **Control Panel**. Double-click the **Network** icon.
- Click the **Protocol** tab, and double-click on **TCP/IP Protocol**.
- When the window appears, make sure you have selected the correct **Adapter** for your Ethernet adapter and set it for **Obtain an IP address from a DHCP server**.
- Click the **OK** button in the *TCP/IP Protocol Properties* window, and click the **Close** button in the *Network* window.
- Restart the computer if asked.

- B. Open a command prompt.
- For **Windows 95, 98, and Me**, please click **Start** and **Run**. In the Open field, type in **command**. Press the **Enter** key or click the **OK** button.
 - For **Windows NT, 2000, and XP**, please click **Start** and **Run**. In the Open field, type **cmd**. Press the **Enter** key or click the **OK** button.

- C. In the command prompt, type **ping 192.168.1.1** and press the **Enter** key.
- If you get a reply, the computer is communicating with the Router.
 - If you do NOT get a reply, please check the cable, and make sure **Obtain an IP address automatically** is selected in the TCP/IP settings for your Ethernet adapter.
- D. In the command prompt, type **ping** followed by your WAN IP address and press the **Enter** key. The WAN IP Address can be found in the web interface of the Router. For example, if your WAN IP address is 1.2.3.4, you would enter **ping 1.2.3.4** and press the **Enter** key.
- If you get a reply, the computer is connected to the Router.
 - If you do NOT get a reply, try the ping command from a different computer to verify that your original computer is not the cause of the problem.
- E. In the command prompt, type **ping www.yahoo.com** and press the **Enter** key.
- If you get a reply, the computer is connected to the Internet. If you cannot open a webpage, try the ping command from a different computer to verify that your original computer is not the cause of the problem.
 - If you do NOT get a reply, there may be a problem with the connection. Try the ping command from a different computer to verify that your original computer is not the cause of the problem.
3. I am not getting an IP address on the WAN with my Internet connection.
- A. Refer to “Problem #2, I want to test my Internet connection” to verify that you have connectivity.
- B. If you need to register the MAC address of your Ethernet adapter with your ISP, please see “Appendix F: Finding the MAC address and IP Address for Your Ethernet Adapter.” If you need to clone the MAC address of your Ethernet adapter onto the Router, see the MAC Address Clone section of “Chapter 6: The Cable/DSL VPN Router’s Web-based Utility” for details.
- C. Make sure you are using the right WAN settings. Contact your ISP to see if your WAN connection type is DHCP, Static IP Address, or PPPoE (commonly used by DSL consumers). Please refer to the Setup section of “Chapter 6: The Cable/DSL VPN Router’s Web-based Utility” for details on WAN settings.
- D. Make sure you have the right cable. Check to see if the WAN column has a solidly lit Link LED.
- E. Make sure the cable connecting from your cable or DSL modem is connected to the Router’s WAN port. Verify that the Status page of the Router’s web interface shows a valid IP address from your ISP.

F. Turn off the computer, Router, and cable/DSL modem. Wait 30 seconds, and then turn on the Router, cable/DSL modem, and computer. Check the Status tab of the Router's web-based utility to see if you get an IP address.

4. I am not able to access the Router's web interface Setup page.

- A. Refer to "Problem #2, I want to test my Internet connection" to verify that your computer is properly connected to the Router.
- B. Refer to "Appendix F: Finding the MAC Address and IP address for Your Ethernet Adapter" to verify that your computer has an IP Address, Subnet Mask, Gateway, and DNS.
- C. Set a static IP address on your system; refer to "Problem #1: I need to set a static IP address."
- D. Refer to "Problem #10: I need to remove the proxy settings or the dial-up pop-up window (for PPPoE users)."

5. I can't get my Virtual Private Network (VPN) working through the Router.

Access the Router's web interface by going to **http://192.168.1.1** or the **IP address** of the Router, and go to the **Advanced => Filter** tab. Make sure you have IPsec pass-through and/or PPTP pass-through enabled.

VPNs that use IPsec with the ESP (Encapsulation Security Payload known as protocol 50) authentication will work fine. At least one IPsec session will work through the Router; however, simultaneous IPsec sessions *may* be possible, depending on the specifics of your VPNs.

VPNs that use IPsec and AH (Authentication Header known as protocol 51) are incompatible with the Router. AH has limitations due to occasional incompatibility with the NAT standard.

Change the IP address for the Router to another subnet to avoid a conflict between the VPN IP address and your local IP address. For example, if your VPN server assigns an IP address 192.168.1.X (X is a number from 1 to 254) and your local LAN IP address is 192.168.1.X (X is the same number used in the VPN IP address), the Router will have difficulties routing information to the right location. If you change the Router's IP address to 192.168.2.1, that should solve the problem. Change the Router's IP address through the Setup tab of the web interface. If you assigned a static IP address to any computer or network device on the network, you need to change its IP address accordingly to 192.168.2.Y (Y being any number from 1 to 254). Note that each IP address must be unique within the network.

Your VPN may require port 500/UDP packets to be passed to the computer that is connecting to the IPsec server. Refer to "Problem #7, I need to set up online game hosting or use other Internet applications" for details.

Check the Linksys website for more information at www.linksys.com.

6. I need to set up a server behind my Router.

To use a server like a web, ftp, or mail server, you need to know the respective port numbers they are using. For example, port 80 (HTTP) is used for web; port 21 (FTP) is used for FTP, and port 25 (SMTP outgoing) and port 110 (POP3 incoming) are used for the mail server. You can get more information by viewing the documentation provided with the server you installed. Follow these steps to set up port forwarding through the Router's web-based utility. We will be setting up web, ftp, and mail servers.

- A. Access the Router's web-based utility by going to **http://192.168.1.1** or the **IP address** of the Router. Go to the **Advanced => Forwarding** tab.
- B. Enter any **name** you want to use for the Customized Application.
- C. Enter the **Ext. Port range** of the service you are using. For example, if you have a web server, you would enter the range 80 to 80.
- D. Check the **protocol** you will be using, TCP and/or UDP.
- E. Enter the **IP address** of the PC or network device that you want the port server to go to. For example, if the web server's Ethernet adapter IP address is 192.168.1.100, you would enter 100 in the field provided. Check "Appendix F: Finding the MAC Address and IP Address for Your Ethernet Adapter" for details on getting an IP address.
- F. Check the **Enable** option for the port services you want to use. Consider the example below:

Customized Application	Ext. Port	TCP	UDP	IP Address	Enable
Web server	80 to 80	X	X	192.168.1.100	X
FTP server	21 to 21	X		192.168.1.101	X
SMTP (outgoing)	25 to 25	X	X	192.168.1.102	X
POP3 (incoming)	110 to 110	X	X	192.168.1.102	X

When you have completed the configuration, click the **Apply** button.

7. I need to set up online game hosting or use other Internet applications.

If you want to play online games or use Internet applications, most will work without doing any port forwarding or DMZ hosting. There may be cases when you want to host an online game or Internet application. This would require you to set up the Router to deliver incoming packets or data to a specific computer. This also applies to the Internet applications you are using. The best way to get the information on what port services to use is to go to the website of the online game or application you want to use. Follow these steps to set up online game hosting or use a certain Internet application:

- A. Access the Router's web interface by going to **http://192.168.1.1** or the **IP address** of the Router. Go to the **Advanced => Forwarding** tab.
- B. Enter any **name** you want to use for the Customized Application.
- C. Enter the **Ext. Port range** of the service you are using. For example, if you want to host Unreal Tournament (UT), you would enter the range 7777 to 27900.
- D. Check the **protocol** you will be using, TCP and/or UDP.
- E. Enter the **IP address** of the PC or network device that you want the port server to go to. For example, if the web server's Ethernet adapter IP address is 192.168.1.100, you would enter 100 in the field provided. Check "Appendix F: Finding the MAC Address and IP Address for Your Ethernet Adapter" for details on getting an IP address.
- F. Check the **Enable** option for the port services you want to use. Consider the example below:

Customized Application	Ext. Port	TCP	UDP	IP Address	Enable
UT	7777 to 27900	X	X	192.168.1.100	X
Halflife	27015 to 27015	X	X	192.168.1.105	X
PC Anywhere	5631 to 5631		X	192.168.1.102	X
VPN IPSEC	500 to 500		X	192.168.1.100	X

When you have completed the configuration, click the **Apply** button.

8. I can't get the Internet game, server, or application to work.

If you are having difficulties getting any Internet game, server, or application to function properly, consider exposing one PC to the Internet using DeMilitarized Zone (DMZ) hosting. This option is available when an application requires too many ports or when you are not sure which port services to use. Make sure you disable all the forwarding entries if you want to successfully use DMZ hosting, since forwarding has priority over DMZ hosting. (In other words, data that enters the Router will be checked first by the forwarding settings. If the port number that the data enters from does not have port forwarding, then the Router will send the data to whichever PC or network device you set for DMZ hosting.) Follow these steps to set DMZ hosting:

- A. Access the Router's web-based utility by going to **http://192.168.1.1** or the **IP address** of the Router. Go to the **Advanced => Forwarding** tab.
- B. Disable or remove the entries you have entered for forwarding. Keep this information in case you want to use it at a later time.
- C. Click the **DMZ Host** tab.
- D. Enter the Ethernet adapter's **IP address** of the computer you want exposed to the Internet. This will bypass the NAT firewall for that computer. Please refer to "Appendix F: Finding the MAC Address and IP Address for Your Ethernet Adapter" for details on getting an IP address.

Once completed with the configuration, click the **Apply** button.

9. I forgot my password, or the password prompt always appears when saving settings to the Router.

Reset the Router to factory default by pressing the **Reset** button for 30 seconds and then releasing it. If you are still getting prompted for a password when saving settings, then perform the following steps:

- A. Access the Router's web interface by going to **http://192.168.1.1** or the **IP address** of the Router. Enter the default password **admin**, and click the **Password** tab.
- B. Enter a **different password** in the Router Password field, and enter the same password in the second field to confirm the password.
- C. Click the **Apply** button.

10. I am a PPPoE user, and I need to remove the proxy settings or the dial-up pop-up window.

If you have proxy settings, you need to disable these on your computer. Because the Router is the gateway for the Internet connection, the computer does not need any proxy settings to gain access. Please follow these directions to verify that you do not have any proxy settings and that the browser you use is set to connect directly to the LAN.

For Microsoft Internet Explorer 5.0 or higher:

- A. Click **Start**, **Settings**, and **Control Panel**. Double-click **Internet Options**.
- B. Click the **Connections** tab.
- C. Click the **LAN settings** button and remove anything that is checked.
- D. Click the **OK** button to go back to the previous screen.
- E. Click the option **Never dial a connection**. This will remove any dial-up pop-ups for PPPoE users.

For Netscape 4.7 or higher:

- A. Start **Netscape Navigator**, and click **Edit**, **Preferences**, **Advanced**, and **Proxies**.
- B. Make sure you have **Direct connection to the Internet** selected on this screen.
- C. Close all the windows to finish.

11. To start over, I need to set the Router to factory default.

Hold the **Reset** button for up to 30 seconds and then release it. This will return the password, forwarding, and other settings on the Router to the factory default settings. In other words, the Router will revert to its original factory configuration.

12. I need to upgrade the firmware.

In order to upgrade the firmware with the latest features, you need to go to the Linksys website and download the latest firmware at www.linksys.com. Follow these steps:

- A. Go to the Linksys website at <http://www.linksys.com> and download the latest firmware.
- B. To upgrade the firmware, follow the steps in the Help section found in “Chapter 9: The Cable/DSL Router’s Web-based Utility.”

13. The firmware upgrade failed, and/or the Diag LED is flashing.

The upgrade could have failed for a number of reasons. Follow these steps to upgrade the firmware and/or make the Diag LED stop flashing:

- A. If the firmware upgrade failed, use the **TFTP** program (it was downloaded along with the firmware). Open the pdf that was downloaded along with the firmware and TFTP program, and follow the pdf’s instructions.
- B. Set a **static IP address** on the PC; refer to “Problem #1, I need to set a static IP address.” Use the following IP address settings for the computer you are using:

IP Address: 192.168.1.50

Subnet Mask: 255.255.255.0

Gateway: 192.168.1.1

- C. Perform the upgrade using the TFTP program or the Router’s web-based utility through its Help tab.

14. My DSL service’s PPPoE is always disconnecting.

PPPoE is not actually a dedicated or always-on connection. The DSL ISP can disconnect the service after a period of inactivity, just like a normal phone dial-up connection to the Internet. There is a setup option to “keep alive” the connection. This may not always work, so you may need to re-establish connection periodically.

- A. To connect to the Router, go to the web browser, and enter **http://192.168.1.1** or the **IP address** of the Router.
- B. Enter the **password**, if asked. (The default password is **admin**.)
- C. In the Setup tab, select the option **Keep Alive**, and set the **Redial Period** option at **20** (seconds).
- D. Click the **Apply** button.
- E. Click the **Status** tab, and click the **Connect** button.
- F. You may see the login status display as **Connecting**. Press the **F5** key to refresh the screen, until you see the login status display as **Connected**.
- G. Click the **Apply** button to continue.

If the connection is lost again, follow steps E to G to re-establish connection.

15. I can't access my email, web, or VPN, or I am getting corrupted data from the Internet.

The Maximum Transmission Unit (MTU) setting may need to be adjusted. By default, the MTU is set at 1500. For most DSL users, it is strongly recommended to use MTU 1492. If you are having some difficulties, perform the following steps:

- A. To connect to the Router, go to the web browser, and enter **http://192.168.1.1** or the **IP address** of the Router.
- B. Enter the password, if asked. (The default password is **admin**.)
- C. Click the **Advanced => Filter** tab.
- D. Look for the MTU option, and select **Enable**. In the Size field, enter **1492**.
- E. Click the **Apply** button to continue.

If your difficulties continue, change the **Size** to different values. Try this list of values, one value at a time, in this order, until your problem is solved:

1462
1400
1362
1300

16. I need to use port triggering.

Port triggering looks at the outgoing port services used and will trigger the Router to open a specific port, depending on which port an Internet application uses. Follow these steps:

- A. To connect to the Router, go to the web browser, and enter **http://192.168.1.1** or the **IP address** of the Router.
- B. Enter the password, if asked. (The default password is **admin**.)
- C. Click the **Advanced => Forwarding** tab, and click the **Port Trigger** button.
- D. Enter any **name** you want to use for the Application Name.
- E. Enter the **Triggered Port Range**. Check with your Internet application provider for more information on which outgoing port services it is using.
- F. Enter the **Incoming Port Range**. Check with your Internet Application provider for more information on which incoming port services are required by the Internet application.

17. The Diag LED stays lit continuously.

- The Diag LED lights up when the device is first powered up. Meantime, the system will boot up itself and check for proper operation. After finishing the checking procedure, the LED turns off to show that the system is working fine. If the LED remains lit after this time, the device is not working properly. Try to flash the firmware by assigning a static IP address to the computer, and then upgrade the firmware. Try using the following settings, IP Address: 192.168.1.50 and Subnet Mask: 255.255.255.0.

18. When I enter a URL or IP address, I get a time-out error or am prompted to retry.

- Check if other PCs work. If they do, ensure that your workstation's IP settings are correct (IP Address, Subnet Mask, Default Gateway, and DNS). Restart the computer that is having a problem.
- If the PCs are configured correctly, but still not working, check the Router. Ensure that it is connected and ON. Connect to it and check its settings. (If you cannot connect to it, check the LAN and power connections.)
- If the Router is configured correctly, check your Internet connection (DSL/cable modem, etc.) to see if it is working correctly. You can remove the Router to verify a direct connection.
- Manually configure the TCP/IP with a DNS address provided by your ISP.
- Make sure that your browser is set to connect directly and that any dial-up is disabled. For Internet Explorer, click **Tools, Internet Options**, and then the **Connection** tab. Make sure that Internet Explorer is set to **Never dial a connection**. For Netscape Navigator, click **Edit, Preferences, Advanced**, and **Proxy**. Make sure that Netscape Navigator is set to **Direct connection to the Internet**.

19. The Full/Col LED keeps flickering continuously.

- Check the Category 5 Ethernet cable and its RJ-45 connectors.
- There may be interference with other network devices. Try removing other PCs or network devices to see if the problem persists. Eliminate each network device one at a time to determine the cause.

Frequently Asked Questions

What is the maximum number of IP addresses that the Router will support? The Router will support up to 253 IP addresses.

Is IPSec Pass-Through supported by the Router? Yes, it is a built-in feature that the Router automatically enables.

Where is the Router installed on the network? In a typical environment, the Router is installed between the cable/DSL modem and the LAN. Plug the Router into the cable/DSL modem's Ethernet port.

Does the Router support IPX or AppleTalk? No. TCP/IP is the only protocol standard for the Internet and has become the global standard for communications. IPX, a NetWare communications protocol used only to route messages from one node to another, and AppleTalk, a communications protocol used on Apple and Macintosh networks, can be used for LAN to LAN connections, but those protocols cannot connect from WAN to LAN.

Does the WAN connection of the Router support 100 Mbps Ethernet? Because of the speed limitations of broadband Internet connections, the Router's current hardware design supports 10 Mbps Ethernet on its WAN port. It does, of course, support 100 Mbps over the auto-sensing Fast Ethernet 10/100 switch on the LAN side of the Router.

What is Network Address Translation and what is it used for? Network Address Translation (NAT) translates multiple IP addresses on the private LAN to one public address that is sent out to the Internet. This adds a level of security since the address of a PC connected to the private LAN is never transmitted on the Internet. Furthermore, NAT allows the Router to be used with low cost Internet accounts, such as DSL or cable modems, when only one TCP/IP address is provided by the ISP. The user may have many private addresses behind this single address provided by the ISP.

Does the Router support any operating system other than Windows 95, Windows 98, Windows 2000, Windows NT, or Windows XP? Yes, but Linksys does not, at this time, provide technical support for setup, configuration or troubleshooting of any non-Windows operating systems.

Does the Router support ICQ send file? Yes, with the following fix: click **ICQ menu -> preference -> connections tab->, and check **I am behind a firewall or proxy**. Then set the firewall time-out to **80** seconds in the firewall setting. The Internet user can then send a file to a user behind the Router.**

I set up an Unreal Tournament Server, but others on the LAN cannot join. What do I need to do? If you have a dedicated Unreal Tournament server running, you need to create a static IP for each of the LAN computers and forward ports 7777, 7778, 7779, 7780, 7781, and 27900 to the IP address of the server. You can also use a port forwarding range of 7777 ~ 27900. If you want to use the UT Server Admin, forward another port (8080 usually works well but is used for remote admin. You may have to disable this.), and then in the [UWeb.WebServer] section of the server.ini file, set the ListenPort to 8080 (to match the mapped port above) and ServerName to the IP assigned to the Router from your ISP.

Can multiple gamers on the LAN get on one game server and play simultaneously with just one public IP address? It depends on which network game or what kind of game server you are using. For example, Unreal Tournament supports multi-login with one public IP.

How do I get *Half-Life: Team Fortress* to work with the Router? The default client port for Half-Life is 27005. The computers on your LAN need to have "+clientport 2700x" added to the HL shortcut command line; the x would be 6, 7, 8, and on up. This lets multiple computers connect to the same server. *One problem:* Version 1.0.1.6 won't let multiple computers with the same CD key connect at the same time, even if on the same LAN (not a problem with 1.0.1.3). As far as hosting games, the HL server does not need to be in the DMZ. Just forward port 27015 to the local IP address of the server computer.

How can I block corrupted FTP downloads? If you are experiencing corrupted files when you download a file with your FTP client, try using another FTP program.

The web page hangs; downloads are corrupt, or nothing but junk characters are being displayed on the screen. What do I need to do? Force your Ethernet adapter to 10Mbps or half duplex mode, and turn off the "Auto-negotiate" feature of your Ethernet adapter as a temporary measure. (Please look at the Network Control Panel in your Ethernet adapter's Advanced Properties tab.) Make sure that your proxy setting is disabled in the browser. Check our website at www.linksys.com for more information.

If all else fails in the installation, what can I do? Reset the Router by holding down the reset button until the Diag LED fully turns on and off. Reset your cable or DSL modem by powering the unit off and then on. Obtain and flash the latest firmware release that is readily available on the Linksys website, www.linksys.com.

How will I be notified of new Router firmware upgrades? All Linksys firmware upgrades are posted on the Linksys website at www.linksys.com, where they can be downloaded for free. The Router's firmware can be upgraded with TFTP programs. If the Router's Internet connection is working well, there is no need to download a newer firmware version, unless that version contains new features that you would like to use. Downloading a more current version of Router firmware will not enhance the quality or speed of your Internet connection, and may disrupt your current connection stability.

Will the Router function in a Macintosh environment? Yes, but the Router's setup pages are accessible only through Internet Explorer 4.0 or Netscape Navigator 4.0 or higher for Macintosh.

I am not able to get the web configuration screen for the Router. What can I do? You may have to remove the proxy settings on your Internet browser, e.g., Netscape Navigator or Internet Explorer. Or remove the dial-up settings on your browser. Check with your browser documentation, and make sure that your browser is set to connect directly and that any dial-up is disabled. Make sure that your browser is set to connect directly and that any dial-up is disabled. For Internet Explorer, click **Tools, Internet Options**, and then the **Connection** tab. Make sure that Internet Explorer is set to **Never dial a connection**. For Netscape Navigator, click **Edit, Preferences, Advanced**, and **Proxy**. Make sure that Netscape Navigator is set to **Direct connection to the Internet**.

What is DMZ Hosting? Demilitarized Zone (DMZ) allows one IP address (computer) to be exposed to the Internet. Some applications require multiple TCP/IP ports to be open. It is recommended that you set your computer with a static IP if you want to use DMZ Hosting. To get the LAN IP address, see "Appendix F: Finding the MAC Address and IP Address for Your Ethernet Adapter."

If DMZ Hosting is used, does the exposed user share the public IP with the Router? No.

Does the Router pass PPTP packets or actively route PPTP sessions? The Router allows PPTP packets to pass through.

Is the Router cross-platform compatible? Any platform that supports Ethernet and TCP/IP is compatible with the Router.

How many ports can be simultaneously forwarded? Theoretically, the Router can establish 520 sessions at the same time, but you can only forward 10 ranges of ports.

Does the Router replace a modem? Is there a cable or DSL modem in the Router? No, this version of the Router must work in conjunction with a cable or DSL modem.

Which modems are compatible with the Router? The Router is compatible with virtually any cable or DSL modem that supports Ethernet.

What are the advanced features of the Router? The Router's advanced features include IP Filtering, Port Range Forwarding, Dynamic Routing, Static Routing, DMZ hosting, and MAC Address Cloning.

What is the maximum number of VPN sessions allowed by the Router? The maximum number depends on many factors. At least one IPSec session will work through the Router; however, simultaneous IPSec sessions *may* be possible, depending on the specifics of your VPNs.

How big is the memory buffer on the Router? 1MB buffer and 512KB flash.

How can I check whether I have static or DHCP IP Addresses? Consult your ISP to obtain this information.

How do I get mIRC to work with the Router? Under the Port Range Forwarding tab, set port forwarding to 113 for the PC on which you are using mIRC.

If your questions are not addressed here, refer to the Linksys website, www.linksys.com.

Appendix B: Glossary

10BaseT - An Ethernet standard that uses twisted wire pairs.

100BaseTX - IEEE physical layer specification for 100 Mbps over two pairs of Category 5 UTP or STP wire.

1000BASE-T - Provides half-duplex (CSMA/CD) and full-duplex 1000 Mbps Ethernet service over Category 5 links as defined by ANSI/TIA/EIA-568-A. Topology rules for 1000BASE-T are the same as those used for 100BASE-T. Category 5 link lengths are limited to 100 meters by the ANSI/TIA/EIA-568-A cabling standard. Only one CSMA/CD repeater will be allowed in a collision domain.

Adapter - Printed circuit board that plugs into a PC to add to capabilities or connectivity to a PC. In a networked environment, a network interface card (NIC) is the typical adapter that allows the PC or server to connect to the intranet and/or Internet.

Auto-negotiate - To automatically determine the correct settings. The term is often used with communications and networking. For example, Ethernet 10/100 cards, hubs, and switches can determine the highest speed of the node they are connected to and adjust their transmission rate accordingly.

Backbone - The part of a network that connects most of the systems and networks together and handles the most data.

Bandwidth - The transmission capacity of a given facility, in terms of how much data the facility can transmit in a fixed amount of time; expressed in bits per second (bps).

Bit - A binary digit. The value—0 or 1—used in the binary numbering system. Also, the smallest form of data.

Boot - To cause the computer to start executing instructions. Personal computers contain built-in instructions in a ROM chip that are automatically executed on startup. These instructions search for the operating system, load it, and pass control to it.

Bottleneck - A traffic slowdown that results when too many network nodes try to access a single node, often a server node, at once.

Bridge - A device that interconnects different networks together.

Broadband - A data-transmission scheme in which multiple signals share the bandwidth of a medium. This allows the transmission of voice, data, and video signals over a single medium. Cable television uses broadband techniques to deliver dozens of channels over one cable.

Browser - A browser is an application program that provides a way to look at and interact with all the information on the World Wide Web or PC. The word “browser” seems to have originated prior to the Web as a generic term for user interfaces that let you browse text files online.

Cable Modem - A device that connects a computer to the cable television network, which in turn connects to the Internet. Once connected, cable modem users have a continuous connection to the Internet. Cable modems feature asymmetric transfer rates: around 36 Mbps downstream (from the Internet to the computer), and from 200 Kbps to 2 Mbps upstream (from the computer to the Internet).

CAT 3 - ANSI/EIA (American National Standards Institute/Electronic Industries Association) Standard 568 is one of several standards that specify “categories” (the singular is commonly referred to as “CAT”) of twisted pair cabling systems (wires, junctions, and connectors) in terms of the data rates that they can sustain. CAT 3 cable has a maximum throughput of 16 Mbps and is usually utilized for 10BaseT networks.

CAT 5 - ANSI/EIA (American National Standards Institute/Electronic Industries Association) Standard 568 is one of several standards that specify “categories” (the singular is commonly referred to as “CAT”) of twisted pair cabling systems (wires, junctions, and connectors) in terms of the data rates that they can sustain. CAT 5 cable has a maximum throughput of 100 Mbps and is usually utilized for 100BaseTX networks.

CAT 5e - The additional cabling performance parameters of return loss and far-end crosstalk (FEXT) specified for 1000BASE-T and not specified for 10BASE-T and 100BASE-TX are related to differences in the signaling implementation. 10BASE-T and 100BASE-TX signaling is unidirectional—signals are transmitted in one direction on a single wire pair. In contrast, Gigabit Ethernet is bi-directional—signals are transmitted simultaneously in both directions on the same wire pair; that is, both the transmit and receive pair occupy the same wire pair.

CPU (Central Processing Unit) - The computing part of the computer. Also called the “processor;” it is made up of the control unit and ALU.

CSMA/CD (Carrier Sense Multiple Access/Collision Detection) - The LAN access method used in Ethernet. When a device wants to gain access to the network, it checks to see if the network is quiet (senses the carrier). If it is not, it waits a random amount of time before retrying. If the network is quiet and two devices access the line at exactly the same time, their signals collide. When the collision is detected, they both back off and each waits a random amount of time before retrying.

Daisy Chain - Connected in series, one after the other. Transmitted signals go to the first device, then to the second, and so on.

Database - A database is a collection of data that is organized so that its contents can easily be accessed, managed, and updated.

Data Packet - One frame in a packet-switched message. Most data communications is based on dividing the transmitted message into packets. For example, an Ethernet packet can be from 64 to 1518 bytes in length.

Default Gateway - The routing device used to forward all traffic that is not addressed to a station within the local subnet.

DHCP (Dynamic Host Configuration Protocol) - A protocol that lets network administrators centrally manage and automate the assignment of Internet Protocol (IP) addresses in an organization's network. Using the Internet's set of protocol (TCP/IP), each machine that can connect to the Internet needs a unique IP address. When an organization sets up its computer users with a connection to the Internet, an IP address must be assigned to each machine. Without DHCP, the IP address must be entered manually at each computer and, if computers move to another location in another part of the network, a new IP address must be entered. DHCP lets a network administrator supervise and distribute IP addresses from a central point and automatically sends a new IP address when a computer is plugged into a different place in the network.

DHCP uses the concept of a “lease” or amount of time that a given IP address will be valid for a computer. The lease time can vary depending on how long a user is likely to require the Internet connection at a particular location. It's especially useful in education and other environments where users change frequently. Using very short leases, DHCP can dynamically reconfigure networks in which there are more computers than there are available IP addresses.

DHCP supports static addresses for computers containing Web servers that need a permanent IP address.

DMZ - (DeMilitarized Zone) allows one IP address (or computer) to be exposed to the Internet. Some applications require multiple TCP/IP ports to be open. It is recommended that you set your computer with a static IP address if you want to use DMZ Hosting.

DNS - The Domain Name System (DNS) is the way that Internet domain names are located and translated into Internet Protocol (IP) addresses. A domain name is a meaningful and easy-to-remember “handle” for an Internet address.

Domain - A subnetwork comprised of a group of clients and servers under the control of one security database. Dividing LANs into domains improves performance and security.

Download - To receive a file transmitted over a network. In a communications session, download means receive, and upload means transmit.

Driver - A workstation or server software module that provides an interface between a network interface card and the upper-layer protocol software running in the computer; it is designed for a specific NIC, and is installed during the initial installation of a network-compatible client or server operating system.

DSSS (Direct-Sequence Spread-Spectrum) - DSSS generates a redundant bit pattern for each bit to be transmitted. This bit pattern is called a chip (or chipping code). The longer the chip, the greater the probability that the original data can be recovered. Even if one or more bits in the chip are damaged during transmission, statistical techniques embedded in the radio can recover the original data without the need for retransmission. To an unintended receiver, DSSS appears as low power wideband noise and is rejected (ignored) by most narrow-band receivers.

Dynamic IP Address - An IP address that is automatically assigned to a client station in a TCP/IP network, typically by a DHCP server. Network devices that serve multiple users, such as servers and printers, are usually assigned static IP addresses.

Dynamic Routing - The ability for a router to forward data via a different route based on the current conditions of the communications circuits. For example, it can adjust for overloaded traffic or failing lines and is much more flexible than static routing, which uses a fixed forwarding path.

Ethernet - IEEE standard network protocol that specifies how data is placed on and retrieved from a common transmission medium. Has a transfer rate of 10 Mbps. Forms the underlying transport vehicle used by several upper-level protocols, including TCP/IP and XNS.

Fast Ethernet - A 100 Mbps technology based on the 10Base-T Ethernet CSMA/CD network access method.

Firewall - A firewall is a set of related programs, located at a network gateway server, that protects the resources of a network from users from other networks. (The term also implies the security policy that is used with the programs.) An enterprise with an intranet that allows its workers access to the wider Internet installs a firewall to prevent outsiders from accessing its own private data resources and for controlling what outside resources to which its own users have access.

Basically, a firewall, working closely with a router, examines each network packet to determine whether to forward it toward its destination.

Firmware - Programming that is inserted into programmable read-only memory, thus becoming a permanent part of a computing device.

Fragmentation - Breaking a packet into smaller units when transmitting over a network medium that cannot support the original size of the packet.

FTP (File Transfer Protocol) - A protocol used to transfer files over a TCP/IP network (Internet, UNIX, etc.). For example, after developing the HTML pages for a website on a local machine, they are typically uploaded to the Web server using FTP.

FTP includes functions to log onto the network, list directories, and copy files. It can also convert between the ASCII and EBCDIC character codes. FTP operations can be performed by typing commands at a command prompt or via an FTP utility running under a graphical interface such as Windows. FTP transfers can also be initiated from within a Web browser by entering the URL preceded with ftp://.

Unlike e-mail programs in which graphics and program files have to be “attached,” FTP is designed to handle binary files directly and does not add the overhead of encoding and decoding the data.

Full Duplex - The ability of a device or line to transmit data simultaneously in both directions.

Gateway - A device that interconnects networks with different, incompatible communications protocols.

Half Duplex - Data transmission that can occur in two directions over a single line, but only one direction at a time.

Hardware - Hardware is the physical aspect of computers, telecommunications, and other information technology devices. The term arose as a way to distinguish the “box” and the electronic circuitry and components of a computer from the program you put in it to make it do things. The program came to be known as the software.

Hub - The device that serves as the central location for attaching wires from workstations. Can be passive, where there is no amplification of the signals; or active, where the hubs are used like repeaters to provide an extension of the cable that connects to a workstation.

IEEE - The Institute of Electrical and Electronics Engineers. The IEEE describes itself as “the world’s largest technical professional society—promoting the development and application of electrotechnology and allied sciences for the benefit of humanity, the advancement of the profession, and the well-being of our members.”

The IEEE fosters the development of standards that often become national and international standards. The organization publishes a number of journals, has many local chapters, and has several large societies in special areas, such as the IEEE Computer Society.

IP Address - In the most widely installed level of the Internet Protocol (Internet Protocol) today, an IP address is a 32-bit binary digit number that identifies each sender or receiver of information that is sent in packets across the Internet. When you request an HTML page or send e-mail, the Internet Protocol part of TCP/IP includes your IP address in the message (actually, in each of the packets if more than one is required) and sends it to the IP address that is obtained by looking up the domain name in the Uniform Resource Locator you requested or in the e-mail address you’re sending a note to. At the other end, the recipient can see the IP address of the Web page requestor or the e-mail sender and can respond by sending another message using the IP address it received.

IPCONFIG - A utility that provides for querying, defining and managing IP addresses within a network. A commonly used utility, under Windows NT and 2000, for configuring networks with static IP addresses.

IPSec - IPSec (**I**nternet **P**rotocol **S**ecurity) is a developing standard for security at the network or packet processing layer of network communication. A big advantage of IPSec is that security arrangements can be handled without requiring changes to individual user computers.

IRQ (**I**nterrupt **R**e**Q**uest) - A hardware interrupt on a PC. There are 16 IRQ lines used to signal the CPU that a peripheral event has started or terminated. Except for PCI devices, two devices cannot use the same line.

ISP - An ISP (Internet service provider) is a company that provides individuals and companies access to the Internet and other related services such as website building and virtual hosting.

LAN - A local area network (LAN) is a group of computers and associated devices that share a common communications line and typically share the resources of a single processor or server within a small geographic area (for example, within an office building).

Latency - The time delay between when the first bit of a packet is received and the last bit is forwarded.

MAC Address - The MAC (Media Access Control) address is a unique number assigned by the manufacturer to any Ethernet networking device, such as a network adapter, that allows the network to identify it at the hardware level.

Mbps (**M**ega**B**its **P**er **S**econd) - One million bits per second; unit of measurement for data transmission.

mIRC - mIRC runs under Windows and provides a graphical interface for logging onto IRC servers and listing, joining, and leaving channels.

Motherboard - A motherboard is the physical arrangement in a computer that contains the computer's basic circuitry and components.

NAT - NAT (Network Address Translation) is the translation of an Internet Protocol address (IP address) used within one network to a different IP address known within another network. One network is designated the inside network and the other is the outside.

NetBEUI (**N**et**B**IOS **E**xtended **U**ser **I**nterface) - The transport layer for NetBIOS. NetBIOS and NetBEUI were originally part of a single protocol suite that was later separated. NetBIOS sessions can be transported over NetBEUI, TCP/IP, and SPX/IPX protocols.

NetBIOS - The native networking protocol in DOS and Windows networks. Although originally combined with its transport layer protocol (NetBEUI), NetBIOS today provides a programming interface for applications at the session layer (layer 5). NetBIOS can ride over NetBEUI, its native transport, which is not routable, or over TCP/IP and IPX/SPX, which are routable protocols.

NetBIOS computers are identified by a unique 15-character name, and Windows machines (NetBIOS machines) periodically broadcast their names over the network so that Network Neighborhood can catalog them. For TCP/IP networks, NetBIOS names are turned into IP addresses via manual configuration in an LMHOSTS file or a WINS server.

There are two NetBIOS modes. The Datagram mode is the fastest mode, but does not guarantee delivery. It uses a self-contained packet with send and receive name, usually limited to 512 bytes. If the recipient device is not listening for messages, the datagram is lost. The Session mode establishes a connection until broken. It guarantees delivery of messages up to 64KB long.

Network - A system that transmits any combination of voice, video, and/or data between users.

Network Mask - also known as the "Subnet Mask."

NIC (**N**etwork **I**nterface **C**ard) - A board installed in a computer system, usually a PC, to provide network communication capabilities to and from that computer system. Also called an adapter.

Notebook (PC) - A notebook computer is a battery-powered personal computer generally smaller than a briefcase that can easily be transported and conveniently used in temporary spaces such as on airplanes, in libraries, at temporary offices, and at meetings. A notebook computer, sometimes called a laptop computer, typically weighs less than five pounds and is three inches or less in thickness.

Packet Filtering - Discarding unwanted network traffic based on its originating address or range of addresses or its type (e-mail, file transfer, etc.).

Partitioning - To divide a resource or application into smaller pieces.

PCI (Peripheral Component Interconnect) - A peripheral bus commonly used in PCs, Macintoshes and workstations. It was designed primarily by Intel and first appeared on PCs in late 1993. PCI provides a high-speed data path between the CPU and peripheral devices (video, disk, network, etc.). There are typically three or four PCI slots on the motherboard. In a Pentium PC, there is generally a mix of PCI and ISA slots or PCI and EISA slots. Early on, the PCI bus was known as a “local bus.”

PCI provides “plug and play” capability, automatically configuring the PCI cards at startup. When PCI is used with the ISA bus, the only thing that is generally required is to indicate in the CMOS memory which IRQs are already in use by ISA cards. PCI takes care of the rest.

PCI allows IRQs to be shared, which helps to solve the problem of limited IRQs available on a PC. For example, if there were only one IRQ left over after ISA devices were given their required IRQs, all PCI devices could share it. In a PCI-only machine, there cannot be insufficient IRQs, as all can be shared.

PCMCIA - The PCMCIA (Personal Computer Memory Card International Association) is an industry group organized in 1989 to promote standards for a credit card-size memory or I/O device that would fit into a personal computer, usually a notebook or laptop computer.

Ping (Packet INternet Groper) - An Internet utility used to determine whether a particular IP address is online. It is used to test and debug a network by sending out a packet and waiting for a response.

Plug-and-Play - The ability of a computer system to configure expansion boards and other devices automatically without requiring the user to turn off the system during installation.

Port - A pathway into and out of the computer or a network device such as a switch or router. For example, the serial and parallel ports on a personal computer are external sockets for plugging in communications lines, modems, and printers.

Port Mirroring - Port mirroring, also known as a roving analysis port, is a method of monitoring network traffic that forwards a copy of each incoming and outgoing packet from one port of a network switch to another port where the packet can be studied. A network administrator uses port mirroring as a diag-

nostic tool or debugging feature, especially when fending off an attack. It enables the administrator to keep close track of switch performance and alter it if necessary. Port mirroring can be managed locally or remotely.

PPPoE (Point to Point Protocol over Ethernet) - A method used mostly by DSL providers for connecting personal computers to a broadband modem for Internet access. It is similar to how a dial-up connection works but at higher speeds and quicker access.

PPTP (Point-to-Point Tunneling Protocol) - A protocol (set of communication rules) that allows corporations to extend their own corporate network through private “tunnels” over the public Internet. Effectively, a corporation uses a wide-area network as a single large local area network. A company no longer needs to lease its own lines for wide-area communication but can securely use the public networks. This kind of interconnection is known as a virtual private network (VPN).

PrintServer - A hardware device that enables a printer to be located anywhere in the network.

RIP (Routing Information Protocol) - A simple routing protocol that is part of the TCP/IP protocol suite. It determines a route based on the smallest hop count between source and destination. RIP is a distance vector protocol that routinely broadcasts routing information to its neighboring routers and is known to waste bandwidth. AppleTalk, DECnet, TCP/IP, NetWare, and VINES all use incompatible versions of RIP.

RJ-11 (Registered Jack-11) - A telephone connector that holds up to six wires. The RJ-11 is the common connector used to plug a telephone into a wall.

RJ-45 - A connector similar to a telephone connector that holds up to eight wires, used for connecting Ethernet devices.

Router - Protocol-dependent device that connects subnetworks together. Routers are useful in breaking down a very large network into smaller subnetworks; they introduce longer delays and typically have much lower throughput rates than bridges.

Server - Any computer whose function in a network is to provide user access to files, printing, communications, and other services.

Software - Instructions for the computer. A series of instructions that performs a particular task is called a “program.” The two major categories of software are “system software” and “application software.” System software is made up of control programs such as the operating system and database management system (DBMS). Application software is any program that processes data for the user.

A common misconception is that software is data. It is not. Software tells the hardware how to process the data.

SOHO (Small Office/Home Office) - Market segment of professionals who work at home or in small offices.

Static IP Address - A permanent IP address that is assigned to a node in a TCP/IP network.

Static Routing - Forwarding data in a network via a fixed path. Static routing cannot adjust to changing line conditions as can dynamic routing.

Storage - The semi-permanent or permanent holding place for digital data.

STP (Shielded Twisted Pair) - Telephone wire that is wrapped in a metal sheath to eliminate external interference.

Subnet Mask - The method used for splitting IP networks into a series of subgroups, or subnets. The mask is a binary pattern that is matched up with the IP address to turn part of the host ID address field into a field for subnets.

Swapping - Replacing one segment of a program in memory with another and restoring it back to the original when required.

Switch – 1. A data switch connects computing devices to host computers, allowing a large number of devices to share a limited number of ports. 2. A device for making, breaking, or changing the connections in an electrical circuit.

TCP (Transmission Control Protocol) - A method (protocol) used along with the Internet Protocol (Internet Protocol) to send data in the form of message units between computers over the Internet. While IP takes care of handling the actual delivery of the data, TCP takes care of keeping track of the individual units of data (called packets) that a message is divided into for efficient routing through the Internet.

TCP/IP - Transmission Control Protocol/Internet Protocol (TCP/IP) is the basic communication language or protocol of the Internet. It can also be used as a communications protocol in a private network (either an intranet or an extranet). When you are set up with direct access to the Internet, your computer is provided with a copy of the TCP/IP program just as every other computer that you may send messages to or get information from also has a copy of TCP/IP.

TFTP (Trivial File Transfer Protocol) - A version of the TCP/IP FTP protocol that has no directory or password capability.

Throughput - The amount of data moved successfully from one place to another in a given time period.

Topology - A network’s topology is a logical characterization of how the devices on the network are connected and the distances between them. The most common network devices include hubs, switches, routers, and gateways. Most large networks contain several levels of interconnection, the most important of which include edge connections, backbone connections, and wide-area connections.

TX Rate – Transmission Rate.

UDP (User Datagram Protocol) - A communications method (protocol) that offers a limited amount of service when messages are exchanged between computers in a network that uses the Internet Protocol (IP). UDP is an alternative to the Transmission Control Protocol (TCP) and, together with IP, is sometimes referred to as UDP/IP. Like the Transmission Control Protocol, UDP uses the Internet Protocol to actually get a data unit (called a datagram) from one computer to another. Unlike TCP, however, UDP does not provide the service of dividing a message into packets (datagrams) and reassembling it at the other end. Specifically, UDP doesn’t provide sequencing of the packets that the data arrives in. This means that the application program that uses UDP must be able to make sure that the entire message has arrived and is in the right order. Network applications that want to save processing time because they have very small data units to exchange (and therefore very little message reassembling to do) may prefer UDP to TCP.

Upgrade - To replace existing software or firmware with a newer version.

Upload - To send a file transmitted over a network. In a communications session, upload means transmit, and download means receive.

URL (Uniform Resource Locator) - The address that defines the route to a file on the Web or any other Internet facility. URLs are typed into the browser to access Web pages, and URLs are embedded within the pages themselves to provide the hypertext links to other pages.

UTP - Unshielded twisted pair is the most common kind of copper telephone wiring. Twisted pair is the ordinary copper wire that connects home and many business computers to the telephone company. To reduce crosstalk or electromagnetic induction between pairs of wires, two insulated copper wires are twisted around each other. Each signal on twisted pair requires both wires. Since some telephone sets or desktop locations require multiple connections, twisted pair is sometimes installed in two or more pairs, all within a single cable.

VLAN (Virtual LAN) - A logical association that allows users to communicate as if they were physically connected to a single LAN, independent of the actual physical configuration of the network.

Virtual Server - Multiple servers that appear as one server, or one system image, to the operating system or for network administration.

Wake-on-LAN - Wake on LAN is a technology that allows a network professional to remotely power on a computer or to wake it up from *sleep mode*.

WAN - A communications network that covers a wide geographic area, such as a state or country.

WEP (Wired Equivalent Privacy) - A data privacy mechanism based on a 64-bit shared key algorithm, as described in the IEEE 802.11 standard.

WINIPCFG - Configuration utility based on the Win32 API for querying, defining, and managing IP addresses within a network. A commonly used utility for configuring networks with static IP addresses.

Workgroup - Two or more individuals that share files and databases.

Appendix C: How to Ping Your ISP's E-mail & Web Addresses

Virtually all Internet addresses are configured with words or characters (e.g., *www.linksys.com*, *www.yahoo.com*, etc.) In actuality, however, these Internet addresses are assigned to IP addresses, which are the true addresses on the Internet. For example, *www.linksys.com* is actually 216.23.162.142. Type it into your web browser and you will wind up at the Linksys home page every time. There are servers that translate the URL to an IP address; this is called Domain Name System (DNS).

IP and web addresses, however, can sometimes be long and hard to remember. Because of this, certain ISPs will shorten their server addresses to single words or codes on their users' web browser or e-mail configurations. If your ISP's e-mail and web server addresses are configured with single words (*www*, *e-mail*, *home*, *pop3*, etc.) rather than whole Internet addresses or IP addresses, the Router may have problems sending or receiving mail and accessing the Internet. This happens because the Router has not been configured by your ISP to accept their abbreviated server addresses.

The solution is to determine the true web addresses behind your ISP's code words. You can determine the IP and web addresses of your ISP's servers by "pinging" them.



Important: If you don't have your ISP's web and e-mail IP addresses, you *must* either get them from your ISP or follow these steps *prior* to connecting your Cable/DSL Router to your network.

Step One: Pinging an IP Address

The first step to determining your ISP's web and e-mail server address is to ping its IP address.

1. **Power on the computer and the cable or DSL modem**, and restore the network configuration set by your ISP if you have since changed it.
2. **Click Start**, then **Run**, and type **command**. This will bring up the DOS window.
3. **At the DOS command prompt**, type **ping mail** (assuming that the location for which you're trying to find an IP address is configured as *mail*). Press **Enter**. Information such as the following data, taken from a ping of Microsoft Network's e-mail server, will be displayed.

```
C:\>ping mail

Pinging mail [24.53.32.4] with 32 bytes of data:

Reply from 24.53.32.4: bytes=32 time<10ms TTL=128
Reply from 24.53.32.4: bytes=32 time<10ms TTL=128
Reply from 24.53.32.4: bytes=32 time<10ms TTL=128
Reply from 24.53.32.4: bytes=32 time<10ms TTL=128

Ping statistics for 24.53.32.4:
    Packets: Sent = 4, Received = 4, Lost = 0 (0%
    loss),
    Approximate round trip times in milli-seconds:
        Minimum = 0ms, Maximum = 0ms, Average = 0ms
```

Figure C-1

4. **Write down the IP address returned by the ping command.** (In the example above: 24.53.32.4.) This IP address is the actual IP address of the server *mail*, or any other word or value you have pinged.

Step Two: Pinging for a Web Address

While the IP address returned above would work as your e-mail server address, it may not be permanent. IP addresses change all the time. Web addresses, however, usually don't. Because of this, you're likely to have fewer problems by configuring your system with web addresses rather than IP addresses. Follow the instructions below to find the web address assigned to the IP address you just pinged.

1. **At the DOS command prompt**, type **ping -a 24.53.32.4**, where 24.53.32.4 is the IP address you just pinged. Information such as the following data will be displayed.

```
C:\>ping -a 24.53.32.4

Pinging mail.msnv3.occa.home.com [24.53.32.4] with
32 bytes of data:

Reply from 24.53.32.4: bytes=32 time<10ms TTL=127
Reply from 24.53.32.4: bytes=32 time<10ms TTL=127
Reply from 24.53.32.4: bytes=32 time<10ms TTL=127
Reply from 24.53.32.4: bytes=32 time<10ms TTL=127

Ping statistics for 24.53.32.4:
    Packets: Sent = 4, Received = 4, Lost = 0 (0%
    loss),
    Approximate round trip times in milli-seconds:
        Minimum = 0ms, Maximum = 0ms, Average = 0ms
```

Figure C-2

2. **Write down the web address returned by the ping command** (In the example in Figure C-2: *mail.msnv3.occa.home.com* is the web address). This web address is the web address assigned to the IP address you just pinged. While the IP address of *mail* could conceivably change, it is likely that this web address will not.
3. **Replace your ISP's abbreviated server address** with this extended web address in the corresponding Internet application (web browser, e-mail application, etc.).

Once you have replaced the brief server address with the true server address, the Router should have no problem accessing the Internet through that Internet application.

Appendix D: Installing the TCP/IP Protocol

Follow these instructions to install the TCP/IP protocol on one of your PCs *only* after a network card has been successfully installed inside the PC. These instructions are for Windows 95, Windows 98, and Windows Me. For TCP/IP setup under Windows NT, 2000, and XP, see your Windows documentation or the Help feature.

1. Click the **Start** button. Choose **Settings** and then **Control Panel**.
2. Double-click on the **Network** icon to bring up your Network window. Select the **Configuration** tab, as shown in Figure D-1.



Figure D-1

3. Click the **Add** button.
4. Double-click on **Protocol**.
5. Highlight **Microsoft** under the list of manufacturers.

6. Find and double-click **TCP/IP** in the list to the right (see Figure D-2).



Figure D-2

7. After a few seconds, the main Network window will appear. The TCP/IP Protocol should now be listed, as shown in Figure D-3.

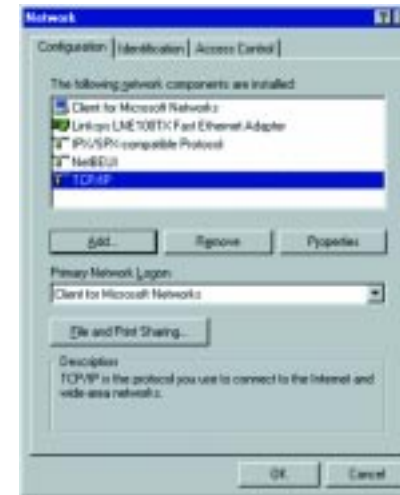

Figure D-3

8. Click the **OK** button. Windows may ask for original Windows installation files. Supply them as needed, e.g., c:\windows\options\cabs, D:\win98, D:\win95.
9. Windows will ask you to restart the PC. Click the **Yes** button.

The TCP/IP installation is now complete.

Appendix E: Twisted-Pair Cabling

There are different grades, or “categories,” of twisted-pair cabling. Category 5 is the most reliable and most highly recommended. Category 3 is a good second choice. Straight-through cables are used for connecting computers to a hub. Crossover cables are used for connecting a hub to another hub (there is an exception: some hubs have a built-in uplink port that is crossed internally; this allows you to link or connect hubs together with a straight-through cable instead).

You can buy pre-made Category 5 cables, or cut and crimp your own. Category 5 cables can be purchased or crimped as either straight-through or crossover.

RJ-45 Color Chart	
Wire 1	White with an Orange Stripe
Wire 2	Orange
Wire 3	White with a Green Stripe
Wire 4	Blue
Wire 5	White with a Blue Stripe
Wire 6	Green
Wire 7	White with a Brown Stripe
Wire 8	Brown

Inside a Category 5 cable are eight thin, color-coded wires inside that run from one end of the cable to the other. All eight wires are used. In a straight-through cable, wires 1, 2, 3, and 6 at one end of the cable are also wires 1, 2, 3, and 6 at the other end. In a crossover cable, the order of the wires change from one end to the other: wire 1 becomes 3, and 2 becomes 6. See Figures E-3 and E-4 on the next page for more detailed information on straight-through and crossover cabling.

straight-through cable		crossed cable	
Wire	Becomes	Wire	Becomes
1	1	1	3
2	2	2	6
3	3	3	1
6	6	6	2

To determine which wire is wire number 1,

hold the cable so that the end of the plastic RJ-45 tip (the part that goes into a wall jack first) is facing away from you. Face the clip down so that the copper side faces up (the springy clip will now be parallel to the floor). When looking down on the copper side, wire 1 will be on the far left.

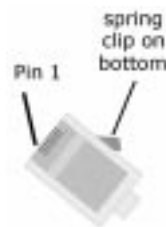

Figure E-2

Crimping Your Own Network Cables

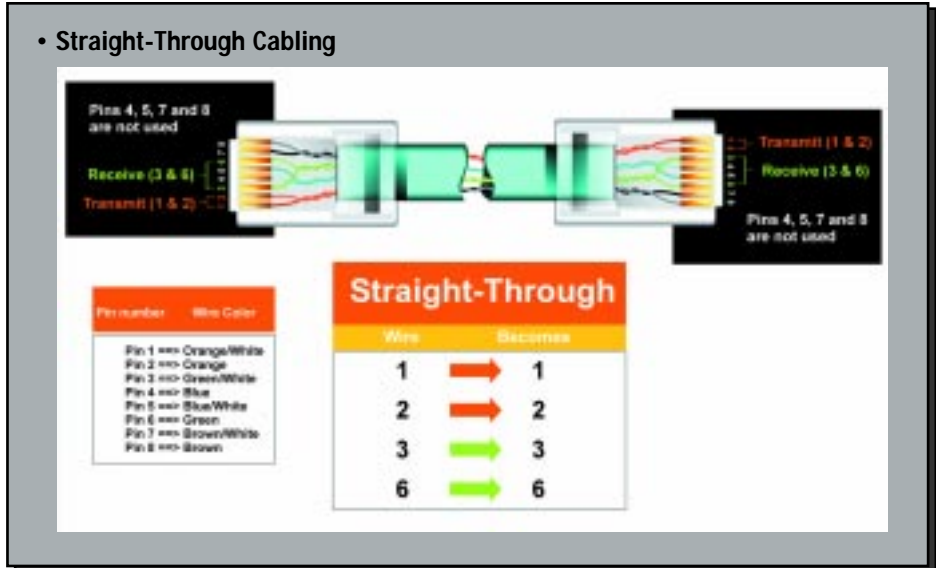

Figure E-3

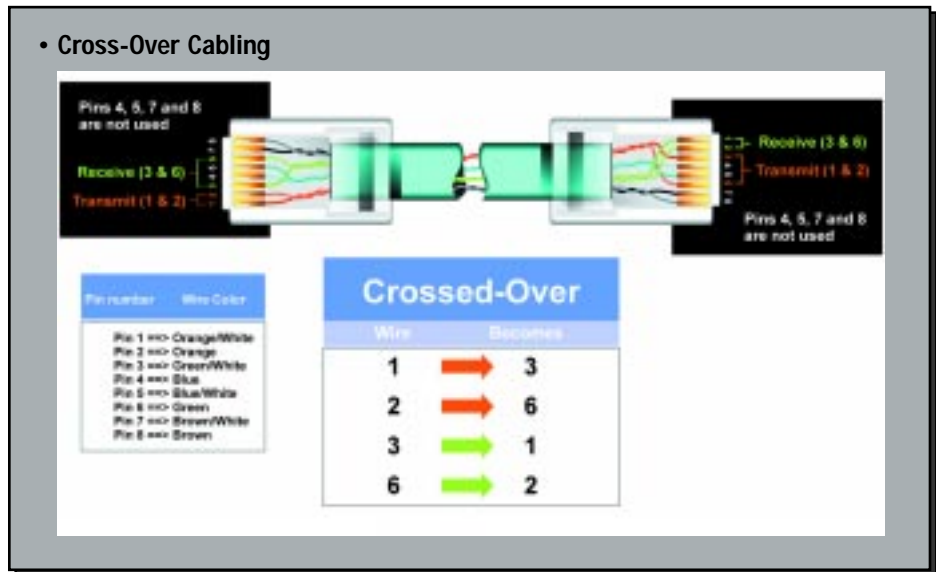

Figure E-4

Appendix F: Finding the MAC Address and IP Address for Your Ethernet Adapter

This section describes how to find the MAC address for your Ethernet adapter to do either MAC Filtering or MAC Address Cloning for the Router and ISP. You can also find the IP address of your computer's Ethernet adapter. The IP address is used for filtering, forwarding, and DMZ. Follow the steps in this appendix to find the MAC address or IP address for your adapter in Windows 95, 98, Me, NT, 2000, and XP.

For Windows 95, 98, and Me:

1. Click on **Start** and **Run**. In the Open field, enter **winipcfg**, as shown in Figure F-1. Then press the **Enter** key or the **OK** button.



Figure F-1

2. When the IP Configuration window appears, select the Ethernet adapter you are using to connect to the Router via a CAT 5 Ethernet cable, as shown in Figure F-2.



Figure F-2

3. Write down the Adapter Address as shown on your computer screen (see Figure F-3). This is the MAC address for your Ethernet adapter and will be shown as a series of numbers and letters.

The MAC address/Adapter Address is what you will use for MAC Address Cloning or MAC Filtering.



Figure F-3

The example in Figure F-3 shows the IP address of your Ethernet adapter as 192.168.1.100. Your computer may show something different.



Note: The MAC address is also called the Adapter Address.

For Windows NT, 2000, and XP:

The following steps show an alternative way of obtaining the MAC address and IP address for your Ethernet adapter.

1. Click on **Start** and **Run**. In the Open field, enter **cmd**, as shown in Figure F-4. Press the **Enter** key or click the **OK** button.

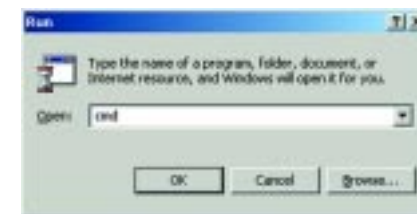

Figure F-4

2. In the command prompt, enter **ipconfig /all**. Then press the **Enter** key.

```

C:\>ipconfig /all

Windows 2000 IP Configuration

Host Name . . . . . : 
Primary DNS Suffix . . . . . : 
Node Type . . . . . : Hybrid
IP Routing Enabled. . . . . : No
WINS Proxy Enabled. . . . . : No

Ethernet adapter Local Area Connection:

   Connection-specific DNS Suffix  . : 
   Description . . . . . : Linksys LNE100TE(G05) Fast Ethernet A
   adapter
   Physical Address. . . . . : 00-00-00-00-00-00
   DSCP Enabled. . . . . : Yes
   Autocconfiguration Enabled . . . . : Yes
   IP Address. . . . . : 192.168.1.100
   Subnet Mask . . . . . : 255.255.255.0
   Default Gateway . . . . . : 192.168.1.1
   DHCP Server . . . . . : 192.168.1.1
   DNS Servers . . . . . : 192.168.1.1

   Primary WINS Server . . . . . : 192.168.1.1
   Secondary WINS Server . . . . . : 
   Lease Obtained. . . . . : Monday, February 11, 2002 2:31:47 PM
   Lease Expires . . . . . : Tuesday, February 12, 2002 2:31:47 PM
  
```

Figure F-5

3. Write down the Physical Address as shown on your computer screen (Figure F-5); it is the MAC address for your Ethernet adapter. This will appear as a series of letters and numbers.

The MAC address/Physical Address is what you will use for MAC Address Cloning or MAC Filtering.



Note: The MAC address is also called the Physical Address.

The example in Figure F-5 shows the IP address of your Ethernet adapter as 192.168.1.100. Your computer may show something different.

When entering the information using the Router's web-based utility, you will type the **12-digit MAC address** in this format, XXXXXXXXXXXXX *without the hyphens* for MAC Filtering. See Figure F-6.

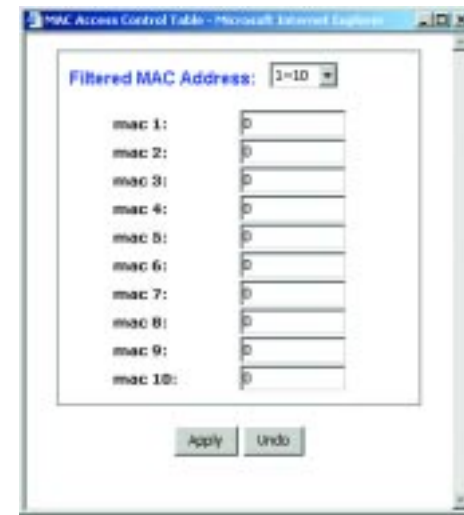

Figure F-6

When entering information for MAC Address Cloning, type the **12-digit MAC address** (see Figure F-7).



Figure F-7

Appendix G: Setting Up AOL® Broadband Cable & DSL

This document provides instructions for setting up the Router using firmware version 1.43 or above to work with AOL Broadband via a Cable or DSL connection. This Router's AOL Parental Controls feature is available for AOL customers in the US only. Please follow the instructions in the appropriate section below to configure for AOL Broadband for the type of broadband connection you have.



Note: You must install AOL 7.0 or above to all computers using AOL Services. Those with earlier versions of AOL can find details at AOL Keyword: Linksys Setup.



Note: Some of the screens in this section may look slightly different than what appears on your screen.

AOL Broadband via Cable

1. Open your web browser. Enter **http://192.168.1.1** in the web browser's Address field, as shown in Figure G-1, and press the **Enter** key.

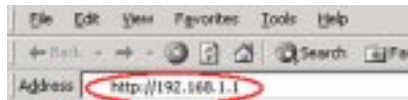

Figure G-1

2. A password request page, shown in Figure G-2 will appear. (Windows XP users will see a Connect to 192.168.1.1 window slightly different from that shown). Leave the User Name field blank, and enter **admin** in the Password field. Then click the **OK** button.



Figure G-2

3. From the *Setup* screen that appears, shown in Figure G-3, select **Obtain an IP automatically** from the WAN Connection Type dropdown menu. Then, click the **Security** tab.



Figure G-3

4. Select **Enable** for AOL Parental Controls from the *Security* tab, shown in Figure G-4, and click the **OK** button on the screen that appears. Enabling this will disable all options under the *Advanced* tab except **MAC Address cloning**.

Then, click the **OK** button to save these settings. Click the **X** button on the top right side of the window to close it.



Figure G-4



Note: AOL Parental Controls are available to AOL customers in the United States Only.

AOL Broadband via DSL

1. Open your web browser. Enter **http://192.168.1.1** in the web browser's Address field, as shown in Figure G-5, and press the **Enter** key.

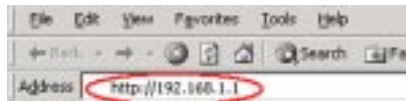

Figure G-5

2. A password request page, shown in Figure G-6 will appear. (Windows XP users will see a Connect to 192.168.1.1 window slightly different from that shown). Leave the User Name field blank, and enter **admin** in the Password field. Then click the **OK** button.



Figure G-6

3. From the *Setup* screen that appears, shown in Figure G-7, select **PPPoE** from the WAN Connection Type drop-down menu. Enter **america online** for the User Name. In the password field, multiple asterisks will appear. Keep these settings and click the **Apply** button to save them. Click the **X** button on the top right side of the window to close it.



Figure G-7

Appendix H: 4-Port Router Specifications

Model Number	BEFSR41 ver. 2
Standards	IEEE 802.3 (10BaseT), IEEE 802.3u (100BaseTX)
Protocol	CSMA/CD
Ports	
LAN:	Four 10/100 RJ-45 switched ports (and shared uplink)
WAN:	One 10Base-T Ethernet RJ-45 port for the cable or DSL modem
Speed	
LAN:	10/100Mbps
WAN:	10Mbps
Cabling Type	
10BaseT:	UTP Category 3 or better
100BaseTX:	UTP Category 5 or better
Topology	Star
LED Indicators	Power
LAN:	Link/Act, Full/Col, 100
WAN:	Link, Act, Diag

4-Port Environmental Specifications

Dimensions	7.31" x 6.16" x 1.88" (186 mm x 154 mm x 48 mm)
Unit Weight	13.4 oz. (0.42 kg)
Power Input	External, 9V AC, 1 Amp
Certifications	FCC Class B, CE Mark
Operating Temperature	0°C to 40°C (32°F to 104°F)
Storage Temperature	-20°C to 70°C (-4°F to 158°F)
Operating Humidity	10% to 85%, Non-condensing
Storage Humidity	5% to 90%, Non-condensing

Appendix I: 1-Port Router Specifications

Model Number	BEFSR11, ver. 2
Standards	IEEE 802.3 (10BaseT), IEEE 802.3u (100BaseTX)
Protocol	CSMA/CD
Ports	
LAN:	One 10BaseT/100BaseTX RJ-45 port
WAN:	One 10BaseT Broadband Uplink port
Speed	
WAN:	10Mbps (10BaseT Ethernet)
LAN:	10Mbps (10BaseT Ethernet) or 100Mbps (100BaseTX Fast Ethernet)
Cabling Type	
10BaseT:	UTP Category 3 or better
100BaseTX:	UTP Category 5 or better
Topology	Star
LED Indicators	Power
LAN:	Link/Act, Full/Col, 100
WAN:	Link, Act, Diag

1-Port Environmental Specifications

Dimensions	7.31" x 6.16" x 1.88" (186 mm x 154 mm x 48 mm)
Unit Weight	12.6 oz. (0.35 kg)
Power Input	External, 7.5V DC, 700 mA
Certifications	FCC Class B, CE Mark
Operating Temperature	0°C to 40°C (32°F to 104°F)
Storage Temperature	-20°C to 70°C (-4°F to 158°F)
Operating Humidity	10% to 85%, Non-condensing
Storage Humidity	5% to 90%, Non-condensing

Appendix J: 3-Port Router Specifications

Model Number	BEFSRU31
Standards	IEEE 802.3 (10BaseT), IEEE 802.3u (100BaseTX), USB Specification 1.0 & 1.1
Protocol	CSMA/CD
Ports	
LAN:	Three 10/100 RJ-45 Switched ports (and shared uplink), One USB port
WAN:	One 10Base-T Ethernet RJ-45 port for the cable or DSL modem
Speed	
LAN (Ethernet):	10/100Mbps
WAN (Ethernet):	10Mbps
USB:	Up to 12Mbps
Cabling Type	
10BaseT:	UTP Category 3 or better
100BaseTX:	UTP Category 5 or better
USB:	Standard USB cable
Topology	Star
LED Indicators	Power
LAN:	Link/Act, Full/Col, 100
WAN:	Link, Act, Diag
USB:	USB

3-Port Environmental Specifications

Dimensions	7.31" x 6.16" x 1.88" (186 mm x 154 mm x 48 mm)
Unit Weight	13.4 oz. (0.42 kg)
Power Input	External, 9V AC, 1 Amp
Certifications	FCC Class B, CE Mark
Operating Temperature	0°C to 40°C (32°F to 104°F)
Storage Temperature	-20°C to 70°C (-4°F to 158°F)
Operating Humidity	10% to 85%, Non-condensing
Storage Humidity	5% to 90%, Non-condensing

Appendix K: Warranty Information

BE SURE TO HAVE YOUR PROOF OF PURCHASE AND A BARCODE FROM THE PRODUCT'S PACKAGING ON HAND WHEN CALLING. RETURN REQUESTS CANNOT BE PROCESSED WITHOUT PROOF OF PURCHASE.

IN NO EVENT SHALL LINKSYS'S LIABILITY EXCEED THE PRICE PAID FOR THE PRODUCT FROM DIRECT, INDIRECT, SPECIAL, INCIDENTAL, OR CONSEQUENTIAL DAMAGES RESULTING FROM THE USE OF THE PRODUCT, ITS ACCOMPANYING SOFTWARE, OR ITS DOCUMENTATION. LINKSYS DOES NOT OFFER REFUNDS FOR ANY PRODUCT.

LINKSYS OFFERS CROSS SHIPMENTS, A FASTER PROCESS FOR PROCESSING AND RECEIVING YOUR REPLACEMENT. LINKSYS PAYS FOR UPS GROUND ONLY. ALL CUSTOMERS LOCATED OUTSIDE OF THE UNITED STATES OF AMERICA AND CANADA SHALL BE HELD RESPONSIBLE FOR SHIPPING AND HANDLING CHARGES. PLEASE CALL LINKSYS FOR MORE DETAILS.

Appendix L: Contact Information

For help with the installation or operation of your Instant Broadband EtherFast Cable/DSL Router, contact Linksys Technical Support at one of the phone numbers or Internet addresses below.

Sales Information	800-546-5797 (1-800-LINKSYS)
Technical Support	800-326-7114
RMA Issues	949-271-5461
Fax	949-265-6655
Email	support@linksys.com
Web site	http://www.linksys.com
FTP site	ftp://ftp.linksys.com



www.linksys.com

© Copyright 2002 Linksys, All Rights Reserved.

Free Manuals Download Website

<http://myh66.com>

<http://usermanuals.us>

<http://www.somanuals.com>

<http://www.4manuals.cc>

<http://www.manual-lib.com>

<http://www.404manual.com>

<http://www.luxmanual.com>

<http://aubethermostatmanual.com>

Golf course search by state

<http://golfingnear.com>

Email search by domain

<http://emailbydomain.com>

Auto manuals search

<http://auto.somanuals.com>

TV manuals search

<http://tv.somanuals.com>