

# LINKSYS®

A Division of Cisco Systems, Inc.



2.4GHz  
802.11g

## Wireless-G

Broadband Router  
with 2 Phone Ports

## User Guide



Model No. **WRT54GP2A-AT**



## Copyright and Trademarks

Specifications are subject to change without notice. Linksys is a registered trademark or trademark of Cisco Systems, Inc. and/or its affiliates in the U.S. and certain other countries. Copyright © 2004 Cisco Systems, Inc. All rights reserved. Other brands and product names are trademarks or registered trademarks of their respective holders.

**WARNING:** This product contains chemicals, including lead, known to the State of California to cause cancer, and birth defects or other reproductive harm. *Wash hands after handling.*

## How to Use this Guide

Your guide to the Wireless-G Broadband Router with 2 Phone Ports has been designed to make understanding networking with the Router easier than ever. Look for the following items when reading this User Guide:



This checkmark means there is a note of interest and is something you should pay special attention to while using the Router.



This exclamation point means there is a caution or warning and is something that could damage your property or the Router.



This question mark provides you with a reminder about something you might need to do while using the Router.

In addition to these symbols, there are definitions for technical terms that are presented like this:

*word: definition.*

Also, each figure (diagram, screenshot, or other image) is provided with a figure number and description, like this:

**Figure 0-1: Sample Figure Description**

Figure numbers and descriptions can also be found in the “List of Figures” section.

# Table of Contents

Chapter 1: Introduction	1
Welcome	1
What's in this Guide?	2
Chapter 2: Planning Your Wireless Network	4
Network Topology	4
Ad-Hoc versus Infrastructure Mode	4
Network Layout	5
Chapter 3: Getting to Know the Router	6
The Back Panel	6
The Front Panel	7
Chapter 4: Connecting the Router	8
Overview	8
Connecting the Router to Your Broadband Modem	8
Connecting One Router to Another	9
Chapter 5: Configuring the Router	11
Overview	11
How to Access the Web-based Utility	13
The Setup Tab - Basic Setup	13
The Setup Tab - DDNS	18
The Setup Tab - MAC Address Clone	19
The Wireless Tab - Basic Wireless Settings	20
The Wireless Tab - Wireless Security	21
The Wireless Tab - Wireless MAC Filter	23
The Wireless Tab - Advanced Wireless Settings	24
The Security Tab - Firewall	25
The Security Tab - VPN	26
The Access Restrictions Tab - Internet Access	27
The Applications & Gaming Tab - Port Range Forward	29
The Applications & Gaming Tab - Port Trigger	30
The Applications & Gaming Tab - UPnP Forward	31
The Applications & Gaming Tab - DMZ	33
The Administration Tab - Management	34

The Administration Tab - Log	36
The Administration Tab - Diagnostics	37
The Administration Tab - Factory Defaults	38
The Administration Tab - Backup and Restore	39
The Administration Tab - Reboot	39
The Status Tab - Router	40
The Status Tab - Local Network	41
The Status Tab - Wireless	42
The Status Tab - Voice	43
<b>Chapter 6: Signing up for AT&amp;T CallVantage<sup>sm</sup> Service</b>	<b>44</b>
Overview	44
Instructions	44
<b>Appendix A: Troubleshooting</b>	<b>45</b>
Common Problems and Solutions	45
Frequently Asked Questions	55
<b>Appendix B: Wireless Security</b>	<b>59</b>
Security Precautions	59
Security Threats Facing Wireless Networks	59
<b>Appendix C: Windows Help</b>	<b>62</b>
<b>Appendix D: Finding the MAC Address and IP Address for Your</b>	
Ethernet Adapter	63
Windows 98 or Me Instructions	63
Windows 2000 or XP Instructions	63
For the Router's Web-based Utility	64
<b>Appendix E: Glossary</b>	<b>65</b>
<b>Appendix F: Specifications</b>	<b>72</b>
<b>Appendix G: Warranty Information</b>	<b>74</b>
<b>Appendix H: Regulatory Information</b>	<b>75</b>
<b>Appendix I: Contact Information</b>	<b>77</b>
AT&T	77
Linksys	77

# List of Figures

Figure 3-1: Back Panel	6
Figure 3-2: Front Panel	7
Figure 4-1: Connect the Broadband Modem	8
Figure 4-2: Connect a Telephone	8
Figure 4-3: Connect a PC	8
Figure 4-4: Connect the Power	8
Figure 4-5: Router Connected to Another Router	9
Figure 4-6: Connect the Broadband Modem	10
Figure 4-7: Connect a Telephone	10
Figure 4-8: Connect the Other Router	10
Figure 4-9: Connect the Power	10
Figure 5-1: Router's IP Address	13
Figure 5-2: Router Login	13
Figure 5-3: Setup Tab - Basic Setup - Automatic Configuration (DHCP)	13
Figure 5-4: Static IP	14
Figure 5-5: PPPoE	14
Figure 5-6: PPTP	15
Figure 5-7: Setup Tab - DDNS (DynDNS.org)	18
Figure 5-8: Setup Tab - DDNS (TZO.com)	18
Figure 5-9: Setup Tab - MAC Address Clone	19
Figure 5-10: Wireless Tab - Basic Wireless Settings	20
Figure 5-11: Wireless Tab - Wireless Security (WPA Pre-Shared Key)	21
Figure 5-12: Wireless Tab - Wireless Security (WPA RADIUS)	21
Figure 5-13: Wireless Tab - Wireless Security (RADIUS)	22
Figure 5-14: Wireless Tab - Wireless Security (WPA RADIUS)	22
Figure 5-15: Wireless Tab - Wireless MAC Filter	23
Figure 5-16: MAC Address Filter List	23
Figure 5-17: Wireless Client MAC List	23

Figure 5-18: Wireless Tab - Advanced Wireless Settings	24
Figure 5-19: Security Tab - Firewall	25
Figure 5-20: Security Tab - VPN	26
Figure 5-21: Access Restrictions Tab - Internet Access	27
Figure 5-22: Internet Policy Summary	27
Figure 5-23: List of PCs	28
Figure 5-24: Applications & Gaming Tab - Port Range Forward	29
Figure 5-25: Applications & Gaming Tab - Port Trigger	30
Figure 5-26: Applications & Gaming Tab - UPnP Forward	31
Figure 5-27: Applications & Gaming Tab - DMZ	33
Figure 5-28: Administration Tab - Management	34
Figure 5-29: Administration Tab - Log	36
Figure 5-30: Administration Tab - Diagnostics	37
Figure 5-31: Ping Test	37
Figure 5-32: Traceroute Test	37
Figure 5-33: Administration Tab - Factory Defaults	38
Figure 5-34: Administration Tab - Backup and Restore	39
Figure 5-35: Administration Tab - Reboot	39
Figure 5-36: Status Tab - Router	40
Figure 5-37: Status Tab - Local Network	41
Figure 5-38: DHCP Clients Table	41
Figure 5-39: Status Tab - Wireless	42
Figure 5-40: Wireless Client MAC List	42
Figure 5-41: Status Tab - Voice	43
Figure 6-1: Website for AT&T CallVantage Service	44
Figure D-1: IP Configuration Screen	63
Figure D-2: MAC Address/Adapter Address	63
Figure D-3: MAC Address/Physical Address	64
Figure D-4: Access Restrictions - MAC and IP Addresses	64
Figure D-5: MAC Address Clone	64

# Chapter 1: Introduction

## Welcome

Thank you for choosing the Wireless-G Broadband Router with 2 Phone Ports. This Router can direct and control communications for your wired and wireless networks, sharing Internet access, files and fun, easily and securely. Plus, after you have set up your Internet phone service, make phone or fax calls using your Internet connection.

How does the Router do all of this? A router is a device that allows access to an Internet connection over a network. With the Wireless-G Broadband Router, this access can be shared over the four switched ports or via the wireless broadcast at either up to 11Mbps for Wireless-B or up to 54Mbps for Wireless-G. In addition, the WPA standard provides greater security opportunities while the whole network is protected through NAT technology. Full configurability, including these security features, are accessed through the easy-to-use, web-based utility.

But what does all of this mean?

Networks are useful tools for sharing Internet access and computer resources. Multiple computers can share Internet access, so you don't need more than one high-speed Internet connection. After you set up your Internet phone service, you can also make Internet phone or fax calls, even while you're surfing the Internet. Plus, you can access one printer from different computers and access data located on another computer's hard drive. Networks are even used for playing multiplayer video games. All the while, the Router protects your networks from unauthorized and unwelcome users. So, networks not only are useful in homes and offices, but also can be fun.

PCs on a wired network create a LAN, or Local Area Network. They are connected with Ethernet cables, which is why the network is called "wired".

PCs equipped with wireless cards or adapters can communicate without cumbersome cables. By sharing the same wireless settings, within their transmission radius, they form a wireless network, which is sometimes called a Wireless Local Area Network (WLAN). The Router bridges wireless networks of both 802.11b and 802.11g standards and wired networks, allowing them to communicate with each other.

To create your network, install and set up the Router. To guide you through the process, Linksys strongly recommends that you run the Setup Wizard on the Setup CD-ROM. If you prefer to manually set up the Router, use the instructions in the Quick Installation or this User Guide to help you. These instructions should be all you need to get the most out of the Wireless-G Broadband Router.



**NOTE:** If you want to sign up for Internet phone service or activate your account, visit <http://www.att.com/linksys> after you have installed and configured the Router. Refer to "Chapter 6: Signing up for AT&T CallVantage<sup>SM</sup> Service" for more information.

**mbps:** one million bits per second; a unit of measurement for data transmission

**nat (network address translation):** NAT technology translated IP addresses of a local area network to a different IP address for the Internet

**wpa (wi-fi protected access):** a wireless security protocol using TKIP (Temporal Key Integrity Protocol) encryption, which can be used in conjunction with a RADIUS server

**browser:** an application program that provides a way to look at and interact with all the information on the World Wide Web

**lan (local area network):** the computers and networking products that make up the network in your home or office

**ethernet:** an IEEE standard network protocol that specifies how data is placed on and retrieved from a common transmission medium

**802.11b:** an IEEE wireless networking standard that specifies a maximum data transfer rate of 11Mbps and an operating frequency of 2.4GHz

**802.11g:** an IEEE wireless networking standard that specifies a maximum data transfer rate of 54Mbps, an operating frequency of 2.4GHz, and backward compatibility with 802.11b devices

## What's in this Guide?

This user guide covers the basic steps for setting up a network with a router. After going through "Chapter 3: Getting to Know the Router," most users will only need to use the following chapters:

- **Chapter 4: Connecting the Router**  
This chapter instructs you on how to connect the Router to your cable or DSL modem and PCs. After you create your network, then you will connect the telephones (or fax machines) to AT&T CallVantage<sup>SM</sup> Service via the Router.
- **Chapter 5: Configuring the Router**  
This chapter explains how to configure the Router using your web browser and the Router's Web-based Utility. You will configure the Router using the settings provided by your ISP.
- **Chapter 6: Signing up for AT&T CallVantage<sup>SM</sup> Service**  
When you are ready to sign up for or activate your AT&T CallVantage Service account, refer to the instructions in this chapter.

When you're finished with the basic steps, then you are ready to connect to the Internet.

You also have other chapter available for reference:

- **Chapter 1: Introduction**  
This chapter describes the Router's applications and this User Guide.
- **Chapter 2: Planning Your Wireless Network**  
This chapter describes the basics of wireless networking.
- **Appendix A: Troubleshooting**  
This appendix describes some possible problems and solutions, as well as frequently asked questions, regarding installation and use of the Router.
- **Appendix B: Wireless Security**  
This appendix explains the risks of wireless networking and some solutions to reduce the risks.
- **Appendix C: Windows Help**  
This appendix describes how you can use Windows Help for instructions about networking, such as installing the TCP/IP protocol.



## Wireless-G Broadband Router with 2 Phone Ports

- **Appendix D: Finding the MAC Address and IP Address for Your Ethernet Adapter**  
This appendix instructs you on how to find the MAC address or Ethernet address of your PC's Ethernet network adapter.
- **Appendix E: Glossary**  
This appendix gives a brief glossary of terms frequently used in networking.
- **Appendix F: Specifications**  
This appendix provides the technical specifications for the Router.
- **Appendix G: Warranty Information**  
This appendix supplies the warranty information for the Router.
- **Appendix H: Regulatory Information**  
This appendix supplies the regulatory information regarding the Router.
- **Appendix I: Contact Information**  
This appendix provides contact information for a variety of Linksys resources, including Technical Support.

# Chapter 2: Planning Your Wireless Network

## Network Topology

A Wireless Local Area Network (WLAN) is exactly like a regular Local Area Network (LAN), except that each computer in the WLAN uses a wireless device to connect to the network. Computers in a WLAN share the same frequency channel and SSID, which is an identification name shared by the wireless devices belonging to the same wireless network.

## Ad-Hoc versus Infrastructure Mode

Unlike wired networks, wireless networks have two different modes in which they may be set up: infrastructure and ad-hoc. An infrastructure configuration is a WLAN and wired LAN communicating to each other through an access point. An ad-hoc configuration is wireless-equipped computers communicating directly with each other. Choosing between these two modes depends on whether or not the wireless network needs to share data or peripherals with a wired network or not.

If the computers on the wireless network need to be accessible by a wired network or need to share a peripheral, such as a printer, with the wired network computers, the wireless network should be set up in Infrastructure mode. The basis of Infrastructure mode centers around an access point or wireless router, such as the Wireless-G Broadband Router with 2 Phone Ports, which serves as the main point of communications in a wireless network. The Router transmits data to PCs equipped with wireless network adapters, which can roam within a certain radial range of the Router. You can arrange the Router and multiple access points to work in succession to extend the roaming range, and you can set up your wireless network to communicate with your Ethernet hardware as well.

If the wireless network is relatively small and needs to share resources only with the other computers on the wireless network, then the Ad-Hoc mode can be used. Ad-Hoc mode allows computers equipped with wireless transmitters and receivers to communicate directly with each other, eliminating the need for a wireless router or access point. The drawback of this mode is that in Ad-Hoc mode, wireless-equipped computers are not able to communicate with computers on a wired network. And, of course, communication between the wireless-equipped computers is limited by the distance and interference directly between them.

**network:** a series of computers or devices connected for the purpose of data sharing, storage, and/or transmission between users

**ssid:** your wireless network's name

**ad-hoc:** a group of wireless devices communicating directly to each other (peer-to-peer) without the use of an access point

**infrastructure:** a wireless network that is bridged to a wired network via an access point

**adapter:** a device that adds network functionality to your PC

**ethernet:** IEEE standard network protocol that specifies how data is placed on and retrieved from a common transmission medium

**access point:** a device that allows wireless-equipped computers and other devices to communicate with a wired network. Also used to expand the range of a wireless network

## Network Layout

The Router has been specifically designed for use with both your 802.11b and 802.11g products. It is compatible with all 802.11b and 802.11g adapters, such as the Notebook Adapters (WPC54G, WPC11) for your laptop computers, PCI Adapter (WMP54G, WMP11) for your desktop PC, and USB Adapter (WUSB54G, WUSB11) when you want to enjoy USB connectivity. The Router will also communicate with the Wireless PrintServer (WPS54GU2, WPS54G, WPS11) and Wireless Ethernet Bridges (WET54G, WET11).

When you wish to connect your wireless network with your wired network, you can use the Router's four Ethernet network ports. To add more ports, any of the Router's Ethernet network ports can be connected to any of Linksys's switches (such as the EZXS55W or EZXS88W).

With these, and many other, Linksys products, your networking options are limitless. Go to the Linksys website at [www.linksys.com](http://www.linksys.com) for more information about products that work with the Wireless-G Broadband Router with 2 Phone Ports.

# Chapter 3: Getting to Know the Router

## The Back Panel

The Router's ports and the Reset button are located on the back panel of the Router.



Figure 3-1: Back Panel

- Internet** This **Internet** port connects to your cable or DSL modem.
- Phone1** For your primary Internet phone line, the **Phone1** port allows you to connect the Router to your telephone (or fax machine) using an RJ-11 telephone cable (not included).
- Phone2** If you have a second Internet phone line, the **Phone2** port allows you to connect the Router to your second telephone (or fax machine) using an RJ-11 telephone cable (not included).
- Ethernet 1-4** These four **Ethernet** ports connect to network devices, such as PCs, print servers, or additional switches.
- Reset Button** There are two ways to reset the Router to its factory default settings. Either press the **Reset** button for approximately five seconds, or restore the defaults from the Administration tab - Factory Defaults of the Router's Web-based Utility.
- Power** The **Power** port is where you will connect the power adapter.



**IMPORTANT:** If you reset the Router, all of your settings, including Internet connection, Internet phone service, and security settings, will be deleted and replaced with the factory defaults. Do not reset the Router if you want to retain these settings.

(If you have an active Internet phone service account and reset the Router, then the Router will automatically download its Internet phone service settings once it is connected to the Internet again.)

## The Front Panel

The Router's LEDs, which inform you about network activities, are located on the front panel.



Figure 3-2: Front Panel

- Power** Green. The **Power** LED lights up when the Router is powered on. If the LED is flashing, the Router is booting up or running a system self-test.
- WLAN** Green. The **WLAN** LED lights up whenever there is a successful wireless connection. If the LED is flashing, the Router is actively sending or receiving data over the wireless network.
- Ethernet 1-4** Green. The **Ethernet** LED serves two purposes. If the LED is solidly lit, the Router is connected to a device through the corresponding port (Ethernet 1, 2, 3, or 4). If the LED is flashing, the Router is sending or receiving data over that port.
- Phone 1-2** Green. The **Phone** LED is solidly lit when a telephone or fax machine has a registered connection to AT&T through the corresponding port (Phone 1 or Phone 2). (The connection is registered if your Internet phone service account is active.) This LED is not lit when there is no registered connection. It flashes when the phone is being used or an incoming call has been detected.
- Internet** Green. The **Internet** LED lights up when the Router is connected to your cable or DSL modem. If the LED is flashing, the Router is sending or receiving data over the Internet port.

Proceed to "Chapter 4: Connecting the Router."

# Chapter 4: Connecting the Router

## Overview

This chapter includes two sets of instructions. If the Wireless-G Broadband Router with 2 Phone Ports will be the only router in your network, follow the instructions in "Connecting the Router to Your Broadband Modem." If you already have a router in your network and want to add the Wireless-G Broadband Router with 2 Phone Ports, follow the instructions in "Connecting One Router to Another."

## Connecting the Router to Your Broadband Modem

1. Make sure that all of your hardware is powered off, including the Router, PCs, and broadband modem.
2. Connect your broadband modem's Ethernet cable to the Router's Internet port.
3. Plug a standard telephone into the Router's Phone1 port.



**IMPORTANT:** Do not connect the Phone port to a telephone wall jack. Make sure you only connect a telephone or fax machine to the Phone port. Otherwise, the Router or the telephone wiring in your home or office may be damaged.



**NOTE:** Make sure your telephone is set to its tone setting (not pulse).

4. Connect one end of an Ethernet network cable to one of the numbered ports on the back of the Router. Connect the other end to an Ethernet port on a network device, e.g., a PC, print server, or switch.

Repeat this step to connect more PCs or other network devices to the Router.

5. Power on the broadband modem.
6. Connect the included power adapter to the Router's Power port, and then plug the power adapter into an electrical outlet. The Power LED on the front panel will light up as soon as the Router powers on.
7. Power on your PC(s).

Proceed to "Chapter 5: Configuring the Router."



Figure 4-1: Connect the Broadband Modem



Figure 4-2: Connect a Telephone



Figure 4-3: Connect a PC



Figure 4-4: Connect the Power

## Connecting One Router to Another

If you already have a router (for example, a wireless router) and want to add the Wireless-G Broadband Router with 2 Phone Ports, then you should use the Wireless-G Broadband Router with 2 Phone Ports as your primary router so the Internet phone calls will be routed properly. For example, the following connection diagram shows the Wireless-G Broadband Router with 2 Phone Ports connected to a wired router, phone, and desktop PCs.

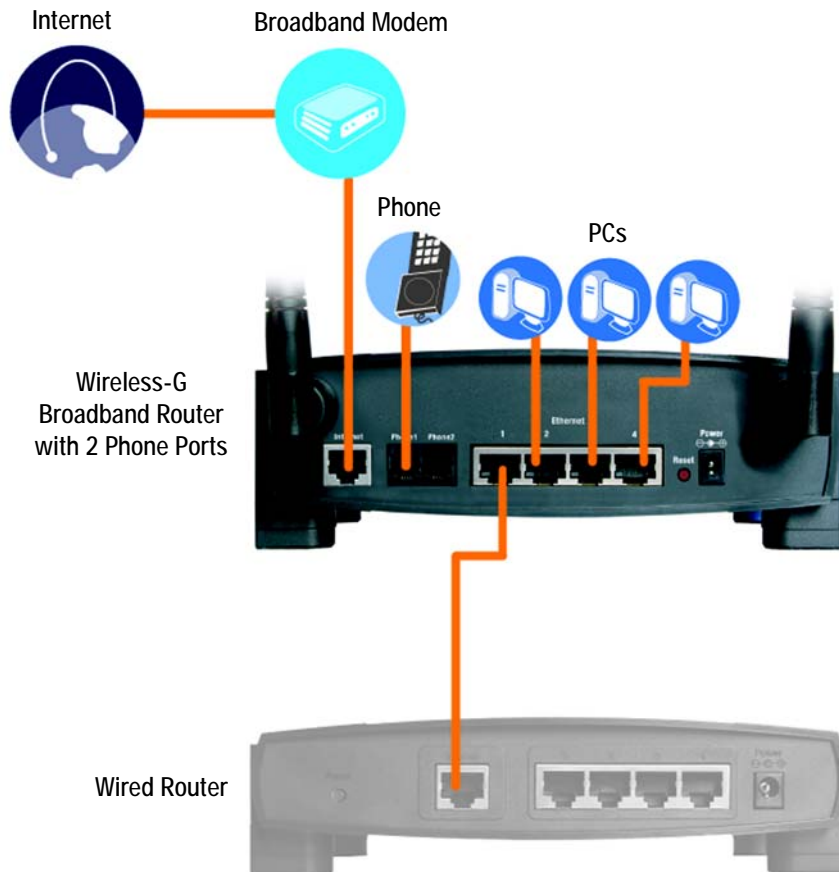

Figure 4-5: Router Connected to Another Router

## Wireless-G Broadband Router with 2 Phone Ports

To connect the Wireless-G Broadband Router with 2 Phone Ports to another router, follow these instructions:

1. Make sure that all of your hardware is powered off, including both routers, PCs, and broadband modem.
2. Disconnect your existing router from the broadband modem, PCs, and other network devices.
3. Connect your broadband modem's Ethernet cable to the Internet port on the back of the Wireless-G Broadband Router with 2 Phone Ports.
4. Plug a standard telephone into the Router's Phone1 port.



**IMPORTANT:** Do not connect the Phone port to a telephone wall jack. Make sure you only connect a telephone or fax machine to the Phone port. Otherwise, the Router or the telephone wiring in your home or office may be damaged.



**NOTE:** Make sure your telephone is set to its tone setting (not pulse).

5. Connect one end of an Ethernet network cable to one of the numbered ports on the back of the Router. Connect the other end to the Internet port on the back of the other router.

Repeat this step to connect PCs or other network devices to the Router.

6. Power on the cable or DSL modem.
7. Connect the included power adapter to the Router's Power port, and then plug the power adapter into an electrical outlet. The Power LED on the front panel will light up as soon as the Router powers on.
8. Power on the other router.
9. Power on your PC(s).

**Proceed to "Chapter 5: Configuring the Router."**



Figure 4-6: Connect the Broadband Modem



Figure 4-7: Connect a Telephone



Figure 4-8: Connect the Other Router



Figure 4-9: Connect the Power



# Chapter 5: Configuring the Router

## Overview

Linksys recommends using the Setup CD-ROM for first-time installation of the Router. If you do not wish to run the Setup Wizard on the Setup CD-ROM, then you can use the Web-based Utility to configure the Router. For advanced users, you may configure the Router's advanced settings through the Web-based Utility.



**NOTE:** If you want to sign up for Internet phone service or activate your account, visit <http://www.att.com/linksys> after you have installed and configured the Router. Refer to "Chapter 6: Signing up for AT&T CallVantage<sup>SM</sup> Service" for more information.

This chapter will describe each web page on the Utility and each page's key functions. The Utility can be accessed via your web browser through use of a computer connected to the Router. For a basic network setup, most users only have to use the following screens of the Utility:

- **Basic Setup.** On the *Basic Setup* screen, enter the Internet connection settings provided by your ISP. If you do not have this information, you can call your ISP to request the settings. Once you have the setup information for your specific type of Internet connection, then you can configure the Router.
- **Management.** Click the **Administration** tab and then the **Management** tab. The Router's default password is **admin**. To secure the Router, change the Password from its default.

There are six main tabs: Setup, Security, Access Restrictions, Applications & Gaming, Administration, and Status. Additional tabs will be available after you click one of the main tabs.

## Setup

- **Basic Setup.** Enter the Internet connection and network settings on this screen.
- **DDNS.** Enable the Router's Dynamic Domain Name System (DDNS) feature on this screen.
- **MAC Address Clone.** If you need to clone a MAC address onto the Router, use this screen.

## Wireless

- **Basic Wireless Settings.** Enter the basic settings for your wireless network on this screen.
- **Wireless Security.** Enable and configure the security settings for your wireless network.

## Broadband Router with 2 Phone Ports

- **Wireless MAC Filter.** Wireless access can be filtered by using the MAC addresses of the wireless devices transmitting within your network's radius.
- **Advanced Wireless Settings.** For advanced users, you can alter data transmission settings on this screen.

## Security

- **Firewall.** On this screen, you can configure a variety of filters to enhance the security of your network.
- **VPN.** To enable or disable IPSec, PPTP, and/or L2TP Passthrough, use this screen.

## Access Restrictions

- **Internet Access.** This screen allows you to permit or block specific kinds of Internet usage and traffic.

## Applications & Gaming

- **Port Range Forward.** Set up public services or other specialized Internet applications on your network.
- **Port Trigger.** To set up triggered ranges and forwarded ranges for Internet applications, click this tab.
- **UPnP Forward.** Use this screen to alter UPnP forwarding settings.
- **DMZ.** Click this tab to allow one local user to be exposed to the Internet for use of special-purpose services.

## Administration

- **Management.** On this screen, alter the Router's password and access privileges, as well as the SNMP and UPnP settings.
- **Log.** If you want to view or save activity logs, click this tab.
- **Diagnostics.** Use this screen to check the connections of your network components.
- **Factory Defaults.** If you want to restore the Router's factory defaults, then use this screen.
- **Backup and Restore.** You can back up and restore the Router's configuration if necessary.
- **Reboot.** Use this screen to remotely reboot the Router from your computer.

## Status

- Router. This screen provides status information about the Router.
- Local Network. This provides status information about the local network.
- Wireless. The settings for your wireless network are displayed on this screen.
- Voice. This screen provides status information about the Internet phone lines.

## How to Access the Web-based Utility

To access the Web-based Utility of the Router, launch Internet Explorer or Netscape Navigator, and enter the Router's default IP address, **192.168.15.1**, in the *Address* field. Press the **Enter** key.

A screen will appear asking you for your User Name and Password. Leave the *User Name* field blank, and enter **admin** in the *Password* field. Then click the **OK** button.

Make the necessary changes through the Utility. When you have finished making changes to a screen, click the **Save Settings** button to save the changes, or click the **Cancel Changes** button to undo your changes. For help information on a tab, click **Help**.

## The Setup Tab - Basic Setup

The *Basic Setup* screen is the first screen you see when you access the Web-based Utility.

### Internet Setup

The Internet Setup section configures the Router for your Internet connection type. This information can be obtained from your ISP.

### Internet Connection Type

The Router supports four connection types: Automatic Configuration (DHCP), Static IP, PPPoE, and PPTP. Each *Basic Setup* screen and available features will differ depending on what kind of connection type you select.

#### Automatic Configuration (DHCP)

By default, the Router's Internet Connection Type is set to **Automatic Configuration (DHCP)**, and it should be used only if your ISP supports DHCP or you are connecting through a dynamic IP address.



Figure 5-1: Router's IP Address



Figure 5-2: Router Login

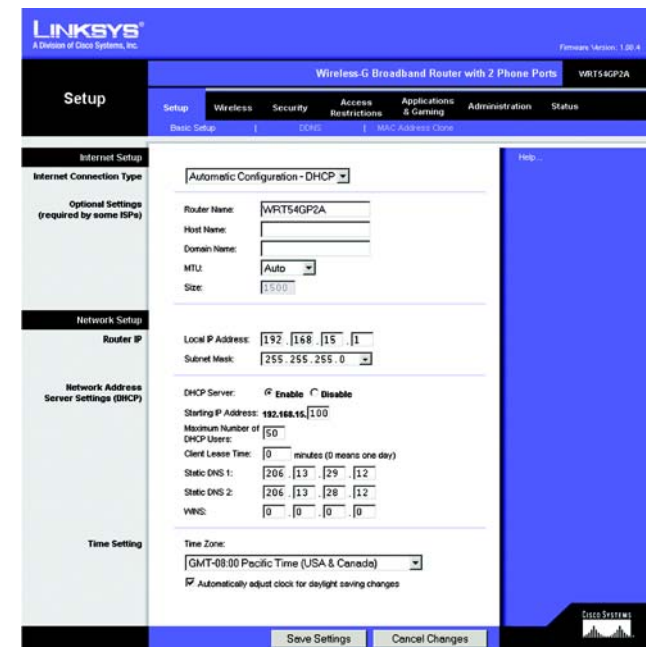

Figure 5-3: Setup Tab - Basic Setup - Automatic Configuration (DHCP)

## Static IP

If you are required to use a permanent IP address, then select **Static IP**.

**Internet IP Address.** This is the IP address that the Router has, when seen from the Internet. Your ISP will provide you with the IP Address you need to specify here.

**Subnet Mask.** This is the Router's Subnet Mask, as seen by external users on the Internet (including your ISP). Your ISP will provide you with the Subnet Mask.

**Default Gateway.** Your ISP will provide you with the Default Gateway Address.

**Static DNS 1-2.** Your ISP will provide you with at least one DNS (Domain Name System) Server IP Address.

## PPPoE

Some DSL-based ISPs use PPPoE (Point-to-Point Protocol over Ethernet) to establish Internet connections for end-users. If you use a DSL line, check with your ISP to see if they use PPPoE. If they do, you will have to enable it.

**User Name and Password.** Enter the User Name and Password provided by your ISP.

**Connect on Demand and Max Idle Time.** You can configure the Router to cut the Internet connection after it has been inactive for a specific period of time (Max Idle Time). If your Internet connection has been terminated due to inactivity, Connect on Demand enables the Router to automatically re-establish your connection as soon as you attempt to access the Internet again. If you wish to activate Connect on Demand, click the radio button. If you want your Internet connection to remain on at all times, enter **0** in the *Max Idle Time* field. Otherwise, enter the number of minutes you want to have elapsed before your Internet access disconnects.

**Keep Alive and Redial Period.** This option keeps your Internet access connected indefinitely, even when it sits idle. If you select this option, the Router will periodically check your Internet connection. If the connection is down, then the Router will automatically re-establish the connection. To use this option, click the radio button next to *Keep Alive*. The default Redial Period is 30 seconds.

When you are finished, click the **Save Settings** button. Then click the **Status** tab, and click the **Connect** button to start the connection.

Figure 5-4: Static IP

*static ip address:* a fixed address assigned to a computer or device connected to a network.

*subnet mask:* an address code that determines the size of the network

*default gateway:* a device that forwards Internet traffic from your local area network

Figure 5-5: PPPoE

*pppoe:* a type of broadband connection that provides authentication (username and password) in addition to data transport



**NOTE:** For DSL users, if you need to enable PPPoE support, remember to remove any PPPoE applications that are installed on your PCs.

## PPTP

Point-to-Point Tunneling Protocol (PPTP) is a service that applies to connections in Europe and Israel only.

**Internet IP Address.** This is the IP address that the Router has, when seen from the Internet. Your ISP will provide you with the IP Address you need to specify here.

**Subnet Mask.** This is the Router's Subnet Mask, as seen by external users on the Internet (including your ISP). Your ISP will provide you with the Subnet Mask.

**Gateway.** Your ISP will provide you with the Default Gateway Address.

**User Name and Password.** Enter the User Name and Password provided by your ISP.

**Connect on Demand and Max Idle Time.** You can configure the Router to cut the Internet connection after it has been inactive for a specific period of time (Max Idle Time). If your Internet connection has been terminated due to inactivity, Connect on Demand enables the Router to automatically re-establish your connection as soon as you attempt to access the Internet again. If you wish to activate Connect on Demand, click the radio button. If you want your Internet connection to remain on at all times, enter 0 in the *Max Idle Time* field. Otherwise, enter the number of minutes you want to have elapsed before your Internet access disconnects.

**Keep Alive and Redial Period.** This option keeps your Internet access connected indefinitely, even when it sits idle. If you select this option, the Router will periodically check your Internet connection. If the connection is down, then the Router will automatically re-establish the connection. To use this option, click the radio button next to *Keep Alive*. The default Redial Period is 30 seconds.

When you are finished, click the **Save Settings** button. Then click the **Status** tab, and click the **Connect** button to start the connection.

## Optional Settings

Some of these settings may be required by your ISP. Verify with your ISP before making any changes.

**Router Name.** Enter a name for this Router.

**Host Name and Domain Name.** These fields allow you to supply a host and domain name for the Router. Some ISPs require these names as identification. You may have to check with your ISP to see if your broadband Internet service has been configured with a host and domain name. In most cases, leaving these fields blank will work.

**MTU.** The MTU (Maximum Transmission Unit) setting specifies the largest packet size permitted for network transmission. The default is **Auto**. If you want to manually enter a value, select **Manual** and enter the value

The screenshot shows a configuration window titled 'PPTP'. It contains the following fields and options:

- Internet IP Address:** Four input boxes containing '0', '0', '0', and '0'.
- Subnet Mask:** Four input boxes containing '255', '255', '255', and '0'.
- Gateway:** Four input boxes containing '0', '0', '0', and '0'.
- User Name:** A text input field.
- Password:** A text input field.
- Connect on Demand:** A radio button (unselected) next to 'Max Idle Time' with a value of '5' and the unit 'Min.'.
- Keep Alive:** A radio button (selected) next to 'Redial Period' with a value of '30' and the unit 'Sec.'.

Figure 5-6: PPTP

desired. It is recommended that you leave this value in the 1200 to 1500 range. For most DSL users, it is recommended to use the value 1492. By default, MTU is set at 1500 when disabled.

### Network Setup

The Network Setup section allows you to change the Router's local network settings.

#### Router IP

The values for the Router's Local IP Address and Subnet Mask are shown here. In most cases, keeping the default values will work.

**Local IP Address.** The default value is **192.168.15.1**.

**Subnet Mask.** The default value is **255.255.255.0**.

#### Network Address Server Settings (DHCP)

These settings allow you to configure the Router's Dynamic Host Configuration Protocol (DHCP) server function. The Router can be used as a DHCP server for your network. A DHCP server automatically assigns an IP address to each computer on your network. Unless you already have one, it is highly recommended that you leave the Router enabled as a DHCP server.

**DHCP Server.** DHCP is enabled by factory default. If you already have a DHCP server on your network, set the Router's DHCP option to **Disable**. If you disable DHCP, remember to assign a static IP address to the Router.

**Starting IP Address.** Enter a value for the DHCP server to start with when issuing IP addresses. Because the default IP address for the Router is 192.168.15.1, the Start IP Address must be 192.168.15. 2 or greater, but smaller than 192.168.15.254. The default Start IP Address is **192.168.15.100**.

**Maximum Number of DHCP Users (Optional).** Enter the maximum number of PCs that you want the DHCP server to assign IP addresses to. This number cannot be greater than 253. The default is **50**.

**Client Lease Time.** The Client Lease Time is the amount of time a network user will be allowed connection to the Router with their current dynamic IP address. Enter the amount of time, in minutes, that the user will be "leased" this dynamic IP address. After the dynamic IP address has expired, the user will be automatically assigned a new dynamic IP address. The default is **0** minutes, which means one day.

**Static DNS 1-2.** The Domain Name System (DNS) is how the Internet translates domain or website names into Internet addresses or URLs. Your ISP will provide you with at least one DNS Server IP Address. You can enter up to two DNS Server IP Addresses here. The Router will use these for quicker access to functioning DNS servers.

*dynamic ip address: a temporary IP address assigned by a DHCP server*

## Broadband Router with 2 Phone Ports

**WINS.** The Windows Internet Naming Service (WINS) converts NetBIOS names to IP addresses. If you use a WINS server, enter that server's IP address here. Otherwise, leave this field blank.

### Time Setting

**Time Zone.** Select the time zone in which your network functions from this pull-down menu. If you want the Router to automatically adjust its clock for daylight savings, click the checkbox next to *Automatically adjust clock for daylight saving changes*.

When you have finished making changes to this screen, click the **Save Settings** button to save the changes, or click the **Cancel Changes** button to undo your changes. For help information, click **Help**.



**NOTE:** To test your settings, connect to the Internet now.

## The Setup Tab - DDNS

The Router offers a Dynamic Domain Name System (DDNS) feature. DDNS lets you assign a fixed host and domain name to a dynamic Internet IP address. It is useful when you are hosting your own website, FTP server, or other server behind the Router.

Before you can use this feature, you need to sign up for DDNS service at one of two DDNS service providers, DynDNS.org or TZO.com. If you do not want to use this feature, keep the default setting, **Disable**.

### DDNS

**DDNS Service.** If your DDNS service is provided by DynDNS.org, then select **DynDNS.org** from the drop-down menu. If your DDNS service is provided by TZO, then select **TZO.com**. The features available on the *DDNS* screen will vary, depending on which DDNS service provider you use.

#### DynDNS.org

**User Name, Password, and Host Name.** Enter the User Name, Password, and Host Name of the account you set up with DynDNS.org.

**Internet IP Address.** The Router's current Internet IP Address is displayed here. Because it is dynamic, it will change.

**Status.** The status of the DDNS service connection is displayed here.

When you have finished making changes to this screen, click the **Save Settings** button to save the changes, or click the **Cancel Changes** button to undo your changes. For help information, click **Help**.

#### TZO.com

**E-mail Address, Password, and Domain Name.** Enter the Email Address, Password, and Domain Name of the service you set up with TZO.

**Internet IP Address.** The Router's current Internet IP Address is displayed here. Because it is dynamic, this will change.

**Status.** The status of the DDNS service connection is displayed here.

When you have finished making changes to this screen, click the **Save Settings** button to save the changes, or click the **Cancel Changes** button to undo your changes. For help information, click **Help**.

*ddns: allows the hosting of a website, FTP server, or e-mail server with a fixed domain name (e.g., www.xyz.com) and a dynamic IP address*

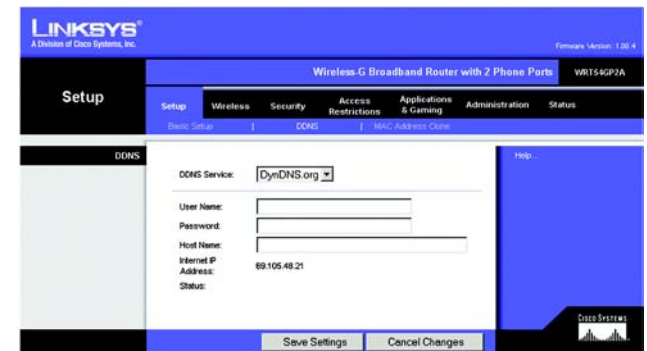

Figure 5-7: Setup Tab - DDNS (DynDNS.org)



Figure 5-8: Setup Tab - DDNS (TZO.com)



## The Setup Tab - MAC Address Clone

A MAC address is a 12-digit code assigned to a unique piece of hardware for identification, like a social security number. Some ISPs will require you to register a MAC address in order to access the Internet. If you do not wish to re-register the MAC address with your ISP, you may assign the MAC address currently registered with your ISP to the Router using the MAC Address Clone feature.

### MAC Clone

To use MAC address cloning, select **Enable**. Otherwise, keep the default, **Disable**.

**User Defined Entry.** Enter the MAC Address registered with your ISP. Then click the **Save Settings** button.

**Clone Your PC's MAC.** If you want to clone the MAC address of the PC you are currently using to configure the Router, then click the **Clone Your PC's MAC** button. The Router will automatically detect your PC's MAC address, so you do NOT have to call your ISP to change the registered MAC address to the Router's MAC address. It is recommended that the PC registered with the ISP is used to open the *MAC Address Clone* screen.

When you have finished making changes to this screen, click the **Save Settings** button to save the changes, or click the **Cancel Changes** button to undo your changes. For help information, click **Help**.



Figure 5-9: Setup Tab - MAC Address Clone

*mac address: the unique address that a manufacturer assigns to each networking device.*

## The Wireless Tab - Basic Wireless Settings

The basic settings for wireless networking are set on this screen.

**Wireless Network Mode.** From this drop-down menu, you can select the wireless standards running on your network. If you have both 802.11g and 802.11b devices in your network, keep the default setting, **Mixed**. If you have only 802.11g devices, select **G-Only**. If you have only 802.11b devices, select **B-Only**. If you do not have any 802.11g and 802.11b devices in your network, select **Disable**.

**Wireless Network Name (SSID).** The SSID is the network name shared among all points in a wireless network. The SSID must be identical for all devices in the wireless network. It is case-sensitive and must not exceed 32 characters (use any of the characters on the keyboard). Make sure this setting is the same for all points in your wireless network. For added security, you should change the default SSID (**linksys**) to a unique name.

**Wireless Channel.** Select the appropriate channel from the list provided to correspond with your network settings. All devices in your wireless network must be broadcast on the same channel in order to function correctly.

**Wireless SSID Broadcast.** When wireless clients survey the local area for wireless networks to associate with, they will detect the SSID broadcast by the Router. To broadcast the Router's SSID, keep the default setting, **Enable**. If you do not want to broadcast the Router's SSID, then select **Disable**.

When you have finished making changes to this screen, click the **Save Settings** button to save the changes, or click the **Cancel Changes** button to undo your changes. For help information, click **Help**.

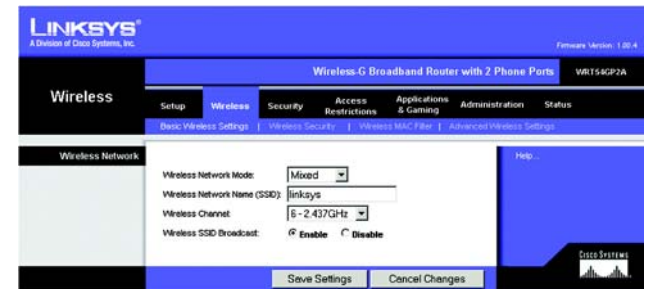

Figure 5-10: Wireless Tab - Basic Wireless Settings

## The Wireless Tab - Wireless Security

These settings configure the security of your wireless network. There are four wireless security mode options supported by the Router: WPA Pre-Shared Key, WPA RADIUS, RADIUS, and WEP. (WPA stands for Wi-Fi Protected Access, which is a security standard stronger than WEP encryption. WEP stands for Wired Equivalent Privacy, while RADIUS stands for Remote Authentication Dial-In User Service.) These four are briefly discussed here. For detailed instructions on configuring wireless security for the Router, turn to “Appendix B: Wireless Security.”

**WPA Pre-Shared Key.** WPA offers two encryption methods, TKIP and AES, with dynamic encryption keys. Select the type of algorithm, TKIP or AES. Enter a WPA Shared Key of 8-63 characters. Then enter a Group Key Renewal period, which instructs the Router how often it should change the encryption keys.

When you have finished making changes to this screen, click the **Save Settings** button to save the changes, or click the **Cancel Changes** button to undo your changes. For help information, click **Help**.

**WPA RADIUS.** This option features WPA used in coordination with a RADIUS server. (This should only be used when a RADIUS server is connected to the Router.) First, select the type of WPA algorithm you want to use, TKIP or AES. Enter the RADIUS server’s IP Address and port number, along with the key shared between the Router and the server. Last, enter the Key Renewal Timeout period, which instructs the Router how often it should change the encryption keys.

When you have finished making changes to this screen, click the **Save Settings** button to save the changes, or click the **Cancel Changes** button to undo your changes. For help information, click **Help**.

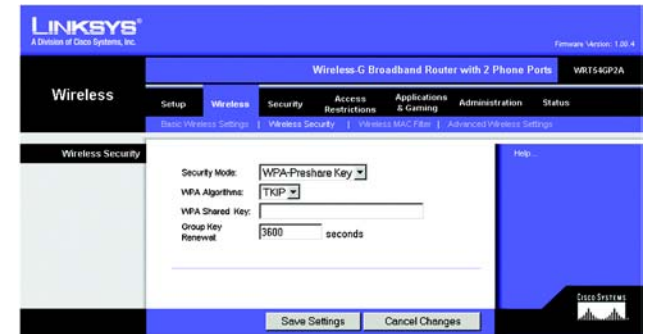

Figure 5-11: Wireless Tab - Wireless Security (WPA Pre-Shared Key)



Figure 5-12: Wireless Tab - Wireless Security (WPA RADIUS)

**RADIUS.** This option features WEP used in coordination with a RADIUS server. (This should only be used when a RADIUS server is connected to the Router.) First, enter the RADIUS server's IP Address and port number, along with the key shared between the Router and the server. Then, to indicate which WEP key to use, select a Default Transmit Key number. Select the appropriate level of WEP encryption, **64 bits 10 hex digits** or **128 bits 26 hex digits**. If you want to use a Passphrase, then enter it in the *Passphrase* field and click the **Generate** button. If you want to manually enter the WEP keys, then enter them in the *Key 1-4* fields.

When you have finished making changes to this screen, click the **Save Settings** button to save the changes, or click the **Cancel Changes** button to undo your changes. For help information, click **Help**.



Figure 5-13: Wireless Tab - Wireless Security (RADIUS)

**WEP.** WEP is a basic encryption method, which is not as secure as WPA. To indicate which WEP key to use, select a Default Transmit Key number. Select the appropriate level of WEP encryption, **64 bits 10 hex digits** or **128 bits 26 hex digits**. If you want to use a Passphrase, then enter it in the *Passphrase* field and click the **Generate** button. If you want to manually enter the WEP keys, then enter them in the *Key 1-4* fields.

When you have finished making changes to this screen, click the **Save Settings** button to save the changes, or click the **Cancel Changes** button to undo your changes. For help information, click **Help**.



Figure 5-14: Wireless Tab - Wireless Security (WPA RADIUS)

## The Wireless Tab - Wireless MAC Filter

Wireless access can be filtered by using the MAC addresses of the wireless devices transmitting within your network's radius.

**Wireless MAC Filter.** To filter wireless users by MAC Address, either permitting or blocking access, click **Enable**. If you do not wish to filter users by MAC Address, select **Disable**.

**Prevent.** Clicking this button will block wireless access by MAC Address.

**Permit Only.** Clicking this button will allow wireless access by MAC Address.

**Edit MAC Address Filter List.** Clicking this button will open the MAC Address Filter List. On this screen, you can list users whose wireless access you to permit or block.

For added convenience, click the **Wireless Client MAC List** button to display a list of wireless network users by MAC Address. Then click the *Enable MAC Filter* checkbox for any device you want to add to the MAC Address Filter List. To update the information on this list, click the **Refresh** button. When you have finished making changes to the *Wireless Client MAC List* screen, click the **Update Filter List** button to save the changes. Click the **Close** button to return to the *MAC Address Filter List* screen.

When you have finished making changes to the *MAC Address Filter List* screen, click the **Save Settings** button to save the changes, or click the **Cancel Changes** button to undo your changes.

When you have finished making changes to the *Wireless MAC Filter* screen, click the **Save Settings** button to save the changes, or click the **Cancel Changes** button to undo your changes. For help information, click **Help**.



Figure 5-15: Wireless Tab - Wireless MAC Filter

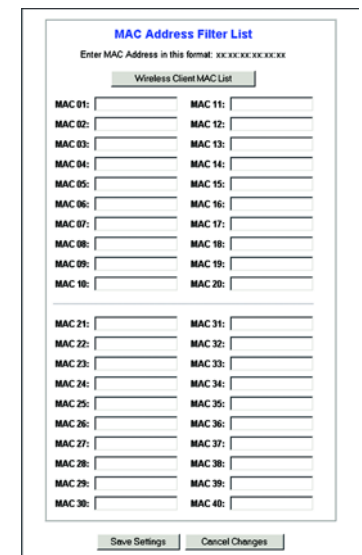

Figure 5-16: MAC Address Filter List

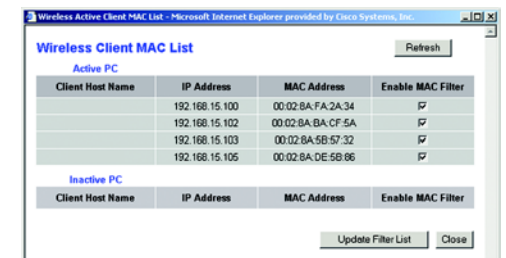

Figure 5-17: Wireless Client MAC List

## The Wireless Tab - Advanced Wireless Settings

This tab is used to set up the Router's advanced wireless functions. These settings should only be adjusted by an expert administrator as incorrect settings can reduce wireless performance.

**Authentication Type.** The default is set to **Auto**, which allows either Open System or Shared Key authentication to be used. With **Open System** authentication, the sender and the recipient do NOT use a WEP key for authentication. With **Shared Key** authentication, the sender and recipient use a WEP key for authentication.

**Transmission Rate.** The rate of data transmission should be set depending on the speed of your wireless network. You can select from a range of transmission speeds, or you can select **Auto** to have the Router automatically use the fastest possible data rate and enable the Auto-Fallback feature. Auto-Fallback will negotiate the best possible connection speed between the Router and a wireless client. The default value is **Auto**.

**Beacon Interval.** Enter a value between 1 and 65,535 milliseconds. The Beacon Interval value indicates the frequency interval of the beacon. A beacon is a packet broadcast by the Router to synchronize the wireless network. The default value is **100**.

**DTIM Interval.** This value, between 1 and 255, indicates the interval of the Delivery Traffic Indication Message (DTIM). A DTIM field is a countdown field informing clients of the next window for listening to broadcast and multicast messages. When the Router has buffered broadcast or multicast messages for associated clients, it sends the next DTIM with a DTIM Interval value. Its clients hear the beacons and awaken to receive the broadcast and multicast messages. The default value is **3**.

**Fragmentation Threshold.** This value specifies the maximum size for a packet before data is fragmented into multiple packets. If you experience a high packet error rate, you may slightly increase the Fragmentation Threshold. Setting the Fragmentation Threshold too low may result in poor network performance. Only minor reduction of the default value is recommended. In most cases, it should remain at its default value of **2346**.

**RTS Threshold.** Should you encounter inconsistent data flow, only minor reduction of the default value, **2347**, is recommended. If a network packet is smaller than the preset RTS threshold size, the RTS/CTS mechanism will not be enabled. The Router sends Request to Send (RTS) frames to a particular receiving station and negotiates the sending of a data frame. After receiving an RTS, the wireless station responds with a Clear to Send (CTS) frame to acknowledge the right to begin transmission. The RTS Threshold value should remain at its default value of **2347**.

When you have finished making changes to this screen, click the **Save Settings** button to save the changes, or click the **Cancel Changes** button to undo your changes. For help information, click **Help**.

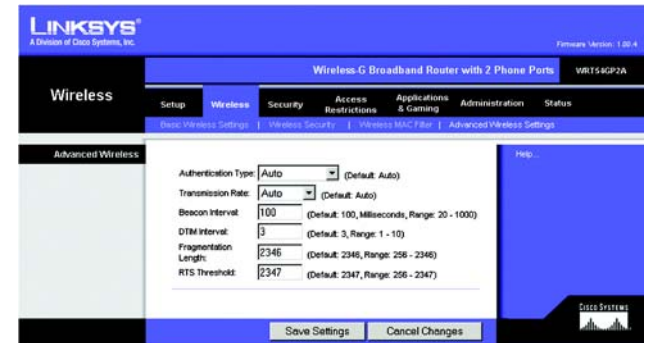

Figure 5-18: Wireless Tab - Advanced Wireless Settings

## The Security Tab - Firewall

When you click the Security tab, you will see the *Firewall* screen. The Router's firewall enhances the security of your network. You can also enable a variety of filters to further protect your network and block anonymous Internet requests.

### Firewall

The firewall uses Stateful Packet Inspection (SPI) to check the incoming data transmissions before allowing them to enter your network. To enhance the security of your network, this feature is enabled by default and cannot be disabled.

### Additional Filters

**Filter Proxy.** Use of WAN proxy servers may compromise the Router's security. If you deny proxy, you will block access to any WAN proxy servers. Click the checkbox to enable proxy filtering.

**Filter Cookies.** A cookie is data stored on your PC and used by Internet sites when you interact with them. Click the checkbox to enable cookie filtering.

**Filter Java Applets.** Java is a programming language for websites. If you deny Java Applets, you run the risk of not having access to Internet sites created using this programming language. Click the checkbox to enable Java Applet filtering.

**Filter ActiveX.** ActiveX is a programming language for websites. If you deny ActiveX, you run the risk of not having access to Internet sites created using this programming language. Click the checkbox to enable ActiveX filtering.

**Filter Multicast.** Multicasting allows for multiple transmissions to specific recipients at the same time. If multicasting is permitted, then the Router will allow IP multicast packets to be forwarded to the appropriate computers. Click the checkbox to enable multicast filtering.

### Block WAN Requests

**Block Anonymous Internet Requests.** This keeps your network from being "pinged" or detected and reinforces your network security by hiding your network ports, so it is more difficult for intruders to work their way into your network. Click the checkbox to block anonymous Internet requests. This feature is enabled by default.

When you have finished making changes to this screen, click the **Save Settings** button to save the changes, or click the **Cancel Changes** button to undo your changes. For help information, click **Help**.



Figure 5-19: Security Tab - Firewall

*spi (stateful packet inspection) firewall: A technology that inspects incoming packets of information before allowing them to enter the network*



## The Security Tab - VPN

The *VPN* screen allows you to allow VPN tunnels using IPSec, PPTP, or L2TP protocols to pass through the Router.

### VPN Passthrough

**IPSec Passthrough.** IPSec (Internet Protocol Security) is a suite of protocols used to implement secure exchange of packets at the IP layer. To allow IPSec Passthrough, click the **Enable** button. To disable IPSec Passthrough, click the **Disable** button.

**PPTP Passthrough.** PPTP (Point-to-Point Tunneling Protocol) Passthrough allows the Point-to-Point (PPP) to be tunneled through an IP network. To allow PPTP Passthrough, click the **Enable** button. To disable PPTP Passthrough, click the **Disable** button.

**L2TP Passthrough.** Layer 2 Tunneling Protocol Passthrough is the method used to enable Point-to-Point (PPP) sessions via the Internet on the Layer 2 level. To allow L2TP Passthrough, click the **Enable** button. To disable L2TP Passthrough, click the **Disable** button.

When you have finished making changes to this screen, click the **Save Settings** button to save the changes, or click the **Cancel Changes** button to undo your changes. For help information, click **Help**.

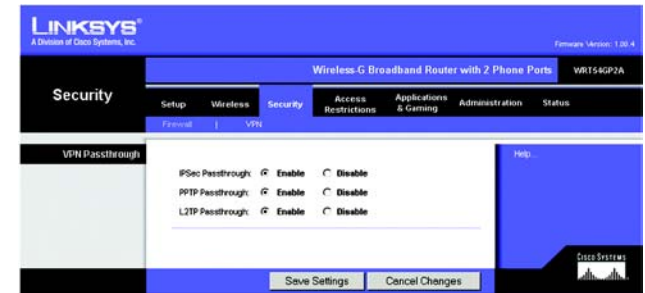

Figure 5-20: Security Tab - VPN

*vpn:* a security measure to protect data as it leaves one network and goes to another over the Internet

*ipsec:* a VPN protocol used to implement secure exchange of packets at the IP layer

*pptp:* a VPN protocol that allows the Point to Point Protocol (PPP) to be tunneled through an IP network. This protocol is also used as a type of broadband connection in Europe



## The Access Restrictions Tab - Internet Access

The *Internet Access* screen allows you to block or allow specific kinds of Internet usage and traffic, such as Internet access, designated services, and websites during specific days and times.



**NOTE:** If you have an AT&T CallVantage Service account, contact AT&T technical support at 1-866-596-8464 before you enable an Internet Access Policy.

### Internet Access

**Internet Access Policy.** Access can be managed by a policy. Use the settings on this screen to establish an access policy (after the **Save Settings** button is clicked). Selecting a policy from the drop-down menu will display that policy's settings. To delete a policy, select that policy's number and click the **Delete** button. To view all the policies, click the **Summary** button.

**Status.** Policies are disabled by default. To enable a policy, select the policy number from the drop-down menu, and click the radio button beside *Enable*. To disable a policy, select the policy number from the drop-down menu, and click the radio button beside *Disable*.

To create an Internet Access Policy:

1. Select a number from the *Internet Access Policy* drop-down menu.
2. To enable this policy, click the radio button beside *Enable*.
3. Enter a Policy Name in the field provided.

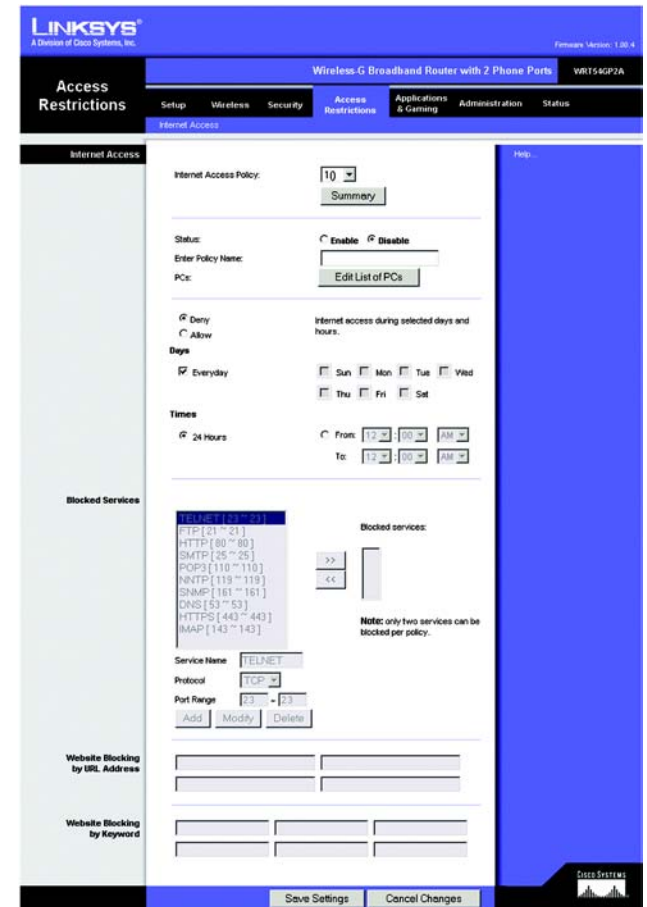

Figure 5-21: Access Restrictions Tab - Internet Access

No.	Policy Name	Days	Time of Day
1.	--	SMTWTFSS	--
2.	--	SMTWTFSS	--
3.	--	SMTWTFSS	--
4.	--	SMTWTFSS	--
5.	--	SMTWTFSS	--
6.	--	SMTWTFSS	--
7.	--	SMTWTFSS	--
8.	--	SMTWTFSS	--
9.	--	SMTWTFSS	--
10.	--	SMTWTFSS	--

Figure 5-22: Internet Policy Summary

- Click the **Edit List of PCs** button to select which PCs will be affected by the policy. The *List of PCs* screen will appear. You can select a PC by MAC Address or IP Address. You can also enter a range of IP Addresses if you want this policy to affect a group of PCs. After making your changes, click the **Save Settings** button to apply your changes or **Cancel Changes** to cancel your changes. Click the **Close** button to return to the *Internet Access* screen.
- Click the appropriate option, **Deny** or **Allow**, depending on whether you want to block or allow Internet access for the PCs you listed on the *List of PCs* screen.
- Decide which days and what times you want this policy to be enforced. Select the individual days during which the policy will be in effect, or select **Everyday**. Then enter a range of hours and minutes during which the policy will be in effect, or select **24 Hours**.
- In the *Blocked Services* section, you can filter access to various services accessed over the Internet, such as FTP or telnet. Select the service from the drop-down menu listing your choice of services. Then click the >> button to add the service to the *Blocked services* list. (You can block up to two services per policy.)

If you want to remove a service from the *Blocked services* list, then select it and click the << button.

If the service you want is not available, then you can add a service. Enter the service's name in the *Service Name* field. Select its protocol from the *Protocol* drop-down menu, and enter its range in the *Port Range* fields. Then click the **Add** button.

If you want to edit a service's settings, then select the service in the drop-down menu on the left. Change its name, protocol setting, or port range. Then click the **Modify** button.

To delete a service, select it from the list on the left. Then click the **Delete** button.

- If you want to block websites with specific URL addresses, enter each URL in a separate field next to *Website Blocking by URL Address*.
- If you want to block websites using specific keywords, enter each keyword in a separate field next to *Website Blocking by Keyword*.
- Click the **Save Settings** button to save the policy's settings. To cancel the policy's settings, click the **Cancel Changes** button.
- Repeat steps 1-10 to create more policies.

When you have finished making changes to this screen, click the **Save Settings** button to save the changes, or click the **Cancel Changes** button to undo your changes. For help information, click **Help**.

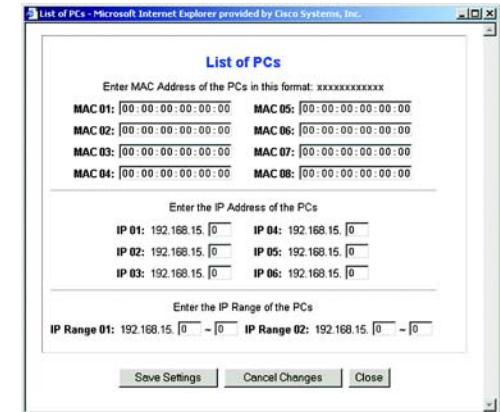

Figure 5-23: List of PCs

## The Applications & Gaming Tab - Port Range Forward

When you click the Applications & Gaming tab, you will see the *Port Range Forward* screen. Port range forwarding sets up public services on your network, such as web servers, ftp servers, e-mail servers, or other specialized Internet applications. (Specialized Internet applications are any applications that use Internet access to perform functions such as videoconferencing or online gaming. Some Internet applications may not require any forwarding.) When users send this type of request to your network via the Internet, the Router will forward those requests to the appropriate PC.

Before using forwarding, you should assign a static IP address to the designated PC.

If you need to forward all ports to one PC, click the **DMZ** tab.

### Port Range Forward

#### Port Range

To add a server using Port Range Forwarding, complete the following fields:

**Application.** Enter the name of the application.

**Start and End.** Enter the number or range of external port(s) used by the server or Internet application. Check with the Internet application software documentation for more information.

**Protocol.** Select the protocol **TCP** or **UDP**, or select **Both**.

**IP Address.** Enter the IP address of the server that you want the Internet users to be able to access. To find the IP address, go to "Appendix D: Finding the MAC Address and IP Address for Your Ethernet Adapter."

**Enable.** Check the **Enable** box to enable the application you have defined. Port Range Forwarding for a specific application will not function if its Enable button is left unchecked. This is disabled (unchecked) by default.

When you have finished making changes to this screen, click the **Save Settings** button to save the changes, or click the **Cancel Changes** button to undo your changes. For help information, click **Help**.

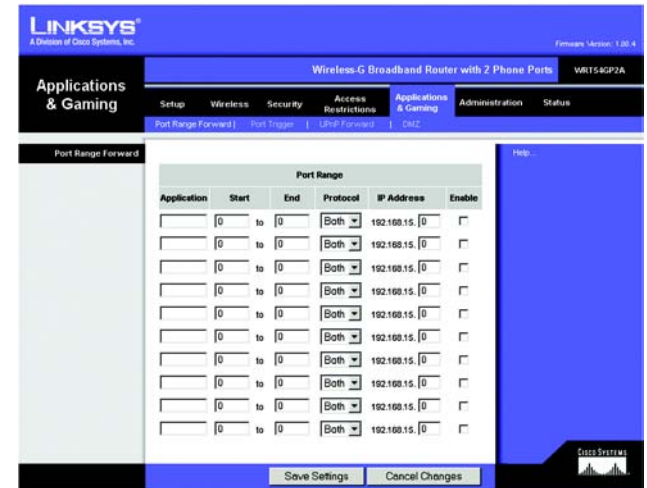

Figure 5-24: Applications & Gaming Tab - Port Range Forward

*tcp: a network protocol for transmitting data that requires acknowledgement from the recipient of data sent*

*udp: a network protocol for transmitting data that does not require acknowledgement from the recipient of the data that is sent.*

*ip (internet protocol): a protocol used to send data over a network*

*ip address: the address used to identify a computer or device on a network*

## The Applications & Gaming Tab - Port Trigger

The *Port Trigger* screen allows the Router to watch outgoing data for specific port numbers. The IP address of the computer that sends the matching data is remembered by the Router, so that when the requested data returns through the Router, the data is pulled back to the proper computer by way of IP address and port mapping rules.

### Port Trigger

**Application.** Enter the application name of the trigger.

### Triggered Range

**Protocol.** Select the protocol **TCP** or **UDP**.

For each application, list the triggered port number range. Check with the Internet application documentation for the port number(s) needed.

**Start Port.** Enter the starting port number of the Triggered Range.

**End Port.** Enter the ending port number of the Triggered Range.

### Forwarded Range

**Protocol.** Select the protocol **TCP** or **UDP**.

For each application, list the forwarded port number range. Check with the Internet application documentation for the port number(s) needed.

**Start Port.** Enter the starting port number of the Forwarded Range.

**End Port.** Enter the ending port number of the Forwarded Range.

**Enable.** Check the **Enable** box to enable the application you have defined. Port Triggering for a specific application will not function if its Enable box is left unchecked. This is disabled (unchecked) by default.

When you have finished making changes to this screen, click the **Save Settings** button to save the changes, or click the **Cancel Changes** button to undo your changes. For help information, click **Help**.

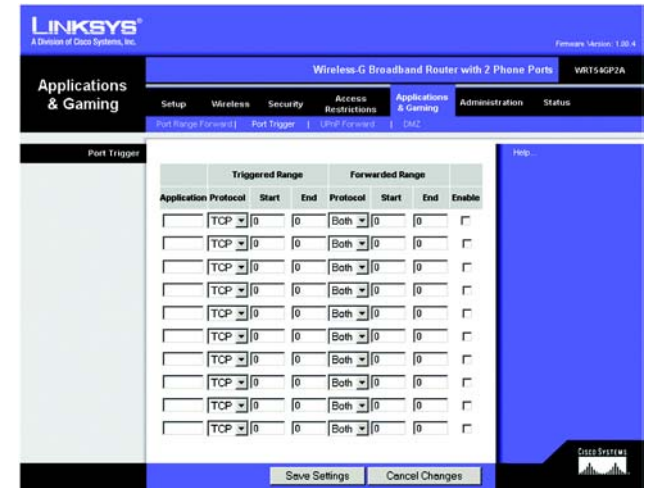

Figure 5-25: Applications & Gaming Tab - Port Trigger

## The Applications & Gaming Tab - UPnP Forward

The *UPnP Forward* screen displays preset application settings as well as options to customize port services for other applications.

### UPnP Forward

**Application.** Ten applications are preset. For custom applications, enter the name of your application in one of the available fields.

The preset applications are among the most widely used Internet applications. They include the following:

**FTP** (File Transfer Protocol). A protocol used to transfer files over a TCP/IP network (Internet, UNIX, etc.). For example, after developing the HTML pages for a website on a local machine, they are typically uploaded to the web server using FTP.

**Telnet.** A terminal emulation protocol commonly used on Internet and TCP/IP-based networks. It allows a user at a terminal or computer to log onto a remote device and run a program.

**SMTP** (Simple Mail Transfer Protocol). The standard e-mail protocol on the Internet. It is a TCP/IP protocol that defines the message format and the message transfer agent (MTA), which stores and forwards the mail.

**DNS** (Domain Name System). The way that Internet domain names are located and translated into IP addresses. A domain name is a meaningful and easy-to-remember “handle” for an Internet address.

**TFTP** (Trivial File Transfer Protocol). A version of the TCP/IP FTP protocol that has no directory or password capability.

**Finger.** A UNIX command widely used on the Internet to find out information about a particular user, such as a telephone number, whether the user is currently logged on, and the last time the user was logged on. The person being “fingered” must have placed his or her profile on the system in order for the information to be available. Fingering requires entering the full user@domain address.

**HTTP** (HyperText Transport Protocol). The communications protocol used to connect to servers on the World Wide Web. Its primary function is to establish a connection with a web server and transmit HTML pages to the client web browser.

**POP3** (Post Office Protocol 3). A standard mail server commonly used on the Internet. It provides a message store that holds incoming e-mail until users log on and download it. POP3 is a simple system with little selectivity. All pending messages and attachments are downloaded at the same time. POP3 uses the SMTP messaging protocol.

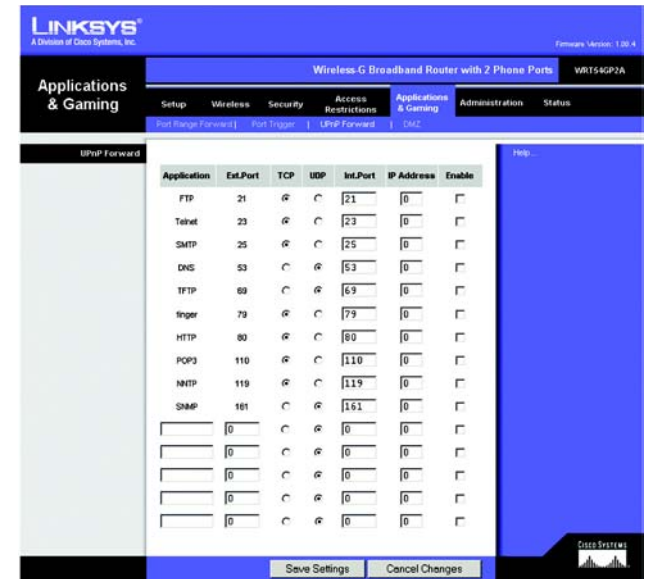

Figure 5-26: Applications & Gaming Tab - UPnP Forward

**NNTP** (Network News Transfer Protocol). The protocol used to connect to Usenet groups on the Internet. Usenet newsreaders support the NNTP protocol.

**SNMP** (Simple Network Management Protocol). A widely used network monitoring and control protocol. Data is passed from SNMP agents, which are hardware and/or software processes reporting activity in each network device (hub, router, bridge, etc.) to the workstation console used to oversee the network. The agents return information contained in a MIB (Management Information Base), which is a data structure that defines what is obtainable from the device and what can be controlled (turned off, on, etc.).

**Ext. Port.** Enter the number of the external port used by the server in the *Ext. Port* column. Check with the Internet application documentation for more information.

**TCP or UDP.** Select the protocol **UDP** or **TCP** for each application. You cannot select both protocols.

**Int. Port.** Enter the number of the internal port used by the server in the *Int. Port* column. Check with the Internet application software documentation for more information.

**IP Address.** Enter the IP address of the server that you want the Internet users to be able to access. To find the IP address, go to "Appendix D: Finding the MAC Address and IP Address for Your Ethernet Adapter."

**Enable.** Check the **Enable** box to enable the application you have defined. UPnP Forwarding for a specific application will not function if its Enable box is left unchecked. This is disabled (unchecked) by default.

When you have finished making changes to this screen, click the **Save Settings** button to save the changes, or click the **Cancel Changes** button to undo your changes. For help information, click **Help**.

## The Applications & Gaming Tab - DMZ

The *DMZ* screen allows one local user to be exposed to the Internet for use of a special-purpose service such as Internet gaming and videoconferencing. DMZ hosting forwards all the ports at the same time to one PC. Port Range Forwarding is more secure because it only opens the ports you want to have opened, while DMZ hosting opens all the ports of one computer, exposing the computer to the Internet.

Any PC whose port is being forwarded must have its DHCP client function disabled and should have a new static IP address assigned to it because its IP address may change when using the DHCP function.

### DMZ

**DMZ.** To use this feature, select **Enable**. To disable DMZ hosting, select **Disable**.

**DMZ Host IP Address.** To expose one PC, enter the computer's IP address. To get the IP address of a computer, refer to "Appendix D: Finding the MAC Address and IP Address for Your Ethernet Adapter." Deactivate DMZ by entering **0** in the field.

When you have finished making changes to this screen, click the **Save Settings** button to save the changes, or click the **Cancel Changes** button to undo your changes. For help information, click **Help**.

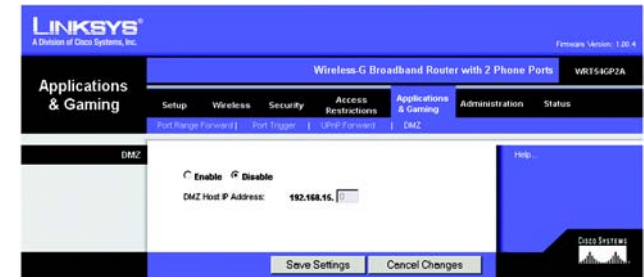

Figure 5-27: Applications & Gaming Tab - DMZ



## The Administration Tab - Management

When you click the Administration tab, you will see the *Management* screen. This screen allows you to change the Router's access settings as well as configure the SNMP (Simple Network Management Protocol) and UPnP (Universal Plug and Play) features.

### Router Password

### Local Router Access

To ensure the Router's security, you will be asked for your password when you access the Router's Web-based Utility. The default password is **admin**.

**Router Password.** It is recommended that you change the default password to one of your choice.

**Re-enter to confirm.** Re-enter the Router's new Password to confirm it.

### Remote Router Access

This feature allows you to access the Router from a remote location, via the Internet.

**Remote Management.** This feature allows you to manage the Router from a remote location, via the Internet. To enabled Remote Management, click the **Enable** radio button.

**Management Port.** Enter the port number you will use to remotely access the Router.



**NOTE:** When you are in a remote location and wish to manage the Router, enter *http://<Internet IP Address>:port*. Enter the Router's specific Internet IP address in place of *<Internet IP Address>*, and enter the Administration Port number in place of the word *port*.

**Use https.** A Secure Sockets Layer (SSL) connection enhances the security of your data transmissions. If you want to use an SSL connection to remotely manage the Router, click the checkbox.



**NOTE:** If the https feature is enabled, then enter *https://<Internet IP Address>:port* when you are in a remote location and wish to manage the Router. Enter the Router's specific Internet IP address in place of *<Internet IP Address>*, and enter the Administration Port number in place of the word *port*.

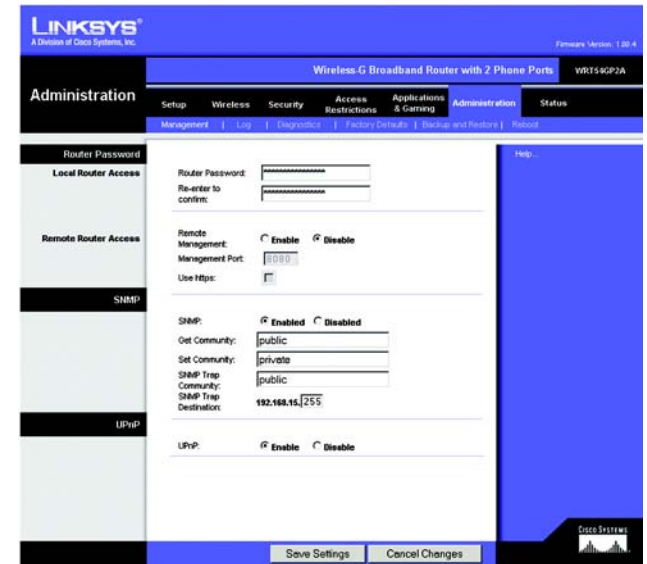

Figure 5-28: Administration Tab - Management



## SNMP

SNMP, Simple Network Management Protocol, is a network protocol that provides network administrators with the ability to monitor the status of the Router and receive notification of any critical events as they occur on the network.

**SNMP.** To enable SNMP, check the **Enabled** box. To configure SNMP, complete all fields on this screen. To disable the SNMP agent, remove the checkmark.

**Get Community.** Enter the password that allows read-only access to the Router's SNMP information. The default name is **public**.

**Set Community.** Enter the password that allows read/write access to the Router's SNMP information. The default name is **private**. A name must be entered in this field.

**SNMP Trap Community.** Enter the password required by the remote host computer that will receive trap messages or notices sent by the Router.

**SNMP Trap Destination.** Enter the IP address of the remote host computer that will receive the trap messages.

## UPnP

**UPnP.** UPnP allows Windows XP and Me to automatically configure the Router for various Internet applications, such as gaming and videoconferencing. To enable UPnP, click the **Enable** radio button.

When you have finished making changes to this screen, click the **Save Settings** button to save the changes, or click the **Cancel Changes** button to undo your changes. For help information, click **Help**.

## The Administration Tab - Log

The *Log* screen provides you with a log of all incoming and outgoing URLs or IP addresses for your Internet connection.

### Log

**Log.** To keep activity logs, select the **Enable** radio button. With logging enabled, you can choose to view temporary logs or keep a permanent record using the Logviewer software. Click the **Disable** button to disable this function.

**Log Viewer IP Address.** For a permanent record of these logs, Logviewer software must be used. This software is downloadable from the Linksys website, [www.linksys.com](http://www.linksys.com). The Logviewer saves all incoming and outgoing activity in a permanent file on your PC's hard drive. In the *Log Viewer IP Address* field, enter the fixed IP address of the PC running the Logviewer software. The Router will now send updated logs to that PC.

**Incoming Log.** Click the **Incoming Log** button to view a temporary log of the Source IP addresses and Destination Port Numbers for all the incoming Internet traffic. Click the **Refresh** button to update the log.

**Outgoing Log.** Click the **Outgoing Log** button to view a temporary log of all the URLs and IP addresses of Internet sites that users on your network have accessed. The LAN IP address, Destination URL/IP, and Service/Port Number for each site are listed. Click the **Refresh** button to update the log.

When you have finished making changes to this screen, click the **Save Settings** button to save the changes, or click the **Cancel Changes** button to undo your changes. For help information, click **Help**.



Figure 5-29: Administration Tab - Log

## The Administration Tab - Diagnostics

The diagnostic tests (Ping and Traceroute) allow you to check the connections of your network components.

### Ping Test

#### Ping Parameters

**Ping.** The Ping test will check the status of a connection. Click the **Ping** button to open the *Ping Test* screen. Enter the IP address or domain name of the PC whose connection you wish to test and how many times you wish to test it, **5**, **10**, or **unlimited**. Then, click the **Ping** button. To stop the test, click the **Stop** button. Click the **Clear Log** button to clear the screen. Click the **Close** button to return to the *Diagnostics* screen.

### Traceroute Test

#### Traceroute Parameters

**Traceroute.** To test the performance of a connection, click the **Traceroute** button. Enter the IP address or domain name of the PC whose connection you wish to test and click the **Traceroute** button. To stop the test, click the **Stop** button. Click the **Clear Log** button to clear the screen. Click the **Close** button to return to the *Diagnostics* screen.

For help information, click **Help**.



Figure 5-30: Administration Tab - Diagnostics



Figure 5-31: Ping Test

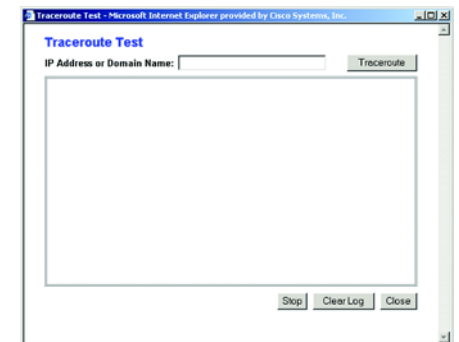

Figure 5-32: Traceroute Test

## The Administration Tab - Factory Defaults

The *Factory Defaults* screen allows you to restore the Router's configuration to its factory default settings.

### Factory Defaults

**Restore Factory Defaults.** To clear all of the Router's settings and reset them to its factory defaults, click the **Yes** radio button.

After you have clicked the **Yes** radio button, click the **Save Settings** button to restore the Router to its factory defaults, or click the **Cancel Changes** button to undo your change. For help information, click **Help**.



**NOTE:** Do not restore the factory defaults unless you are having difficulties with the Router and have exhausted all other troubleshooting measures. Once the Router is reset, you will have to re-enter all of your configuration settings. (However, if you have an active Internet phone service account, the Router will automatically download its Internet phone service settings once it is connected to the Internet again.)



Figure 5-33: Administration Tab - Factory Defaults

## The Administration Tab - Backup and Restore

The *Backup and Restore* screen allows you to back up and restore the Router's configuration.

### Backup and Restore

**Please select a file to restore.** In the field provided, enter the name of the configuration file you want to restore, or click the **Browse** button to find this file.

**Backup.** To create a backup configuration file, click the **Backup** button, and follow the on-screen instructions.

**Restore.** After you have selected the appropriate file, click the **Restore** button, and follow the on-screen instructions.

For help information, click **Help**.

## The Administration Tab - Reboot

The *Reboot* screen allows you to remotely reboot the Router from your computer.

### Reboot

**Device Reboot.** Click the **Yes radio** button if you want to reboot the Router. Otherwise, keep the default setting, **No**.

After you have clicked the **Yes** radio button, click the **Save Settings** button to reboot the Router, or click the **Cancel Changes** button to undo your change. For help information, click **Help**.

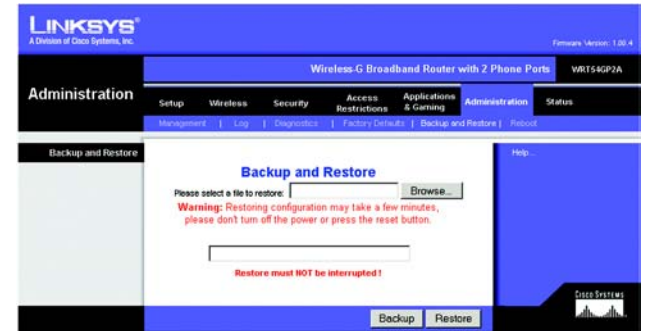

Figure 5-34: Administration Tab - Backup and Restore



Figure 5-35: Administration Tab - Reboot

## The Status Tab - Router

The *Router* screen displays information about the Router and its current settings.

### Router Information

**Current Firmware Version.** This shows the version and date of the firmware that is currently installed.

**Previous Firmware Version.** This shows the version and date of the firmware that was previously installed.

**Current Time.** The current time and date are displayed here.

**MAC Address.** The MAC Address of the Router's Internet interface is displayed here.

**Router Name.** This shows the name you have assigned to the Router.

**Host Name.** The Host Name for the Router is shown here.

**Domain Name.** The Domain Name for the Router is displayed here.

### Internet

#### Configuration Type

**Login Type.** This indicates the type of Internet connection you are using.

**Login Status.** For these dial-up style connections, PPPoE and PPTP, the status of the connection is displayed, and there is a Connect button to click if there is no connection and you want to establish an Internet connection.

**IP Address.** The Router's Internet IP Address is displayed here.

**Subnet Mask and Default Gateway.** The Router's Subnet Mask and Default Gateway address are shown here.

**DNS 1-2.** Shown here are the DNS (Domain Name System) IP addresses currently used by the Router.

**DHCP Release.** For a DHCP connection, click the **DHCP Release** button to release the current IP address of the device connected to the Router's Internet port.

**DHCP Renew.** For a DHCP connection, click the **DHCP Renew** button to replace the current IP address—of the device connected to the Router's Internet port—with a new IP address.

Click the **Refresh** button to update the on-screen information. For help information, click **Help**.

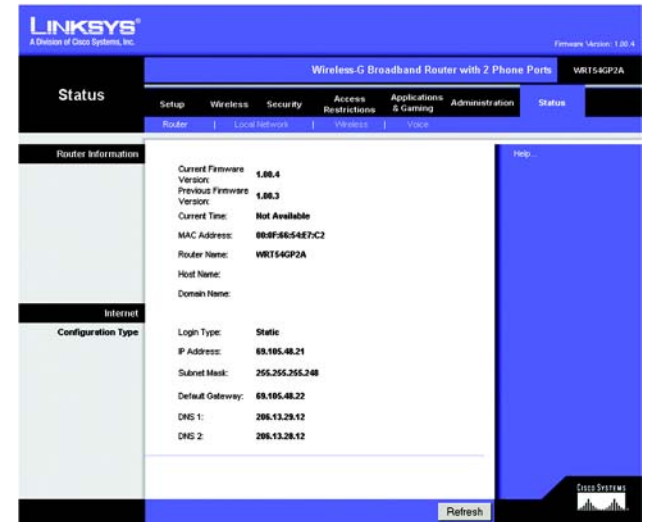

Figure 5-36: Status Tab - Router



**NOTE:** The on-screen information will vary depending on the Internet Connection Type selected on the *Setup* screen.

## The Status Tab - Local Network

The *Local Network* screen displays information about the local network.

### Local Network

**MAC Address.** The MAC Address of the Router's LAN (local area network) interface is displayed here.

**IP Address.** The Router's local IP Address is shown here.

**Subnet Mask.** The Router's Subnet Mask is shown here.

**DHCP Server.** The status of the DHCP server is displayed here.

**Start IP Address.** This is the starting IP address of the range assigned by the Router.

**End IP Address.** This is the last IP address of the range assigned by the Router.

**DHCP Clients Table.** Click the **DHCP Clients Table** button to view a list of PCs that have been assigned IP addresses by the Router. The *DHCP Active IP Table* screen lists the DHCP Server IP Address, Client Host Names, IP Addresses, MAC Addresses, and Expiration dates. Click the **Delete** checkbox to delete a DHCP client listing. Click the **Refresh** button to update the information. Click the **Close** button to return to the *Local Network* screen.

Click the **Refresh** button to update the on-screen information. For help information, click **Help**.

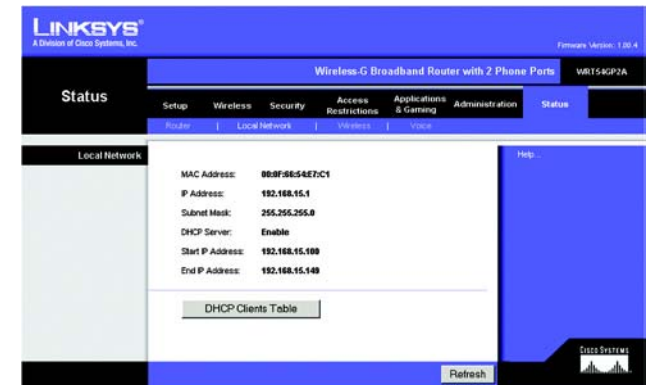

Figure 5-37: Status Tab - Local Network

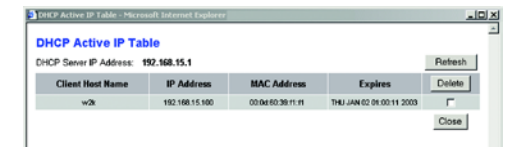

Figure 5-38: DHCP Clients Table

## The Status Tab - Wireless

The *Wireless* screen displays the status of your wireless network.

### Wireless

**Wireless Firmware Version.** This shows the version and date of the wireless firmware that is currently installed.

**MAC Address.** The MAC Address of the Router's wireless interface is displayed here.

**Status.** This indicates the status of the Router's wireless network.

**Mode.** As selected from the Wireless tab, this will display the wireless mode (Mixed, G-Only, or Disabled) used by the network.

**SSID.** As entered on the Wireless tab, this will display the wireless network name or SSID.

**Channel.** As entered on the Wireless tab, this will display the channel on which your wireless network is broadcasting.

**Encryption Function.** As selected on the Security Tab, this will indicate which wireless security method the Router uses.

**Active Client List.** Click the **View** button to display a list of wireless network users by MAC Address. Then click the *Enable MAC Filter* checkbox for any device you want to add to the MAC Address Filter List, which is accessed through the Wireless tab and then the *Wireless MAC Filter* screen. To update the information on this list, click the **Refresh** button. When you have finished making changes to the *Wireless Client MAC List* screen, click the **Update Filter List** button to save the changes. Click the **Close** button to return to the *MAC Address Filter List* screen.

Click the **Refresh** button to update the information on the *Wireless* screen. For help information, click **Help**.



Figure 5-39: Status Tab - Wireless

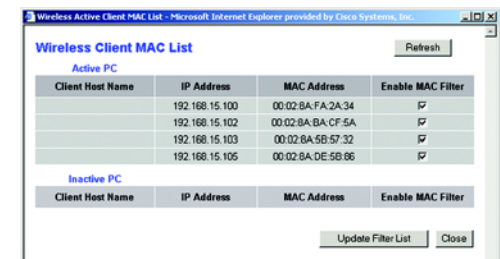

Figure 5-40: Wireless Client MAC List



## The Status Tab - Voice

The *Voice* screen displays information about your Internet phone line(s).

### Auto Config Status

**Auto Config Status.** Each time the Router boots up, it automatically checks to see if it has the latest configuration for Internet phone service. If necessary, the Router will automatically update its configuration. You can make Internet phone calls only if the Router has the most recent configuration.

### User1 Status

**Registration Status.** This indicates whether or not this phone line is registered with AT&T CallVantage Service. If the phone line is not registered and you want Internet phone service, then refer to “Chapter 6: Signing up for AT&T CallVantage<sup>SM</sup> Service.” If the registration status indicates that the registration has failed, then refer to “Appendix A: Troubleshooting.”

**Call1 Status.** The status of the active phone call is shown here.

**Call2 Status.** If you are using call waiting, the status of the incoming phone call is shown here.

### User2 Status

**Registration Status.** This indicates whether or not this phone line is registered with AT&T CallVantage Service. If the phone line is not registered and you want Internet phone service, then refer to “Chapter 6: Signing up for AT&T CallVantage<sup>SM</sup> Service.” If the registration status indicates that the registration has failed, then refer to “Appendix A: Troubleshooting.”

**Call1 Status.** The status of the active phone call is shown here.

**Call2 Status.** If you are using call waiting, the status of the incoming phone call is shown here.

Click the **Refresh** button to update the on-screen information. For help information, click **Help**.



Figure 5-41: Status Tab - Voice

# Chapter 6: Signing up for AT&T CallVantage<sup>sm</sup> Service

## Overview

After you have installed and configured the Router for your Internet connection, you can sign up for Internet phone service or activate your account. Follow these instructions to access the AT&T website.

## Instructions

1. Launch Internet Explorer, and enter **http://www.att.com/linksys** in the *Address* field.

Then press the **Enter** key.

2. You will see two choices. Select the one that applies to you.

If you already have an Internet phone service account with AT&T, then select **I signed up for service and want to activate**.

If you do not have an Internet phone service account with AT&T, then select **I have my Linksys Router and want to sign up for service**.

3. Follow the on-screen instructions.

When you have activated your Internet phone service, the Phone 1 LED on the Router's front panel will light up. When you pick up the phone, you will hear a dial tone. Then you will be able to make Internet phone calls.

If you experience any problems, refer to "Appendix A: Troubleshooting" for more information.



Figure 6-1: Website for AT&T CallVantage Service

# Appendix A: Troubleshooting

This appendix provides solutions to problems that may occur during the installation and operation of the Router. Read the description below to solve your problems. If you can't find an answer here, check the AT&T website at <http://www.usa.att.com/callvantage/faqs/index.jsp> or the Linksys website at [www.linksys.com](http://www.linksys.com).

## Common Problems and Solutions

### 1. *I don't hear a dial tone, and the Phone 1 LED is not lit.*

Go through this checklist until your problem is solved:

- Make sure the telephone is plugged into the Phone 1 port.
- Disconnect and re-connect the RJ-11 telephone cable between the Router and telephone.
- Make sure your telephone is set to its tone setting (not pulse).
- Make sure your network has an active Internet connection. Try to access the Internet, and check to see if the Router's Internet LED is lit. If you do not have a connection, power off your network devices, including the Router and cable/DSL modem. Wait 30 seconds, and power on the cable/DSL modem first. Then power on the Router and other network devices.
- Verify your account information and confirm that the phone line is registered with AT&T.
- If none of the above works, contact AT&T at 1-866-596-8464.

### 2. *The Status - Voice screen of the Web-based Utility says that the registration for my Internet phone line has failed.*

Go through this checklist until your problem is solved:

- Make sure your network has an active Internet connection. Try to access the Internet, and check to see if the Router's Internet LED is lit. If you do not have a connection, power off your network devices, including the Router and cable/DSL modem. Wait 30 seconds, and power on the cable/DSL modem first. Then power on the Router and other network devices.
- Verify your account information and confirm that the phone line is registered with AT&T.
- Make sure that your cable or DSL modem is supported by AT&T.
- If none of the above works, contact AT&T at 1-866-596-8464.

### 3. *I reset the Router to its factory default settings. How do I configure the settings for my Internet phone service?*

If your Internet phone service account is active, the Router will automatically download its Internet phone service settings once it is connected to the Internet again. If you do not have an active Internet phone service account, visit <http://www.att.com/linksys> to sign up for a new account or activate your account. Then follow the on-screen instructions.

**4. I'm trying to access the Router's Web-based Utility, but I do not see the login screen. Instead, I see a screen saying, "404 Forbidden."**

If you are using Windows Explorer, perform the following steps until you see the Web-based Utility's login screen (Netscape Navigator will require similar steps):

- A. Click **File**. Make sure *Work Offline* is NOT checked.
- B. Press **CTRL + F5**. This is a hard refresh, which will force Windows Explorer to load new webpages, not cached ones.
- C. Click **Tools**. Click **Internet Options**. Click the **Security** tab. Click the **Default level** button. Make sure the security level is Medium or lower. Then click the **OK** button.

**5. I need to set a static IP address on a PC.**

The Router, by default, assigns an IP address range of 192.168.15.100 to 192.168.15.150 using the DHCP server on the Router. To set a static IP address, you can only use the ranges 192.168.15.2 to 192.168.15.99 and 192.168.15.151 to 192.168.15.254. Each PC or network device that uses TCP/IP must have a unique address to identify itself in a network. If the IP address is not unique to a network, Windows will generate an IP conflict error message. You can assign a static IP address to a PC by performing the following steps:

For Windows 98 and Millennium:

- A. Click **Start, Setting, and Control Panel**. Double-click **Network**.
- B. In *The following network components are installed* box, select the **TCP/IP->** associated with your Ethernet adapter. If you only have one Ethernet adapter installed, you will only see one TCP/IP line with no association to an Ethernet adapter. Highlight it and click the **Properties** button.
- C. In the *TCP/IP properties* window, select the **IP address** tab, and select **Specify an IP address**. Enter a unique IP address that is not used by any other computer on the network connected to the Router. You can only use an IP address in the ranges 192.168.15.2 to 192.168.15.99 and 192.168.15.151 to 192.168.15.254. Make sure that each IP address is unique for each PC or network device.
- D. Click the **Gateway** tab, and in the *New Gateway* prompt, enter **192.168.15.1**, which is the default IP address of the Router. Click the **Add** button to accept the entry.
- E. Click the **DNS** tab, and make sure the **DNS Enabled** option is selected. Enter the Host and Domain names (e.g., John for Host and home for Domain). Enter the DNS entry provided by your ISP. If your ISP has not provided the DNS IP address, contact your ISP to get that information or go to its website for the information.
- F. Click the **OK** button in the *TCP/IP properties* window, and click **Close** or the **OK** button for the *Network* window.
- G. Restart the computer when asked.

### For Windows 2000:

- A. Click **Start**, **Settings**, and **Control Panel**. Double-click **Network and Dial-Up Connections**.
- B. Right-click the **Local Area Connection** that is associated with the Ethernet adapter you are using, and select the **Properties** option.
- C. In the *Components checked are used by this connection* box, highlight **Internet Protocol (TCP/IP)**, and click the **Properties** button. Select **Use the following IP address** option.
- D. Enter a unique IP address that is not used by any other computer on the network connected to the Router. You can only use an IP address in the ranges 192.168.15.2 to 192.168.15.99 and 192.168.15.151 to 192.168.15.254.
- E. Enter the Subnet Mask, **255.255.255.0**.
- F. Enter the Default Gateway, **192.168.15.1** (Router's default IP address).
- G. Toward the bottom of the window, select **Use the following DNS server addresses**, and enter the Preferred DNS server and Alternative DNS server (provided by your ISP). Contact your ISP or go on its website to find the information.
- H. Click the **OK** button in the *Internet Protocol (TCP/IP) Properties* window, and click the **OK** button in the *Local Area Connection Properties* window.
- I. Restart the computer if asked.

### For Windows XP:

The following instructions assume you are running Windows XP with the default interface. If you are using the Classic interface (where the icons and menus look like previous Windows versions), please follow the instructions for Windows 2000.

- A. Click **Start** and **Control Panel**.
- B. Click the **Network and Internet Connections** icon and then the **Network Connections** icon.
- C. Right-click the **Local Area Connection** that is associated with the Ethernet adapter you are using, and select the **Properties** option.
- D. In the *This connection uses the following items* box, highlight **Internet Protocol (TCP/IP)**. Click the **Properties** button.
- E. Enter a unique IP address that is not used by any other computer on the network connected to the Router. You can only use an IP address in the ranges 192.168.15.2 to 192.168.15.99 and 192.168.15.151 to 192.168.15.254.
- F. Enter the Subnet Mask, **255.255.255.0**.
- G. Enter the Default Gateway, **192.168.15.1** (Router's default IP address).
- H. Toward the bottom of the window, select **Use the following DNS server addresses**, and enter the Preferred DNS server and Alternative DNS server (provided by your ISP). Contact your ISP or go on its website to find the information.
- I. Click the **OK** button in the *Internet Protocol (TCP/IP) Properties* window. Click the **OK** button in the *Local Area Connection Properties* window.

**6. I want to test my Internet connection.**

- A. Check your TCP/IP settings.

**For Windows 98 and Millennium:**

Refer to Windows Help for details. Make sure **Obtain IP address automatically** is selected in the settings.

**For Windows 2000:**

1. Click **Start**, **Settings**, and **Control Panel**. Double-click **Network and Dial-Up Connections**.
2. Right-click the **Local Area Connection** that is associated with the Ethernet adapter you are using, and select the **Properties** option.
3. In the *Components checked are used by this connection* box, highlight **Internet Protocol (TCP/IP)**, and click the **Properties** button. Make sure that **Obtain an IP address automatically** and **Obtain DNS server address automatically** are selected.
4. Click the **OK** button in the *Internet Protocol (TCP/IP) Properties* window, and click the **OK** button in the *Local Area Connection Properties* window.
5. Restart the computer if asked.
6. Click the **OK** button in the *Internet Protocol (TCP/IP) Properties* window, and click the **OK** button in the *Local Area Connection Properties* window.
7. Restart the computer if asked.

**For Windows XP:**

The following instructions assume you are running Windows XP with the default interface. If you are using the Classic interface (where the icons and menus look like previous Windows versions), please follow the instructions for Windows 2000.

1. Click **Start** and **Control Panel**.
2. Click the **Network and Internet Connections** icon and then the **Network Connections** icon.
3. Right-click the **Local Area Connection** that is associated with the Ethernet adapter you are using, and select the **Properties** option.
4. In the *This connection uses the following items* box, highlight **Internet Protocol (TCP/IP)**, and click the **Properties** button. Make sure that **Obtain an IP address automatically** and **Obtain DNS server address automatically** are selected.

- B. Open a command prompt.
    - For Windows 98 and Millennium, click **Start and Run**. In the *Open* field, type **command**. Press the **Enter** key or click the **OK** button.
    - For Windows 2000 and XP, click **Start and Run**. In the *Open* field, type **cmd**. Press the **Enter** key or click the **OK** button.
  
  - C. In the command prompt, type **ping 192.168.15.1** and press the **Enter** key.
    - If you get a reply, the computer is communicating with the Router.
    - If you do NOT get a reply, check the cable, and make sure **Obtain an IP address automatically** is selected in the TCP/IP settings for your Ethernet adapter.
  
  - D. In the command prompt, type **ping** followed by your Internet IP address and press the **Enter** key. The Internet IP Address can be found in the web interface of the Router. For example, if your Internet IP address is 1.2.3.4, you would enter **ping 1.2.3.4** and press the **Enter** key.
    - If you get a reply, the computer is connected to the Router.
    - If you do NOT get a reply, try the ping command from a different computer to verify that your original computer is not the cause of the problem.
  
  - E. In the command prompt, type **ping www.linksys.com** and press the **Enter** key.
    - If you get a reply, the computer is connected to the Internet. If you cannot open a webpage, try the ping command from a different computer to verify that your original computer is not the cause of the problem.
    - If you do NOT get a reply, there may be a problem with the connection. Try the ping command from a different computer to verify that your original computer is not the cause of the problem.
- 7. I am not getting an IP address on the Internet with my Internet connection.**
- A. Refer to "Problem #6, I want to test my Internet connection" to verify that you have connectivity.
  - B. If you need to register the MAC address of your Ethernet adapter with your ISP, please see "Appendix D: Finding the MAC Address and IP Address for Your Ethernet Adapter." If you need to clone the MAC address of your Ethernet adapter onto the Router, see the MAC Address Clone section of "Chapter 5: Configuring the Router" for details.
  - C. Make sure you are using the right Internet settings. Contact your ISP to see if your Internet connection type is DHCP, Static IP Address, or PPPoE (commonly used by DSL consumers). Please refer to the Basic Setup section of "Chapter 5: Configuring the Router" for details on Internet Connection Type settings.
  - D. Make sure you use the right cable. Check to see if the Internet LED is solidly lit.
  - E. Make sure the cable connecting from your cable or DSL modem is connected to the Router's Internet port. Verify that the Status page of the Router's Web-based Utility shows a valid IP address from your ISP.
  - F. Turn off the computer, Router, and cable/DSL modem. Wait 30 seconds, and then turn on the Router, cable/DSL modem, and computer. Check the Status tab of the Router's Web-based Utility to see if you get an IP address.

**8. I am not able to access the Router's Web-based Utility Setup page.**

- A. Refer to "Problem #6, I want to test my Internet connection" to verify that your computer is properly connected to the Router.
- B. Refer to "Appendix D: Finding the MAC Address and IP Address for Your Ethernet Adapter" to verify that your computer has an IP Address, Subnet Mask, Gateway, and DNS.
- C. Set a static IP address on your system; refer to "Problem #5: I need to set a static IP address on a PC."
- D. Refer to "Problem #14: I am a PPPoE user, and I need to remove the proxy settings or the dial-up pop-up window."

**9. I can't get my Virtual Private Network (VPN) to work through the Router.**

Access the Router's web interface by going to <http://192.168.15.1> or the IP address of the Router, and go to the **Security => VPN** tab. Make sure you have IPsec passthrough and/or PPTP passthrough enabled.

VPNs that use IPsec with the ESP (Encapsulation Security Payload known as protocol 50) authentication will work fine. At least one IPsec session will work through the Router; however, simultaneous IPsec sessions may be possible, depending on the specifics of your VPNs.

VPNs that use IPsec and AH (Authentication Header known as protocol 51) are incompatible with the Router. AH has limitations due to occasional incompatibility with the NAT standard.

Change the IP address for the Router to another subnet to avoid a conflict between the VPN IP address and your local IP address. For example, if your VPN server assigns an IP address 192.168.15.X (X is a number from 1 to 254) and your local LAN IP address is 192.168.15.X (X is the same number used in the VPN IP address), the Router will have difficulties routing information to the right location. If you change the Router's IP address to 192.168.2.1, that should solve the problem. Change the Router's IP address through the Basic Setup tab of the Web-based Utility. If you assigned a static IP address to any computer or network device on the network, you need to change its IP address accordingly to 192.168.2.Y (Y being any number from 1 to 254). Note that each IP address must be unique within the network.

Your VPN may require port 500/UDP packets to be passed to the computer that is connecting to the IPsec server. Refer to "Problem #11, I need to set up online game hosting or use other Internet applications" for details. Check the Linksys website at [www.linksys.com](http://www.linksys.com) for more information.

**10. I need to set up a server behind my Router.**

To use a server like a web, ftp, or mail server, you need to know the respective port numbers they are using. For example, port 80 (HTTP) is used for web; port 21 (FTP) is used for FTP, and port 25 (SMTP outgoing) and port 110 (POP3 incoming) are used for the mail server. You can get more information by viewing the documentation provided with the server you installed. Follow these steps to set up port forwarding through the Router's Web-based Utility. We will be setting up web, ftp, and mail servers.



- A. Access the Router's Web-based Utility by going to **http://192.168.15.1** or the IP address of the Router. Go to the **Applications & Gaming => Port Range Forward** tab.
- B. Enter any name you want to use for the Application.
- C. Enter the port range of the service you are using. For example, if you have a web server, you would enter the range 80 to 80.
- D. Select the protocol you will be using, **TCP** or **UDP**, or select **Both**.
- E. Enter the IP address of the PC or network device that you want the port server to go to. For example, if the web server's Ethernet adapter IP address is 192.168.15.100, you would enter 100 in the field provided. Check "Appendix D: Finding the MAC Address and IP Address for Your Ethernet Adapter" for details on getting an IP address.
- F. Check the **Enable** option for the port services you want to use. Consider the examples below:

Application	Start and End	Protocol	IP Address	Enable
Web server	80 to 80	Both	192.168.15.100	X
FTP server	21 to 21	TCP	192.168.15.101	X
SMTP (outgoing)	25 to 25	Both	192.168.15.102	X
POP3 (incoming)	110 to 110	Both	192.168.15.102	X

When you have completed the configuration, click the **Save Settings** button.

#### **11. I need to set up online game hosting or use other Internet applications.**

If you want to play online games or use Internet applications, most will work without doing any port forwarding or DMZ hosting. There may be cases when you want to host an online game or Internet application. This would require you to set up the Router to deliver incoming packets or data to a specific computer. This also applies to the Internet applications you are using. The best way to get the information on what port services to use is to go to the website of the online game or application you want to use. Follow these steps to set up online game hosting or use a certain Internet application:

- A. Access the Router's Web-based Utility by going to **http://192.168.15.1** or the IP address of the Router. Go to the **Applications & Gaming => Port Range Forward** tab.
- B. Enter any name you want to use for the Application.
- C. Enter the port range of the service you are using. For example, if you have a web server, you would enter the range 80 to 80.
- D. Select the protocol you will be using, **TCP** or **UDP**, or select **Both**.
- E. Enter the IP address of the PC or network device that you want the port server to go to. For example, if the web server's Ethernet adapter IP address is 192.168.15.100, you would enter 100 in the field provided.

Check “Appendix D: Finding the MAC Address and IP Address for Your Ethernet Adapter” for details on getting an IP address.

- F. Check the **Enable** option for the port services you want to use. Consider the examples below:

Application	Start and End	Protocol	IP Address	Enable
UT	7777 to 27900	Both	192.168.15.100	X
Halflife	27015 to 27015	Both	192.168.15.105	X
PC Anywhere	5631 to 5631	UDP	192.168.15.102	X
VPN IPSEC	500 to 500	UDP	192.168.15.100	X

When you have completed the configuration, click the **Save Settings** button.

### **12. I can't get the Internet game, server, or application to work.**

If you are having difficulties getting any Internet game, server, or application to function properly, consider exposing one PC to the Internet using DeMilitarized Zone (DMZ) hosting. This option is available when an application requires too many ports or when you are not sure which port services to use. Make sure you disable all the forwarding entries if you want to successfully use DMZ hosting, since forwarding has priority over DMZ hosting. (In other words, data that enters the Router will be checked first by the forwarding settings. If the port number that the data enters from does not have port forwarding, then the Router will send the data to whichever PC or network device you set for DMZ hosting.) Follow these steps to set DMZ hosting:

- Access the Router's Web-based Utility by going to **http://192.168.15.1** or the IP address of the Router. Go to the **Applications & Gaming => Port Range Forward** tab.
- Disable or remove the entries you have entered for forwarding. Keep this information in case you want to use it at a later time.
- Click the **DMZ** tab.
- Enter the Ethernet adapter's IP address of the computer you want exposed to the Internet. This will bypass the NAT security for that computer. Please refer to “Appendix D: Finding the MAC Address and IP Address for Your Ethernet Adapter” for details on getting an IP address.

Once completed with the configuration, click the **Save Settings** button.

### **13. I forgot my password, or the password prompt always appears when saving settings to the Router.**

Reset the Router to factory default by pressing the Reset button for 30 seconds and then releasing it. If you are still getting prompted for a password when saving settings, then perform the following steps:

- A. Access the Router's web interface by going to **http://192.168.15.1** or the IP address of the Router. Enter the default password **admin**, and click the **Administration => Management** tab.
- B. Enter a different password in the *Router Password* field, and enter the same password in the second field to confirm the password.
- C. Click the **Save Settings** button.

**14. I am a PPPoE user, and I need to remove the proxy settings or the dial-up pop-up window.**

If you have proxy settings, you need to disable these on your computer. Because the Router is the gateway for the Internet connection, the computer does not need any proxy settings to gain access. Please follow these directions to verify that you do not have any proxy settings and that the browser you use is set to connect directly to the LAN.

For Microsoft Internet Explorer 5.0 or higher:

- A. Click **Start, Settings, and Control Panel**. Double-click **Internet Options**.
- B. Click the **Connections** tab.
- C. Click the **LAN settings** button and remove anything that is checked.
- D. Click the **OK** button to go back to the previous screen.
- E. Click the option **Never dial a connection**. This will remove any dial-up pop-ups for PPPoE users.

For Netscape 4.7 or higher:

- A. Start **Netscape Navigator**, and click **Edit, Preferences, Advanced, and Proxies**.
- B. Make sure you have **Direct connection to the Internet** selected on this screen.
- C. Close all the windows to finish.

**15. To start over, I need to set the Router to factory default.**

Hold the Reset button for up to 30 seconds and then release it. This will return the password, forwarding, and other settings on the Router to the factory default settings. In other words, the Router will revert to its original factory configuration.

**16. My DSL service's PPPoE is always disconnecting.**

PPPoE is not actually a dedicated or always-on connection. The DSL ISP can disconnect the service after a period of inactivity, just like a normal phone dial-up connection to the Internet. There is a setup option to "keep alive" the connection. This may not always work, so you may need to re-establish connection periodically.

- A. To connect to the Router, go to the web browser, and enter **http://192.168.15.1** or the IP address of the Router.
- B. Enter the password, if asked. (The default password is admin.)
- C. On the *Basic Setup* tab, select the option **Keep Alive**, and set the *Redial Period* option at **20** (seconds).

- D. Click the **Save Settings** button.
- E. Click the **Status** tab, and click the **Connect** button.
- F. You may see the login status display as Connecting. Press the **F5** key to refresh the screen, until you see the login status display as Connected.

If the connection is lost again, follow steps E and F to re-establish connection.

**17. I can't access my email, web, or VPN, or I am getting corrupted data from the Internet.**

The Maximum Transmission Unit (MTU) setting may need to be adjusted. By default, the MTU is set at 1500. For most DSL users, it is strongly recommended to use MTU 1492. If you are having some difficulties, perform the following steps:

- A. Open the web browser, and enter **http://192.168.15.1** or the IP address of the Router.
- B. Enter the password, if asked. (The default password is **admin**.)
- C. On the *Basic Setup* tab, look for the MTU option, and select **Manual**. In the *Size* field, enter 1492.
- D. Click the **Save Settings** button to continue.

If your difficulties continue, change the Size to different values. Try this list of values, one value at a time, in this order, until your problem is solved:

1462  
1400  
1362  
1300

**18. I need to use port triggering.**

Port triggering looks at the outgoing port services used and will trigger the Router to open a specific port, depending on which port an Internet application uses. Follow these steps:

- A. To connect to the Router, go to the web browser, and enter **http://192.168.15.1** or the IP address of the Router.
- B. Enter the password, if asked. (The default password is **admin**.)
- C. Click the **Applications & Gaming => Port Trigger** tab.
- D. Enter any name you want to use for the Application Name.
- E. Enter the Start and End Ports of the Triggered Port Range. Check with your Internet application provider for more information on which outgoing port services it is using.
- F. Enter the Start and End Ports of the Forwarded Port Range. Check with your Internet application provider for more information on which incoming port services are required by the Internet application.
- G. Check the **Enable** option for the port services you want to use.

When you have completed the configuration, click the **Save Settings** button.

**19. When I enter a URL or IP address, I get a time-out error or am prompted to retry.**

Go through this checklist until your problem is solved:

- Check if other PCs work. If they do, ensure that your workstation's IP settings are correct (IP Address, Subnet Mask, Default Gateway, and DNS). Restart the computer that is having a problem.
- If the PCs are configured correctly, but still not working, check the Router. Ensure that it is connected and powered on. Connect to it and check its settings. (If you cannot connect to it, check the LAN and power connections.)
- If the Router is configured correctly, check your Internet connection (DSL/cable modem, etc.) to see if it is working correctly. You can remove the Router to verify a direct connection.
- Manually configure the TCP/IP with a DNS address provided by your ISP.
- Make sure that your browser is set to connect directly and that any dial-up is disabled. For Internet Explorer, click **Tools, Internet Options**, and then the **Connection** tab. Make sure that Internet Explorer is set to **Never dial a connection**. For Netscape Navigator, click **Edit, Preferences, Advanced**, and **Proxy**. Make sure that Netscape Navigator is set to **Direct connection to the Internet**.

## Frequently Asked Questions

***How do I configure the Router for Internet phone service?***

Run the Setup Wizard or follow the instructions of the Quick Installation or User Guide to install and configure the Router for your type of Internet connection. To configure the Router for Internet phone service, visit <https://www.att.com/linksys> and sign up for or activate your account.

***How do I make a phone call?***

Pick up your phone and dial 1 + area code + phone number. You must dial 1 and the area code for all calls, even local ones.

***Can I make calls if my Internet connection is down?***

No. Your high-speed Internet connection must be active when you make Internet phone or fax calls.

***Can I make calls while I'm browsing the Internet?***

Yes. You can make Internet phone or fax calls while browsing the Internet. However, your web browsing may affect the quality of your telephone call, depending on the amount of upstream data traffic passing through your Internet connection.

***How do I change the features of my Internet phone service account?***

For features such as call-waiting or call-forwarding, go to <https://www.callvantage.att.com/> and access your account online.

***What is the maximum number of IP addresses that the Router will support?***

The Router will support up to 253 IP addresses.

***Is IPSec Passthrough supported by the Router?***

Yes, enable or disable IPSec Passthrough on the Security => VPN Passthrough tab.

***Where is the Router installed on the network?***

In a typical environment, the Router is installed between the cable/DSL modem and the local area network (LAN). Plug the Router into the cable/DSL modem's Ethernet port.

***Does the Router support IPX or AppleTalk?***

No. TCP/IP is the only protocol standard for the Internet and has become the global standard for communications. IPX, a NetWare communications protocol used only to route messages from one node to another, and AppleTalk, a communications protocol used on Apple and Macintosh networks, can be used for LAN to LAN connections, but those protocols cannot connect from the Internet to the LAN.

***What is Network Address Translation and what is it used for?***

Network Address Translation (NAT) translates multiple IP addresses on the private LAN to one public address that is sent out to the Internet. This adds a level of security since the address of a PC connected to the private LAN is never transmitted on the Internet. Furthermore, NAT allows the Router to be used with low cost Internet accounts, such as DSL or cable modems, when only one TCP/IP address is provided by the ISP. The user may have many private addresses behind this single address provided by the ISP.

***Does the Router support any operating system other than Windows 98, Millennium, 2000, or XP?***

Yes, but Linksys does not, at this time, provide technical support for setup, configuration or troubleshooting of any non-Windows operating systems.

***Does the Router support ICQ send file?***

Yes, with the following fix: click **ICQ menu** => **preference** => **connections** tab=>, and check **I am behind a firewall or proxy**. Then set the firewall time-out to 80 seconds in the firewall setting. The Internet user can then send a file to a user behind the Router.

***I set up an Unreal Tournament Server, but others on the LAN cannot join. What do I need to do?***

If you have a dedicated Unreal Tournament server running, you need to create a static IP for each of the LAN computers and forward ports 7777, 7778, 7779, 7780, 7781, and 27900 to the IP address of the server. You can also use a port forwarding range of 7777 to 27900. If you want to use the UT Server Admin, forward another port (8080 usually works well but is used for remote admin. You may have to disable this.), and then in the [UWeb.WebServer] section of the server.ini file, set the ListenPort to 8080 (to match the mapped port above) and ServerName to the IP assigned to the Router from your ISP.

***Can multiple gamers on the LAN get on one game server and play simultaneously with just one public IP address?***

It depends on which network game or what kind of game server you are using. For example, Unreal Tournament supports multi-login with one public IP.

***How do I get Half-Life: Team Fortress to work with the Router?***

The default client port for Half-Life is 27005. The computers on your LAN need to have "+clientport 2700x" added to the HL shortcut command line; the x would be 6, 7, 8, and on up. This lets multiple computers connect to the same server. One problem: Version 1.0.1.6 won't let multiple computers with the same CD key connect at the same time, even if on the same LAN (not a problem with 1.0.1.3). As far as hosting games, the HL server does not need to be in the DMZ. Just forward port 27015 to the local IP address of the server computer.

***How can I block corrupted FTP downloads?***

If you are experiencing corrupted files when you download a file with your FTP client, try using another FTP program.

***The web page hangs; downloads are corrupt, or nothing but junk characters are being displayed on the screen. What do I need to do?***

Force your Ethernet adapter to 10Mbps or half duplex mode, and turn off the "Auto-negotiate" feature of your Ethernet adapter as a temporary measure. (Please look at the Network Control Panel in your Ethernet adapter's Advanced Properties tab.) Make sure that your proxy setting is disabled in the browser. Check our website at [www.linksys.com](http://www.linksys.com) for more information.

***If all else fails in the installation, what can I do?***

Reset the Router by holding down the Reset button for thirty seconds. Then reset your cable or DSL modem by powering the unit off and then on.

***Will the Router function in a Macintosh environment?***

Yes, but the Router's setup pages are accessible only through Internet Explorer 5.0 or Netscape Navigator 5.0 or higher for Macintosh.

***I am not able to get the web configuration screen for the Router. What can I do?***

You may have to remove the proxy settings on your Internet browser, e.g., Netscape Navigator or Internet Explorer. Or remove the dial-up settings on your browser. Check with your browser documentation, and make sure that your browser is set to connect directly and that any dial-up is disabled. Make sure that your browser is set to connect directly and that any dial-up is disabled. For Internet Explorer, click **Tools, Internet Options**, and then the **Connection** tab. Make sure that Internet Explorer is set to **Never dial a connection**. For Netscape Navigator, click **Edit, Preferences, Advanced**, and **Proxy**. Make sure that Netscape Navigator is set to **Direct connection to the Internet**.

***What is DMZ Hosting?***

Demilitarized Zone (DMZ) allows one IP address (computer) to be exposed to the Internet. Some applications require multiple TCP/IP ports to be open. It is recommended that you set your computer with a static IP if you want to use DMZ Hosting. To get the LAN IP address, see "Appendix D: Finding the MAC Address and IP Address for Your Ethernet Adapter."

***If DMZ Hosting is used, does the exposed user share the public IP with the Router?***

No.

***Does the Router pass PPTP packets or actively route PPTP sessions?***

The Router allows PPTP packets to pass through.

***Is the Router cross-platform compatible?***

Any platform that supports Ethernet and TCP/IP is compatible with the Router.

***How many ports can be simultaneously forwarded?***

Theoretically, the Router can establish 520 sessions at the same time, but you can only forward 10 ranges of ports.

***Does the Router replace a modem? Is there a cable or DSL modem in the Router?***

No, this version of the Router must work in conjunction with a cable or DSL modem.

***Which modems are compatible with the Router?***

The Router is compatible with virtually any cable or DSL modem that supports Ethernet.

***What is the maximum number of VPN sessions allowed by the Router?***

The maximum number depends on many factors. At least one IPSec session will work through the Router; however, simultaneous IPSec sessions may be possible, depending on the specifics of your VPNs.

***How can I check whether I have static or DHCP IP addresses?***

Ask your ISP to find out.

***How do I get mIRC to work with the Router?***

Under the Applications & Gaming => Port Range Forward tab, set port forwarding to 113 for the PC on which you are using mIRC.

***What is the IEEE 802.11b standard?***

It is one of the IEEE standards for wireless networks. The 802.11b standard allows wireless networking hardware from different manufacturers to communicate, provided that the hardware complies with the 802.11b standard. The 802.11b standard states a maximum data transfer rate of 11Mbps and an operating frequency of 2.4GHz.



***What is the IEEE 802.11g standard?***

It is one of the IEEE standards for wireless networks. The 802.11g standard allows wireless networking hardware from different manufacturers to communicate, provided that the hardware complies with the 802.11g standard. The 802.11g standard states a maximum data transfer rate of 54Mbps and an operating frequency of 2.4GHz.

***What IEEE 802.11b features are supported?***

The product supports the following IEEE 802.11b functions:

- CSMA/CA plus Acknowledge protocol
- Multi-Channel Roaming
- Automatic Rate Selection
- RTS/CTS feature
- Fragmentation
- Power Management

***What IEEE 802.11g features are supported?***

The product supports the following IEEE 802.11g functions:

- CSMA/CA plus Acknowledge protocol
- OFDM protocol
- Multi-Channel Roaming
- Automatic Rate Selection
- RTS/CTS feature
- Fragmentation
- Power Management

***What is ad-hoc mode?***

When a wireless network is set to ad-hoc mode, the wireless-equipped computers are configured to communicate directly with each other. The ad-hoc wireless network will not communicate with any wired network.

***What is infrastructure mode?***

When a wireless network is set to infrastructure mode, the wireless network is configured to communicate with a wired network through a wireless access point.

***What is roaming?***

Roaming is the ability of a portable computer user to communicate continuously while moving freely throughout an area greater than that covered by a single access point. Before using the roaming function, the workstation must make sure that it is the same channel number with the access point of dedicated coverage area.

To achieve true seamless connectivity, the wireless LAN must incorporate a number of different functions. Each node and access point, for example, must always acknowledge receipt of each message. Each node must

maintain contact with the wireless network even when not actually transmitting data. Achieving these functions simultaneously requires a dynamic RF networking technology that links access points and nodes. In such a system, the user's end node undertakes a search for the best possible access to the system. First, it evaluates such factors as signal strength and quality, as well as the message load currently being carried by each access point and the distance of each access point to the wired backbone. Based on that information, the node next selects the right access point and registers its address. Communications between end node and host computer can then be transmitted up and down the backbone.

As the user moves on, the end node's RF transmitter regularly checks the system to determine whether it is in touch with the original access point or whether it should seek a new one. When a node no longer receives acknowledgment from its original access point, it undertakes a new search. Upon finding a new access point, it then re-registers, and the communication process continues.

### ***What is ISM band?***

The FCC and their counterparts outside of the U.S. have set aside bandwidth for unlicensed use in the ISM (Industrial, Scientific and Medical) band. Spectrum in the vicinity of 2.4 GHz, in particular, is being made available worldwide. This presents a truly revolutionary opportunity to place convenient high-speed wireless capabilities in the hands of users around the globe.

### ***What is Spread Spectrum?***

Spread Spectrum technology is a wideband radio frequency technique developed by the military for use in reliable, secure, mission-critical communications systems. It is designed to trade off bandwidth efficiency for reliability, integrity, and security. In other words, more bandwidth is consumed than in the case of narrowband transmission, but the trade-off produces a signal that is, in effect, louder and thus easier to detect, provided that the receiver knows the parameters of the spread-spectrum signal being broadcast. If a receiver is not tuned to the right frequency, a spread-spectrum signal looks like background noise. There are two main alternatives, Direct Sequence Spread Spectrum (DSSS) and Frequency Hopping Spread Spectrum (FHSS).

### ***What is DSSS? What is FHSS? And what are their differences?***

Frequency-Hopping Spread-Spectrum (FHSS) uses a narrowband carrier that changes frequency in a pattern that is known to both transmitter and receiver. Properly synchronized, the net effect is to maintain a single logical channel. To an unintended receiver, FHSS appears to be short-duration impulse noise. Direct-Sequence Spread-Spectrum (DSSS) generates a redundant bit pattern for each bit to be transmitted. This bit pattern is called a chip (or chipping code). The longer the chip, the greater the probability that the original data can be recovered. Even if one or more bits in the chip are damaged during transmission, statistical techniques embedded in the radio can recover the original data without the need for retransmission. To an unintended receiver, DSSS appears as low power wideband noise and is rejected (ignored) by most narrowband receivers.

***What is WEP?***

WEP is Wired Equivalent Privacy, a data privacy mechanism based on a shared key algorithm, as described in the IEEE 802.11 standard.

***What is WPA?***

WPA is Wi-Fi Protected Access, a wireless security protocol that can be used in conjunction with a RADIUS server.

***What is a MAC Address?***

The Media Access Control (MAC) address is a unique number assigned by the manufacturer to any Ethernet networking device, such as a network adapter, that allows the network to identify it at the hardware level. For all practical purposes, this number is usually permanent. Unlike IP addresses, which can change every time a computer logs onto the network, the MAC address of a device stays the same, making it a valuable identifier for the network.

***How do I reset the Router?***

Press the Reset button on the back panel for about five seconds. This will reset the Router to its default settings.

***How do I resolve issues with signal loss?***

There is no way to know the exact range of your wireless network without testing. Every obstacle placed between the Router and a wireless PC will create signal loss. Lead glass, metal, concrete floors, water and walls will inhibit the signal and reduce range. Start with the Router and your wireless PC in the same room and move it away in small increments to determine the maximum range in your environment.

You may also try using different channels, as this may eliminate interference affecting only one channel.

**If your questions are not addressed here, refer to  
the AT&T website, <http://www.usa.att.com/callvantage/faqs/index.jsp>,  
or the Linksys website, [www.linksys.com](http://www.linksys.com).**

# Appendix B: Wireless Security

Linksys wants to make wireless networking as safe and easy for you as possible. The current generation of Linksys products provide several network security features, but they require specific action on your part for implementation. So, keep the following in mind whenever you are setting up or using your wireless network.

## Security Precautions

The following is a complete list of security precautions to take (at least steps 1 through 5 should be followed):

1. Change the default SSID.
2. Disable SSID Broadcast.
3. Change the default password for the Administrator account.
4. Enable MAC Address Filtering.
5. Change the SSID periodically.
6. Use the highest encryption algorithm possible. Use WPA if it is available. Please note that this may reduce your network performance.
7. Change the WEP encryption keys periodically.

For information on implementing these security features, refer to "Chapter 5: Configuring the Router."

## Security Threats Facing Wireless Networks

Wireless networks are easy to find. Hackers know that in order to join a wireless network, wireless networking products first listen for "beacon messages". These messages can be easily decrypted and contain much of the network's information, such as the network's SSID (Service Set Identifier). Here are the steps you can take:

**Change the administrator's password regularly.** With every wireless networking device you use, keep in mind that network settings (SSID, WEP keys, etc.) are stored in its firmware. Your network administrator is the only person who can change network settings. If a hacker gets a hold of the administrator's password, he, too, can change those settings. So, make it harder for a hacker to get that information. Change the administrator's password regularly.



**Note:** Some of these security features are available only through the network router or access point. Refer to the router or access point's documentation for more information.

**SSID.** There are several things to keep in mind about the SSID:

1. Disable Broadcast
2. Make it unique
3. Change it often

Most wireless networking devices will give you the option of broadcasting the SSID. While this option may be more convenient, it allows anyone to log into your wireless network. This includes hackers. So, don't broadcast the SSID.

Wireless networking products come with a default SSID set by the factory. (The Linksys default SSID is "linksys".) Hackers know these defaults and can check these against your network. Change your SSID to something unique and not something related to your company or the networking products you use.

Change your SSID regularly so that any hackers who have gained access to your wireless network will have to start from the beginning in trying to break in.

**MAC Addresses.** Enable MAC Address filtering. MAC Address filtering will allow you to provide access to only those wireless nodes with certain MAC Addresses. This makes it harder for a hacker to access your network with a random MAC Address.

**WEP Encryption.** Wired Equivalent Privacy (WEP) is often looked upon as a cure-all for wireless security concerns. This is overstating WEP's ability. Again, this can only provide enough security to make a hacker's job more difficult.

There are several ways that WEP can be maximized:

1. Use the highest level of encryption possible
2. Use "Shared Key" authentication
3. Change your WEP key regularly

**WPA.** Wi-Fi Protected Access (WPA) is the newest and best available standard in Wi-Fi security. Two modes are available: Pre-Shared Key and RADIUS. Pre-Shared Key gives you one encryption methods: TKIP (Temporal Key Integrity Protocol), which utilizes a stronger encryption method and incorporates Message Integrity Code (MIC) to provide protection against hackers.



**Important:** Always remember that each device in your wireless network **MUST** use the same encryption method and encryption key or your wireless network will not function properly.

## Wireless-G Broadband Router with 2 Phone Ports

**WPA Pre-Shared Key.** If you do not have a RADIUS server, Select the type of algorithm, TKIP or AES, enter a password in the Pre-Shared key field of 8-64 characters, and enter a Group Key Renewal period time between 0 and 99,999 seconds, which instructs the Router or other device how often it should change the encryption keys.

**WPA RADIUS.** WPA used in coordination with a RADIUS server. (This should only be used when a RADIUS server is connected to the Router or other device.) First, select the type of WPA algorithm, **TKIP** or **AES**. Enter the RADIUS server's IP Address and port number, along with a key shared between the device and the server. Last, enter a Group Key Renewal period, which instructs the device how often it should change the encryption keys.

Implementing encryption may have a negative impact on your network's performance, but if you are transmitting sensitive data over your network, encryption should be used.

These security recommendations should help keep your mind at ease while you are enjoying the most flexible and convenient technology Linksys has to offer.

# Appendix C: Windows Help

Almost all networking products require Microsoft Windows. Windows is the most used operating system in the world and comes with many features that help make networking easier. These features can be accessed through Windows Help and are described in this appendix.

## TCP/IP

Before a computer can communicate with the Router, TCP/IP must be enabled. TCP/IP is a set of instructions, or protocol, all PCs follow to communicate over a wired or wireless network. Your PCs will not be able to utilize networking without having TCP/IP enabled. Windows Help provides complete instructions on enabling TCP/IP.

## Shared Resources

If you wish to share printers, folders, or files over your network, Windows Help provides complete instructions on utilizing shared resources.

## Network Neighborhood/My Network Places

Other PCs on your network will appear under Network Neighborhood or My Network Places (depending upon the version of Windows you're running). Windows Help provides complete instructions on adding PCs to your network.

# Appendix D: Finding the MAC Address and IP Address for Your Ethernet Adapter

This section describes how to find the MAC address for your computer's Ethernet adapter so you can use the MAC filtering and/or MAC address cloning feature of the Router. You can also find the IP address of your computer's Ethernet adapter. This IP address is used for the Router's filtering, forwarding, and/or DMZ features. Follow the steps in this appendix to find the adapter's MAC or IP address in Windows 98, Me, 2000, or XP.

## Windows 98 or Me Instructions

1. Click **Start** and **Run**. In the *Open* field, enter `winipcfg`. Then press the **Enter** key or the **OK** button.
2. When the *IP Configuration* screen appears, select the Ethernet adapter you have connected to the Router via a CAT 5 Ethernet network cable.
3. Write down the Adapter Address as shown on your computer screen. This is the MAC address for your Ethernet adapter and is shown as a series of numbers and letters.

The MAC address/Adapter Address is what you will use for MAC address cloning or MAC filtering.

The example shows the Ethernet adapter's IP address as 192.168.1.100. Your computer may show something different.



**Note:** The MAC address is also called the Adapter Address.

## Windows 2000 or XP Instructions

1. Click **Start** and **Run**. In the *Open* field, enter `cmd`. Press the **Enter** key or click the **OK** button.
2. At the command prompt, enter `ipconfig /all`. Then press the **Enter** key.

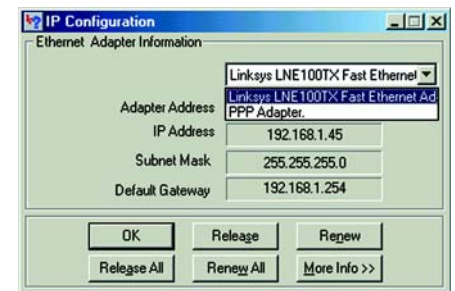

Figure D-1: IP Configuration Screen

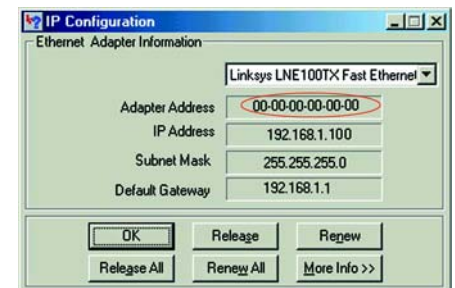

Figure D-2: MAC Address/Adapter Address



- Write down the Physical Address as shown on your computer screen; it is the MAC address for your Ethernet adapter. This appears as a series of numbers and letters.

The MAC address/Physical Address is what you will use for MAC address cloning or MAC filtering.



**Note:** The MAC address is also called the Physical Address.

The example shows the Ethernet adapter's IP address as 192.168.1.100. Your computer may show something different.

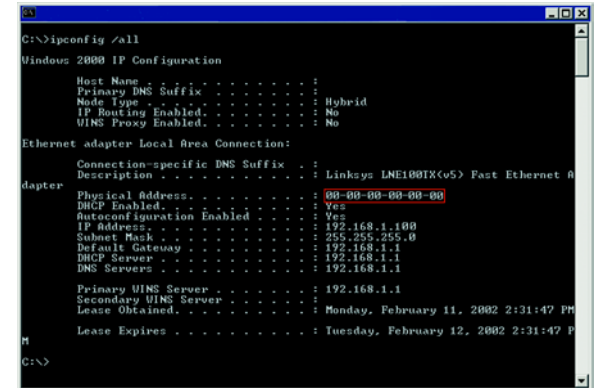

Figure D-3: MAC Address/Physical Address

## For the Router's Web-based Utility

You can use MAC or IP addresses to designate computers for each Internet Access Policy you create. To specify a computer, enter its IP address or 12-digit MAC address.

For MAC address cloning, enter the 12-digit MAC address in the *User Defined Entry* fields, two digits per field.

For more details, refer to "Chapter 5: Configuring the Router."

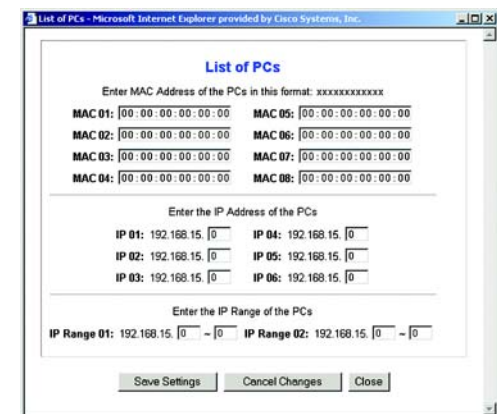

Figure D-4: Access Restrictions - MAC and IP Addresses



Figure D-5: MAC Address Clone

# Appendix E: Glossary

**802.11b** - A wireless networking standard that specifies a maximum data transfer rate of 11Mbps and an operating frequency of 2.4GHz.

**802.11g** - A wireless networking standard that specifies a maximum data transfer rate of 54Mbps, an operating frequency of 2.4GHz, and backward compatibility with 802.11b devices.

**Access Point** - A device that allows wireless-equipped computers and other devices to communicate with a wired network. Also used to expand the range of a wireless network.

**Adapter** - A device that adds network functionality to your PC.

**Ad-hoc** - A group of wireless devices communicating directly with each other (peer-to-peer) without the use of an access point.

**AES (Advanced Encryption Standard)** - A security method that uses symmetric 128-bit block data encryption.

**Backbone** - The part of a network that connects most of the systems and networks together, and handles the most data.

**Bandwidth** - The transmission capacity of a given device or network.

**Beacon Interval** - Data transmitted on your wireless network that keeps the network synchronized.

**Bit** - A binary digit.

**Boot** - To start a device and cause it to start executing instructions.

**Bridge** - A device that connects different networks.

**Broadband** - An always-on, fast Internet connection.

**Browser** - An application program that provides a way to look at and interact with all the information on the World Wide Web.

**Buffer** - A shared or assigned memory area that is used to support and coordinate different computing and networking activities so one isn't held up by the other.

**Byte** - A unit of data that is usually eight bits long

**Cable Modem** - A device that connects a computer to the cable television network, which in turn connects to the Internet.

**CSMA/CA (Carrier Sense Multiple Access/Collision Avoidance)** - A method of data transfer that is used to prevent data collisions.

**CTS (Clear To Send)** - A signal sent by a wireless device, signifying that it is ready to receive data.

**Daisy Chain** - A method used to connect devices in a series, one after the other.

**Database** - A collection of data that is organized so that its contents can easily be accessed, managed, and updated.

**DDNS (Dynamic Domain Name System)** - Allows the hosting of a website, FTP server, or e-mail server with a fixed domain name (e.g., www.xyz.com) and a dynamic IP address.

**Default Gateway** - A device that forwards Internet traffic from your local area network.

**DHCP (Dynamic Host Configuration Protocol)** - A networking protocol that allows administrators to assign temporary IP addresses to network computers by "leasing" an IP address to a user for a limited amount of time, instead of assigning permanent IP addresses.

**DMZ (Demilitarized Zone)** - Removes the Router's firewall protection from one PC, allowing it to be "seen" from the Internet.

**DNS (Domain Name Server)** - The IP address of your ISP's server, which translates the names of websites into IP addresses.

**Domain** - A specific name for a network of computers.

**Download** - To receive a file transmitted over a network.

**DSL (Digital Subscriber Line)** - An always-on broadband connection over traditional phone lines.

**DSSS (Direct-Sequence Spread-Spectrum)** - Frequency transmission with a redundant bit pattern resulting in a lower probability of information being lost in transit.

**DTIM (Delivery Traffic Indication Message)** - A message included in data packets that can increase wireless efficiency.

**Dynamic IP Address** - A temporary IP address assigned by a DHCP server.

**EAP (Extensible Authentication Protocol)** - A general authentication protocol used to control network access. Many specific authentication methods work within this framework.

**EAP-PEAP (Extensible Authentication Protocol-Protected Extensible Authentication Protocol)** - A mutual authentication method that uses a combination of digital certificates and another system, such as passwords.

**EAP-TLS (Extensible Authentication Protocol-Transport Layer Security)** - A mutual authentication method that uses digital certificates.

**Encryption** - Encoding data transmitted in a network.

**Ethernet** - A networking protocol that specifies how data is placed on and retrieved from a common transmission medium.

**Finger** - A program that tells you the name associated with an e-mail address.

**Firewall** - A set of related programs located at a network gateway server that protects the resources of a network from users from other networks.

**Firmware** - The programming code that runs a networking device.

**Fragmentation** - Breaking a packet into smaller units when transmitting over a network medium that cannot support the original size of the packet.

**FTP (File Transfer Protocol)** - A protocol used to transfer files over a TCP/IP network.

**Full Duplex** - The ability of a networking device to receive and transmit data simultaneously.

**Gateway** - A device that interconnects networks with different, incompatible communications protocols.

**Half Duplex** - Data transmission that can occur in two directions over a single line, but only one direction at a time.

**Hardware** - The physical aspect of computers, telecommunications, and other information technology devices.

**HTTP (HyperText Transport Protocol)** - The communications protocol used to connect to servers on the World Wide Web.

**Infrastructure** - A wireless network that is bridged to a wired network via an access point.

**IP (Internet Protocol)** - A protocol used to send data over a network.

**IP Address** - The address used to identify a computer or device on a network.

## Wireless-G Broadband Router with 2 Phone Ports

**IPCONFIG** - A Windows 2000 and XP utility that displays the IP address for a particular networking device.

**IPSec (Internet Protocol Security)** - A VPN protocol used to implement secure exchange of packets at the IP layer.

**ISM band** - Radio bandwidth utilized in wireless transmissions.

**ISP (Internet Service Provider)** - A company that provides access to the Internet.

**LAN** - The computers and networking products that make up your local network.

**LEAP (Lightweight Extensible Authentication Protocol)** - A mutual authentication method that uses a username and password system.

**MAC (Media Access Control) Address** - The unique address that a manufacturer assigns to each networking device.

**Mbps (MegaBits Per Second)** - One million bits per second; a unit of measurement for data transmission.

**mIRC** - An Internet Relay Chat program that runs under Windows.

**Multicasting** - Sending data to a group of destinations at once.

**NAT (Network Address Translation)** - NAT technology translates IP addresses of a local area network to a different IP address for the Internet.

**NAT (Network Address Translation) Traversal** -A method of enabling specialized applications, such as Internet phone calls, video, and audio, to travel between your local network and the Internet. STUN is a specific type of NAT traversal.

**Network** - A series of computers or devices connected for the purpose of data sharing, storage, and/or transmission between users.

**NNTP (Network News Transfer Protocol)** - The protocol used to connect to Usenet groups on the Internet.

**Node** - A network junction or connection point, typically a computer or work station.

**OFDM (Orthogonal Frequency Division Multiplexing)** - Frequency transmission that separates the data stream into a number of lower-speed data streams, which are then transmitted in parallel to prevent information from being lost in transit.

**Packet** - A unit of data sent over a network.

**Passphrase** - Used much like a password, a passphrase simplifies the WEP encryption process by automatically generating the WEP encryption keys for Linksys products.

**Ping (Packet INternet Groper)** - An Internet utility used to determine whether a particular IP address is online.

**POP3 (Post Office Protocol 3)** - A standard mail server commonly used on the Internet.

**Port** - The connection point on a computer or networking device used for plugging in cables or adapters.

**Power over Ethernet (PoE)** - A technology enabling an Ethernet network cable to deliver both data and power.

**PPPoE (Point to Point Protocol over Ethernet)** - A type of broadband connection that provides authentication (username and password) in addition to data transport.

**PPTP (Point-to-Point Tunneling Protocol)** - A VPN protocol that allows the Point to Point Protocol (PPP) to be tunneled through an IP network. This protocol is also used as a type of broadband connection in Europe.

**Preamble** - Part of the wireless signal that synchronizes network traffic.

**RADIUS (Remote Authentication Dial-In User Service)** - A protocol that uses an authentication server to control network access.

**RJ-45 (Registered Jack-45)** - An Ethernet connector that holds up to eight wires.

**Roaming** - The ability to take a wireless device from one access point's range to another without losing the connection.

**Router** - A networking device that connects multiple networks together.

**RTP (Real-time Transport Protocol)** - A protocol that enables specialized applications, such as Internet phone calls, video, and audio, to occur in real time.

**RTS (Request To Send)** - A networking method of coordinating large packets through the RTS Threshold setting.

**Server** - Any computer whose function in a network is to provide user access to files, printing, communications, and other services.

**SMTP (Simple Mail Transfer Protocol)** - The standard e-mail protocol on the Internet.

**SNMP (Simple Network Management Protocol)** - A widely used network monitoring and control protocol.

**Software** - Instructions for the computer. A series of instructions that performs a particular task is called a "program".

**SOHO (Small Office/Home Office)** - Market segment of professionals who work at home or in small offices.

**SPI (Stateful Packet Inspection) Firewall** - A technology that inspects incoming packets of information before allowing them to enter the network.

**Spread Spectrum** - Wideband radio frequency technique used for more reliable and secure data transmission.

**SSID (Service Set Identifier)** - Your wireless network's name.

**Static IP Address** - A fixed address assigned to a computer or device that is connected to a network.

**Static Routing** - Forwarding data in a network via a fixed path.

**STUN (Simple Traversal of UDP through NATs)** - A protocol that enables specialized applications, such as Internet phone calls, video, and audio, to travel between your local network and the Internet. STUN is a specific type of NAT traversal.

**Subnet Mask** - An address code that determines the size of the network.

**Switch** - 1. A data switch that connects computing devices to host computers, allowing a large number of devices to share a limited number of ports. 2. A device for making, breaking, or changing the connections in an electrical circuit.

**TCP (Transmission Control Protocol)** - A network protocol for transmitting data that requires acknowledgement from the recipient of data sent.

**TCP/IP (Transmission Control Protocol/Internet Protocol)** - A set of instructions PCs use to communicate over a network.

**Telnet** - A user command and TCP/IP protocol used for accessing remote PCs.

**TFTP (Trivial File Transfer Protocol)** - A version of the TCP/IP FTP protocol that has no directory or password capability.

**Throughput** - The amount of data moved successfully from one node to another in a given time period.

**TKIP (Temporal Key Integrity Protocol)** - a wireless encryption protocol that provides dynamic encryption keys for each packet transmitted.

**Topology** - The physical layout of a network.

**TX Rate** - Transmission Rate.

## Wireless-G Broadband Router with 2 Phone Ports

**UDP (User Datagram Protocol)** - A network protocol for transmitting data that does not require acknowledgement from the recipient of the data that is sent.

**Upgrade** - To replace existing software or firmware with a newer version.

**Upload** - To transmit a file over a network.

**URL (Uniform Resource Locator)** - The address of a file located on the Internet.

**VPN (Virtual Private Network)** - A security measure to protect data as it leaves one network and goes to another over the Internet.

**WAN (Wide Area Network)**- The Internet.

**WEP (Wired Equivalent Privacy)** - A method of encrypting network data transmitted on a wireless network for greater security.

**WINIPCFG** - A Windows 98 and Me utility that displays the IP address for a particular networking device.

**WLAN (Wireless Local Area Network)** - A group of computers and associated devices that communicate with each other wirelessly.

**WPA (Wi-Fi Protected Access)** - a wireless security protocol using TKIP (Temporal Key Integrity Protocol) encryption, which can be used in conjunction with a RADIUS server.



# Appendix F: Specifications

Model	WRT54GP2A-AT
Standards	IEEE 802.11b, IEEE 802.11g, IEEE 802.3 (10BaseT), IEEE 802.3u (100BaseTX)
Ports/Buttons	One 10/100 RJ-45 Port for Broadband Modem, Four 10/100 RJ-45 Switched Ports, Two RJ-11 Phone Ports for Voice Over IP, One Power Port
Button	Reset
Cabling Type	RJ-45 Ethernet Category 5, RJ-11 Standard Phone Cable
LEDs	Power, WLAN, Ethernet (1-4), Phone(1-2), Internet
Transmit Power	802.11b: Typ. 20 dBm @ Normal Temp Range, 802.11g: Typ. 18 dBm @ Normal Temp Range
UPnP able/cert	Able
Security Features	WEP, WPA
WEP Key Bits	64-Bit, 128-Bit
Voice Protocol	Session Initiation Protocol (SIP v2)
Voice Codecs	G.711 a-law, G.711 $\mu$ -Law, G.726, G.729 A, G.723.1
Ring Voltage	40 - 50 VRMS (typical, balanced ring only)
Ring Frequency	25 Hz

## Wireless-G Broadband Router with 2 Phone Ports

Ringer Equivalence Number	5 per RJ-11 port (over 2000 feet)
Dimensions (W x H x D)	7.32" x 2.48" x 6.08" (186 mm x 63 mm x 154.4 mm)
Unit Weight	19.29 oz. (0.55 kg)
Power	12 V, 1 A
Certifications	FCC
Operating Temp.	0°C to 40°C (32°F to 104°F)
Storage Temp.	-4°F to 140°F (-20°C to 60°C)
Operating Humidity	10% to 85%, Non-Condensing
Storage Humidity	5% to 90%, Non-Condensing

# Appendix G: Warranty Information

## LIMITED WARRANTY

Linksys warrants to You that, for a period of one year (the "Warranty Period"), your Linksys Product will be substantially free of defects in materials and workmanship under normal use. Your exclusive remedy and Linksys' entire liability under this warranty will be for Linksys at its option to repair or replace the Product or refund Your purchase price less any rebates. This limited warranty extends only to the original purchaser.

If the Product proves defective during the Warranty Period call Linksys Technical Support in order to obtain a Return Authorization Number, if applicable. BE SURE TO HAVE YOUR PROOF OF PURCHASE ON HAND WHEN CALLING. If You are requested to return the Product, mark the Return Authorization Number clearly on the outside of the package and include a copy of your original proof of purchase. RETURN REQUESTS CANNOT BE PROCESSED WITHOUT PROOF OF PURCHASE. You are responsible for shipping defective Products to Linksys. Linksys pays for UPS Ground shipping from Linksys back to You only. Customers located outside of the United States of America and Canada are responsible for all shipping and handling charges.

ALL IMPLIED WARRANTIES AND CONDITIONS OF MERCHANTABILITY OR FITNESS FOR A PARTICULAR PURPOSE ARE LIMITED TO THE DURATION OF THE WARRANTY PERIOD. ALL OTHER EXPRESS OR IMPLIED CONDITIONS, REPRESENTATIONS AND WARRANTIES, INCLUDING ANY IMPLIED WARRANTY OF NON-INFRINGEMENT, ARE DISCLAIMED. Some jurisdictions do not allow limitations on how long an implied warranty lasts, so the above limitation may not apply to You. This warranty gives You specific legal rights, and You may also have other rights which vary by jurisdiction.

This warranty does not apply if the Product (a) has been altered, except by Linksys, (b) has not been installed, operated, repaired, or maintained in accordance with instructions supplied by Linksys, or (c) has been subjected to abnormal physical or electrical stress, misuse, negligence, or accident. In addition, due to the continual development of new techniques for intruding upon and attacking networks, Linksys does not warrant that the Product will be free of vulnerability to intrusion or attack.

TO THE EXTENT NOT PROHIBITED BY LAW, IN NO EVENT WILL LINKSYS BE LIABLE FOR ANY LOST DATA, REVENUE OR PROFIT, OR FOR SPECIAL, INDIRECT, CONSEQUENTIAL, INCIDENTAL OR PUNITIVE DAMAGES, REGARDLESS OF THE THEORY OF LIABILITY (INCLUDING NEGLIGENCE), ARISING OUT OF OR RELATED TO THE USE OF OR INABILITY TO USE THE PRODUCT (INCLUDING ANY SOFTWARE), EVEN IF LINKSYS HAS BEEN ADVISED OF THE POSSIBILITY OF SUCH DAMAGES. IN NO EVENT WILL LINKSYS' LIABILITY EXCEED THE AMOUNT PAID BY YOU FOR THE PRODUCT. The foregoing limitations will apply even if any warranty or remedy provided under this Agreement fails of its essential purpose. Some jurisdictions do not allow the exclusion or limitation of incidental or consequential damages, so the above limitation or exclusion may not apply to You.

Please direct all inquiries to: Linksys, P.O. Box 18558, Irvine, CA 92623.

# Appendix H: Regulatory Information

## FCC STATEMENT

This product has been tested and complies with the specifications for a Class B digital device, pursuant to Part 15 of the FCC Rules. These limits are designed to provide reasonable protection against harmful interference in a residential installation. This equipment generates, uses, and can radiate radio frequency energy and, if not installed and used according to the instructions, may cause harmful interference to radio communications. However, there is no guarantee that interference will not occur in a particular installation. If this equipment does cause harmful interference to radio or television reception, which is found by turning the equipment off and on, the user is encouraged to try to correct the interference by one or more of the following measures:

Reorient or relocate the receiving antenna

Increase the separation between the equipment or devices

Connect the equipment to an outlet other than the receiver's

Consult a dealer or an experienced radio/TV technician for assistance

## FCC Radiation Exposure Statement

This equipment complies with FCC radiation exposure limits set forth for an uncontrolled environment. This equipment should be installed and operated with minimum distance 20cm between the radiator and your body.

## EC DECLARATION OF CONFORMITY (EUROPE)

Linksys declares that this product conforms to the specifications listed below, following the provisions of the European R&TTE directive 1999/5/EC:

EN 301 489-1, 301 489-17 General EMC requirements for Radio equipment.

EN 609 50 Safety

EN 300-328-1, EN 300-328-2 Technical requirements for Radio equipment.

Caution: This equipment is intended to be used in all EU and EFTA countries. Outdoor use may be restricted to certain frequencies and/or may require a license for operation. Contact local Authority for procedure to follow.

Note: Combinations of power levels and antennas resulting in a radiated power level of above 100 mW equivalent isotropic radiated power (EIRP) are considered as not compliant with the above mentioned directive and are not

## Wireless-G Broadband Router with 2 Phone Ports

allowed for use within the European community and countries that have adopted the European R&TTE directive 1999/5/EC.

For more details on legal combinations of power levels and antennas, contact Linksys Corporate Compliance.

Linksys vakuuttaa täten että dieses produkt tyypinen laite on direktiivin 1999/5/EY oleellisten vaatimusten ja sitä koskevien näiden direktiivien muiden ehtojen mukainen.

Linksys déclare que le produit est conforme aux conditions essentielles et aux dispositions relatives à la directive 1999/5/EC.

Belgique:

Dans le cas d'une utilisation privée, à l'extérieur d'un bâtiment, au-dessus d'un espace public, aucun enregistrement n'est nécessaire pour une distance de moins de 300m. Pour une distance supérieure à 300m un enregistrement auprès de l'IBPT est requise. Pour une utilisation publique à l'extérieur de bâtiments, une licence de l'IBPT est requise. Pour les enregistrements et licences, veuillez contacter l'IBPT.

France:

2.4 GHz Bande : les canaux 10, 11, 12, 13 (2457, 2462, 2467, et 2472 MHz respectivement) sont complètement libres d'utilisation en France (en utilisation intérieur). Pour ce qui est des autres canaux, ils peuvent être soumis à autorisation selon le département. L'utilisation en extérieur est soumis à autorisation préalable et très restreint.

Vous pouvez contacter l'Autorité de Régulation des Télécommunications (<http://www.art-telecom.fr>) pour de plus amples renseignements.

### SAFETY NOTICES

Caution: To reduce the risk of fire, use only No.26 AWG or larger telecommunication line cord.

Do not use this product near water, for example, in a wet basement or near a swimming pool.

Avoid using this product during an electrical storm. There may be a remote risk of electric shock from lightning.

# Appendix I: Contact Information

## AT&T

Need to contact AT&T?

If you have technical, installation, repair, or billing questions, you can call AT&T at:

24-hour: 1-866-596-8464  
(toll-free from US and Canada)

To e-mail your questions, visit AT&T online to access your account at: After you log in, click **Help**. Then click **EMAIL AN AGENT** in the *CONTACT US* section.

<https://www.callvantage.att.com/>

## Linksys

Need to contact Linksys?

Visit us online for information on the latest products and updates to your existing products at:

<http://www.linksys.com> or  
<ftp://www.linksys.com>

Can't find information about a product you want to buy on the web? Do you want to know more about networking with Linksys products? Give our advice line a call at:  
Or fax your request in to:

800-546-5797 (LINKSYS)  
949-823-3002

If you experience problems with any Linksys product, you can call us at:  
Don't wish to call? You can e-mail us at:

800-326-7114  
[support@linksys.com](mailto:support@linksys.com)

If any Linksys product proves defective during its warranty period, you can call the Linksys Return Merchandise Authorization department for obtaining a Return Authorization Number at:  
(Details on Warranty and RMA issues can be found in the Warranty Information section in this Guide.)

949-823-3000

## Free Manuals Download Website

<http://myh66.com>

<http://usermanuals.us>

<http://www.somanuals.com>

<http://www.4manuals.cc>

<http://www.manual-lib.com>

<http://www.404manual.com>

<http://www.luxmanual.com>

<http://aubethermostatmanual.com>

Golf course search by state

<http://golfingnear.com>

Email search by domain

<http://emailbydomain.com>

Auto manuals search

<http://auto.somanuals.com>

TV manuals search

<http://tv.somanuals.com>