



# Efficiency+ High Efficiency, Gas Fired Heating Boiler

## Taking Comfort and Efficiency to the Next Level

### An Investment You'll Feel Right at Home with

Heating your home or business is one of the biggest investments you'll ever make...and you deserve a heating system that delivers unmatched comfort, dependability and energy savings, year after year. That's why Efficiency+ from Lochinvar is the smart choice for heating.

Efficiency+, with inputs ranging from 150,000 to 300,000 Btu/hr, more than lives up to its name, with an outstanding 84% AFUE. It has two-stage firing that saves fuel by closely matching heat output to system demand, maximizing operating efficiency.

### Two-Stage Firing

During the majority of the heating season less than full boiler input is required to satisfy a heat load. For this reason Lochinvar has developed a two-stage firing system. Two-stage firing — standard equipment on all Efficiency+ boilers — provides dramatic fuel savings by reducing heat output 50%. That means when outdoor temperatures become warmer, the boiler will use less fuel to maintain comfortable indoor temperatures.

**High Fire**  
With standard two-stage firing, Efficiency+ reduces gas consumption.

**Low Fire**  
On colder days the boiler fires at full input.

**Stage 1**   **Stage 2**  
In warmer conditions Efficiency+ reduces heat output to save energy and reduce cycling.

### Trouble-Free Operation

There's nothing more irritating than a boiler that sputters out when you need it most. That's why Efficiency+ has an integrated boiler control that ensures safe burner operation and prevents nuisance flame-failures.

**84% AFUE**

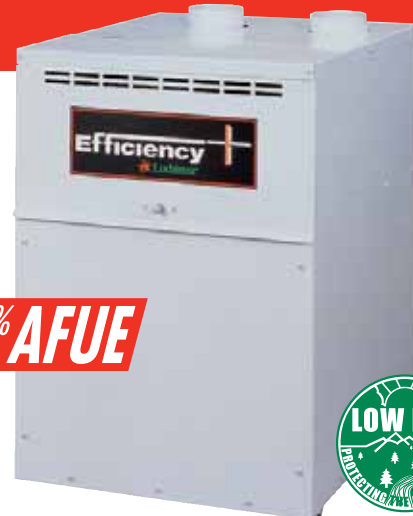

Efficiency+ is also designed to operate on low gas pressure — a key consideration in regions where natural gas supply pressure is in the 4 - 5 inch range.

### Space-Saving Design

With Efficiency+, you get high efficiency heating in a surprisingly compact unit. It fits easily where other boilers won't.

The Efficiency+ is remarkably light because of its copper tube heat exchanger and other design breakthroughs. For example, Efficiency+ uses Loch-Heat™ tile to reduce unit weight by 25% as compared to conventional cast refractory materials. Loch-Heat tile also increases efficiency by reflecting heat back into the combustion chamber rather than absorbing it.



## Thermal Efficiency—Your Reliable Yardstick For Savings

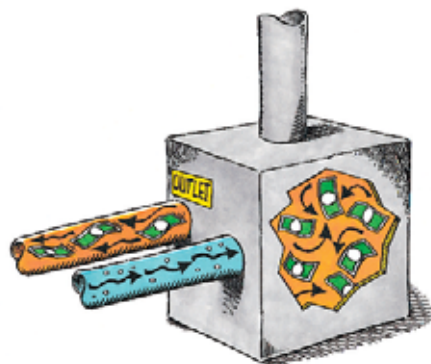

**Thermal Efficiency**



**Combustion Efficiency**

Efficiency+ has an 84% thermal efficiency rating, which means 84 cents out of every fuel dollar are used to create heat. Other efficiency ratings can be misleading and result in artificially high ratings.

# Efficiency+® Boiler Dimensions & Specifications

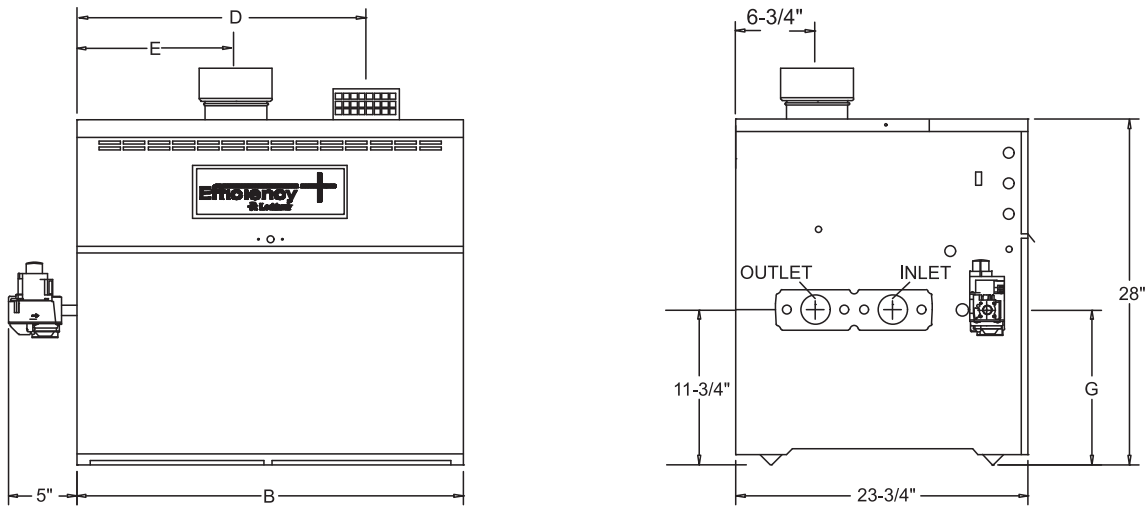

Efficiency+ Boiler					Dimensions & Specifications						
Model Number	Input Max MBH	AFUE %	Heating Capacity MBH	Net I=B=R MBH	B	D	E	G	Gas Conn.	Vent Size	Shipping Weight
EBN150	150	83.2	129	112	19-3/4"	16"	7-1/4"	11-3/4"	3/4"	5"	245
EBN200	200	83.1	170	148	23-3/4"	20"	9-1/4"	11-3/4"	3/4"	5"	265
EBN250	250	83.2	218	190	27-1/2"	23-3/4"	11"	11-3/4"	3/4"	6"	290
EBN300	300	84.0	252	219	31-1/4"	27-1/2"	13"	11-3/4"	3/4"	6"	310

Notes: Change 'N' to 'L' to denote L.P. gas models  
 Net ratings based on piping and pick-up allowance of 1.15

Electrical Requirements: 120 VAC / 2 AMP  
 Water connections are 1-1/2" NPT  
 Performance data based on manufacturer test results.

## Standard Features

- 84% AFUE
- Two Stage Firing
- Sealed Combustion Chamber
- Stainless Steel Burners
- Low NOx Operation Exceeds the most Stringent Air Quality Requirements
- ASME Copper Finned Tube Heat Exchanger
- 160 PSI Working Pressure
- Gasketless Heat Exchanger Design
- Automatic Reset High Limit
- Loch-Heat Ceramic Tile Combustion Chamber
- Hot Surface Ignition
- ASME Pressure Relief Valve
- 24 Volt Control System
- Pump Relay

- 10 Year Limited Warranty on Heat Exchanger (See warranty for details)

## Optional Equipment

- Adjustable High Limit w/ Manual Reset
- Alarm Bell
- Cupro-Nickel Heat Exchanger
- Flow Switch
- Indoor/Outdoor Reset
- Manual Reset Low Water Cut-Off w/test
- MP<sup>2</sup> Sequencer
- Stack Frame
- Pump Delay w/ Freeze Protection

## Available Firing Systems

M9 Hot Surface Ignition with Electronic Supervision (Standard)

M7 California Code

For Ease In Ordering By Model Number

E	B	N	150
Efficiency+	Boiler	Natural Gas	Input

This is a 150,000 Btu/hr natural gas Efficiency+ boiler. Registered Under U.S. Patent #5,989,020

## Venting Options

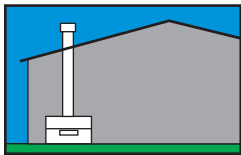

**Conventional**  
 Vents into conventional flue or vent breaching using Type B double wall vent.

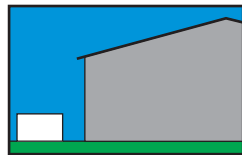

\*\* **Outdoor Vent Kit**  
 Use when indoor space is a problem or if outdoor location gives better access.

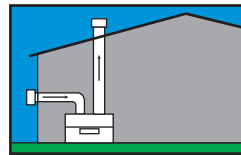

\*\* **E+ DirectAir Vent with Sidewall Inlet**  
 Draws fresh combustion air from an outside wall horizontally, and vents combustion by-products through a vertical flue.

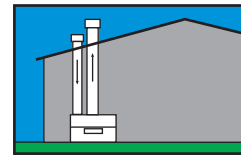

**Direct Vent Vertical**  
 Draws fresh combustion air from outside, and vents combustion by-products through a vertical flue.

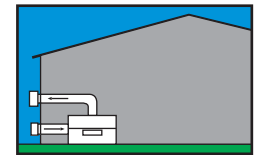

\*\* **Direct Vent Horizontal**  
 Draws fresh combustion air from outside, then vents by-products through a side wall.

\*\* Requires factory supplied vent kit.



**Lochinvar**  
 High Efficiency Water Heaters, Boilers and Pool Heaters



Lochinvar Corporation • 300 Maddox Simpson Pkwy • Lebanon, TN 37090 • 615-889-8900 / Fax: 615-547-1000

[www.Lochinvar.com](http://www.Lochinvar.com)

## Free Manuals Download Website

<http://myh66.com>

<http://usermanuals.us>

<http://www.somanuals.com>

<http://www.4manuals.cc>

<http://www.manual-lib.com>

<http://www.404manual.com>

<http://www.luxmanual.com>

<http://aubethermostatmanual.com>

Golf course search by state

<http://golfingnear.com>

Email search by domain

<http://emailbydomain.com>

Auto manuals search

<http://auto.somanuals.com>

TV manuals search

<http://tv.somanuals.com>