



INSTALLATION INSTRUCTIONS

INTRODUCTION

The MP² is capable of controlling the supply water temperature for up to nine ON / OFF stages based on outdoor temperature, control for the Domestic Hot Water (DHW) generation, a set point requirement or optionally an external input signal (0 - 10 V (dc)). A large easy to read display provides current system temperatures and operating status (FIG. 1). The control has outputs for a primary pump and a combustion air damper or alarm. Based on the mode of operation selected, the control can operate different combinations of boiler stages and boiler pumps.

ADDITIONAL FUNCTIONS INCLUDE:

- Installer and Advanced Access Levels
- Primary Pump Output
- Individual Boiler Pump Outputs (in applicable modes)
- Pump Exercising
- Pump Purging (primary and boiler)
- Boiler Demand for Space Heating Loads
- DHW Demand for DHW Loads
- Set Point Demand for Set Point Loads
- Test Sequence to Ensure Proper Component Operation
- Setback Input for Energy Savings
- 0 - 10 V (dc) Input Signal

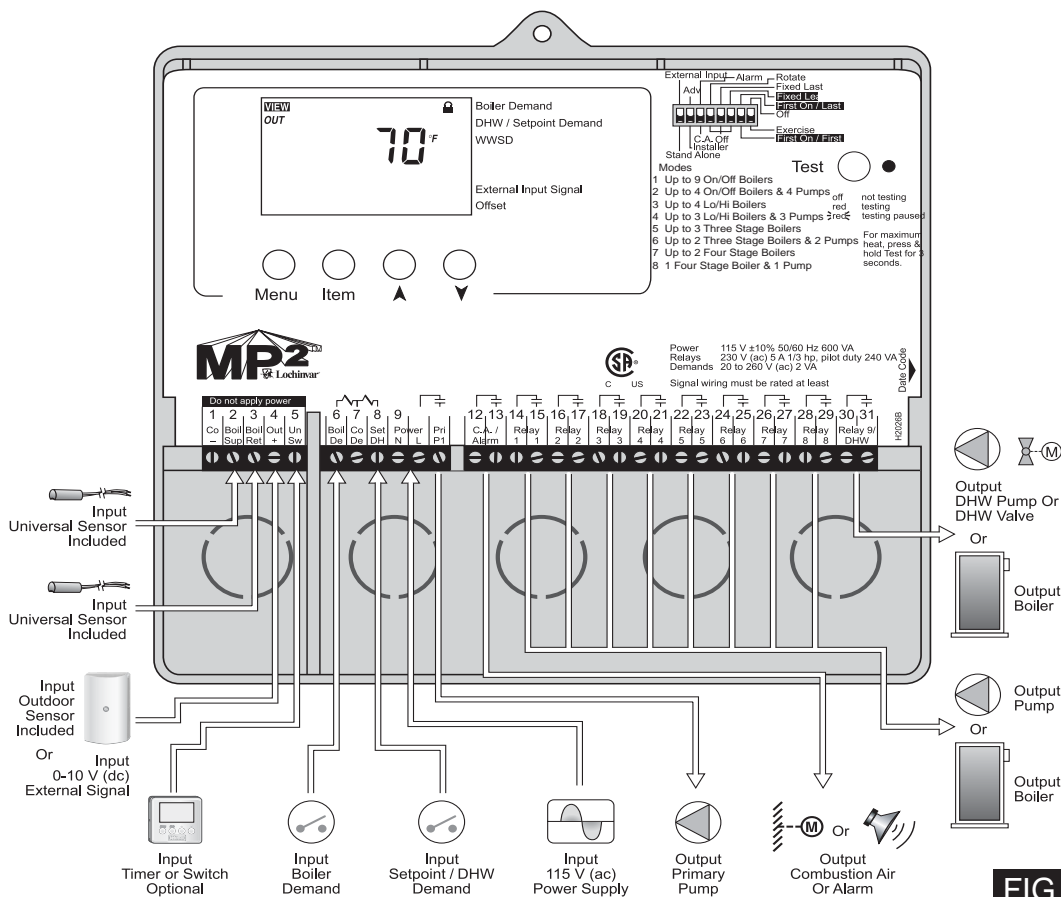

This instruction manual is organized into four main sections: 1) Sequence of Operation, 2) Installation, 3) Control Settings, and 4) Testing and Troubleshooting. The Sequence of Operation section has seven sub-sections. We recommend reading Section A: General Operation of the Sequence of Operation, as this contains important information on the overall operation of the control. Followed by the sub-sections that apply to your installation. The Control Settings section (starting at DIP Switch Settings) of this instruction manual describes the various items that are adjusted and displayed by the control. The control functions of each adjustable item are described in the Sequence of Operation.

USER INTERFACE

The control uses a Liquid Crystal Display (LCD) as the method of supplying information. The LCD is used in order to setup and monitor the operation of your system. The control has four push buttons (FIG. 2) for selecting and adjusting settings. As you program your control, record your settings in the ADJUST menu table which is found in the second half of this instruction manual.

TABLE OF CONTENTS

Introduction	1
User Interface	2
Display	3
Symbol Description	3
Sequence of Operation	4
<i>Section A: General Operation</i>	4
<i>Section B: Staging</i>	6
<i>Section C: Pump Operation</i>	8
<i>Section D: Boiler Reset</i>	9
<i>Section E: DHW</i>	12
<i>Section F: Set Point</i>	14
<i>Section G: External Input</i>	15
Installation	17
DIP Switch Settings	22
Control Settings	22
<i>View Menu</i>	24
<i>Adjust Menu</i>	25
Testing the Control	29
Error Messages	30
Technical Data	31
Typical Boiler Installation	32
Typical DWH Priority Heating Package System ..	34
Notes Page	35

MENU

All of the items displayed by the control are organized into two menus. These menus are listed on the top left hand side of the display (Menu Field). To select a menu, use the Menu button. By pressing and releasing the Menu button, the display switches between the two menus. Once a menu is selected, there will be a group of items that can be viewed within the menu, see Figure 2.

ITEM

The abbreviated name of the selected item will be displayed in the item field of the display. To view the next available item, press and release the Item button. Once you have reached the last available item in a menu, pressing and releasing the Item button will return the display to the first item in the selected menu. The items can be quickly scrolled through by holding the Item button and pressing the down arrow button. To rapidly scroll through the items in the reverse order, hold the Item button and press the up arrow button, see Figure 2.

ADJUST

To make an adjustment to a setting in the control, begin by selecting the ADJUST menu using the Menu button. Then select the desired item using the Item button. Finally, use the up arrow button, or down arrow button to make the adjustment. Additional information can be gained by observing the Status field of the LCD. The status field will indicate which of the control's outputs are currently active. Most symbols in the status field are only visible when the VIEW menu is selected, see Figure 2.

DISPLAY

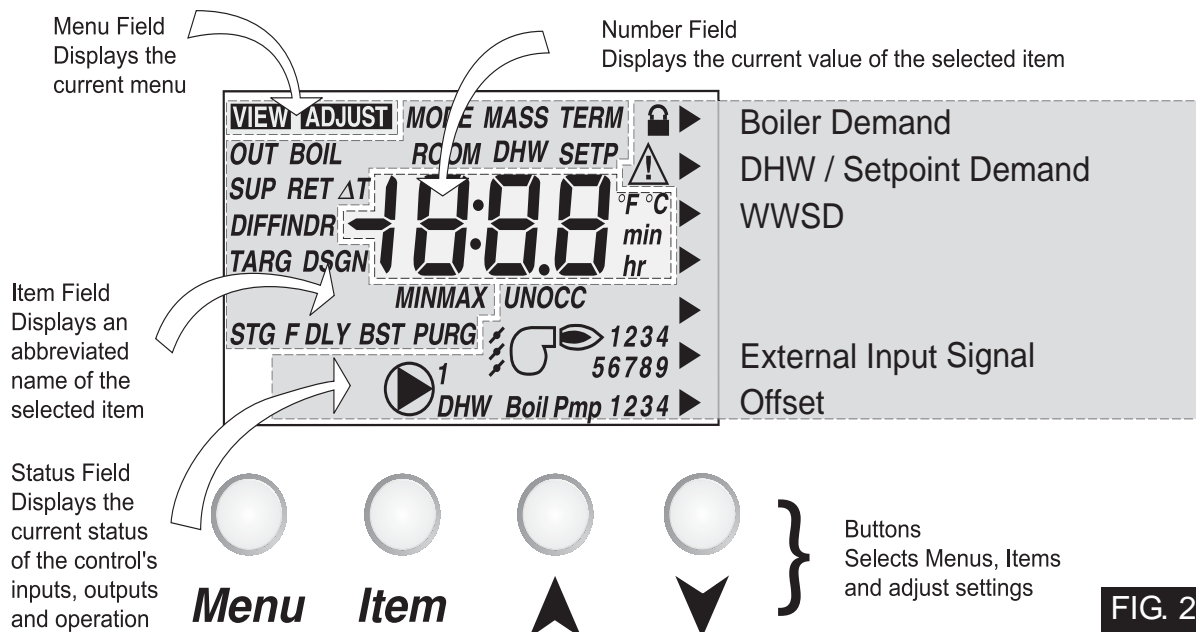

SYMBOL DESCRIPTION

Stage Displays which stage relays are turned on.	UnOccupied Schedule <i>UNOCC</i> Displays when the control is in UnOccupied Mode.
Primary Pump Displays when the primary pump relay is turned on.	Occupied Schedule <i>OCC</i> Displays when the control is in Occupied Mode.
Boiler Pump <i>Boil Pmp 1234</i> Displays which boiler pump relays are turned on.	Installer Access Level Displays when the installer / Advanced Dip switch is set to installer.
Combustion Air Damper Displays when the Combustion Air Damper relay is turned on.	Pointer Displays the control operation as indicated by the text.
Delta T ΔT The current difference between the supply and return temperatures.	Warning / Alarm Displays when an error exists or the alarm relay is turned on.
°F, °C, min, hr <i>min hr</i> Units of measurement.	DHW <i>DHW</i> Displays when the DHW relay is turned on.

FIG. 3

DEFINITIONS

The following defined terms and symbols are used throughout this manual to bring attention to the presence of hazards of various risk levels, or to bring attention to important information concerning the life of the product, see Figure 4 below.

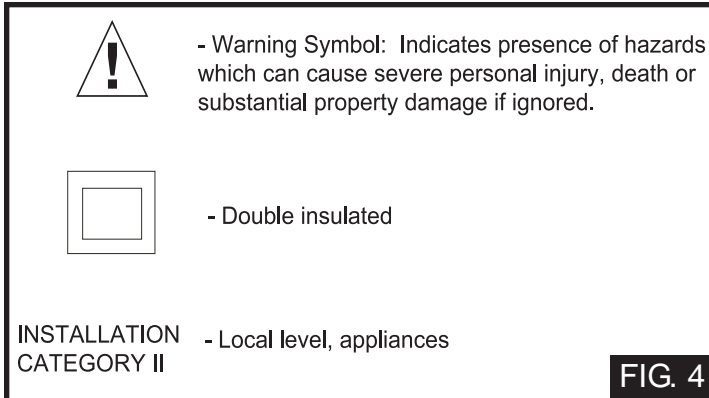

SEQUENCE OF OPERATION

SECTION A: GENERAL OPERATION

POWERING UP THE CONTROL

When the control is powered up, all segments in the LCD are turned on for two seconds. The control displays the control type number in the LCD for two seconds. Next, the software version is displayed for two seconds. Finally, the control enters the normal operating mode.

OPERATION

The control operates up to nine on / off heat sources to control the supply water temperature to a hydronic system. The supply water temperature is based on either the current outdoor temperature, an external 0 - 10 V (dc) or 2 - 10 V (dc) signal, or a fixed set point.

Boiler Reset (Stand Alone)

When a boiler demand signal from the heating system is present, the control operates the boiler(s) to maintain a supply temperature based on the outdoor air temperature and Characterized Heating Curve settings, see Figure 5.

Domestic Hot Water

When a DHW demand signal from a DHW aquastat is present, the control operates the boiler(s) to maintain the supply water temperature at least as hot as the DHW XCHG setting. Refer to section E.

Set Point

When a set point demand signal from a set point system is present, the control operates the boiler(s) to maintain the supply water temperature at least as hot as the SETP setting. Refer to section F.

External Input 0 - 10 V (dc) or 2 - 10 V (dc)

When an external input signal is present, the control converts the signal to a target supply temperature. The control operates the boiler(s) to maintain the required supply water temperature.

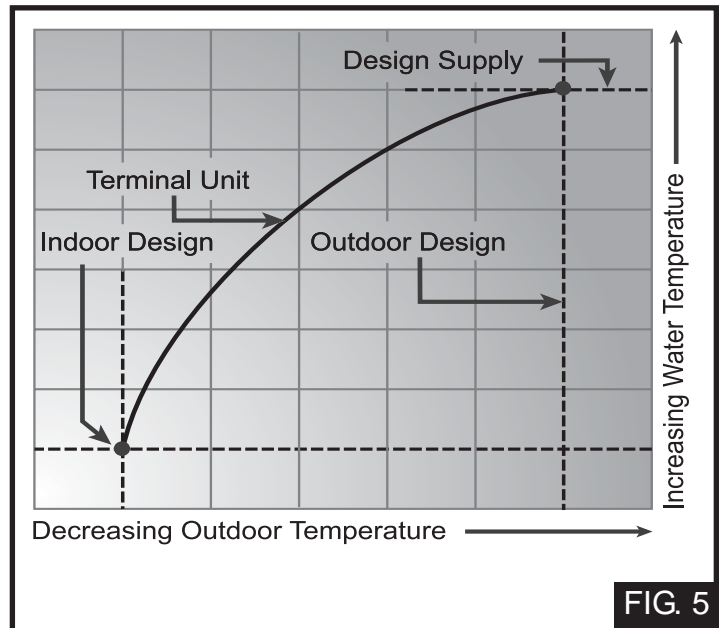

SETBACK (UNOCCUPIED)

To provide greater energy savings, the control has a setback feature (FIG. 6). With setback, the supply water temperature in the system is reduced when the building is unoccupied. By reducing the supply water temperature, the air temperature in the space may be reduced even when thermostat(s) are not turned down. Any time the UnO Sw (5) and the Com - (1) are connected, the control operates in the UnOccupied mode. When in the UnOccupied mode, the UNOCC segment is displayed in the LCD. The control adjusts the supply water temperature based on the UNOCC settings made in the control. This feature has no effect when the control is used in the External Input mode.

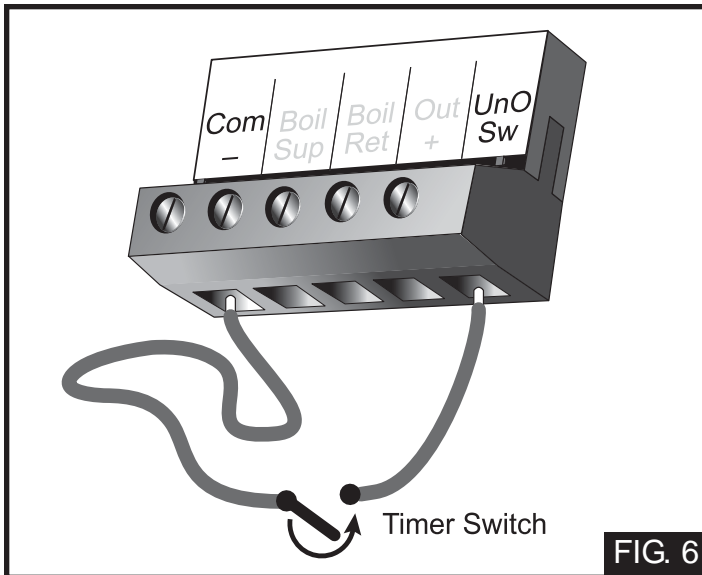

FIG. 6

COMBUSTION AIR OR ALARM CONTACT

The control has an isolated contact that can be used as either a combustion air damper contact or an alarm contact. This selection is made using the C. A. / Alarm DIP switch.

Combustion Air (C. A.)

When the DIP switch is set to C. A., terminals 12 and 13 can be used as a switch to operate a combustion air damper. This contact closes prior to the first stage operating on the control. The amount of time that the contact closes prior to the first stage operating is set using the combustion delay setting. The combustion air contact remains closed for a minimum of 15 seconds after the last stage is turned off.

Alarm

When the DIP switch is set to Alarm, terminals 12 and 13 can be used as a switch to operate an alarm circuit. This contact closes whenever an error message is present on the control. When the alarm contact is activated, refer to the Error Messages section of this manual to determine the cause of the alarm. Once the fault has been fixed, the alarm can be cleared by pressing either the Menu, Item, up arrow or down arrow button.

Boiler Alarm

The control can monitor the boiler supply temperature and provide an alarm if the temperature does not increase within a certain amount of time. The amount of time can be set using the Boiler Alarm setting. This alarm can be used to determine if the boilers have failed to fire. To reset the alarm, press and hold the up and down arrow buttons for 5 seconds while in the VIEW menu.

ROTATION

The control's Equal Run Time Rotation function is fixed at 48 hours. The firing order of the boilers change whenever one boiler accumulates 48 hours more running time than any other boiler. After each rotation, the boiler with the least running hours is the first to fire and the boiler with the most running hours is the last to fire. This function ensures that all the boilers being rotated receive equal amounts of use. When the Rotate / Off DIP switch is set to the Off position, the firing sequence always begins with the lowest boiler to the highest boiler, see Figure 7 below.

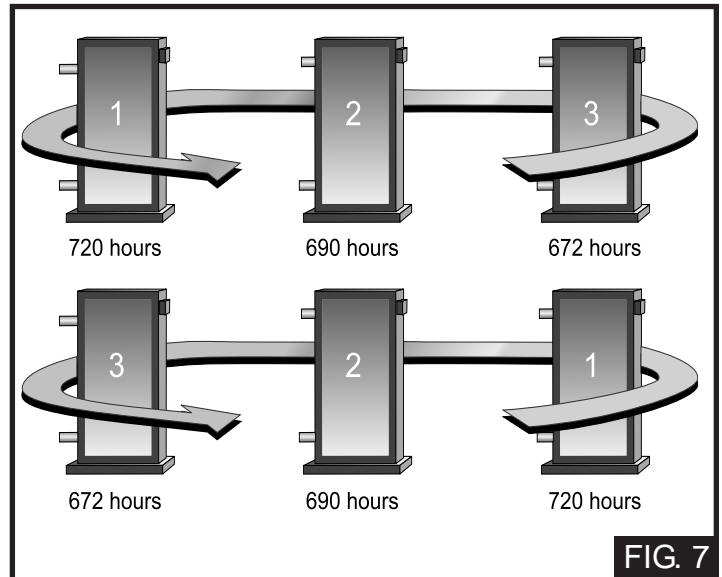

FIG. 7

Fixed Lead Rotation

In some applications, it may be desirable to have the first boiler fire first at all times while the firing sequence of the remaining boilers is changed using Equal Run Time Rotation. This rotation option is selected by setting the Fixed Lead / Off DIP switch to the Fixed Lead position.

First On / Last Off or First On / First Off

When using the Fixed Lead rotation option, a selection must be made between First On / Last Off and First On / First Off using the DIP switch. When First On / Last Off is selected, the lead boiler is always staged on first and staged off last. When First On / First Off is selected, the lead boiler is always staged on first and staged off first. This DIP switch is only read by the control when the Fixed Lead / Off DIP switch is set to Fixed Lead.

Fixed Last

In some applications, it may be desirable to have the last boiler fire last at all times while the firing sequence of the remaining boilers is changed using Equal Run Time Rotation. This rotation option is selected by setting the Fixed Last / Off DIP switch to Fixed Last. With a fixed last rotation, the last boiler is the last to stage on and the first to stage off.

Resetting the Rotation Sequence

To reset the rotation sequence, set the Rotate / Off DIP switch to the Off setting for 5 seconds and then return the DIP switch to the Rotate setting.

RUNNING TIMES

The control displays the accumulated running time of each boiler in the VIEW menu. When using a multi-stage boiler, the running time that is displayed is the total number of running hours of the Lo stage of the boiler.

Resetting the Running Times

To reset the running time for each boiler, select the appropriate running time in the VIEW menu. Next, press the up and down arrow buttons simultaneously until CLR is displayed.

EXERCISING

The control has a built-in exercising feature that is selected through the Exercise / Off DIP switch. To enable the exercising feature set the Exercise / Off DIP switch to Exercise. If exercising is enabled, the control ensures that each pump is operated at least once every 3 days. If a pump has not been operated at least once every 3 days, the control turns on the output for 10 seconds. This minimizes the possibility of the pump seizing during a long period of inactivity. While the control is exercising, the Test LED flashes quickly.

Note: The exercising function does not work if power to the control or pumps is disconnected.

RELOADING FACTORY DEFAULTS

To reload the factory defaults, power down the control for 10 seconds. Power up the control while simultaneously holding the Menu and down arrow buttons. The control will now display the E01 error message. To clear this error message, follow the procedure in the Error Messages section of this manual.

BOILER MINIMUM

The boiler minimum is the lowest temperature that the control is allowed to use as a boiler target temperature. During mild conditions, if the control calculates a boiler target temperature that is below the BOIL MIN setting, the boiler target temperature is adjusted to at least the BOIL MIN setting. During this condition, if the boiler(s) is operating, the minimum segment is turned on in the display when viewing either the boiler supply temperature or the boiler target temperature. Set the BOIL MIN setting to the boiler manufacturer's recommended temperature.

BOILER MAXIMUM

The boiler maximum is the highest temperature that the control is allowed to use as a boiler target temperature. If the control does target the BOIL MAX setting, and the boiler temperature is near the boiler maximum temperature, the maximum segment will be displayed in the LCD while either the boiler target temperature or the boiler supply temperature is being viewed. At no time does the control operate the boiler(s) above 248°F (120°C).

SECTION B: STAGING OPERATION

SECTION B1: STAGING

Mode

The control is capable of staging single stage, two stage, three stage or four stage on / off heat sources. In certain modes of operation the control is capable of controlling the individual boiler pumps. The control has 8 modes of operation based on the type of staging and pump operation that is desired. The following describes the modes of operation:

Mode 1: 9 Single Stage Boilers and a primary pump.

Mode 2: 4 Single Stage Boilers with individual boiler pumps and a primary pump.

Mode 3: 4 Lo/Hi boilers and a primary pump.

Mode 4: 3 Lo/Hi boilers with individual boiler pumps and a primary pump.

Mode 5: 3 Three Stage Boilers and a primary pump.

Mode 6: 2 Three Stage Boilers with individual boiler pumps and a primary pump.

Mode 7: 2 Four Stage Boilers and a primary pump.

Mode 8: 1 Four Stage Boiler with a boiler pump and a primary pump.

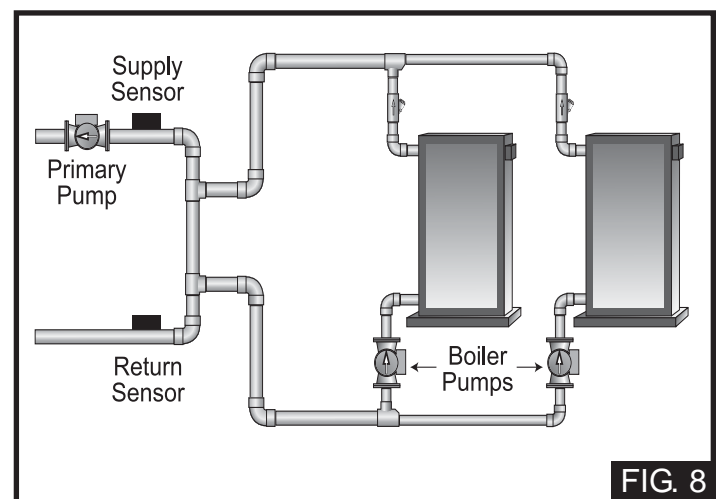

FIG. 8

	RELAY 1	RELAY 2	RELAY 3	RELAY 4	RELAY 5	RELAY 6	RELAY 7	RELAY 8	RELAY 9
MODE 1	Boiler 1	Boiler 2	Boiler 3	Boiler 4	Boiler 5	Boiler 6	Boiler 7	Boiler 8	Boiler 9
MODE 2	Boiler 1	Boiler 1 Pump	Boiler 2	Boiler 2 Pump	Boiler 3	Boiler 3 Pump	Boiler 4	Boiler 4 Pump	---
MODE 3	Boiler 1 Stage 1	Boiler 1 Stage 2	Boiler 2 Stage 1	Boiler 2 Stage 2	Boiler 3 Stage 1	Boiler 3 Stage 2	Boiler 4 Stage 1	Boiler 4 Stage 2	---
MODE 4	Boiler 1 Stage 1	Boiler 1 Stage 2	Boiler 1 Pump	Boiler 2 Stage 1	Boiler 2 Stage 2	Boiler 2 Pump	Boiler 3 Stage 1	Boiler 3 Stage 2	Boiler 3 Pump
MODE 5	Boiler 1 Stage 1	Boiler 1 Stage 2	Boiler 1 Stage 3	Boiler 2 Stage 1	Boiler 2 Stage 2	Boiler 2 Stage 3	Boiler 3 Stage 1	Boiler 3 Stage 2	Boiler 3 Stage 3
MODE 6	Boiler 1 Stage 1	Boiler 1 Stage 2	Boiler 1 Stage 3	Boiler 1 Pump	Boiler 2 Stage 1	Boiler 2 Stage 2	Boiler 2 Stage 3	Boiler 2 Pump	---
MODE 7	Boiler 1 Stage 1	Boiler 1 Stage 2	Boiler 1 Stage 3	Boiler 1 Stage 4	Boiler 2 Stage 1	Boiler 2 Stage 2	Boiler 2 Stage 3	Boiler 2 Stage 4	---
MODE 8	Boiler 1 Stage 1	Boiler 1 Stage 2	Boiler 1 Stage 3	Boiler 1 Stage 4	Boiler 1 Pump	---	---	---	---

FIG. 9

Lo / Hi OR Lo / Lo

When using multi-stage boilers, a selection must be made regarding the staging order of the boiler(s). This adjustment is made in the ADJUST menu of the control.

Lo / Hi

If the Lo/Hi staging option is selected the control stages in sequence all of the stages in a single boiler. Once all of the stages are turned on, the control then stages in sequence all of the stages in the next boiler in the rotation sequence.

Lo / Lo

If the Lo/Lo staging option is selected, the control stages all of the Lo stage outputs in all of the boilers first. Once all of the boilers are operating on their Lo stages, the control then operates the second stage in each boiler in the same order.

STAGING

The control operates up to nine stages to supply the required temperature. After a stage is turned on in the firing sequence, the control waits for the minimum time delay. After the minimum time delay between stages has expired, the control examines the control error to determine when the next stage is to fire. The control error is determined using Proportional, Integral and Derivative (PID) logic.

Proportional compares the actual supply temperature to the boiler target temperature. The colder the supply water temperature, the sooner the next stage is turned on.

Integral compares the actual supply temperature to the boiler target temperature over a period of time.

Derivative compares how fast or slow the supply water temperature is changing. If the supply temperature is increasing slowly, the next stage is turned on sooner. If the supply temperature is increasing quickly, the next stage is turned on later, if at all.

FIRE DELAY

The Fire Delay is the time delay that occurs between the time that the control closes a stage contact to fire a stage and the burner fires for that stage. The fire delays for the first and third stages in a boiler are adjustable using the F DLY 1 and F DLY 2 settings. The fire delay for the second and the fourth stages is fixed at 10 seconds, see Figure 10 below.

Fire Delay 1

Fire Delay 1 is available in all modes of operation. Fire Delay 1 is the fire delay of the first stage of the boiler.

Fire Delay 2

Fire Delay 2 is only available in the modes of operation for Three and Four Stage Boilers. Fire Delay 2 is the fire delay of the third stage of the boiler.

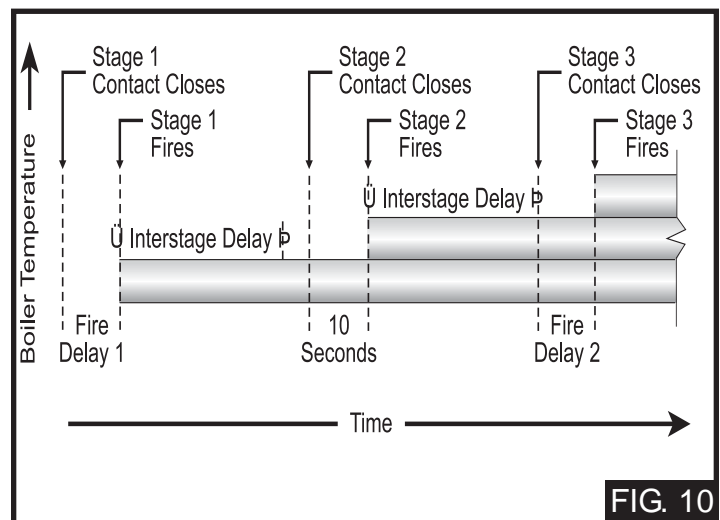

FIG. 10

STAGE DELAY

The stage delay is the minimum time delay between the firing of stages. After this delay has expired the control can fire the next stage if it is required. This setting can be adjusted manually or set to an automatic setting. When the automatic setting is used, the control determines the best stage delay based on the operation of the system.

BOILER MASS

The BOIL MASS setting allows the installer to adjust the control to the thermal mass of the type of heat sources used in the application. The BOIL MASS setting also adjusts the minimum inter-stage delay time when operating with an automatic differential.

Lo (1)

The Lo setting is selected if the boiler(s) that is used has a low thermal mass. This means that the boiler(s) has a very small water content and has very little metal in the heat exchanger. A boiler that has a low thermal mass comes up to temperature quite rapidly when fired. This is typical of many copper fin-tube boilers. The Lo MASS setting provides the quickest staging on of boilers.

Med (2)

The Med setting is selected if the boiler(s) that is used has a medium thermal mass. This means that the boiler(s) either has a large water content and a low metal content or a low water content and a high metal content. This is typical of many modern residential cast iron boilers or steel tube boilers. The Med MASS setting stages on additional boilers at a slower rate than the Lo MASS setting.

Hi (3)

The Hi setting is selected if the boiler(s) that is used has a high thermal mass. This means that the boiler(s) has both a large water content and a large metal content. A boiler that has a high thermal mass is relatively slow in coming up to temperature. This is typical of many commercial cast iron and steel tube boilers. The HI MASS setting stages on additional boilers at the slowest rate.

DIFFERENTIAL

An on / off heat source must be operated with a differential to prevent short cycling. With the control, either a fixed or an auto differential may be selected. The boiler differential is divided around the boiler target temperature. The first stage contact closes when the supply water temperature is $\frac{1}{2}$ of the differential setting below the boiler target temperature. Additional stages operate if the first stage is unable to bring the supply water temperature up to the boiler target temperature at a reasonable rate. As the supply temperature reaches $\frac{1}{2}$ of the differential above the boiler target temperature, stages are staged off.

Fixed Differential

If the user desires to have a fixed differential, this is set using the BOIL DIFF setting in the ADJUST menu (FIG. 11).

Auto Differential

If the Auto Differential is selected, the control automatically determines the best differential as the load changes. This reduces potential short cycling during light load conditions (FIG. 11).

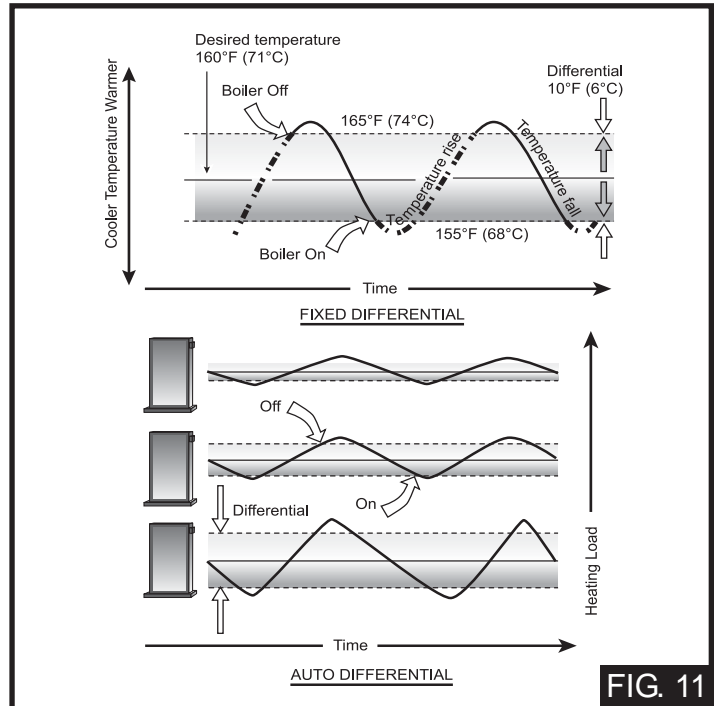

SECTION C: PUMP OPERATION

SECTION C1: PUMP OPERATION

PRIMARY PUMP OPERATION

The primary pump operates under the following conditions:

- The control receives a boiler demand and is not in warm weather shut down (WWSD).
- The control receives a DHW demand when DHW MODE is set to 3 or 4.
- The control receives a set point demand and set point MODE is set to 3.

Primary Pump Purge

After a demand is removed, the control continues to operate the primary pump for a period of time. The maximum length of time that the primary pump continues to run is adjustable using the Purge setting. The primary pump continues to run until either the purging time has elapsed or the boiler supply temperature drops more than a differential below the boiler minimum setting, see Figure 12.

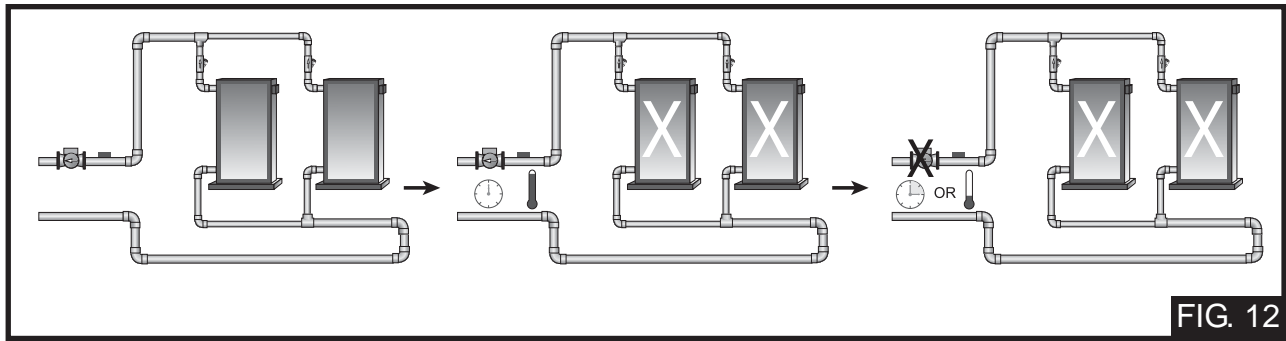

FIG. 12

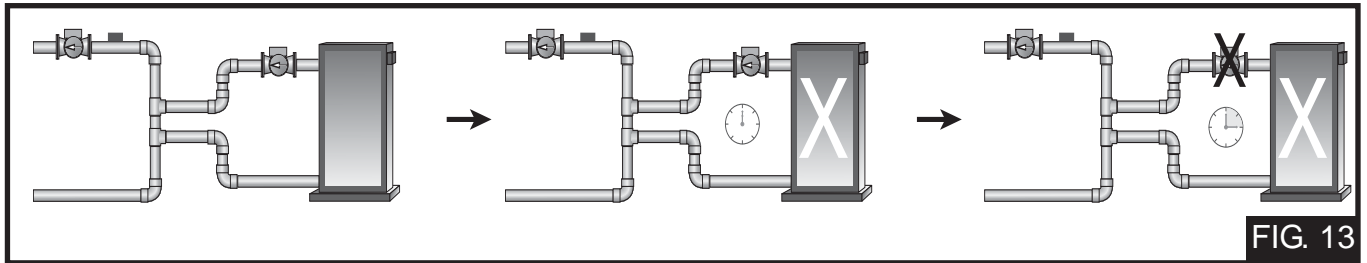

FIG. 13

BOILER PUMP OPERATION

In certain modes of operation, the control can operate the individual boiler pumps on each boiler in addition to the primary pump. The boiler pump turns on prior to the boiler firing and continues to run after the boiler is turned off. The amount of time that the boiler pump turns on prior to the boiler firing is determined by the BOIL MASS setting. If a BOIL MASS of Lo is selected, the boiler pump turns on 15 seconds prior to the boiler. If a BOIL MASS of Medium is selected, the boiler pump turns on 22 seconds prior to the boiler. If a BOIL MASS of Hi is selected, the boiler pump turns on 30 seconds prior to the boiler. However, if the control is operating based on a set point demand, the boiler pump turns on 5 seconds prior to the boiler, see Figure 13.

Boiler Pump Purge

The amount of time that the boiler pump continues to run after the boiler turns off is adjustable using the boiler pump purge setting (PURG Boil Pmp).

SECTION D: BOILER RESET OPERATION

SECTION D1: BOILER RESET (STAND ALONE)

BOILER DEMAND

When operating in the stand-alone mode, a boiler demand is required in order for the control to provide heat to the heating system. A boiler demand is generated by applying a voltage between 24 and 230 V (ac) across the Boiler Demand and Common Demand terminals (6 and 7) (FIG. 14). Once voltage is applied, the Boiler Demand pointer is displayed in the LCD. If the control is not in WWSD, the control closes the primary pump contact. The control calculates a boiler target supply temperature based on the outdoor air temperature and the characterized heating curve settings.

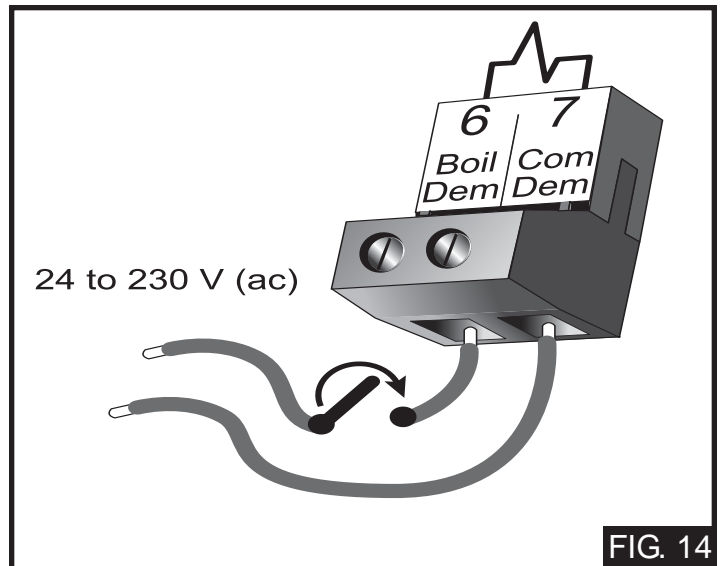

FIG. 14

BOILER TARGET TEMPERATURE

The boiler target temperature is determined from the characterized heating curve settings and the outdoor air temperature. The control displays the temperature that it is currently trying to maintain as the boiler supply temperature. If the control does not presently have a requirement for heat, it does not show a boiler target temperature. Instead, " - - " is displayed in the LCD.

CHARACTERIZED HEATING CURVE

The control varies the supply water temperature based on the outdoor air temperature. The control takes into account the type of terminal unit that the system is using. Since different types of terminal units transfer heat to a space using different proportions of radiation, natural convection and forced convection, the supply water temperature must be controlled differently. Once a terminal unit is selected, the control varies the supply water temperature according to the

type of terminal unit. This improves the control of the air temperature in the building.

BOILER INDOOR DESIGN TEMPERATURE

The indoor design temperature is the room temperature that was used in the original heat loss calculations for the building. This setting establishes the beginning of the characterized heating curve, see Figure 15 below.

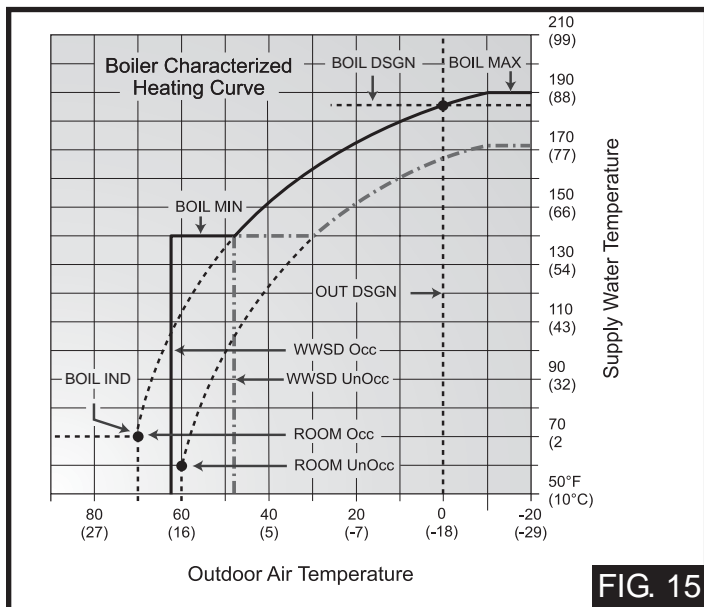

FIG. 15

OUTDOOR DESIGN TEMPERATURE

The outdoor design temperature is the outdoor air temperature that is the typical coldest temperature of the year where the building is located. This temperature is used when doing the heat loss calculations for the building. If a cold outdoor design temperature is selected, the boiler supply temperature rises gradually as the outdoor temperature drops. If a warm outdoor design temperature is selected, the boiler supply temperature rises rapidly as the outdoor temperature drops.

BOILER DESIGN TEMPERATURE

The design supply temperature is the supply water temperature required to heat the building when the outdoor air temperature is as cold as the outdoor design temperature.

WARM WEATHER SHUTDOWN

When the outdoor air temperature rises above the WWSD setting, the control turns on the WWSD pointer in the display. When the control is in Warm Weather Shut Down, the boiler demand pointer is displayed if there is a boiler demand. However, the control does not operate the heating system to satisfy this demand. The control does respond to a DHW or set point demand and operates as described in sections E & F.

ROOM

The room is the desired room temperature for the building and provides a parallel shift of the heating curve. The room temperature desired by the occupants is often different from the design indoor temperature. If the room temperature is not correct, adjusting the ROOM setting increases or decreases the amount of heat available to the building. A ROOM setting is available for both the occupied (day) and unoccupied (night) periods.

TERMINAL UNITS

The control provides for a selection between six different terminal unit types: two types of radiant floor heat, fancoil, fin-tube convactor, radiator and baseboard. When a terminal unit is selected, the control automatically loads the design supply temperature, maximum supply temperature, and minimum supply temperature (FIG. 16). The factory defaults are listed in Figure 16. These factory defaults can be changed to better match the installed system. If a factory default has been changed, refer to section A to reload the factory defaults.

TERMINAL UNIT	HIGH MASS RADIANT (1)	LOW MASS RADIANT (2)	FANCOIL (3)	FIN-TUBE CONVECTOR (4)	RADIATOR (5)	BASEBOARD (6)
BOIL DSGN	120°F (49°C)	140°F (60°C)	190°F (88°C)	180°F (82°C)	160°F (71°C)	150°F (66°C)
BOIL MAX	140°F (60°C)	160°F (71°C)	210°F (99°C)	200°F (93°C)	180°F (82°C)	170°F (77°C)
BOIL MIN	OFF	OFF	OFF	140°F (60°C)	140°F (60°C)	140°F (60°C)

FIG. 16

HIGH MASS RADIANT (1)

This type of a hydronic radiant floor is embedded in either a thick concrete or gypsumpour. This heating system has a large thermal mass and is slow acting (FIG. 17).

LOW MASS RADIANT (2)

This type of radiant heating system is either attached to the bottom of a wood sub-floor, suspended in the joist space, or sandwiched between the sub-floor and the surface. This type of radiant system has a relatively low thermal mass and responds faster than a high mass system (FIG. 17).

FANCOIL (3)

A fancoil terminal unit or air handling unit (AHU) consists of a hydronic heating coil and either a fan or blower. Air is forced across the coil at a constant velocity by the fan or blower, and is then delivered into the building space (FIG. 17).

FIN-TUBE CONVECTOR (4)

A convector terminal unit is made up of a heating element with fins on it. This type of terminal unit relies on the natural convection of air across the heating element to deliver heated air into the space. The amount of natural convection to the space is dependant on the supply water temperature to the heating element and the room air temperature (FIG. 17).

RADIATOR (5)

A radiator terminal unit has a large heated surface that is exposed to the room. A radiator provides heat to the room through radiant heat transfer and natural convection (FIG. 17).

BASEBOARD (6)

A baseboard terminal unit is similar to a radiator, but has a low profile and is installed at the base of the wall. The proportion of heat transferred by radiation from a baseboard is greater than that from a fin-tube convector (FIG. 17).

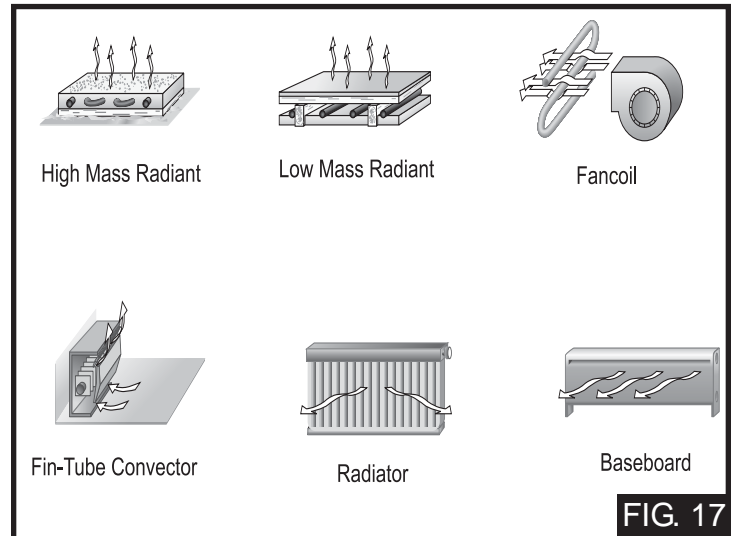

FIG. 17

BOOST

When the control changes from the UnOccupied mode to the Occupied mode, it enters into a boosting mode. In this mode, the supply water temperature to the system is raised above its normal values for a period of time to provide a faster recovery from the setback temperature of the building. The maximum length of the boost is selected using the BST setting.

Typical settings for the boost function vary between 30 minutes and two hours for buildings that have a fast responding heating system. For buildings that have a slow responding heating system, a setting between four hours and eight hours is typical. After a boost time is selected, the setback timer must be adjusted to come out of setback some time in advance of the desired occupied time. This time in advance is normally the same as the BST setting.

If the building is not up to temperature at the correct time, the BST setting should be lengthened and the setback timer should be adjusted accordingly. If the building is up to temperature before the required time, the BST setting should be shortened and the setback timer should be adjusted accordingly. If the system is operating near its design conditions or if the supply water temperature is being limited by settings made in the control, the time required to bring the building up to temperature may be longer than expected.

SECTION E: DOMESTIC HOT WATER OPERATION

SECTION E1: DOMESTIC HOT WATER (DHW)

DHW DEMAND

A DHW Demand is required for the control to provide heat to the DHW system. A DHW aquastat or set point control is used as a switch in the DHW demand circuit. Once the control detects a DHW demand, the DHW Demand pointer turns on in the LCD and the control operates the boiler to provide a sufficient boiler supply water temperature to the DHW tank. The control operates the pumps as described below.

The control registers a DHW Demand when a voltage between 24 and 230 V (ac) is applied across the Setp / DHW and Com Dem terminals (8 and 7).

BOILER TARGET DURING DHW GENERATION

The boiler target temperature is at least as hot as the DHW exchange setting (DHW XCHG). The DHW demand overrides the boiler reset target temperature, except when the boiler reset target is higher than that of the DHW exchange setting.

DHW MODE & PRIORITY OPERATION

The control has five different settings available for DHW MODE. The required DHW MODE setting will depend on the piping arrangement of the DHW tank.

It is often desirable to have a priority for the DHW allowing for quick recovery of the DHW tank temperature. This is achieved by limiting or even stopping the flow of heat to the heating system when the DHW tank calls for heat see Figure 18.

DHW MODE OFF - No DHW

The DHW feature is not selected. This allows for Set Point operation as described in section F.

DHW MODE 1 - DHW IN PARALLEL NO PRIORITY

When a DHW Demand is present, the Relay 9 / DHW contact (terminals 30 and 31) closes and the primary pump contact is opened. **It is assumed that the DHW pump will provide adequate flow through the heat exchanger and the boiler.**

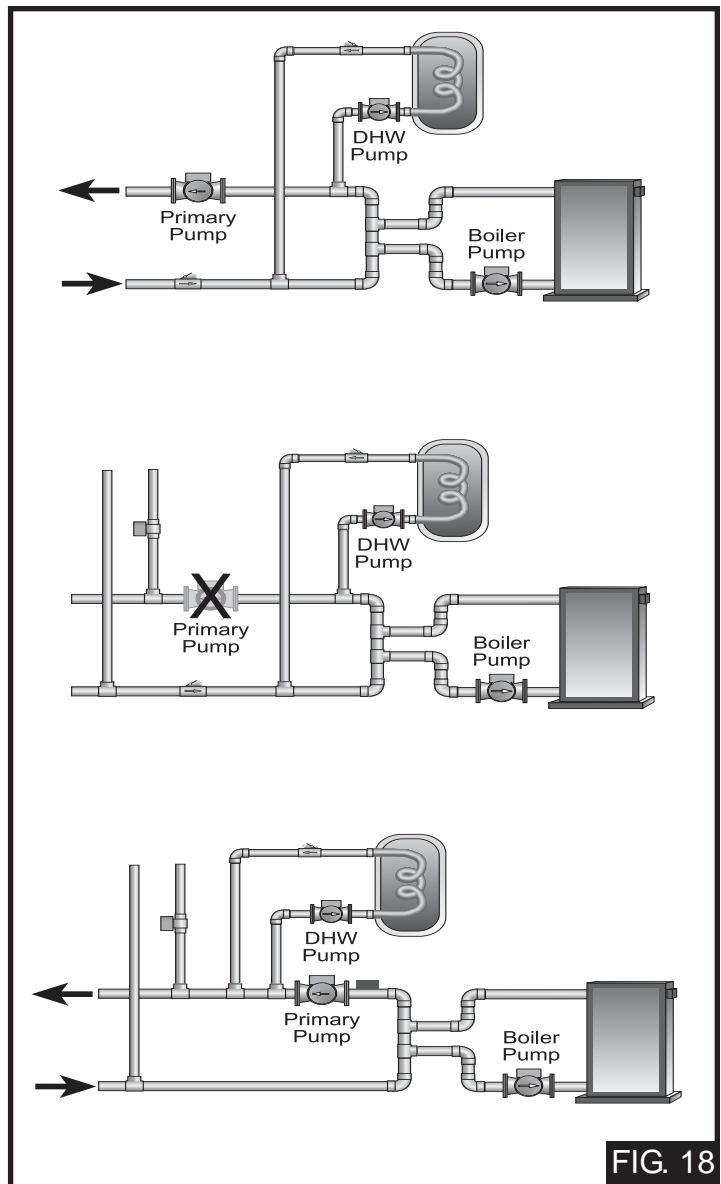

DHW MODE 2 - DHW IN PARALLEL NO PRIORITY

When a DHW Demand is present, the Relay 9 / DHW contact (terminals 30 and 31) closes with the DHW demand. The primary pump does not turn on, but may operate based on a Boiler Demand or External Input Signal. Refer to sections E and G. **It is assumed that the DHW pump will provide adequate flow through the heat exchanger and the boiler.**

DHW MODE 3 - DHW IN PRIMARY / SECONDARY NO PRIORITY

When a DHW Demand is present, the Relay 9 / DHW contact (terminals 30 and 31) is closed and the primary pump contact is closed. **This mode can be used if a DHW tank is piped in direct return and a DHW valve is installed.**

DHW MODE 4 - DHW IN PRIMARY / SECONDARY WITH PRIORITY

When a DHW Demand is present, the Relay 9 / DHW contact (terminals 30 and 31) is closed and the primary pump contact is closed. Priority can only be obtained using external wiring. During a priority override, the Relay 9 / DHW contact is opened until the heating system has recovered before returning to DHW operation, see Figure 19. **This mode can be used if a DHW tank is piped in direct return and a DHW valve is installed.**

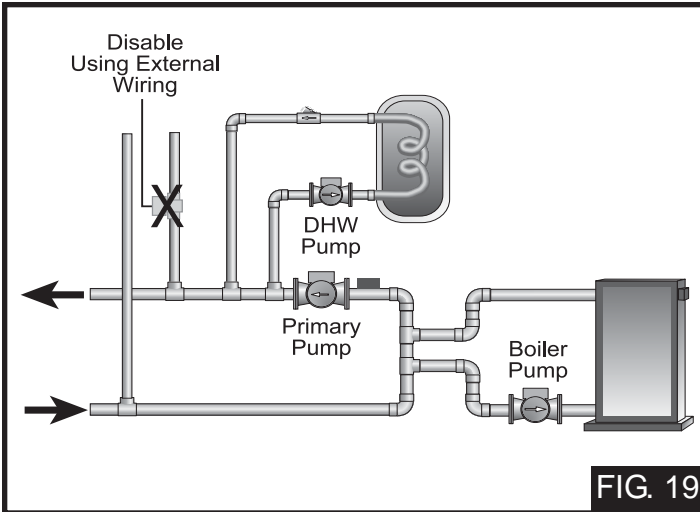

DHW PRIORITY OVERRIDE

The DHW Priority Override applies to DHW MODE 2 and 4. To prevent the building from cooling off too much or the possibility of a potential freeze up during DHW priority, the control limits the amount of time for DHW priority. The length of DHW priority time is determined using the Priority Override setting. Once the allowed time for priority has elapsed, the control overrides the DHW priority and resumes space heating.

To provide external DHW priority in DHW Mode 4, the space heating zones must be interlocked with the Relay 9 / DHW contact, Figure 20. During DHW demands, the Relay 9 / DHW contact must remove any power to all space heating zone valves or zone pumps.

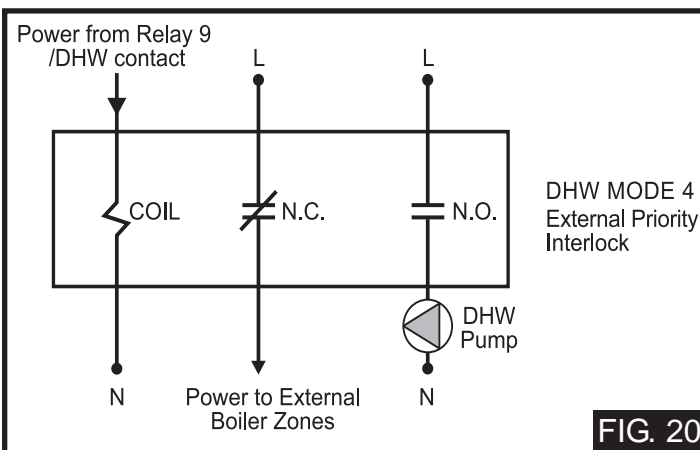

CONDITIONAL DHW PRIORITY

The Conditional DHW Priority Override applies to DHW MODE 2 and 4. If the boiler supply temperature is maintained at or above the required temperature during DHW generation, this indicates that the boiler(s) has enough capacity for DHW and possibly heating as well. As long as the boiler supply temperature is maintained near its target and the heating and DHW targets are similar, DHW and heating occurs simultaneously.

DHW POST PURGE

After the DHW Demand is removed, the control performs a purge on the boiler(s). The control shuts off the boiler(s) and continues to operate either the DHW pump or the DHW valve and the system and boiler pump if applicable. This purges the residual heat from the boiler(s) into the DHW tank. The control continues this purge for a maximum of two minutes or until the boiler supply water temperature drops 20° F (11°C) below the boiler target temperature during the DHW operation. The control also stops the purge if the boiler supply temperature is close to the current boiler target temperature.

DHW MIXING PURGE

After DHW operation, the boiler(s) is extremely hot. At the same time, the heating zones may have cooled off considerably after being off for a period of time. To avoid thermal-shocking the boiler(s) after DHW in parallel with priority (DHW MODE 2), the control shuts off the boiler(s), but continues to operate the DHW while restarting the heating system. This allows some of the DHW return water to mix with the cool return water from the zones and temper the boiler return water (FIG. 21).

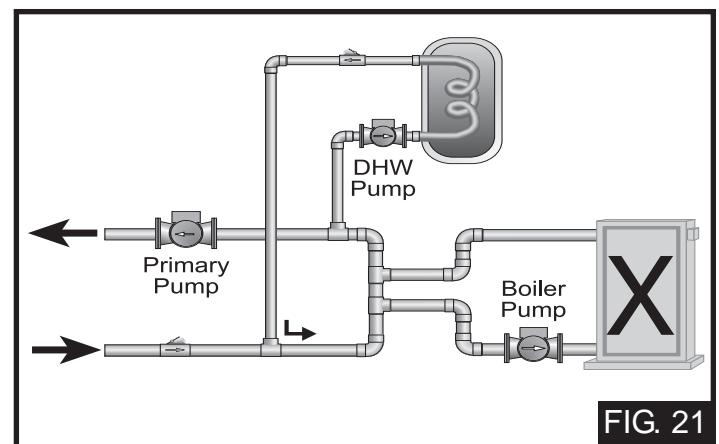

DHW DURING UNOCCUPIED

If the control receives a DHW Demand during an unoccupied period, the control can either continue operation of the DHW system as it would during the occupied period or the control can ignore a DHW Demand for the duration of the unoccupied period.

NUMBER OF BOILERS USED FOR DHW GENERATION

The number of boilers used for DHW generation can be selected from one to the maximum number of boilers using the BOIL DHW setting. This applies when only a DHW Demand is present. If there are other demands present, the control does not limit the number of boilers operated.

SECTION E2: DHW WITH LOW TEMPERATURE BOILERS

If DHW is to be incorporated into a low temperature system such as a radiant heating system, a mixing device is often installed to isolate the high DHW supply temperature from the lower system temperature. If a mixing device is not installed, high temperature water could be supplied to the low temperature system while trying to satisfy the DHW demand. This may result in damage to the low temperature heating system. The control is capable of providing DHW in such a system while maximizing the chance that the temperature in the heating system does not exceed its allowed maximum setting.

To prevent high temperature water from being introduced into the heating system, the primary pump (Prim P1) must be turned off during a call for DHW. To do this, the control must be set to DHW MODE 2 or DHW MODE 4 and Boil MIN must be set to OFF, see Figure 22 below.

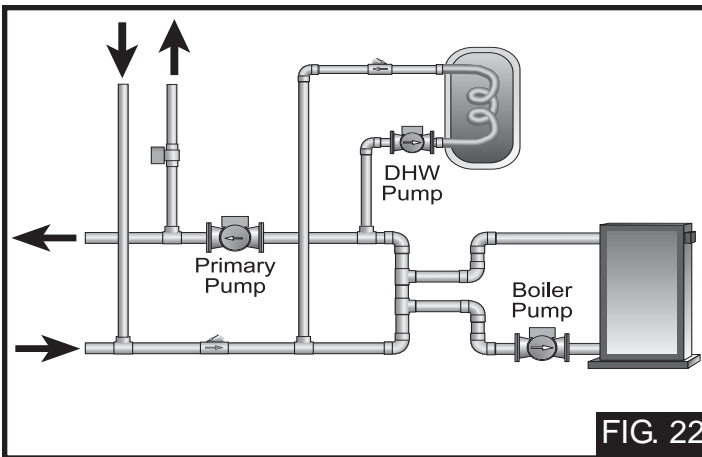

DHW MODE 2 OPERATION

On a call for DHW, the control provides DHW priority by shutting off the primary pump (Prim P1) for a period of time. This time is based on the DHW Priority Override setting. However, if the DHW Demand is not satisfied within the allotted time, the boiler(s) shuts off and the heat of the boiler is purged into the DHW tank.

Once the boiler supply temperature is sufficiently reduced, the Relay 9 / DHW contact shuts off. The heating system is turned on for a period of time to prevent the building from cooling off. After a period of heating, and if the DHW Demand is still present, the control shuts off the heating system and provides heat to the DHW tank once again.

For correct operation, close attention must be paid to the mechanical layout of the system. When the control turns off the primary pump (Prim P1), flow to the heating system must stop. If flow is not stopped, the temperature in the heating system can exceed the maximum desired temperature and can result in damage to the heating system.

DHW MODE 4 OPERATION

In DHW MODE 4, the space heating zones must be prevented from coming on during DHW demands using external wiring. This can be done using an external relay to remove power from zone pumps or zone valves while a DHW Demand is present. During a DHW Demand, the control closes the primary pump (Prim P1) contact and the Relay 9 / DHW contact. Once the DHW Demand is removed, or during a DHW Priority Override, the Relay 9 / DHW contact is opened, and the external wiring should allow the space heating zones to operate.

There is no mixing purge available in DHW MODE 4. After DHW priority, the boiler supply water temperature may exceed the design water temperature of the space heating system and can result in damage to the heating system.

SECTION F: SET POINT OPERATION

SECTION F1: SET POINT

Set point operation is only available when DHW MODE is set to OFF.

SET POINT

The control can operate to satisfy the requirements of a set point load in addition to a space heating load. A set point load overrides the current outdoor reset temperature and WWSD setting in order to provide heat to the set point load.

SET POINT DEMAND

A set point demand is required for the control to provide heat to the set point load. The control registers a set point demand when a voltage between 24 and 230 V (ac) is applied across the Setp / DHW and Com Dem terminals (8 and 7) (FIG. 23).

Once voltage is applied, the Set Point Demand pointer turns on in the LCD. The control operates the boiler(s) to maintain at least the set point setting.

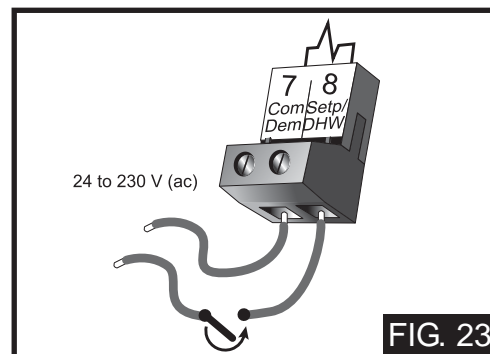

BOILER TARGET DURING SET POINT

The boiler target temperature during a set point demand is increased to at least the Set Point setting. This temperature is maintained as long as the control has a set point demand.

SET POINT MODE

SETP MODE 1 - Setpoint in Parallel

Whenever a set point demand is present, the boiler(s) is operated to maintain the set point target. The primary pump does not turn on, but may operate based on a Boiler Demand or an External Input Signal, see Figure 24.

It is assumed that the Set Point pump will provide adequate flow through the heat exchanger and the boiler.

SETP MODE 2 - Set Point in Parallel with Priority

Whenever a set point demand is present, the boiler(s) is operated to maintain the set point target and the primary pump (Prim P1) contact is opened.

It is assumed that the Set Point pump will provide adequate flow through the heat exchanger and the boiler.

SETP MODE 3 - Primary Pump during Set Point

Whenever a set point demand is present, the primary pump (Prim P1) is turned on and the boiler(s) is operated to maintain the set point target.

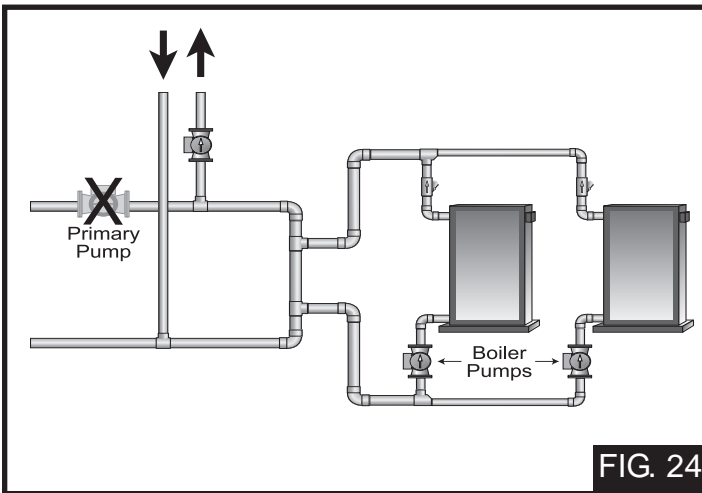

SET POINT PRIORITY OVERRIDE

The set point has a Priority Override while in SETP MODE 2. In order to prevent the building from cooling off too much or the possibility of a potential freeze up during set point priority, the control limits the amount of time for set point priority. The length of Set Point priority is determined by the Priority Override setting. Once the allowed time for priority has elapsed, the control overrides the set point priority and

operates set point and heating simultaneously by turning on the primary pump (Prim P1).

CONDITIONAL SET POINT PRIORITY

If the boiler(s) supply temperature is maintained at or above the required temperature during set point generation, this indicates that the boiler(s) has enough capacity for set point and possibly heating as well. As long as the boiler target temperature is maintained and the heating and set point targets are similar, set point and heating occur at the same time.

SECTION G: EXTERNAL INPUT OPERATION

SECTION G1: EXTERNAL INPUT

EXTERNAL INPUT

The control can accept an external DC signal in place of the outdoor sensor. The control converts the DC signal into the appropriate boiler target temperature between 50°F (10°C) and 210°F (99°C) based on the External Input Signal and Offset settings. To use the external input signal, the External Input / Stand Alone DIP switch must be set to External Input.

When operating in the external input mode, an external signal is required in order for the control to provide heat to the heating system. An external signal is generated by applying a voltage between 0 V (dc) and 10 V (dc) across the Out + and Com - terminals (4 and 1) (FIG. 25). Once voltage is applied, the External Input Signal pointer is displayed in the LCD and the control closes the primary pump contact. The control calculates a boiler target supply temperature based on the external input signal and the settings made in the control. The control then fires the boiler(s), if required, to maintain the target supply temperature. If the external signal goes below the minimum voltage, the External Input Signal pointer is turned off in the display. The boiler target temperature is displayed as " - - - " to indicate that there is no longer a call for heating. The primary pump and boiler pumps operate as described in section C.

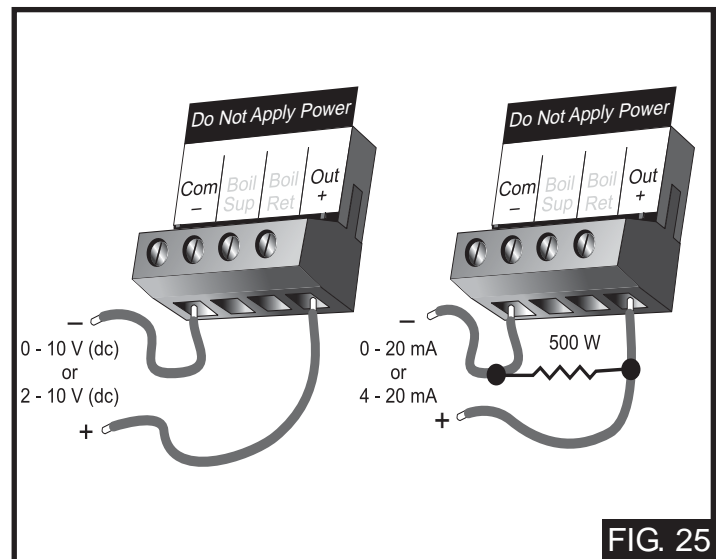

INPUT SIGNAL

The control can accept either a 0 - 10 V (dc) signal or a 2 - 10 V (dc) signal. The *External Input Signal* setting must be set to the proper setting based on the signal that is being sent to the control.

0 - 10 V (dc) or 0 - 20 mA

When the 0 - 10 V (dc) signal is selected, an input voltage of 1 V (dc) corresponds to a boiler target temperature of 50°F (10°C). An input voltage of 10 V (dc) corresponds to a boiler target temperature of 210°F (99°C). As the voltage varies between 1 V (dc) and 10 V (dc) the boiler target temperature varies linearly between 50°F (10°C) and 210°F (99°C). If a voltage below 0.5 V (dc) is received the boiler target temperature is displayed as " - - - " indicating that there is no longer a call for heating.

A 0 - 20 mA signal can be converted to a 0 - 10 V (dc) signal by installing a 500 ohm resistor between the Out + and Com - terminals (4 and 1).

2 - 10 V (dc) or 4 - 20 mA

When the 2 - 10 V (dc) signal is selected, an input voltage of 2 V (dc) corresponds to a boiler target temperature of 50°F (10°C). An input voltage of 10 V (dc) corresponds to a boiler target temperature of 210°F (99°C). As the voltage varies between 2 V (dc) and 10 V (dc) the boiler target temperature varies linearly between 50°F (10°C) and 210°F (99°C). If a voltage below 1.5 V (dc) is received the boiler target temperature is displayed as " - - - " indicating that there is no longer a call for heating.

A 4 - 20 mA signal can be converted to a 2 - 10 V (dc) signal by installing a 500 ohm resistor between the Out + and Com - terminals (4 and 1).

OFFSET

The *Offset* setting allows the boiler target temperature to be fine tuned to the external input signal. The control reads the external input signal and converts this to a boiler target temperature. The Offset setting is then added to the boiler target temperature.

EXTERNAL INPUT SIGNAL CONVERSION TABLES

CONVERSION TABLE 0 - 10		
0 - 20 mA*	0 - 10 V (dc)	Boiler Target
0	0	---(OFF)
2	1	50°F (10°C)
4	2	68°F (20°C)
6	3	86°F (30°C)
8	4	103°F (39°C)
10	5	121°F (49°C)
12	6	139°F (59°C)
14	7	157°F (69°C)
16	8	174°F (79°C)
18	9	192°F (89°C)
20	10	210°F (99°C)

*Requires 500 Ω Resistor in Parallel

CONVERSION TABLE 2 - 10		
4 - 20 mA*	2 - 10 V (dc)	Boiler Target
0	0	---(OFF)
4	2	50°F (10°C)
6	3	70°F (21°C)
8	4	90°F (32°C)
10	5	110°F (43°C)
12	6	130°F (54°C)
14	7	150°F (66°C)
16	8	170°F (77°C)
18	9	190°F (88°C)
20	10	210°F (99°C)

*Requires 500 Ω Resistor in Parallel

Example	Range = 0 - 10 V (dc)	
	Input = 7 V (dc)	
	Offset = +5°F (3°C)	
	Boiler Target =	157°F (69°C) +5°F (3°C) ----- 162°F (72°C)

INSTALLATION

⚠ CAUTION

Improper installation and operation of this control could result in damage to the equipment and possibly even personal injury. It is your responsibility to ensure that this control is safely installed according to all applicable codes and standards. This electronic control is not intended for uses as a primary limit control. Other controls that are intended and certified as safety limits must be placed into the control circuit. Do not open the control. Refer to qualified personnel for servicing. Opening voids warranty and could result in damage to the equipment and possibly even personal injury.

STEP ONE ----- GETTING READY

Check the contents of this package. If any of the contents listed are missing or damaged, please contact your wholesaler or Lochinvar sales representative for assistance.

MP² includes: One Boiler Control MP², One Outdoor Sensor TST2311, Two Temperature Sensors TST2313, Instruction Manuals INS7141 and INS7162

Note: Carefully read the details of the Sequence of Operation to ensure that you have chosen the proper control for your application.

⚠ STEP TWO ---- ROUGH-IN WIRING

All electrical wiring terminates in the control base wiring chamber. The base has standard 7/8" (22 mm) knockouts which accept common wiring hardware and conduit fittings. Before removing the knockouts, check the wiring diagram and select those sections of the chamber with common voltages. Do not allow the wiring to cross between sections as the wires will interfere with safety dividers which should be installed at a later time.

Power must not be applied to any of the wires during the rough-in wiring stage.

- All wires are to be stripped to a length of 3/8" (9 mm) to ensure proper connection to the control.

- If an Outdoor Sensor TST2311 is used, install the sensor according to the installation instructions in the INS7141 and run the wiring back to the control.

- Install the TST2311 sensor according to the installation instructions in the Data Brochure D 070 and run the wiring back to the control.

- If a TST2311 sensor is used, install the sensor according to the installation instructions in the Data Brochure D 070 and run the wiring back to the control.

- Run wire from other system components (pumps, boilers, etc.) to the control.

- Run wires from the 115 V (ac) power to the control. Use a clean power source with a 15 A circuit to ensure proper operation. Multi-strand 16 AWG wire is recommended for all 115 V (ac) wiring due to its superior flexibility and ease of installation into the terminals.

STEP THREE ----- ELECTRICAL CONNECTIONS TO THE CONTROL

General

The installer should test to confirm that no voltage is present at any of the wires. Push the control into the base and slide it down until it snaps firmly into place.

POWERED INPUT CONNECTIONS

115 V (ac) Power

Connect the 115 V (ac) power supply to the Power L and Power N terminals (10 and 9) (FIG. 26). This connection provides power to the microprocessor and display of the control. As well, this connection provides power to the Prim P1 terminal (11) from the Power L terminal (10).

Boiler Demand

To generate a boiler demand, a voltage between 24 V (ac) and 230 V (ac) must be applied across the Boil Dem and Com Dem terminals (6 and 7) (FIG. 26).

DHW Demand

To generate a DHW Demand, a voltage between 24 V (ac) and 230 V (ac) must be applied across the Setp / DHW and Com Dem terminals (8 and 7) (FIG. 26). If using DHW, the last boiler in MODE 1, 4 or 5 must be set to OFF and DHW MODE must also be set to 1 through 4.

Set Point Demand

To generate a setpoint demand, a voltage between 24 V (ac) and 230 V (ac) must be applied across the Setp / DHW and Com Dem terminals (8 and 7) (FIG. 26). The DHW MODE must be set to OFF.

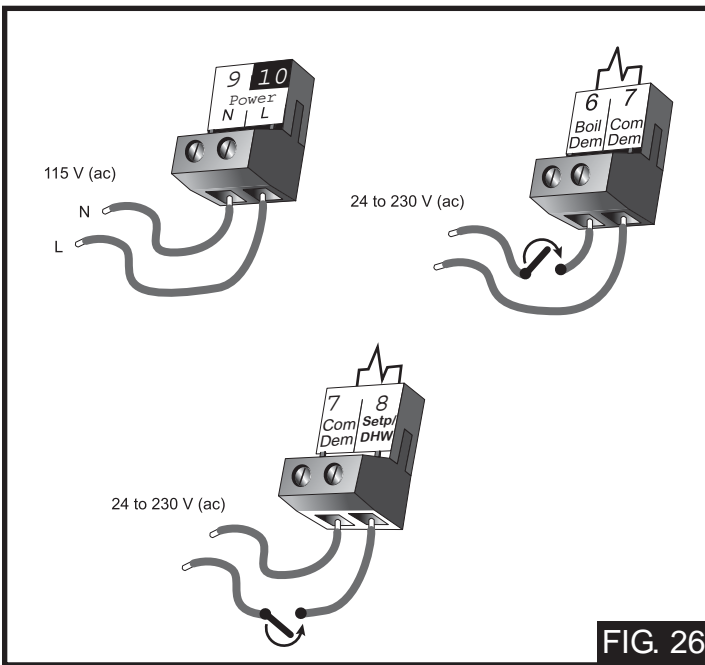

FIG. 26

External Input (0 - 10 V dc)

To generate an external input signal, a voltage between 0 and 10 V (dc) must be applied to the Com - and Out + terminals (1 and 4) (FIG. 27).

A 0 - 20 mA signal can be converted to a 0 - 10 V (dc) signal by installing a 500 ohm resistor between the Com - and Out + terminals (1 and 4) (FIG. 27).

A 4 - 20 mA signal can be converted to a 2 - 10 V (dc) signal by installing a 500 ohm resistor between the Com - and Out + terminals (1 and 4) (FIG. 27).

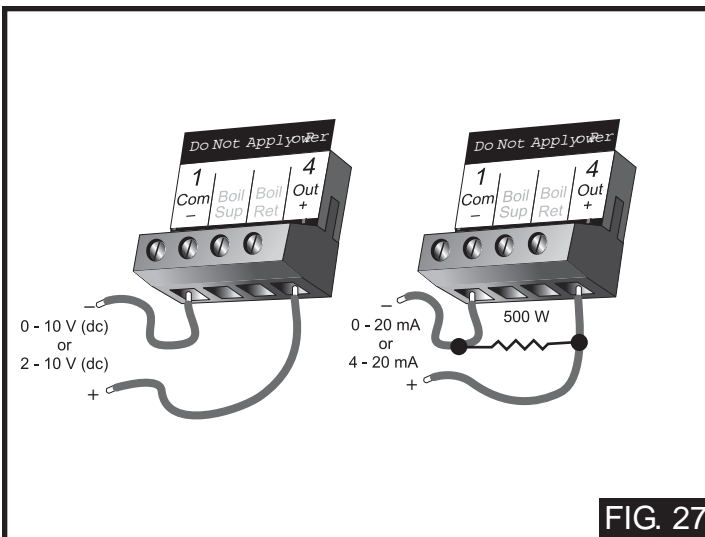

FIG. 27

OUTPUT CONNECTIONS

Primary Pump Contact (Prim P1)

The Prim P1 output terminal (11) is a powered output. When the relay in the control closes, 115 V (ac) is provided to the Prim P1 terminal (11) from the Power L terminal (10). To operate the primary pump, connect one side of the primary pump circuit to terminal 11 and the second side of the pump circuit to the neutral (N) side of the 115 V (ac) power supply, see Figure 28.

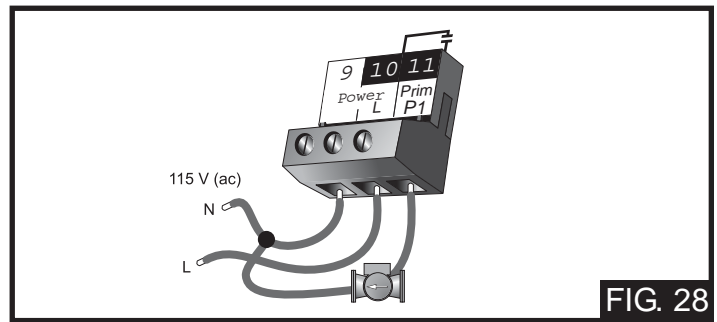

FIG. 28

Combustion Air / Alarm Contact (C.A./Alarm)

The Combustion Air / Alarm Contact (C.A./Alarm) terminals (12 and 13) (FIG. 29) are an isolated output in the control. There is no power available on these terminals from the control. These terminals are to be used as a switch to either make or break power to the combustion air damper or alarm. Since this is an isolated contact, it may switch a voltage between 24 V (ac) and 230 V (ac).

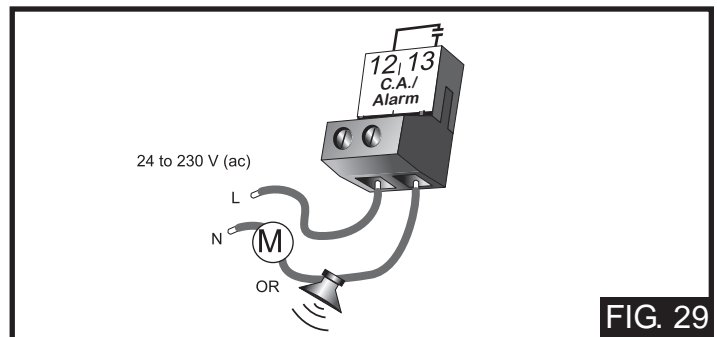
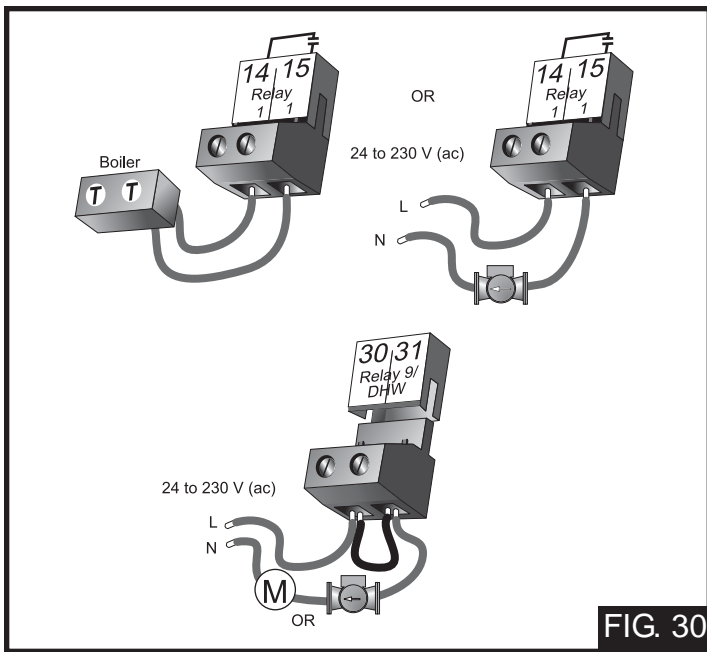

FIG. 29

Relay 1 to Relay 9

The Relay 1 to Relay 9 terminals (14 and 15 to 30 and 31) (FIG. 30) are isolated outputs in the control. There is no power available on these terminals from the control. These terminals are to be used as a switch to either make or break power to a boiler stage or a boiler pump. Since this is an isolated contact, it may switch a voltage between 24 V (ac) and 230 V (ac).



Relay 9 / DHW

If a DHW pump or DHW valve is connected to the Relay 9 / DHW contact (30 and 31) (FIG. 30), make sure the power to the pump or valve circuit is off and install a jumper between those terminals. When the DHW circuit is powered up, the DHW pump should turn on or the DHW valve should open completely. If the DHW pump or valve fails to operate, check the wiring between the terminals and the pump or valve and refer to any installation or troubleshooting information supplied with these devices. If the DHW pump or valve operates correctly, disconnect the power and remove the jumper.

⚠ SENSOR AND UNPOWERED INPUT CONNECTIONS

Do not apply power to these terminals as this will damage the control.

Outdoor Sensor

If an outdoor sensor is used, connect the two wires from the Outdoor Sensor TST2311 to the Com - and Out + terminals (1 and 4) (FIG. 31). The outdoor sensor is used by the control to measure the outdoor air temperature.

Boiler Supply Sensor

Connect the two wires from the TST2311 sensor to the Com - and Boil Sup terminals (1 and 2) (FIG. 31). The boiler supply sensor is used by the control to measure the boiler supply water temperature.

Boiler Return Sensor

If a boiler return sensor is used, connect the two wires from the TST2311 sensor to the Com - and Boil Ret terminals (1 and 3) (FIG. 31). The boiler return sensor is used by the control to measure the boiler return water temperature.

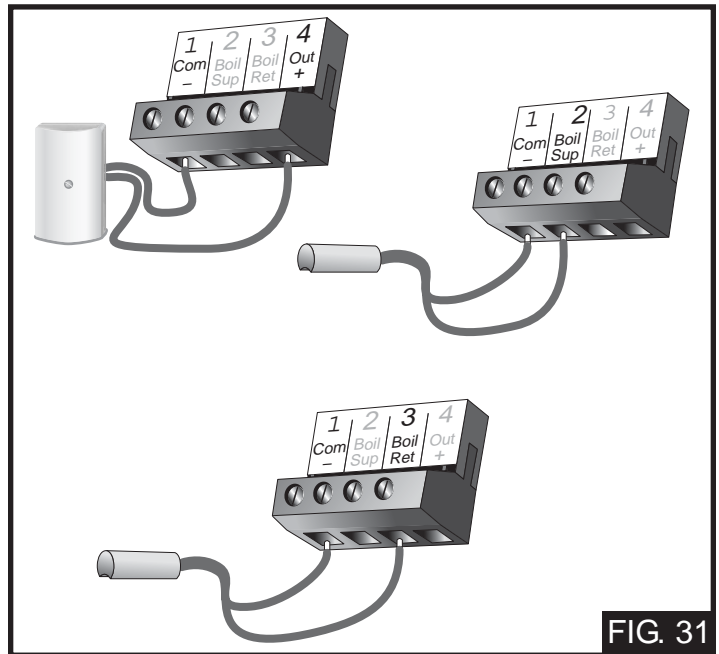

Unoccupied Switch

If an external timer or switch is used, connect the two wires from the external switch to the Com - and UnO Sw terminals (1 and 5) (FIG. 32). When these two terminals are shorted together, the control registers an UnOccupied signal.

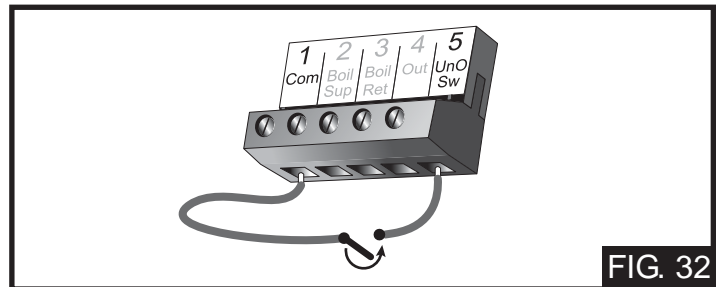

STEP FOUR ----- TESTING THE WIRING

⚠ GENERAL

Each terminal block must be unplugged from its header on the control before power is applied for testing. To remove the terminal block, pull straight down from the control.

The following tests are to be performed using standard testing practices and procedures and should only be carried out by properly trained and experienced persons.

A good quality electrical test meter, capable of reading from at least 0 - 300 V (ac) and at least 0 - 2,000,000 ohm, is essential to properly test the wiring and sensors.

⚠ TEST THE SENSORS

In order to test the sensors, the actual temperature at each sensor location must be measured. A good quality digital thermometer with a surface temperature probe is recommended for ease of use and accuracy (FIG. 33). Where a digital thermometer is not available, a spare sensor can be strapped alongside the one to be tested and the readings compared. Test the sensors according to the instructions in INS7141.

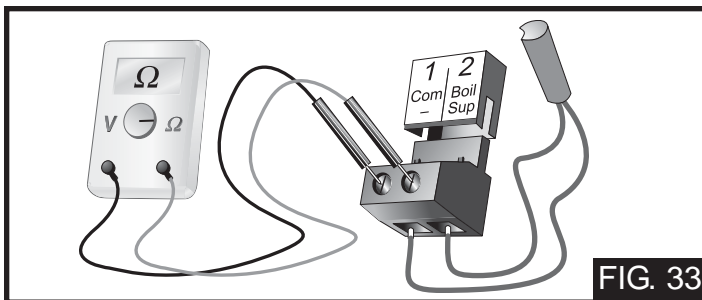

FIG. 33

TEST THE POWER SUPPLY

Make sure exposed wires and bare terminals are not in contact with other wires or grounded surfaces. Turn on the power and measure the voltage between the Power L and Power N terminals (10 and 9) (FIG. 34) using an AC voltmeter, the reading should be between 103.5 and 126.5 V (ac).

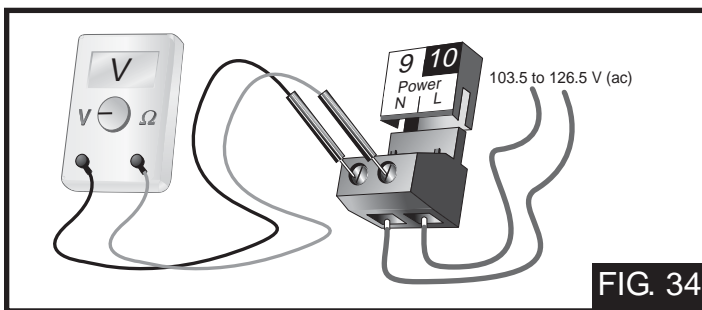

FIG. 34

⚠ TEST THE POWERED INPUTS

Boiler Demand

If a boiler demand is used, measure the voltage between the Boil Dem and the Com Dem terminals (6 and 7) (FIG. 35). When the boiler demand device calls for heat, you should measure between 20 and 260 V (ac) at the terminals. When the boiler demand device is off, you should measure less than 5 V (ac).

DHW Demand

If a DHW demand is used, measure the voltage between the Setp / DHW and the Com Dem terminals (8 and 7) (FIG. 35). When the DHW demand device calls for heat, a voltage between 20 and 260 V (ac) should be measured at the terminals. When the DHW demand device is off, less than 5 V (ac) should be measured.

Set Point Demand

If a set point demand is used, measure the voltage between the Setp / DHW and the Com Dem terminals (8 and 7) (FIG. 35). When the set point demand device calls for heat, you should measure between 20 and 260 V (ac) at the terminals. When the set point demand device is off, you should measure less than 5 V (ac).

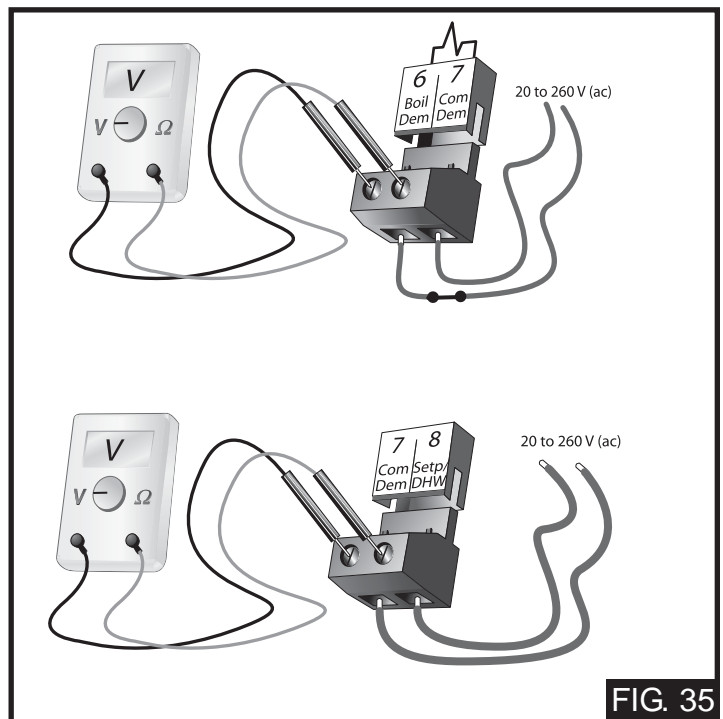

FIG. 35

External Input

If an external input is used, measure the voltage between the Com - and the Out + terminals (1 and 4). When the external input device calls for heat, you should measure between 0 and 10 V (dc) at the terminals.

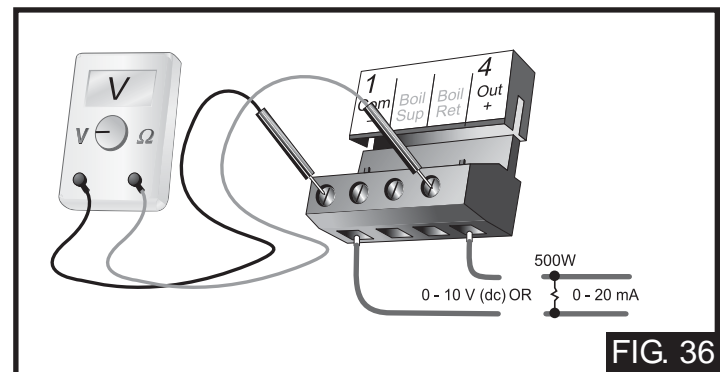
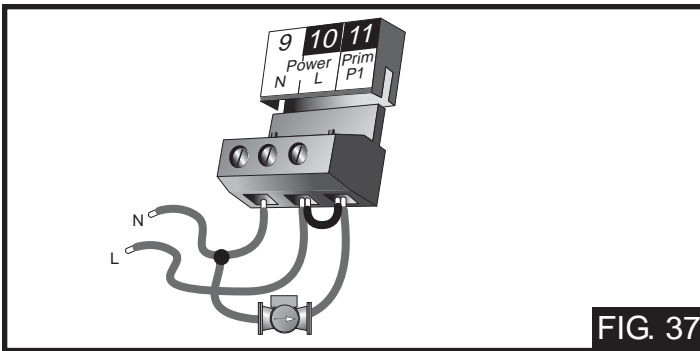

FIG. 36

⚠ TEST THE OUTPUTS

Primary Pump (Prim P1)

If a primary pump is connected to the Prim P1 terminal (11), make sure that power to the terminal block is off and install a jumper between the Power L and Prim P1 terminals (10 and 11) (FIG. 37). When power is applied to the Power N and Power L terminals (9 and 10) (FIG. 37), the primary pump should start. If the pump does not turn on, check the wiring between the terminal block and pump and refer to any installation or troubleshooting information supplied with the pump. If the pump operates properly, disconnect the power and remove the jumper.



Combustion Air or Alarm (C.A. / Alarm)

If a combustion air damper or an alarm is connected to the C.A. / Alarm terminals (12 and 13), make sure power to the damper or alarm circuit is off and install a jumper between terminals (12 and 13) (FIG. 38). When the circuit is powered up, the combustion air damper should open or the alarm should activate. If the damper or the alarm fails to operate, check the wiring between the terminals and the damper or the alarm and refer to any installation or troubleshooting information supplied with these devices. If the damper or the alarm operates properly, disconnect the power and remove the jumper.

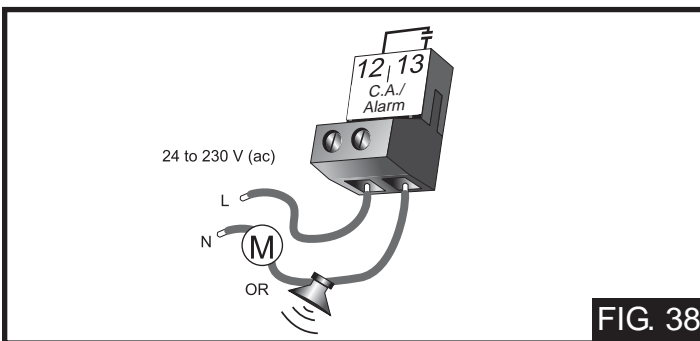

Relay 1 to Relay 9

If a boiler stage is connected to the Relay 1 terminals (14 and 15) (FIG. 39), make sure power to the boiler circuit is off, and install a jumper between the terminals. When the boiler circuit is powered up, the boiler should fire. If the boiler does not turn on, refer to any installation or trou-

bleshooting information supplied with the boiler. (The boiler may have a flow switch that prevents firing until the primary pump (P1) or boiler pump is running.) If the boiler operates properly, disconnect the power and remove the jumper.

If a boiler pump is connected to the Relay 1 terminals (14 and 15) (FIG. 39), make sure that power to the terminal block is off and install a jumper between the terminals. When power is applied to the circuit, the boiler pump should start. If the pump does not turn on, check the wiring between the terminal block and pump and refer to any installation or troubleshooting information supplied with the pump. If the pump operates properly, disconnect the power and remove the jumper. Repeat the above procedure for Relay 2 to Relay 9.

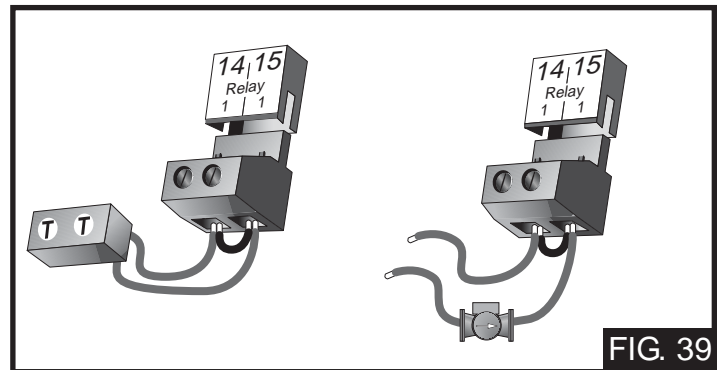

Relay 9 / DHW

If a DHW pump or DHW valve is connected to the Relay 9 / DHW contact (30 and 31) (FIG. 40), make sure the power to the pump or valve circuit is off and install a jumper between those terminals. When the DHW circuit is powered up, the DHW pump should turn on or the DHW valve should open completely. If the DHW pump or valve fails to operate, check the wiring between the terminals and the pump or valve and refer to any installation or troubleshooting information supplied with these devices. If the DHW pump or valve operates correctly, disconnect the power and remove the jumper.

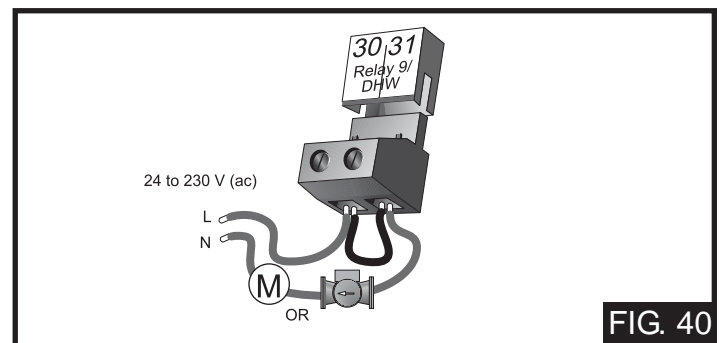

△ CONNECTING THE CONTROL

Make sure all power to the devices and terminal blocks is off, and remove any remaining jumpers from the terminals.

Reconnect the terminal blocks to the control by carefully aligning them with their respective headers on the control, and then pushing the terminal blocks into the headers. The terminal blocks should snap firmly into place, see Figure 41.

Install the supplied safety dividers between the unpowered sensor inputs and the powered or 115 V (ac) wiring chambers.

Apply power to the control. The operation of the control on power up is described in the Sequence of Operation section of this instruction manual.

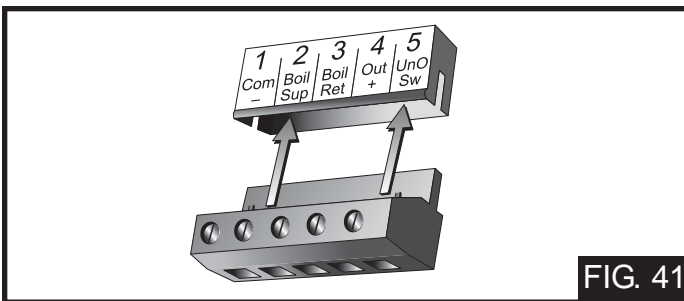

FIG. 41

CLEANING THE CONTROL

The control's exterior can be cleaned using a damp cloth. Moisten the cloth with water and wring out prior to wiping the control. Do not use solvents or cleaning solutions.

DIP SWITCH SETTINGS

GENERAL

The DIP switch settings on the control are very important and should be set to the appropriate settings prior to making any adjustments to the control through the User Interface. The DIP switch settings change the items that are available to be viewed and / or adjusted in the User Interface.

If a DIP switch is changed while the control is powered up, the control responds to the change in setting by returning the display to the VIEW menu, see Figure 42.

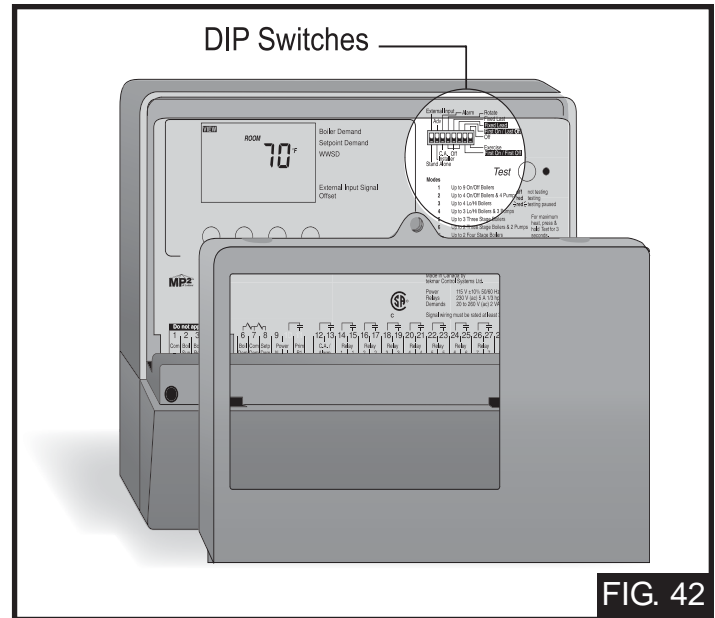

FIG. 42

EXTERNAL INPUT / STAND ALONE

The External Input / Stand Alone DIP switch selects whether a Lochinvar Outdoor Sensor TST2311 or an external 0 - 10 V (dc) input signal is to be connected to the Com - and the Out + terminals (1 and 4) (FIG. 43).

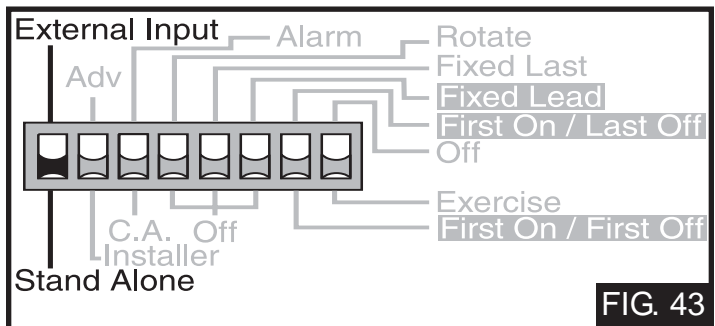

FIG. 43

ADVANCED / INSTALLER

The Adv / Installer DIP switch selects the access level of the control (FIG. 44). In the Installer access level, a limited number of items may be viewed and / or adjusted. In the Advanced access level, all items may be viewed and / or adjusted.

ALARM / COMBUSTION AIR

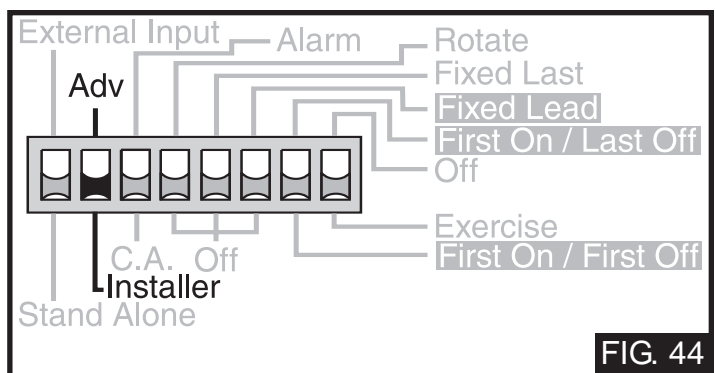
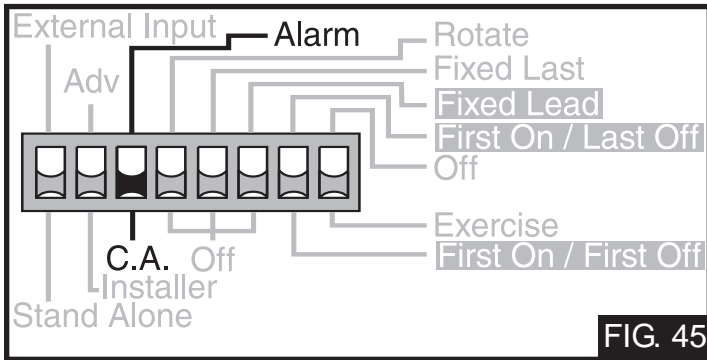

FIG. 44

The Alarm / C.A. DIP switch selects whether a combustion air damper or alarm device is to be connected to the C.A. / Alarm terminals (12 and 13) (FIG. 45).

ROTATE / OFF



The Rotate / Off DIP switch selects whether or not the control is to provide Equal Run Time Rotation of the boiler stages. If the switch is set to Rotate, the stages will be rotated accordingly. If the switch is set to Off, the firing sequence is fixed starting with the lowest stage to the highest stage (FIG. 46).

FIXED LAST / OFF

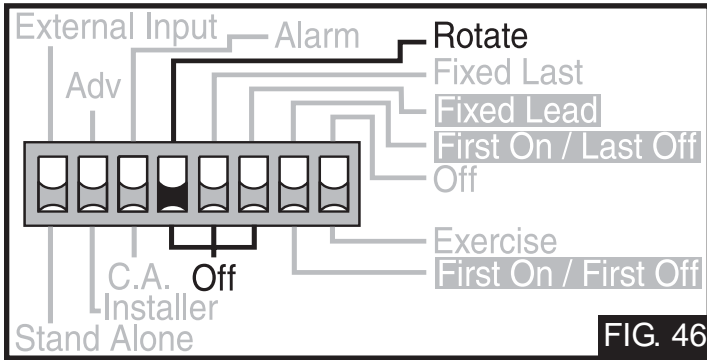

The Fixed Last / Off DIP switch selects whether or not the last boiler is to be included in the rotation sequence. If the DIP switch is set to Fixed Last, the last boiler is always the last to fire (FIG. 47). This DIP switch is only active when the Rotate / Off DIP switch is set to Rotate.

FIXED LEAD / OFF

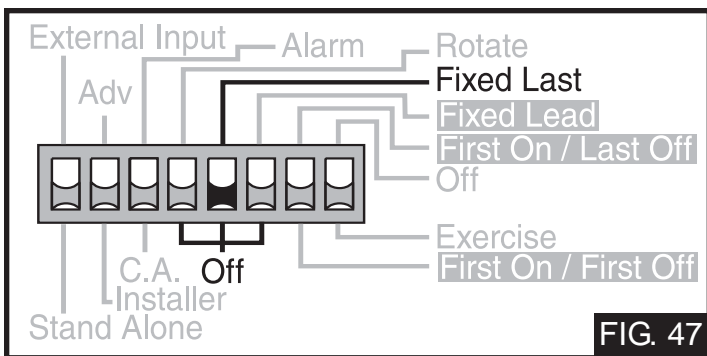

The Fixed Lead / Off DIP switch selects whether or not the first boiler is to be included in the rotation sequence. If the DIP switch is set to Fixed Lead, the first boiler is always the first to fire (FIG. 48). This DIP switch is only active when the Rotate / Off DIP switch is set to Rotate.

FIRST ON / LAST OFF OR FIRST ON / FIRST OFF

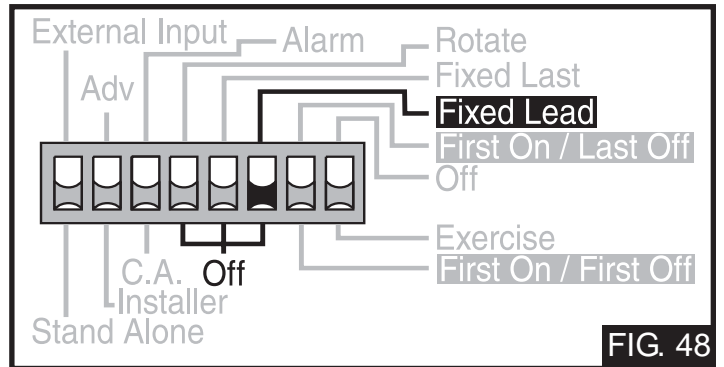

The First On / Last Off or First On / First Off DIP switch selects whether the first boiler is the first to stage on and the last to stage off or the first to stage on and the first to stage off. This DIP switch is only active when the Rotate / Off DIP switch is set to Rotate and the Fixed Lead / Off DIP switch is set to Fixed Lead (FIG. 49).

OFF / EXERCISE

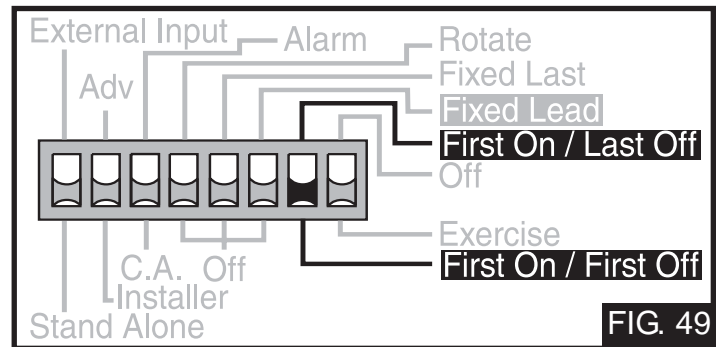

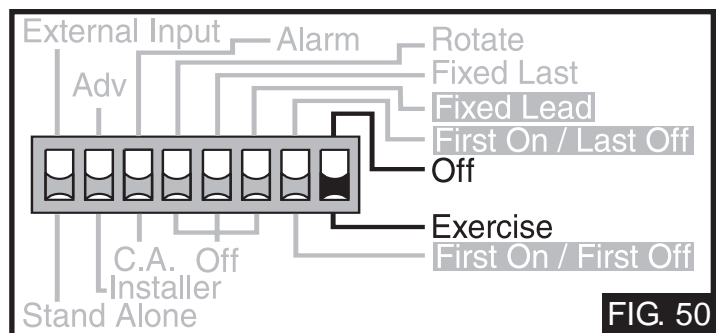

The Off / Exercise DIP switch selects whether or not the control is to exercise the primary pump and boiler pumps (FIG. 50). If the DIP switch is set to Exercise, the pumps are operated for 10 seconds after every three days of inactivity.







Display	Section		Description	Range
	Installer	Advanced		
	•	•	Outdoor - Current outdoor air temperature as measured by the outdoor sensor. This item is only available if the <i>External Input/Stand Alone</i> DIP switch is set to Stand Alone. This item is available in all modes.	-67 to 149°F (-55 to 65°C)
	•	•	Boiler Supply - Current boiler supply water temperature as measured by the boiler supply sensor. This item is available in all modes.	14 to 266°F (-10 to 130°C)
	DI	FE1	Boiler Target - Boiler target temperature is the temperature the control is currently trying to maintain at the boiler supply sensor +/- 1/2 of the differential. This item is available in all modes.	---, 14 to 266°F (---, -10 to 130°C)
			Boiler Return - Current boiler return water temperature as measured by the boiler return sensor. A boiler return sensor must be installed to view this item. This item is available in all modes.	14 to 266°F (-10 to 130°C)
			Delta T - Current difference in temperature between the boiler supply sensor and the boiler return sensor temperatures. A boiler return sensor must be installed to view this item. This item is available in all modes.	0 to 252°F (0 to 140°C)
	A		Boiler 1 Hours - The total running time of boiler 1 since this item was last cleared. To clear this item, press the ▲ and ▼ arrow button simultaneously while viewing this item. This item is available in all modes.	0 to 1999 hr
	A		Boiler 2 Hours - The total running time of boiler 2 since this item was last cleared. To clear this item, press the ▲ and ▼ arrow button simultaneously while viewing this item. This item is available in modes 1 to 3.	0 to 1999 hr
	A		Boiler 3 Hours - The total running time of boiler 3 since this item was last cleared. To clear this item, press the ▲ and ▼ arrow button simultaneously while viewing this item. This item is available in mode 1.	0 to 1999 hr
	A		Boiler 4 Hours - The total running time of boiler 4 since this item was last cleared. To clear this item, press the ▲ and ▼ arrow button simultaneously while viewing this item. This item is available in mode 1.	0 to 1999 hr
	A		Boiler 5 Hours - The total running time of boiler 5 since this item was last cleared. To clear this item, press the ▲ and ▼ arrow button simultaneously while viewing this item. This item is available in mode 1.	0 to 1999 hr
	A		Boiler 6 Hours - The total running time of boiler 6 since this item was last cleared. To clear this item, press the ▲ and ▼ arrow button simultaneously while viewing this item. This item is available in mode 1 only.	0 to 1999 hr

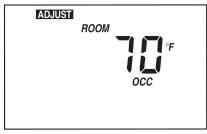
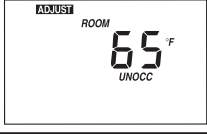

View Menu (2 of 2)

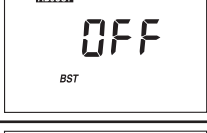
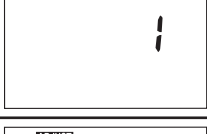
Display	Section		Description	Range
	Installer	Advanced		
	A	●	Boiler 7 Hours - The total running time of boiler 7 since this item was last cleared. To clear this item, press the ▲ and ▼ arrow button simultaneously while viewing this item. This item is available in mode 1 only.	0 to 1999 hr
	A	●	Boiler 8 Hours - The total running time of boiler 8 since this item was last cleared. To clear this item, press the ▲ and ▼ arrow button simultaneously while viewing this item. This item is available in mode 1 only.	0 to 1999 hr
	A	●	Boiler 9 Hours - The total running time of boiler 9 since this item was last cleared. To clear this item, press the ▲ and ▼ arrow button simultaneously while viewing this item. This item is available in mode 1 only.	0 to 1999 hr

Adjust Menu (1 of 4)

Display	Section		Description	Range	Actual Setting
	Installer	Advanced			
	D1	●	Room Occupied - The desired room air temperature during the occupied period. This item is only available if the <i>External Input / Stand Alone DIP switch</i> is set to Stand Alone.	35 to 100°F (2 to 38°C) Default = 70°F (21°C)	
	D1	●	Room Unoccupied - The desired room air temperature during the unoccupied period. This item is only available if the <i>External Input / Stand Alone DIP switch</i> is set to Stand Alone.	35 to 100°F (2 to 38°C) Default = 65°F (18°C)	
	F1	●	External Input Signal - Selects the range of the external input signal. This item is only available if the <i>External Input / Stand Alone DIP switch</i> is set to External Input.	0:10, 2:10 Default = 0:10	
	F1	●	Offset - Sets the temperature offset used in calculating the boiler target temperature with an external input signal. This item is only available if the <i>External Input / Stand Alone DIP switch</i> is set to External Input.	-10 to 10°F (-6 to 6°C) Default = 0°F (0°C)	
	D1	●	Boost - The amount of morning boost. This item is only available if the <i>External Input / Stand Alone DIP switch</i> is set to Stand Alone.	OFF, 0:20 to 8:00 hr (5 minute increment) Default = OFF	
	B1	●	Mode - Selects the staging mode of operation.	1 (9 Boil), 2 (4 Boil 4 Pmp), 3 (4 LoHi), 4 (3 LoHi 3 Pmp), 5 (3-3 Stg), 6 (2-3 Stg 2 Pmp), 7 (2-4 Stg), 8 (1-4 Stg 1 Pmp) Default = 1	
	B1	●	Boiler 1 - Selects whether or not boiler 1 is operational. This item is available in all modes.	Au (Auto), OFF Default = Au	

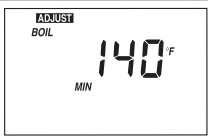
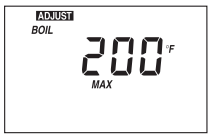
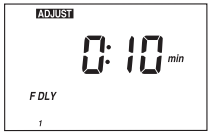
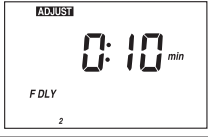
Display	Section		Description	Range	Actual Setting
	Installer	Advanced			
	B1	●	Boiler 2 - Selects whether or not boiler 2 is operational. This item is available in modes 1 to 7.	Au (Auto), OFF Default = Au	
	B1	●	Boiler 3 - Selects whether or not boiler 3 is operational. This item is available in modes 1 to 5.	Au (Auto), OFF Default = Au	
	B1	●	Boiler 4 - Selects whether or not boiler 4 is operational. This item is available in modes 1 to 3.	Au (Auto), OFF Default = Au	
	B1	●	Boiler 5 - Selects whether or not boiler 5 is operational. This item is available in mode 1.	Au (Auto), OFF Default = Au	
	B1	●	Boiler 6 - Selects whether or not boiler 6 is operational. This item is available in mode 1.	Au (Auto), OFF Default = Au	
	B1	●	Boiler 7 - Selects whether or not boiler 7 is operational. This item is available in mode 1.	Au (Auto), OFF Default = Au	
	B1	●	Boiler 8 - Selects whether or not boiler 8 is operational. This item is available in mode 1.	Au (Auto), OFF Default = Au	
	B1	●	Boiler 9 - Selects whether or not boiler 9 is operational. This item is available in mode 1.	Au (Auto), OFF Default = Au	
	D1	●	Outdoor Design - The design outdoor air temperature used in the heat loss calculations for the heating system. This item is only available if the <i>External Input / Stand Alone DIP switch</i> is set to Stand Alone.	-60 to 45°F (-51 to 7°C) Default = 10°F (-12°C)	
	D1	●	Terminal Unit - The type of terminal units that are being used in the heating system. This item is only available if the <i>External Input / Stand Alone DIP switch</i> is set to Stand Alone.	1 (HRF1), 2 (HRF2), 3 (COIL), 4 (CONV), 5 (RAD), 6 (BASE) Default = 4	
	D1	●	Boiler Indoor - The design indoor air temperature used in the heat loss calculation for the heating system. The item is only available if the <i>External / Input Stand Alone DIP switch</i> is set to Stand Alone.	35 to 100°F (2 to 38°C) Default = 70°F (21°C)	
	D1	●	Boiler Design - The design supply water temperature used in the heat loss calculations for the heating system. This item is only available if the <i>External Input / Stand Alone DIP switch</i> is set to Stand Alone.	70 to 220°F (21 to 104°C) Default = 180°F (82°C)	

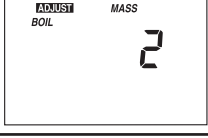
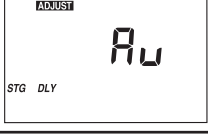
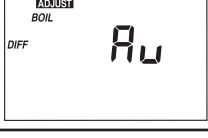
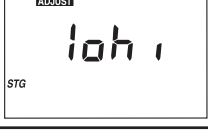
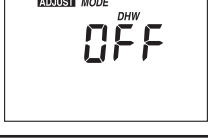
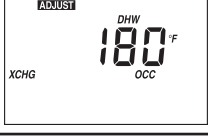
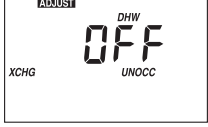
Display	Section		Description	Range	Actual Setting
	Installer	Advanced			
	A	●	Boiler Minimum -The minimum allowed boiler target temperature.	OFF, 80 to 180°F (OFF, 27 to 82°C) Default = 140°F (60° C)	
	A	●	Boiler Maximum -The maximum allowed boiler target temperature.	120 to 225°F, OFF (49 to 107°C, OFF) Default = 200°F (93°C)	
	B1	●	Fire Delay 1 - The time delay the control can expect between the time that the relay contact closes to fire the first stage of the boiler and the burner actually fires.	0:00 to 3:00 minutes (1 sec increment) Default = 0:10 min	
	B1	●	Fire Delay 2 -The time delay the control can expect between the time that the relay contact closes to fire the third stage of the boiler and the burner actually fires. This item is available in Modes 5 to 8.	0:00 to 3:00 minutes (1 sec increment) Default = 0:10 min	
	A	●	Combustion Air Damper Delay -The time allowed for the combustion air damper to open before the first stage is fired. This item is only available if the Alarm / C.A. DIP switch is set to C.A.	0:00 to 3:00 minutes (1 sec increment) Default = 1:00 min	
	B1	●	Boil Mass - The thermal mass characteristics of the boilers that are being used.	1 (Lo), 2 (Med), 3 (Hi) Default = 2	
	B1	●	Stage Delay - The minimum time delay between the operation of stages.	Au (Auto), 0:30 to 19:55 min (5 second increment) Default = Au	
	B1	●	Boiler Differential - The temperature differential that the control is to use when it is operating the boiler(s).	Au (Auto), 2 to 42°F (Au, 1 to 23°C) Default = Au	
	B1	●	Staging - Selects the firing sequence of the stages when using multi-stage boilers. This item is only available in Modes 3 to 7.	lohi, lolo Default = lohi	
	E1	●	DHW Mode - Selects the DHW mode of operation. This item is only available when the last boiler in MODES 1,4, and 5 is set to OFF.	OFF 1 (parallel, no priority), 2 (parallel, priority), 3 (pri-sec, no priority), 4 (pri-sec, priority) Default = OFF	
	E1	●	DHW Exchange Occupied - The minimum boiler supply temperature to the DHW heat exchanger during the Occupied period. (This item is only available when the last boiler in MODES 1, 4, and 5 is set to OFF and DHW MODE is set to 1 through 4.)	OFF, 100 to 220°F (OFF, 38 to 104°C) Default = 180°F (82°C)	
	E1	●	DHW Exchange Unoccupied - Selects whether or not a DHW demand will be responded to during the UnOccupied period. (This item is only available when the last boiler in MODES 1, 4, and 5 is set to OFF and DHW MODE is set to 1 through 4.)	OFF, On Default = OFF	

Display	Section		Description	Range	Actual Setting
	Installer	Advanced			
	E1	●	DHW Boilers - Selects how many boilers are to be operated during DHW generation. <i>(This item is only available when the last boiler in MODES 1, 4, and 5 is set to OFF and DHW MODE is set to 1 through 4.)</i>	1 to Max number of boilers Default = Maximum number of boilers	
	F1	●	Set Point Mode - Selects the Set Point Mode of operation. <i>(This item is only available when DHW MODE is set to OFF.)</i>	1 (parallel, no priority), 2 (parallel, priority), 3 (primary pump), Default = 1	
	F1	●	Set Point Occupied - The minimum supply temperature when a set point demand is present during the Occupied period. <i>(This item is only available when DHW MODE is set to OFF.)</i>	OFF, 60 to 220°F (OFF, 16 to 104°C) Default = 180°F (82°C)	
	F1	●	Set Point Unoccupied - Selects whether or not a set point demand will be responded to during the Unoccupied period. <i>(This item is only available when DHW MODE is set to OFF.)</i>	OFF, On Default = OFF	
	E1 F1	●	Priority Override - Sets the maximum amount of time the control provides DHW or Set Point priority before resuming space heating. <i>(This item is only available when Set Point MODE is set to 2, or when DHW MODE is set to 2 or 4 and the last boiler in MODES 1, 4, and 5 are set to OFF.)</i>	OFF, 0:20 to 4:00 hr (10 minute increments) Default = OFF	
	D1	●	WWSD Occupied - The system's warm weather shut down temperature during the Occupied period. <i>(This item is only available if the External Input / Stand Alone DIP switch is set to Stand Alone.)</i>	OFF, 35 to 100°F (OFF, 2 to 38°C) Default = 70°F (21°C)	
	D1	●	WWSD UnOccupied - The system's warm weather shut down temperature during the UnOccupied period. <i>(This item is only available if the External Input/ Stand Alone DIP switch is set to Stand Alone.)</i>	OFF, 35 to 100°F (OFF, 2 to 38°C) Default = 60°F (15.5°C)	
	C1	●	Primary Pump Purge - The maximum length of time that the primary pump will continue to operate after the boiler demand has been removed.	OFF, 0:10 to 19:55 min Default = 0:20 min	
	C1	●	Boiler Pump Purge - The length of time that the boiler pump will continue to run after the last stage in the boiler has turned off. <i>(This item is only available in modes 2, 4, 6, and 8).</i>	OFF, 0:10 to 19:55 min Default = 0:20 min	
	A	●	Boiler Alarm - The alarm signal will be activated if the boiler supply temperature does not increase within the selected time. <i>(This item is only available when the Alarm / C.A. DIP switch is set to Alarm.)</i>	OFF, 3 to 40 min (1 minute increments) Default = 20 min	
		●	Units - The units of measure that all of the temperatures are to be displayed in by the control.	°F, °C Default = °F	

TESTING THE CONTROL

The control has a built-in test routine that is used to test the main control functions. The control continually monitors the sensors and displays an error message whenever a fault is found. See the following pages for a list of the control's error messages and possible causes. When the **Test** button is pressed, the test light is turned on. The individual outputs and relays are tested in the following test sequence.

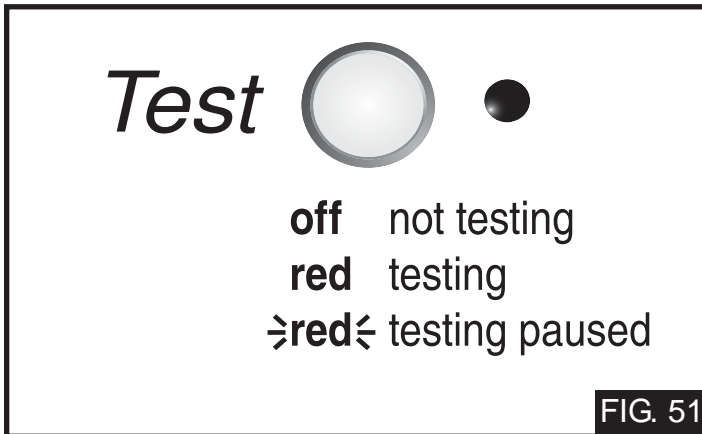

FIG. 51

TEST SEQUENCE

Each step in the test sequence lasts 10 seconds.

During the test routine, if a demand from the system is present, the test sequence may be paused by pressing the **Test** button. If the **Test** button is not pressed again for 5 minutes while the test sequence is paused, the control exits the entire test routine. If the test sequence is paused, the Test button can be pressed again to advance to the next step. This can also be used to rapidly advance through the test sequence. To reach the desired step, repeatedly press and release the Test button until the appropriate device and segment in the display turn on.

Step 1 The primary pump is turned on and remains on for the entire test routine.

Step 2 If the Alarm / C.A. DIP switch is set to Alarm, the Alarm contact is turned on for 10 seconds and then shuts off. If the Alarm / C.A. DIP switch is set to C.A., the combustion Air Damper contact is turned on and remains on for the entire test routine.

Step 3 For each boiler that is set to Auto, the following test sequence is used.

- If the mode indicates that a boiler pump is used, the boiler pump is turned on and remains on.
- Next, the first stage of the boiler is turned on and remains on.
- If a second stage is present, the second stage is turned on and remains on.
- If a third stage is present, the third stage is turned on and remains on. If a fourth stage is

present, the fourth stage is turned on.

- After ten seconds, all stages and the boiler pump are turned off.

Step 4 If DHW MODE is set to 1 or 2 and the last boiler in modes 1, 4, and 5 are set to OFF, the primary pump is shut off and the DHW contact is closed.

Step 5 If DHW MODE is set to 3 or 4 and the last boiler in modes 1, 4, and 5 are set to OFF, the primary pump stays on and the DHW contact is closed.

Step 6 All contacts are turned off.

MAX HEAT

The control has a function called Max Heat, see Figure 52. In this mode, the control turns on and operates the system up to the maximum set temperatures as long as there is a demand for heat. The control continues to operate in this mode for up to 24 hours or until the Item, Menu or Test button is pressed. This mode may be used for running all circulators during system start-up in order to purge air from the piping. To enable the Max Heat feature, use the following procedure.

- 1) Press and hold the Test button for more than 3 seconds. At this point, the control flashes the MAX segment and displays the word OFF.
- 2) Using the up or down arrow buttons, select the word On. After 3 seconds, the control turns on all outputs. However, the max heat mode is still limited by the BOIL MAX setting.
- 3) To cancel the Max Heat mode, press the Item, Menu, or Test button.
- 4) Once the Max Heat mode has either ended or is cancelled, the control resumes normal operation.

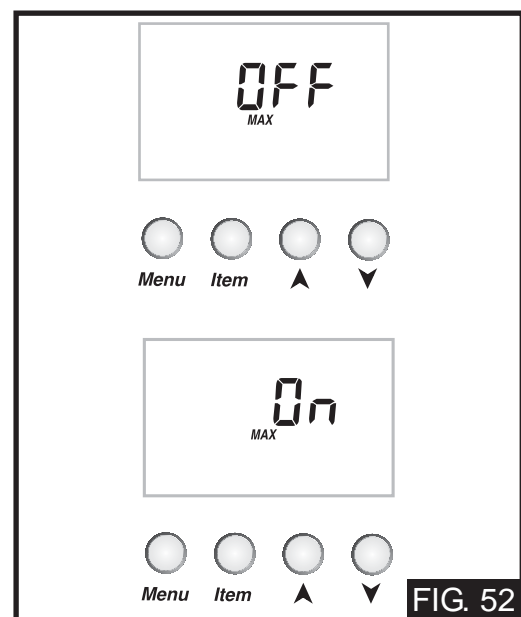

FIG. 52

ERROR MESSAGES



The control was unable to read a piece of information stored in its memory (FIG. 53). Because of this, the control was required to reload the factory settings into all of the items in the ADJUST menu. The control will stop operation until all of the items in the ADJUST menu of the control have been checked by the user or installer.

Note: The Installer / Adv DIP Switch must be set to Adv in order to clear the error.

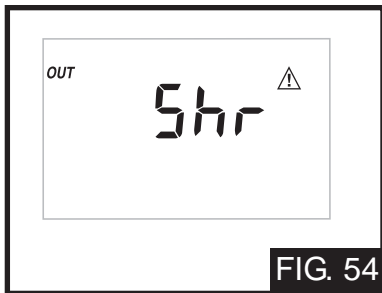

The control is no longer able to read the outdoor sensor due to a short circuit (FIG. 54). In this case the control assumes an outdoor temperature of 32°F (0°C) and continues operation. Locate and repair the problem as described in INS7141. To clear the error message from the control after the sensor has been repaired, press either the Menu or Item button. This error message only occurs if the External Input / Stand Alone DIP switch is set to Stand Alone.

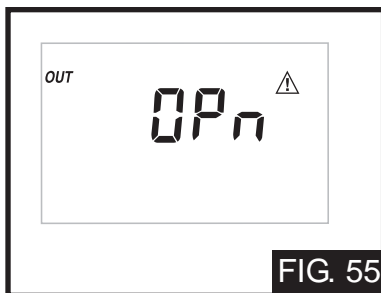

The control is no longer able to read the outdoor sensor due to an open circuit (FIG. 55). In this case the control assumes an outdoor temperature of 32°F (0°C) and continues operation. Locate and repair the problem as described in INS7141. To clear the error message from the control after the sensor has been repaired, press either the Menu or Item button. This error message only occurs if the External Input / Stand Alone DIP switch is set to Stand Alone.

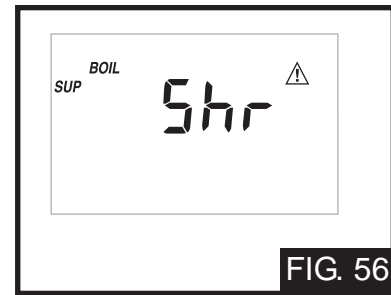

The control is no longer able to read the boiler supply sensor due to a short circuit (FIG. 56). The control will not operate the boiler(s) until the sensor is repaired. Locate and repair the problem as described in INS7141. To clear the error message from the control after the sensor has been repaired, press either the Menu or Item button.

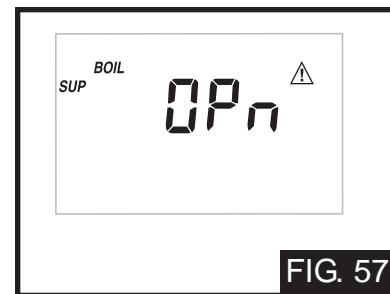

The control is no longer able to read the boiler supply sensor due to an open circuit (FIG. 57). The control will not operate the boiler(s) until the sensor is repaired. Locate and repair the problem as described in INS7141. To clear the error message from the control after the sensor has been repaired, press either the Menu or Item button.

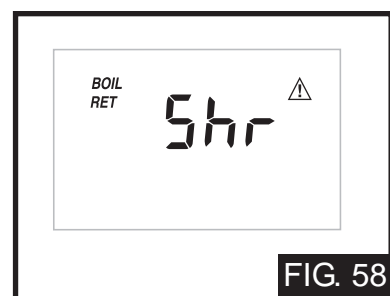

The control is no longer able to read the boiler return sensor due to a short circuit (FIG. 58). The control will continue to operate normally. Locate and repair the problem as described in INS7141. To clear the error message from the control after the sensor has been repaired, press either the Menu or Item button.

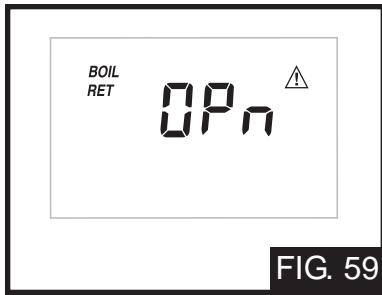

- Power Supply - 115 V (ac) ± 10% 50/60 Hz
600 Va
- Relay Capacity - 230 V (ac) 5 A 1/3 hp pilot duty
230 VA
- Demands - 20 to 260 V (ac) 2 VA
- Sensors Included - NTC thermistor, 10 kΩ @ 77°F
(25°C ± 0.2°C) B=3892

The control is no longer able to read the boiler return sensor due to an open circuit (FIG. 59). The control will continue to operate normally. Locate and repair the problem as described in INS7141. To clear the error message from the control after the sensor has been repaired, press either the Menu or Item button.

If the boiler return sensor was deliberately removed from the control, remove power from the control and repower the control to clear the error message.

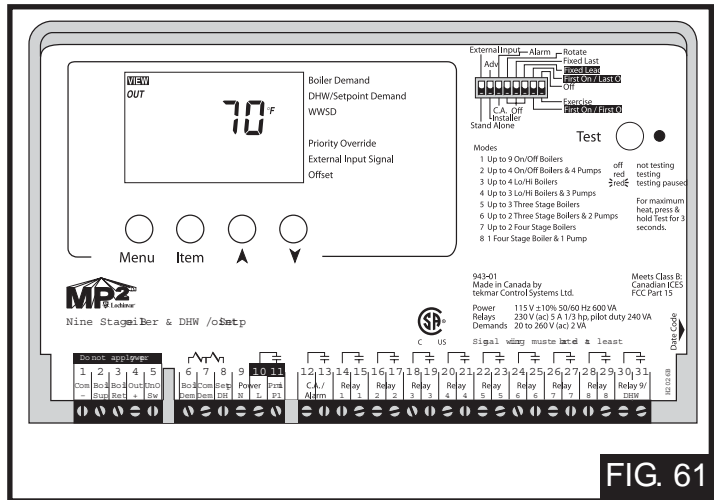
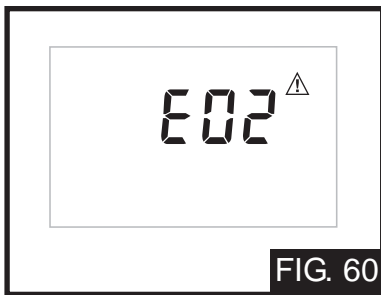

The control has detected no increase in the supply water temperature within the BOIL Alarm time setting. Check to see if the boilers are operating properly using the Test button. To reset the alarm, press and hold the up and down arrow buttons for 5 seconds while in the VIEW menu.

The installer must ensure that this control and its wiring are isolated and/or shielded from strong sources of electromagnetic noise. Conversely, this Class B digital apparatus complies with Part 15 of the FCC Rules and meets all requirements of the Canadian Interference - Causing Equipment Regulations. However, if this control does cause harmful interference to radio or television reception, which is determined by turning the control off and on, the user is encouraged to try to correct the interference by re-orientating or relocating the receiving antenna, relocating the receiver with respect to this control, and/or connecting the control to a different circuit from that to which the receiver is connected.

TECHNICAL DATA

MP² NINE STAGE BOILER & DHW / SET POINT

- Control - Microprocessor PID control; This is **not a safety (limit) control**.
- Packaged Weight - 3.3 lb. (1500 g), Enclosure A, blue modified PPO plastic
- Dimensions - 6-5/8" H x 7-9/16" W x 2-13/16" D
(170 x 193 x 72 mm)
- Approvals - CSA C US, meets ICES & FCC regulations for EMI/RFI
- Ambient Conditions - Indoor use only, 30 to 120°F (0 to 50°C), <95% RH non-condensing

⚠ CAUTION

The nonmetallic enclosure does not provide grounding between conduit connections. Use grounding type bushings and jumper wires.

TYPICAL BOILER INSTALLATION

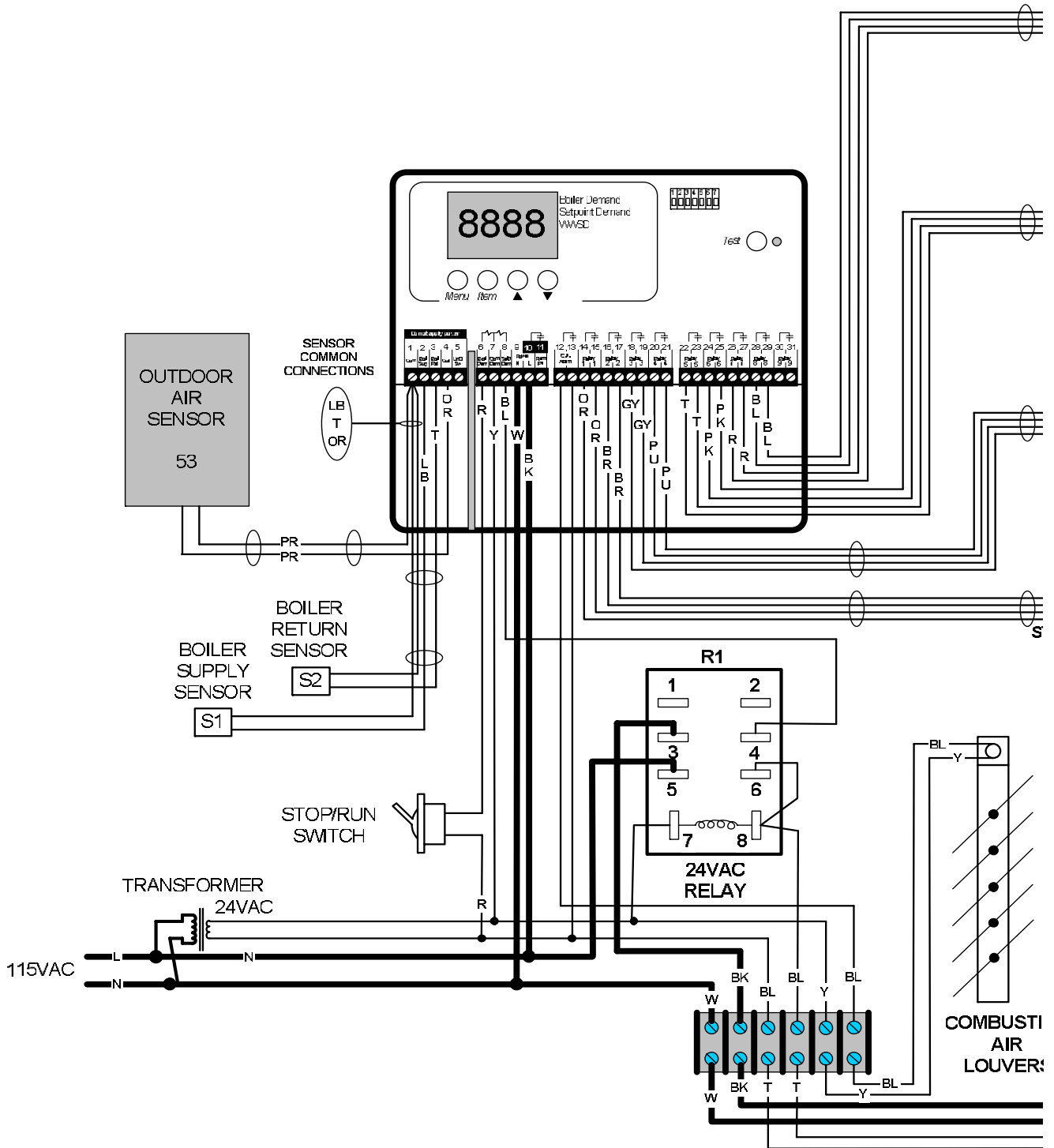

TYPICAL BOILER INSTALLATION (CONTINUED)

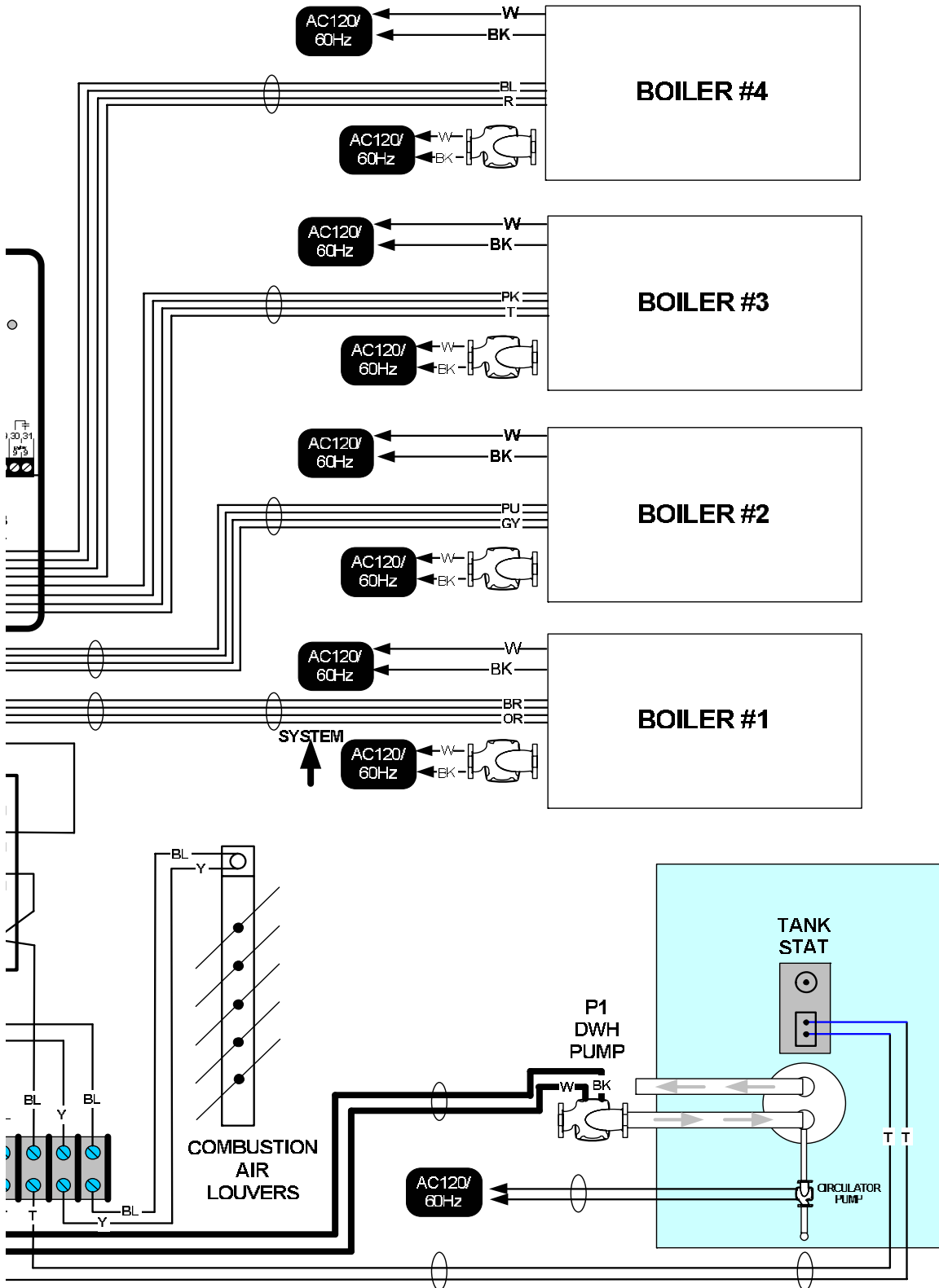

TYPICAL DWH PRIORITY HEATING PACKAGE SYSTEM

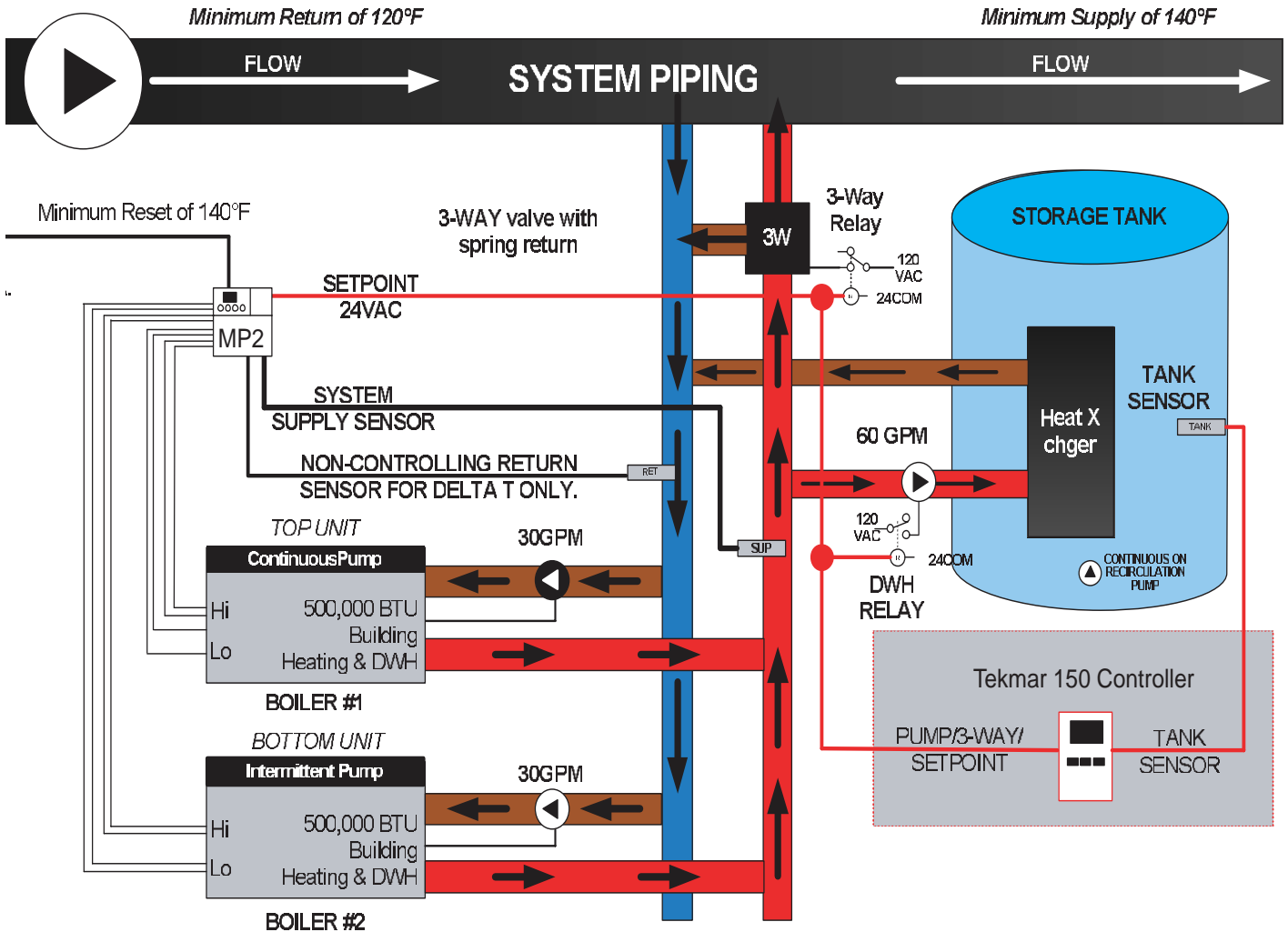

04-11-03

Free Manuals Download Website

<http://myh66.com>

<http://usermanuals.us>

<http://www.somanuals.com>

<http://www.4manuals.cc>

<http://www.manual-lib.com>

<http://www.404manual.com>

<http://www.luxmanual.com>

<http://aubethermostatmanual.com>

Golf course search by state

<http://golfingnear.com>

Email search by domain

<http://emailbydomain.com>

Auto manuals search

<http://auto.somanuals.com>

TV manuals search

<http://tv.somanuals.com>