



Logitech® Tablet Keyboard

for Windows® 8, Windows® RT and Android™ 3.0+

Setup Guide
Guide d'installation



English.	3
Français	6
www.logitech.com/support 	9

What's in the box

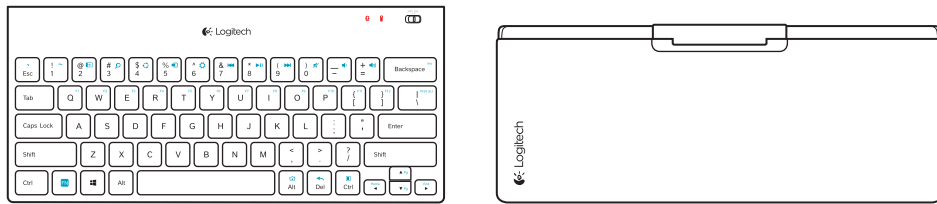

Product setup

Set up the keyboard

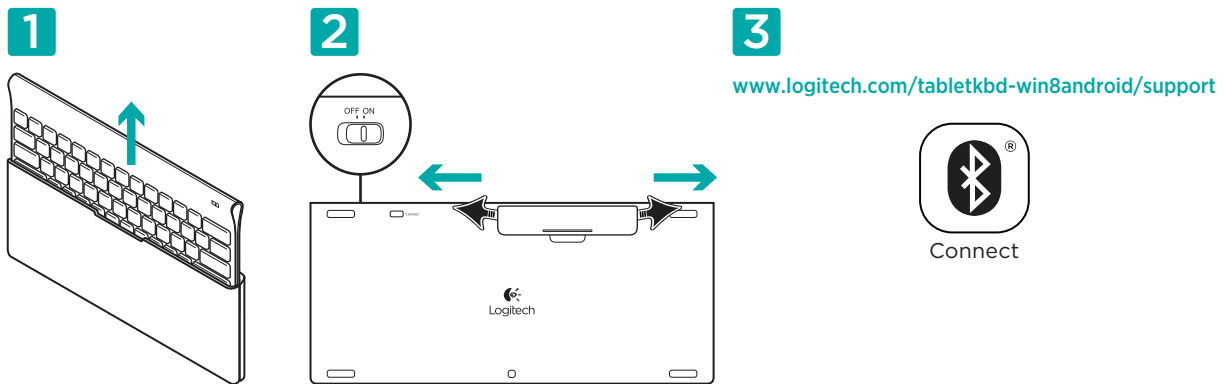

1. Remove the keyboard from its case.
2. Pull the battery tabs on the keyboard to activate the batteries. The **On/Off** switch is already in the **On** position.
3. Visit www.logitech.com/tabletkbd-win8android/support for Bluetooth setup instructions for your tablet.



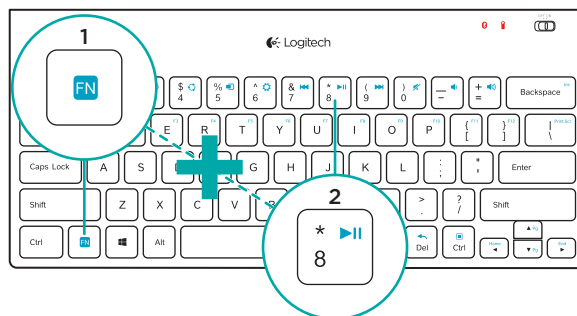



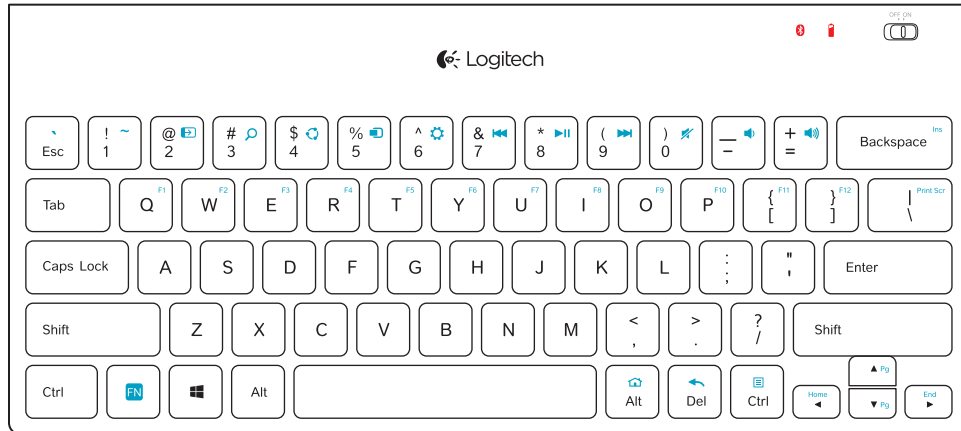

Using the keyboard FN key













User-friendly enhanced F-keys provide shortcuts to useful functions, such as Volume, Play and Next Track. To use the enhanced functions (blue icons), first press and hold the FN key; second, press the F-key you want to use.



Function Keys

-  Switch Applications
-  Search
-  Share
-  Devices
-  Settings
-  Previous track
-  Play/Pause
-  Next track
-  Mute

-  Volume down
-  Volume up
-  Insert
-  Print Screen
-  Windows 8:
Web browser home
Android: Home
-  Windows 8:
Web browser back
Android: Back

-  Application Menu
-  Home (go to beginning of line)
-  End (go to end of line)
-  Page up
-  Page down

Note: Some function keys may not provide the same features for earlier versions of Windows®.

Keyboard features

-  Bluetooth icon
Blinking green = device is discoverable and Bluetooth connection is pending; Solid green = Bluetooth connection made; Red = no Bluetooth connection

-  Battery icon
Green = full charge;
Red = battery power is low; replace batteries

-  On/Off slider switch

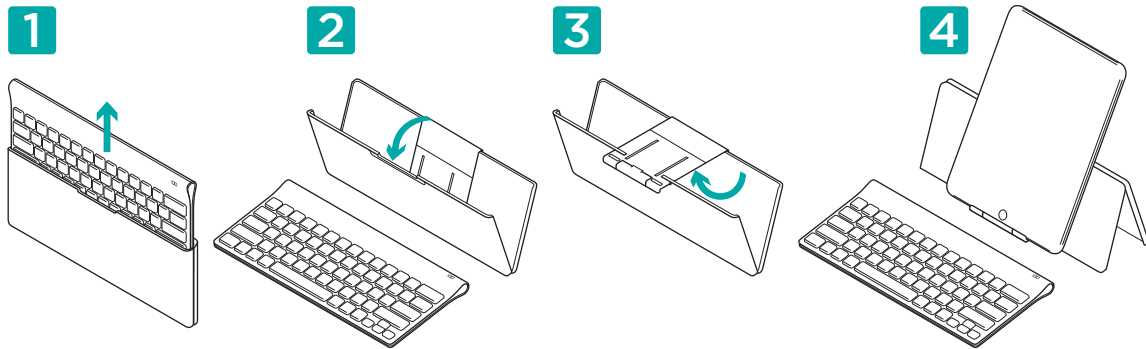

Help with setup: keyboard not working

- Is the keyboard turned on? Slide the keyboard Off/On switch to the On position.
- Restart the tablet.
- Is the Battery icon red? If it's red, replace the batteries.
- Re-establish the Bluetooth connection between the keyboard and your tablet. Visit www.logitech.com/tabletkbd-win8android/support for Bluetooth setup instructions.

What do you think?

Please take a minute to tell us. Thank you for purchasing our product.

www.logitech.com/ithink

Contenu du coffret

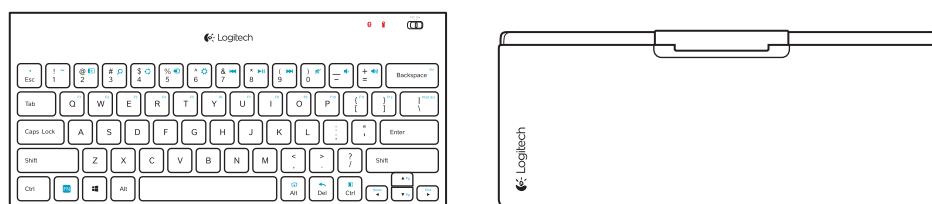

Installation du produit

Installez le clavier

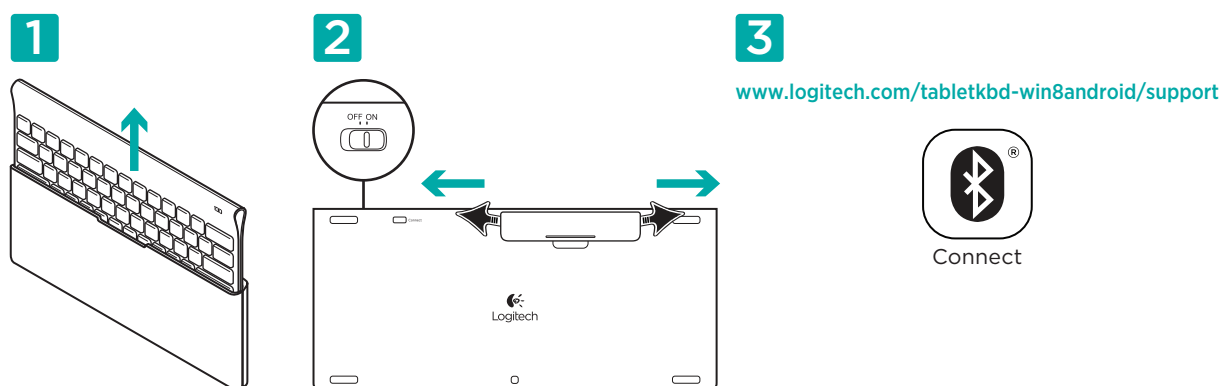

1. Retirez le clavier de son étui.
2. Retirez les languettes de protection des piles situées sur la face arrière du clavier pour activer les piles. Le commutateur **Marche/Arrêt** (On/Off) est déjà sur la position **Marche** (On).
3. Visitez le site www.logitech.com/tabletkbd-win8android/support pour obtenir les instructions de configuration du Bluetooth pour votre tablette.

Utilisation de la touche FN du clavier

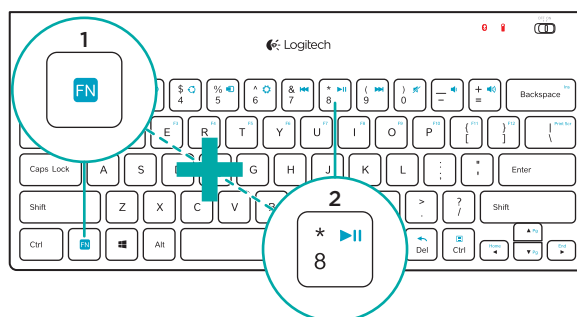

Les touches F conviviales offrent des raccourcis pour des fonctions telles que Volume, Lecture et Piste suivante. Pour profiter des fonctions avancées (icônes de couleur bleue), appuyez sur la touche FN sans la relâcher et sur la touche F de votre choix.

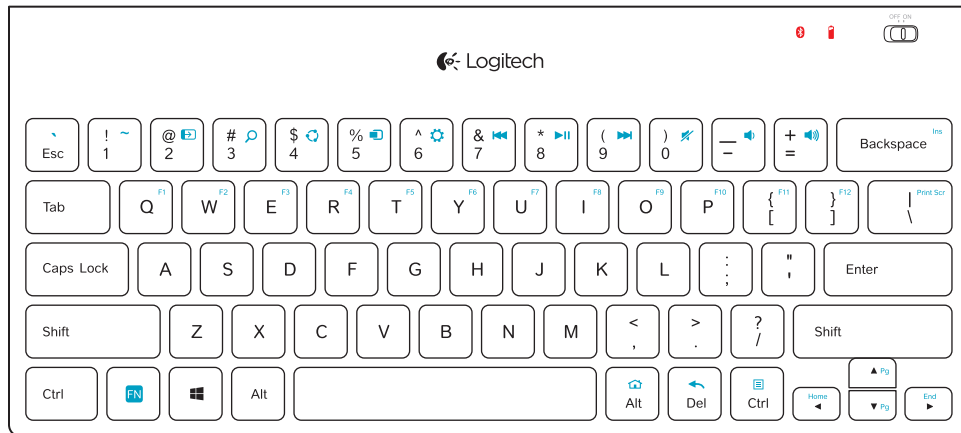

Touches de fonction

Changement d'application

Recherche

Partage

Dispositifs

Paramètres

Piste précédente

Lecture/Pause

Piste suivante

Sourdine

Volume -

Volume +

Insertion

Impression d'écran

Windows 8:
Page d'accueil
du navigateur web
Android: Accueil

Windows 8:
Page précédente
du navigateur web
Android: Retour

Menu de l'application

Origine
(début de ligne)

Fin (fin de ligne)

Page précédente

Page suivante

Remarque: certaines touches de fonction peuvent offrir des fonctions différentes sur les versions antérieures de Windows®.

Fonctions du clavier

Icône Bluetooth
Vert clignotant = le dispositif peut être détecté et la connexion Bluetooth est en attente;
Vert fixe = la connexion Bluetooth est établie;
Rouge = aucune connexion Bluetooth

Icône de niveau des piles
Vert = charge complète;
Rouge = le niveau de charge des piles est faible; remplacez-les

Commutateur
Marche/Arrêt

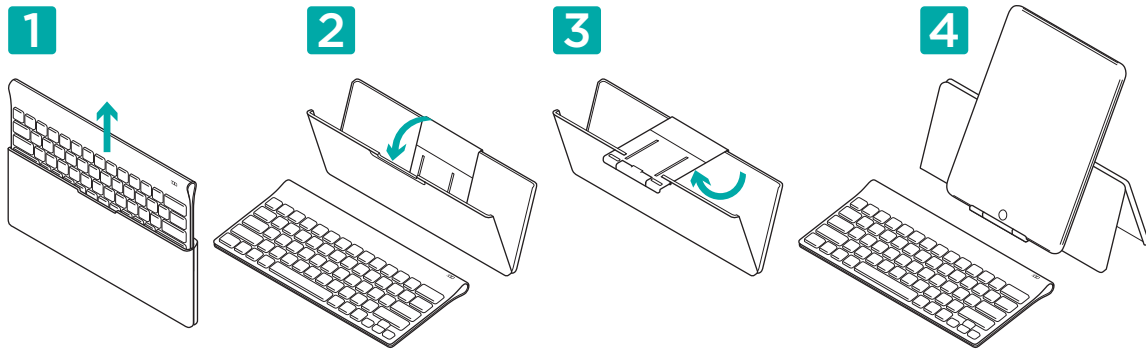

Aide à la configuration: le clavier ne fonctionne pas

- Le clavier est-il sous tension? Faites glisser le commutateur Marche/Arrêt du clavier sur la position On.
- Redémarrez la tablette.
- L'icône de niveau des piles s'allume-t-elle en rouge? Si oui, remplacez les piles.
- Rétablissez la connexion Bluetooth entre le clavier et la tablette. Visitez le site www.logitech.com/tabletkbd-win8android/support pour obtenir les instructions de configuration du Bluetooth.

Qu'en pensez-vous?

Veuillez prendre quelques minutes pour nous faire part de vos commentaires.
Nous vous remercions d'avoir acheté notre produit.

www.logitech.com/ithink



www.logitech.com

www.logitech.com/support



Argentina	+00800-555-3284
Brasil	+0 800-891-4173
Canada	+1 866-934-5644
Chile	1230 020 5484
Colombia	01-800-913-6668
Latin America	+1 800-578-9619
Mexico	01.800.800.4500
United States	+1 646-454-3200

© 2012 Logitech, Inc. All rights reserved. Logitech, the Logitech logo, and other Logitech marks are owned by Logitech and may be registered. Microsoft, Windows Vista, Windows, and the Windows logo are trademarks of the Microsoft group of companies. Android is a trademark of Google Inc. The Bluetooth® word mark and logos are owned by the Bluetooth SIG, Inc. and any use of such marks by Logitech is under license. All other trademarks are the property of their respective owners.

© 2012 Logitech. Tous droits réservés. Logitech, le logo Logitech et les autres marques Logitech sont la propriété exclusive de Logitech et sont susceptibles d'être des marques déposées. Microsoft, Windows Vista, Windows, et le logo Windows sont des marques déposées du groupe et des sociétés Microsoft. Android est une marque déposée de Google Inc. Le mot Bluetooth® et son logo sont des marques déposées de Bluetooth SIG, Inc. Toutes les autres marques sont la propriété exclusive de leurs détenteurs respectifs.

621-000089.002

Free Manuals Download Website

<http://myh66.com>

<http://usermanuals.us>

<http://www.somanuals.com>

<http://www.4manuals.cc>

<http://www.manual-lib.com>

<http://www.404manual.com>

<http://www.luxmanual.com>

<http://aubethermostatmanual.com>

Golf course search by state

<http://golfingnear.com>

Email search by domain

<http://emailbydomain.com>

Auto manuals search

<http://auto.somanuals.com>

TV manuals search

<http://tv.somanuals.com>