

DSC250 SCALE for LF1050 and LF1090 Lifts



USER MANUAL

**Read these instructions before using the Lumex Lift Scale.
Save these instructions for future reference.**

**The most current version of these instructions can be
found online at www.grahamfield.com.**



CONTENTS



INTRODUCTION	3
SAFETY	3
ASSEMBLY INSTRUCTIONS	5
COMPONENTS.....	5
INSTALLATION ON LUMEX LF1050 PATIENT LIFT	7
INSTALLATION ON LUMEX LF1090 PATIENT LIFT	8
OPERATION INSTRUCTIONS.....	9
KEYBOARD ILLUSTRATION.....	9
DISPLAY ILLUSTRATION	9
INSTRUCTIONS FOR USE	9
MAINTENANCE	11
CLEANING	11
BATTERY REPLACEMENT	11
SPECIFICATIONS.....	12
LIMITED WARRANTY.....	13

GF Health Products, Inc. is not responsible for typographical errors. For the most updated and current information on packaging, warranties, products and specifications, including the most current version of these instructions, please visit our website at www.grahamfield.com. **Graham-Field** and **Lumex** are registered trademarks of GF Health Products, Inc.

INTRODUCTION

Safety

-  **WARNING: Important! Read and understand these instructions before assembling or using the Lumex Lift Scale. If you do not understand any part of these warnings or instructions, contact a healthcare professional for direction in the use of this product. If the Lift Scale is not properly assembled, personal injury and damage to the Lift Scale could result.**
-  **WARNING: DO NOT use this product without proper instruction from a healthcare professional.**
-  **WARNING: If components are damaged or missing, contact your GF distributor immediately. DO NOT use substitute parts. Use only Lumex replacement parts. Non-Lumex replacement parts could cause personal injury and damage to the Lift Scale.**

-  **WARNING:** This product has a maximum weight capacity of 600 lb (300 kg). If patient weight exceeds maximum weight capacity, the scale will designate overload by displaying “-oL-”. DO not exceed the maximum weight capacity of the lift being used for measurement.
-  **WARNING:** California Proposition 65 **WARNING:** This product contains a chemical known to the State of California to cause cancer and reproductive or developmental harm.
-  **WARNING:** GF Health Products, Inc. assumes no responsibility for any damage or injury caused by improper assembly, installation or use of this product.







Intended Use

The intended use of the Lift Scale is the measurement of patient weight.

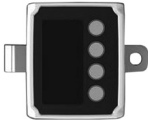
ASSEMBLY INSTRUCTIONS

Components

Ensure all components shown below are included in the package.

Item	Qty	Picture	Description
1	1		Scale
2	2		Bushing 1220
3	2		Bushing 1020
4	1		Universal bracket
5	2		Pin
6	2		Key ring

1. Follow these instructions to attach the scale to the LF1050 or LF1090 Lift using the included mounting hardware. Do not use any other mounting hardware than that provided.
2. Keep the scale in a cool, dry place. If operation temperature is over 104°F (40°C), the tolerance will not be accurate within 0.2 lb (0.1 kg). The storage temperature is 32°F ~158°F C (0°C ~ 70°).
3. When the low battery indicator () appears in the lower right corner of the display, replace the battery (see **MAINTENANCE** section).
4. If the scale is not used for an extended period of time, remove the battery.
5. This scale maximum weight capacity is 600 lb (300 kg). If patient weight exceeds maximum weight capacity, the scale will designate overload by displaying “-oL-”.

Installation on Lumex LF1050 Patient Lift

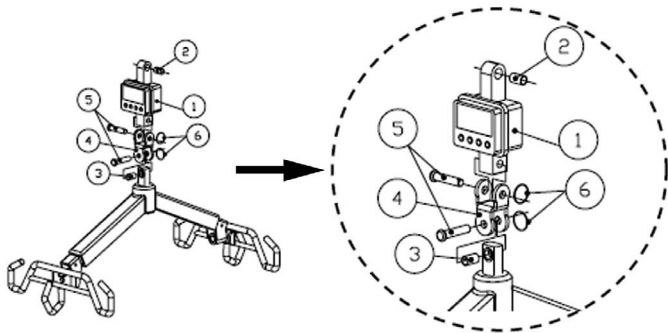

Install on Lumex LF1050 Patient Lift as shown above. Item numbers shown are those listed in the table shown on page 5.

⚠ WARNING: Ensure scale is securely mounted as shown above before proceeding.

Installation on Lumex LF1090 Patient Lift

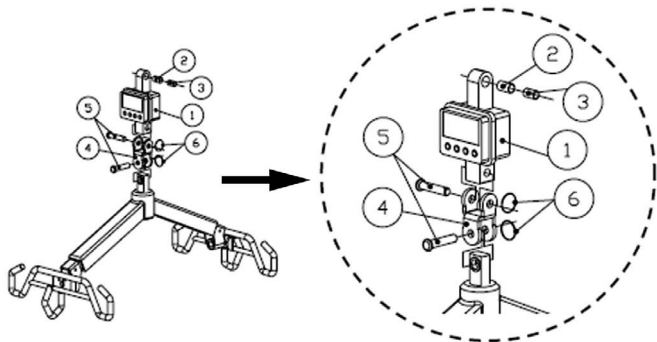

Install on Lumex LF1090 Patient Lift as shown above. Item numbers shown are those listed in the table shown on page 5.

⚠ WARNING: Ensure scale is securely mounted as shown above before proceeding.

OPERATION INSTRUCTIONS

Keyboard Illustration



Display Illustration

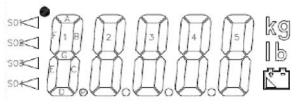

Instructions for Use

1. Place sling to be used onto spreader bar without patient/resident/user.
2. Press the **On/Zero** button on the scale faceplate to zero-out the weight of the sling (this weight will remain zeroed out until the **Off** button is pressed).
3. Press the **Kg/lb** button to select mode you prefer.

4. Carefully lift the patient/resident/user in the sling and perform the lift so that all of the weight is supported by the lift. Stabilize the movement of the sling after lifting.
5. Weight will display on the scale. Press the **Operate/Hold** button to hold the weight displayed. To reset the scale to zero, press the **Operate/Hold** button again.
6. Lower patient/resident/user safely.
7. If you are weighing another individual using the same sling, perform the lift and their weight will display. Press **Operate/Hold** to maintain their weight on the scale display.
8. Press the **Off** button when weighing procedure is complete.
9. The scale will automatically power off five minutes after measurement has been completed.

MAINTENANCE

Cleaning

As needed, wipe scale gently, using mild soap or a mild disinfectant.

▲ NOTICE: DO NOT wash under water pressure or steam clean. DO NOT use solvents, abrasive cleaners, or scouring pads to clean scale.

Battery Replacement

When the low battery indicator () appears in the display's right corner, replace the battery:

1. Open the scale back battery compartment.
2. Remove battery and replace with a 9V alkaline battery. Ensure that battery polarity is correct.
3. Close the scale back battery compartment.

If the scale is not used for an extended period of time, remove the battery.

SPECIFICATIONS

Model Number	DSC250	
Capacity	600 lb (300 kg)	
Resolution	1/3,000 \pm 1d	
Division	0.2 lb (0.1 kg)	
Power Source	9V alkaline battery x 1	
Temperature	Operating	32°F ~ 104°F (0°C ~ 40°C)
	Storage	32°F ~ 158°F (0°C ~ 70°C)
Dimensions (W x H x D)	3.54 x 2.83 x 2.17 in. (90 x 72 x 55 mm)	
Product Weight	24 oz \pm .35 oz / 1.5 lb \pm .02 lb (675 g \pm 10 g)	
LCD Display	2.60 x 1.28 in. (66.0 x 32.4 mm)	
Display Description	Five digit indication	
	Kg/lb selectable unit mode	
	Low power alarm battery symbol	
	S1 "Zero" indication	
	S4 "Hold" indication	
	(S2 and S3 are not used)	

LIMITED WARRANTY

GF Health Products, Inc. (“Graham-Field”) guarantees the Lumex DSC250 Lift Scale free from defects in materials and workmanship under normal use for two years from the date of purchase.

If a product is deemed to be under warranty, GF Health Products, Inc. shall provide, at its option, (1) replacement of any defective part or product or (2) a credit of the original selling price made to GF Health Products, Inc.’s initial customer. The warranty does not include any labor charges incurred in replacement part(s) installation or any associated freight or shipping charges to GF Health Products, Inc.

The warranties contained herein contain all the representations and warranties with respect to the subject matter of this document, and supersede all prior negotiations, agreements and understandings with respect thereto. The recipient of this document hereby acknowledges and represents that it has not

relied on any representation, assertion, guarantee, warranty, collateral contract or other assurance, except those set out in this document.

NOTES

GF Health Products, Inc.
2935 Northeast Parkway
Atlanta, GA 30360
telephone: 770-368-4700
fax: 770-368-2386



GRAHAM-FIELD[®]

www.grahamfield.com

© 2013 GF Health Products, Inc.
Made in Taiwan

Free Manuals Download Website

<http://myh66.com>

<http://usermanuals.us>

<http://www.somanuals.com>

<http://www.4manuals.cc>

<http://www.manual-lib.com>

<http://www.404manual.com>

<http://www.luxmanual.com>

<http://aubethermostatmanual.com>

Golf course search by state

<http://golfingnear.com>

Email search by domain

<http://emailbydomain.com>

Auto manuals search

<http://auto.somanuals.com>

TV manuals search

<http://tv.somanuals.com>