

LUMISCOPE®

A U T O M A T I C U P P E R A R M

Blood Pressure Monitor

Model 1131

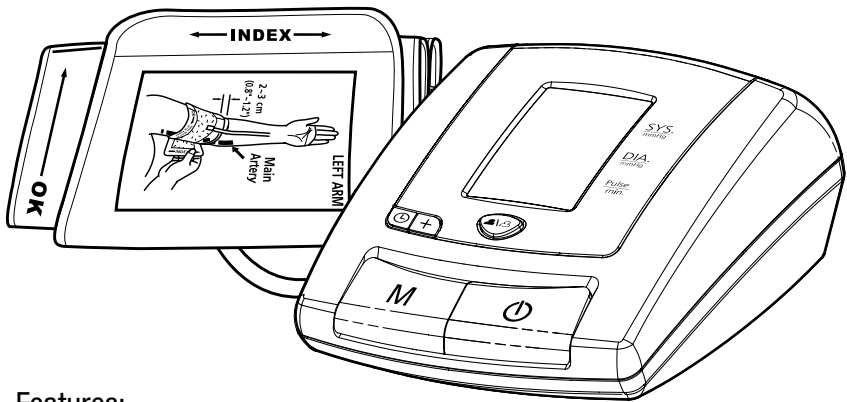

Features:

- Dual Person Memory Zones
- 50 Memories for each zone
- Average for Last 3 Memories
- Date and Time Stamp
- One Touch Operation

Table of Contents:

| | | | |
|---|----------|---|------------|
| Introduction | 2 | Measurement Procedures | 8,9 |
| Name/Function of Each Parts | 2 | Recalling Values from Memory | 10 |
| Quick Read Measuring Technology .. | 3 | Clearing Values from Memory | 11 |
| Preliminary Remarks | 3 | Time Adjustment | 12 |
| About Blood Pressure | 3 | Helpful Tips | 13 |
| Blood Pressure Standard | 4 | Troubleshooting | 14 |
| Blood Pressure Fluctuation | 4 | Cautionary Notes | 15 |
| Display Explanation | 5 | Specifications | 16 |
| Installing Battery | 6 | | |
| Applying the Cuff | 7 | | |

Introduction

Blood pressure measurements determined with Lumiscope Model 1131 are equivalent to those obtained by a trained observer using cuff/stethoscope auscultation method, within the limits prescribed by the American National Standard, Electronic or Automated Sphygmomanometers. This monitor is to be used by adult consumers in a home environment.

Lumiscope Model 1131 is protected against manufacturing defects by an established International Warranty Program. For warranty information see page 16 or contact the Lumiscope Repair Department at 1-800-672-8293.



Attention: Consult the accompanying documents before use.

- Please read this manual carefully before use, for specific information on your own blood pressure, contact your physician. Please be sure to keep this manual.

Name/Function of Each Part:

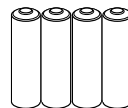
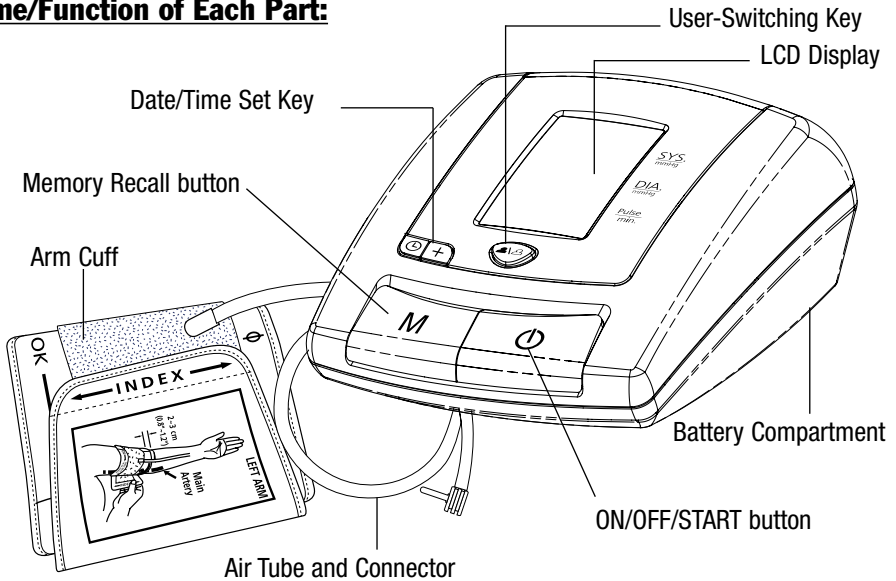

4 x 'AA' size, 1.5V
Batteries

Quick Read Measuring Technology

This monitor uses trend-setting Quick Read Technology to detect your blood pressure. With one touch of a button, the device will automatically start to inflate and determine your blood pressure by analysis of your pressure oscillations. When the measurement is completed, the device will exhaust cuff pressure and display your systolic, diastolic, and pulse. Measurement time is significantly shortened, and user comfort is greatly enhanced.

About Blood Pressure

What is Blood Pressure?

Blood pressure is the pressure exerted on the artery tube while blood flows through the arteries. The pressure measured when the heart contracts and sends blood out of the heart is systolic (highest). The pressure measured when the heart dilates with blood flowing back into the heart is called diastolic (lowest) blood pressure.

Why Measure Your Blood Pressure?

Among the various health problems today, problems associated with high blood pressure are by far the most common. High blood pressure's dangerously strong correlation with cardiovascular diseases has made measuring blood pressure a necessity for identifying those at risk.

Blood Pressure Standard

The World Health Organization (WHO) has developed a blood pressure standard, according to which areas of low- and high-risk blood pressure are identified. This standard, however, is a general guideline and blood pressures vary between different people, age groups, etc.

It is important that you consult with your physician regularly. Your physician will tell you your normal blood pressure range as well as the point at which you will be considered at risk.

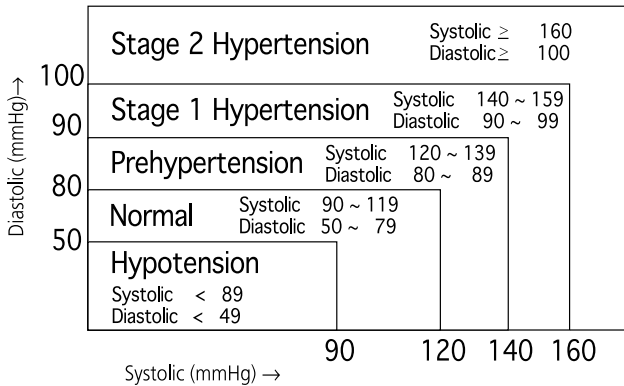

Blood Pressure Fluctuation

Blood pressure fluctuates all the time!

You should not be overly worried if you encountered two or three measurements at high levels. Blood pressure changes over the month and even throughout the day. It is also influenced by season and temperature.

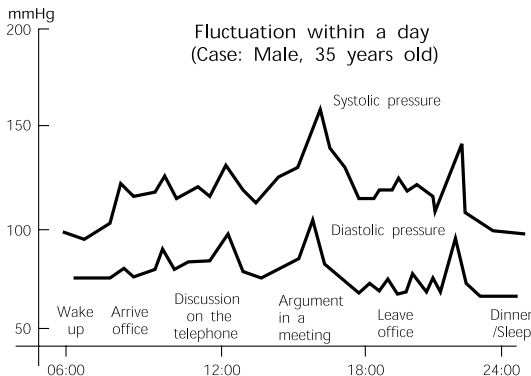

Display Explanation

Display:

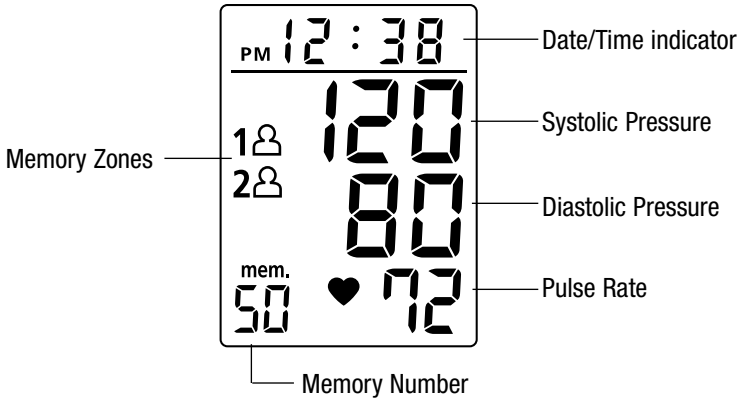

Icons:



Memory Zone 1: Appears when the monitor is operated in memory zone 1



Memory Zone 2: Appears when the monitor is operated in memory zone 2



Weak Battery Mark: Appears when batteries should be replaced



Pulse Mark: Shows the pulse rate per minute



Memory Mark: Shows the number of stored measurements



Error Mark: Occurs when a mistake was made during measurement

Installing Battery

1. Press down and lift the battery cover in the direction of the arrow to open the battery compartment.
2. Install or replace 4 “AA” sized batteries in the battery compartment according to the indications inside the compartment.
3. Replace the battery cover by clicking in the bottom hooks first, then push in the top end of the battery door.

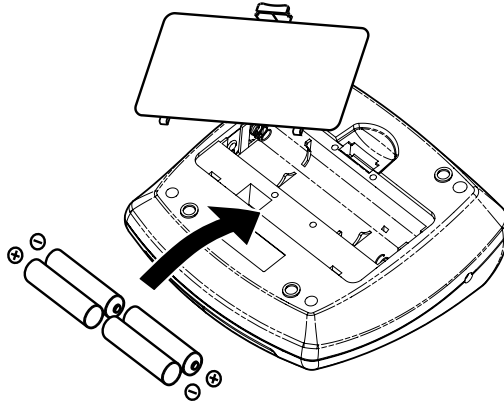

You need to replace the batteries when:

1. low battery icon appears on display.
2. the ON/OFF/START button is pushed and nothing appears on display.

Caution:  Batteries are hazardous waste.
Do not dispose together with the household garbage.

Using the AC adapter

1. Connect the AC adapter with the AC adapter jack in the back of the unit.
2. Plug the AC adapter into a standard wall socket.

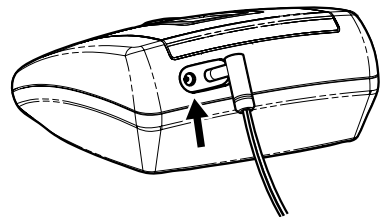

Caution:  1. Please unload the batteries when operating with the AC mode for a longer period of time. Leaving the batteries in the compartment for a long time may cause leakage, which may lead to damage of the unit.

2. No batteries are needed when operating with the AC adapter.

Applying the arm cuff

1. Plug in the cuff connecting tube into the unit.
2. Unwrap the arm cuff, leaving the "Index" end of the cuff through the D-ring of the cuff.

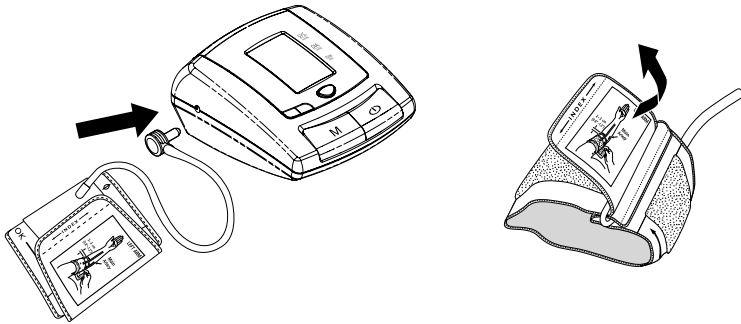

3. Put your left arm through the cuff loop. The "OK" range indication should be positioned closer to yourself with the rubber tube pointing in the direction of your arm. Position the artery mark (Φ) over the main arteries (on the inside of your arm) in the upper arm.

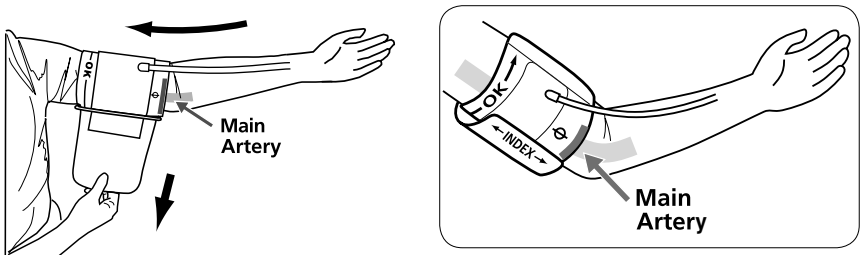

4. Turn your left palm upward and place the edge of the arm cuff at approximately 2 to 3 cm above the inner side of the elbow joint. Tighten the cuff by pulling the "Index" end of the cuff.

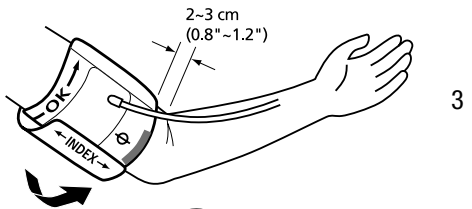

5. If the Index line falls within the OK range, indicated at the edge of the cuff, this cuff suitable for your use. If the Index line falls out the OK range, you may need a special cuff measurement. Please visit www.lumiscopes.net contact our service department at 800-672-8293 for more information regarding

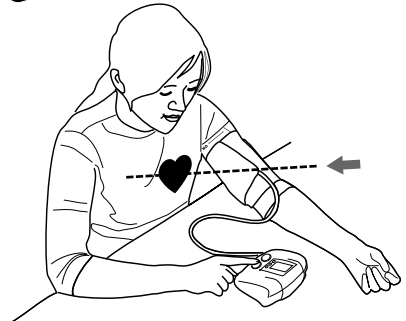



is
of
for
or
1-

Measurement Procedure

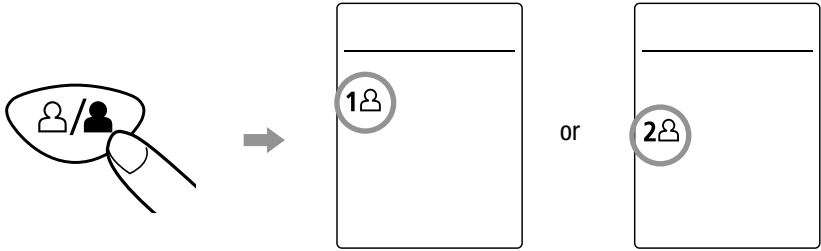
1. Press the User-Switching key to select Memory Zone 1 or Memory Zone 2.



After a memory zone is selected, press the  button to reset the monitor so it can start measurement in the chosen memory zone.

2. Press the  button. All digits will light up, checking the display functions. The checking procedure will be completed after about 2 seconds.

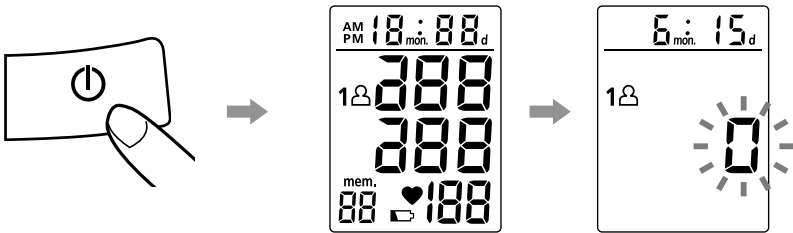

3. After all symbols appear, the display will show a blinking "0". The monitor is now ready to measure and will automatically inflate the cuff slowly to start measurement.

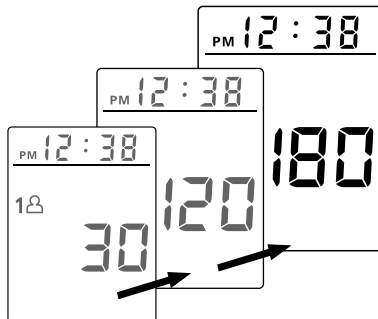

Measurement Procedure

4. When the measurement is completed, the cuff will automatically deflate. Systolic, diastolic and pulse will be shown simultaneously on the LCD screen. **The measurement is then automatically stored into the pre-designated memory zone.**

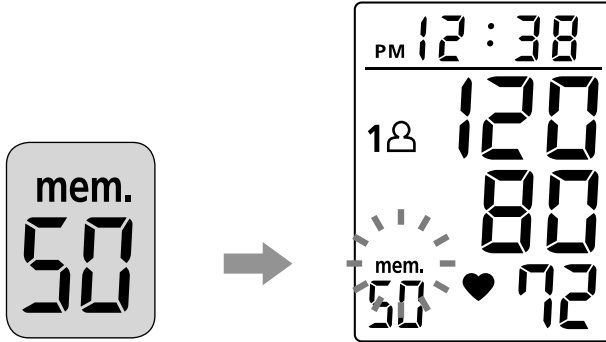

Note:

1. This monitor automatically switches off approximately **1 minute** after last measurement.
2. To interrupt the measurement, simply press any key. The cuff will deflate immediately after any key is pressed.
3. Do not talk or move your arm or hand muscles during measurements.

Recalling Values from Memory

1. The Monitor has two Memory Zones (1 and 2). Each zone can store up to 50 measurements.



2. To read memory values from a selected Memory Zone, use the “User-Switching Key” to select a Memory Zone (1 or 2) from which you want to recall values from. Then, press the “M” key, and the values will be shown on the LCD display with an assigned memory sequence number.

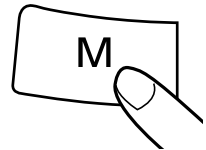

3. The monitor will display an average of the previous measurements first. Every new press of the “M” key calls for one set of prior values stored. Latest memory will be recalled first. The calculated average will be applied to a maximum of the last 3 memories.

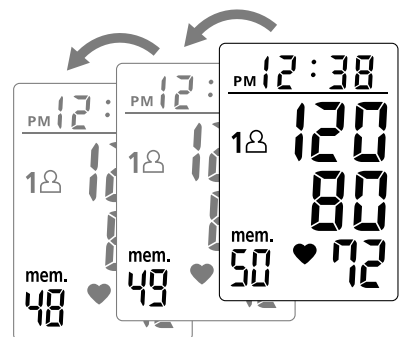
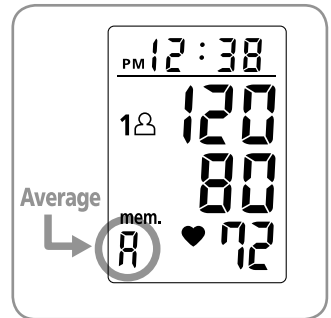

Clearing Values from Memory

1. Press the User-Switching key to select the memory zone 1 or memory zone 2.



2. Continue to press and hold the “M” key for approximately 5 seconds, and the data in the pre-designated memory zone will be erased automatically.

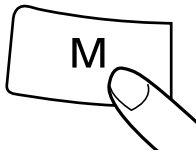

Press “M” Key for
5 seconds to clear all
memories

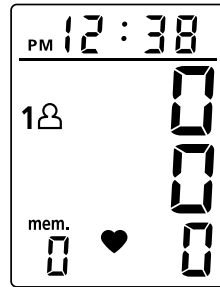

Note : The data in both memory zones (zone 1 and zone 2) will be erased if any of the batteries are removed, or if the AC adapter is disconnected from the unit or unplugged from the outlet. (It is suggested that users record their data on the Blood Pressure Log before removing or replacing batteries.)

Time Adjustment

1. To adjust the date/ time in the monitor, press the Ⓞ key . The display will show a blinking number showing the month.
2. Change the month by pressing the “+” Key. Each press will increase the number by one in a cycling manner. Press th Ⓞ Key. again to confirm the entry, and the screen will show a blinking number representing the date.
3. Change the date, the hour, and the minute as described in Step 2 above, using the “Ⓞ” Key to change and the “+” Set Key to confirm the entries.
4. A “0” will reappear as the Blood Pressure Monitor is ready for measurement again.

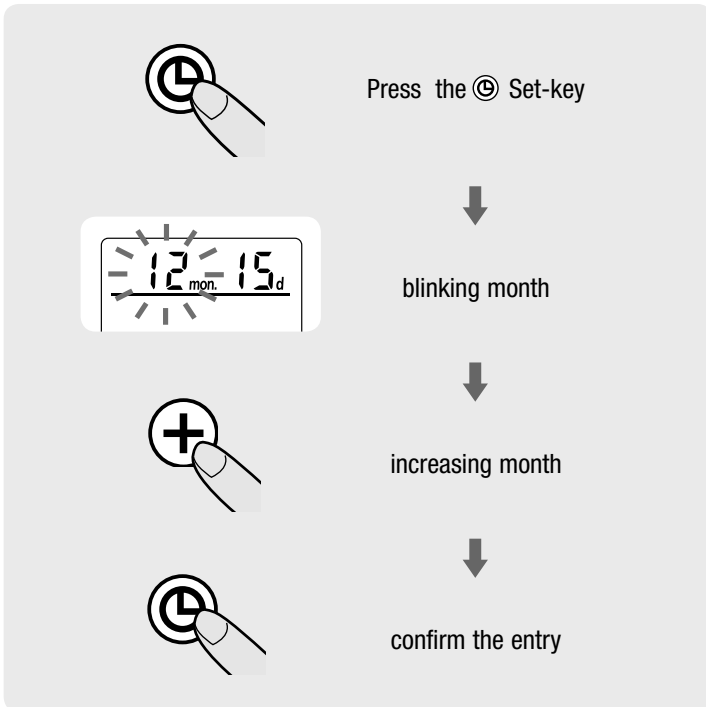

Helpful Tips

Here are a few helpful tips to help you obtain more accurate readings:

- Do not measure your blood pressure immediately after consuming a large meal. Wait at least one hour after eating to take a measurement.
- Do not smoke or drink alcohol before measuring your blood pressure.
- You should not be physically tired or exhausted while taking a measurement.
- It is important that you relax during measurement. Take 15-minute rest before a reading.
- Do not take measurements if you are under stress or under tension.
- Take your blood pressure at normal body temperature. If you are feeling cold or hot, wait a while before taking a measurement.
- If the monitor is stored at very low temperature (near freezing), have it placed at a warm location for at least one hour before using it.
- Wait about 5 minutes in between consecutive measurements.

Troubleshooting

If any abnormality should arise during use, please check the following points.

| Symptom | Check Point | Correction |
|--|---|--|
| No display when the ON/OFF/START key is pressed | Have the batteries run down? | Replace them with four new batteries or use AC Adapter. |
| | Have the batteries' polarities been positioned incorrectly? | Re-insert the batteries in the correct positions. |
| EE mark shown on display or the blood pressure value is displayed excessively low (high) | Is the cuff placed correctly? | Wrap the cuff properly so that it is positioned correctly. |
| | Did you talk or move during measurement? | Measure again quietly. |
| | Did you vigorously shake the cuff during measurement? | |

Note: If the unit still does not work, return it to your dealer or contact our repair department. Under no circumstance should you disassemble and attempt to repair the unit by yourself.

Cautionary Notes:

1. The unit contains high-precision assemblies. Therefore, avoid extreme temperatures, humidity, and direct sunlight. Avoid dropping or strongly shocking the main unit, and protect it from dust.
2. Clean the blood pressure monitor body and the cuff carefully with a slightly damp, soft cloth. Do not press. Do not wash the cuff or use chemical cleaner on it. Never use thinner, alcohol or petrol (gasoline) as cleaner.
3. Leaky batteries can damage the unit. Remove the batteries when the unit is not used for a long time.
4. The unit should not be operated by children so to avoid hazardous situations.
5. If the unit is stored near freezing, allow it to acclimate at room temperature before use.
6. Your Lumiscope Model 1131 is not field serviceable. You should not use any tool to open the device nor should you attempt to adjust anything inside the device. If you have any problems, please contact the store or the doctor from whom you purchased Lumiscope Model 1131 or contact the Lumiscope Repair Department at 1-800-672-8293.
7. For users diagnosed with common arrhythmia (atrial or ventricular premature beats or atrial fibrillation), diabetes, poor circulation of blood, kidney problems, or for users who have suffered from stroke, the device might not be suitable for use.
8. Do not use on unconscious patients.

Specifications:

| | |
|-----------------------|---|
| Measurement Method | : Oscillometric |
| Measurement Range | : Pressure: 20~280mmHg; Pulse: 40~180 beats/ minute |
| Pressure Sensor | : Semi conductor |
| Accuracy | : Pressure: ± 3 mmHg; Pulse: $\pm 5\%$ of reading |
| Inflation | : Pump Driven |
| Deflation | : Automatic Pressure Release Valve |
| Memory capacity | : 50 memories for each memory zone |
| Auto-shut-off | : 1 minute after last button operation |
| Operation Environment | : Temperature: 5 °C ~ 45 °C (41 °F~113 °F); Humidity: 40 ~ 85% |
| Storage Environment | : Temperature: -10 °C ~ 60 °C (14 °F~140 °F); Humidity: 10 ~ 95% |
| Power Source | : 6V DC four LR06 (AA) Batteries |
| Dimensions | : 137 (L) X 140 (W) X 63 (H) mm |
| Weight | : 450g (G.W.) (No Batteries) |
| Arm circumference | : Adult: 24 ~36 cm (9.4"~14.2") (standard) : Large adult: 34 ~46 cm (13.4"~18.1") (standard) |
| K.B. | : Short time operation 2 minutes. |

*Specifications are subject to change without notice.

Two-Year Limited Warranty:

Lumiscopce guarantees this product free from defects in material and workmanship for a period of two years from the date of purchase, except as noted below:

This Lumiscopce product warranty does not cover damage caused by misuse or abuse; the attachment of any unauthorized accessory; alteration to the product; or any other conditions whatsoever that are beyond the control of Lumiscopce. Lumiscopce shall not be responsible for any type of incidental, consequential, or special damage. All implied warranties, including, but not limited to those implied warranties of fitness and merchantability, are limited in the total duration of two years from the original date of purchase.

To obtain warranty service on your Lumiscopce Blood Pressure Monitor, please contact the Lumiscopce Repair Department at 1-800-672-8293 or visit www.lumiscopce.net. There is a \$15 fee for return shipping and handling. Please make checks payable to The Lumiscopce Co., Inc.

Upon receipt, Lumiscopce will repair or replace, as appropriate, the blood pressure monitor and return it to you. Warranty is solely through the Lumiscopce Repair Department. Service of this product by anyone other than the Lumiscopce Repair Department voids warranty.

In the event that Lumiscopce does not abide by the terms of this warranty the consumer may seek breach of contract remedies in the New York State Federal courts of law. This warranty gives you specific legal rights and you may also have other rights which vary from state to state.

Some states do not allow the exclusion or limitation of incidental or consequential damages, so the above limitation may not apply to you.

Distributed By:
The Lumiscopce Co., Inc.
www.lumiscopce.net
Repair Department: 1-800-672-8293
Made and Printed in China

Free Manuals Download Website

<http://myh66.com>

<http://usermanuals.us>

<http://www.somanuals.com>

<http://www.4manuals.cc>

<http://www.manual-lib.com>

<http://www.404manual.com>

<http://www.luxmanual.com>

<http://aubethermostatmanual.com>

Golf course search by state

<http://golfingnear.com>

Email search by domain

<http://emailbydomain.com>

Auto manuals search

<http://auto.somanuals.com>

TV manuals search

<http://tv.somanuals.com>