

INSTALLATION AND OPERATING INSTRUCTIONS

LUXPRO PH521 5/2-Day Programmable Heat Pump Thermostat

52125

Lux Products Corporation - Mt. Laurel, New Jersey 08054 - <http://www.luxproproducts.com>

WARNING: Use Energizer® or DURACELL® Alkaline Batteries Only.

Energizer® is a registered trademark of Eveready Battery Company, Inc.
DURACELL® is a registered trademark of The Gillette Company, Inc.

Thank you for your confidence in our product. To obtain the best results from your investment, please read these instructions and acquaint yourself with your purchase. Follow the installation procedures carefully, and save these instructions for future reference. This will save you time and minimize the chance of damaging either the thermostat or the systems that it controls. NOTE: These instructions may contain information beyond that required for your particular installation.

SYSTEM COMPATIBILITY:

This thermostat can be used with most 24 volt: single-stage heat pumps, and 2-heat / 1-cool heat pump systems with auxiliary and/or Emergency heat. Second Stage Dual Fuel Systems Capable.

This thermostat cannot be used to control: conventional heating and cooling systems, 2/3-wire zone valves, or 120/240 volt (line voltage) heating or cooling systems. Ask your dealer for other LUXPRO® thermostats to control those systems.

TOOLS YOU MAY NEED:

Screwdrivers, wire stripper / cutter, and possibly a drill with assorted bits (new installations only).

REMOVAL OF OLD THERMOSTAT:

- Turn OFF the electricity to all heating and cooling components. Do not turn the electricity back on until all work is completed.
- Remove the front portion of your old thermostat to expose the wiring connections.
- Write down the letters printed near each wire terminal that is used, and also the color of each wire that is connected to it. Self-adhesive wire labels are also enclosed.
- Carefully remove the wires one at a time, and bend them in a manner so that they do not fall back inside the wall. Do not allow bare wire ends to touch each other.
- Loosen the mounting screws for the old thermostat and carefully remove it from the wall.

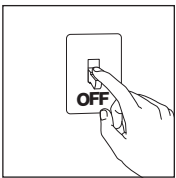

THERMOSTAT MOUNTING LOCATION:

On replacement installations, mount the new thermostat in place of the old one unless the conditions listed below suggest otherwise. On new installations, please follow these general guidelines:

- Mount the thermostat on an inside wall, about 5 ft. (1.5m) above the floor.
- Do not locate the thermostat where air circulation is poor such as in a corner, alcove, or behind a door that is normally left open.
- Do not locate the thermostat where unusual heating or cooling conditions may be present, such as: direct sunlight, above a lamp, television, or radiator, or on a wall next to an exterior door or window.
- Do not locate in a damp environment, as this can lead to corrosion that may shorten thermostat life.
- If painting or construction work is still ongoing, cover the thermostat completely or wait until this work is complete before installation.

INSTALLATION OF NEW THERMOSTAT:

- Strip wire insulation leaving only 3/8 in. (9.5mm) bare wire ends, and clean off any corrosion present.
- Fill the wall opening with non-combustible insulation to prevent drafts from affecting the thermostat's normal operation.
- Route the wires through the opening in the new thermostat base plate, and hold the base against the wall. Try to line up the screw holes from the prior thermostat, and install the mounting screws.
- If the previous holes cannot be used, hold the thermostat base against the wall so that it appears straight and level (position the base for best appearance) and mark for the new screw holes. Attach the base to the wall using the screws provided (use the supplied plastic anchors if needed when mounting to a soft material such as drywall).

WIRING TERMINAL CONNECTIONS:

- When attaching the wires to the thermostat, please ensure that the bare wire ends are held ALL the way into the terminal block while the screw is being tightened.
- Securely tighten all of the electrical terminal screws, including any unused ones. Be careful not to over tighten the screws, they only need to be snug.

**** Complete heating and/or cooling system wiring can be found in the WIRE IDENTIFICATION AND WIRING SCHEMATICS section of this instruction sheet. The schematics shown provide component information for brand new installations or for unreferenced wires.**

SYSTEM CONFIGURATION AND SETUP OPTIONS:

On the circuit board, there are hardware settings called "jumpers". Each jumper has 3 metal pins, and a small black cap. The cap is moved to either the top two pins or the lower two pins. Changes to these options are recognized every time the EMER/HEAT/OFF/COOL mode switch is moved.

JP1 (CTRL): [UP = Manual Operation] The thermostat operates manually, and only shows the room and set temperatures. In this mode, there are no temperature programs, days of the week, or clock times. [DOWN = Program Operation, default] The thermostat follows four temperature programs: MORN, DAY, EVE, and NITE. Each period has a start time and a set temperature.

JP2 (SCALE): [UP = Celsius] This setting displays all temperature values in C° degrees. [DOWN = Fahrenheit, default] All temperature values are displayed in F° degrees.

JP3 (BATT): [UP = None] This setting only applies if you are NOT using batteries in the thermostat, and are powering the thermostat entirely from the system ("C" wire terminal). [DOWN = Batt, default] This setting, regularly monitors the battery level, and shows "LOW BAT" on the screen if the batteries need replaced. Use this setting at all times when batteries are physically present in the thermostat.

JP4 (B/O): [UP = "B"] This setting energizes the "B/O" wire terminal at all times in HEAT mode, and is not energized in COOL mode. This setting is not typical, and is only needed for certain brands of heat pump units, such as: Rheem, Ruud, Goettl, and Bard. [DOWN = "O", default] This setting energizes the "B/O" wire terminal at all times in COOL mode, and is not energized in HEAT mode. This setting is used for the majority of heat pump units with the exception of only a few brands.

JP5 (HP MODE): [UP = Dual] Use this setting if you are using a "fossil fuel" type furnace as your Auxiliary 2nd heat stage (connected to the "W2" terminal). When the 2nd heating stage is called for, the first heating stage (heat pump "Y" terminal) is de-energized. Types of systems that would typically use the "Dual" fuel setting would be: natural gas furnace, propane furnace, and oil furnace. [DOWN = Elec, default] This setting is used for the majority of traditional heat pump applications, which use an electric heating element as the Auxiliary heat stage, and also as the Emergency heat device (connected to the "E" terminal) if present. This setting always runs the system's blower fan ("G" terminal) when heating is called for, and is usually required for electric heating elements.

JP6 (FAN): [UP = Gas] This setting lets the heating system control the blower fan automatically by itself. Types of systems that would typically use the "Gas" fan setting would be: natural gas furnace, propane furnace, and oil furnace. [DOWN = Electric / HP, default] This setting runs the system's blower fan when heat is called for, and is required for systems that do not control their own fan while in HEAT mode. Heat pump systems, and units with an electric heating element typically require this setting.

THERMOSTAT FRONT PANEL:

EMER / HEAT / OFF / COOL, SYSTEM MODE SWITCH: Set this switch to HEAT to control your heating system, and COOL to control your cooling system. To disable the heat pump unit and operate only on your Auxiliary/Emergency heating source, use the EMER position. The OFF position will disable both the heating and cooling units.

AUTO / ON, FAN SWITCH: When this switch is in AUTO, the blower fan will automatically cycle on and off by itself when heating or cooling is running. When in the ON position, the blower fan will run constantly with or without a demand for heating or cooling, even in OFF mode.

MULTI-FUNCTION, SET SLIDE SWITCH: Unless other settings are being adjusted, this switch should always remain in the RUN position for the thermostat to control temperature. When this switch is in the DAY/TIME position, the day and clock can be changed. When this switch is in the WEEKDAY or WEEKEND positions, the heating and cooling temperature program periods can be adjusted. NOTE: this switch is only used in "Program" mode. When the thermostat is used in "Manual" control mode, all four of the switch positions will act like the RUN position.

RESET BUTTON: There is a small recessed push button located to the left of the DOWN button, which can be pressed with a pen/pencil, paper clip, or similar object. A single press of this button causes the LCD display screen to become fully populated, the heating/cooling load relay to cycle off, and performs an internal system check of the thermostat components. If your thermostat is acting in an erratic manner, pressing the Reset button may remedy this behavior. If your thermostat continues to act erratically, a Full Software Reset may be needed. This and other additional features that can be accessed using the same Reset button, which are explained in the ADVANCED FEATURES section of this manual.

THERMOSTAT BASIC OPERATION:

SET DAY AND TIME: Place the Set Slide Switch into the DAY/TIME position. With the day flashing, press UP or DOWN to set the day of the week. Press NEXT and the clock will start flashing. Use UP or DOWN to set the time, making sure the AM/PM indication is correct. Holding UP or DOWN will make the clock digits scroll rapidly. Return the Set Slide Switch to RUN.

HEATING AND COOLING: Basic operation of your heating or cooling system can be obtained with the Set Slide Switch in the RUN position and choosing either HEAT or COOL on the System Mode Switch. When the thermostat is first powered up, it will follow a default temperature routine that is preset from the factory (shown below).

PERIOD	HEAT MODE	COOL MODE
MORN	6:00 AM 70 °F (21 °C)	6:00 AM 78 °F (26 °C)
DAY	8:00 AM 62 °F (17 °C)	8:00 AM 85 °F (29 °C)
EVE	6:00 PM 70 °F (21 °C)	6:00 PM 78 °F (26 °C)
NITE	10:00 PM 62 °F (17 °C)	10:00 PM 82 °F (28 °C)

When the thermostat is in Heat mode, the word "HEAT" will be present on the screen. When the thermostat is calling for your heating system to run, the word "HEAT" will be flashing. If there is a large thermal demand present which is greater than the first stage of heating can accommodate, then a second stage of heating ("W2" terminal) will be activated, flashing the word "AUX" and "HEAT" on the display. When the thermostat is in Cool mode, the word "COOL" will be present on the screen. When the thermostat is calling for your cooling system to run, the word "COOL" will be flashing.

EMERGENCY HEAT: Moving the System Mode switch to the EMER position will activate Emergency Heat mode. While in Emergency Heat mode, the words "HEAT" and "AUX" will both be shown in the display screen. When Emergency Heat is currently running, the word "AUX" will flash on the screen.

Emergency Heat mode will prevent the first stage of your heat pump system from turning on, and use only the "E" terminal as the primary heating source. This will not only prevent the heat pump from wasting energy if outdoor temperatures are too low to support efficient operation, but it could also prevent damage to the heat pump if outside temperatures are below the manufacturer's recommendations. As every heat pump has different operating characteristics, you should refer to your heat pump literature to determine when to disable the heat pump and run in Emergency Heat mode.

TEMPERATURE OVERRIDE: While in Program mode, the set temperature can be temporarily changed by pressing UP or DOWN. The set temperature will return to the programmed value stored in memory when the start time of the next upcoming program period is reached (MORN, DAY, EVE, NITE). While a Temporary Override is in effect, the word OVERRIDE will be shown in the display screen. An Override may be cancelled by moving the mode switch to OFF, then back to HEAT or COOL.

MINIMUM RUN TIME: The thermostat has an internal time delay of 5 minutes between load-on and load-off activations to prevent heating or cooling system damage, which can occur from very frequent cycling. If heating or cooling does not turn on right away with a change in set temperature, please wait 5 minutes and the system should resume normal operation.

TEMPERATURE HOLD: A Temperature Hold is used for maintaining a fixed set temperature. Once a Hold is initiated, the thermostat will maintain the set temperature indefinitely. A Hold may be used for days, weeks, or even months at a time. To enter Hold mode: press HOLD one time and the word Hold will appear in the display. To cancel a Hold, press HOLD one more time.

STATIC NOTICE: This thermostat is protected against normal static electric discharges, however to minimize the risk of damaging the unit in extremely dry weather, please touch a grounded metal object (light switch) before touching your thermostat.

LCD DISPLAY BACKLIGHT: The display screen has backlighting that will assist viewing at nighttime, or in locations with low light levels. A press of any button on the front panel will light the display for approximately 10 seconds. Any button presses that occur while the backlight is on, will reset the timer, causing the screen to remain illuminated for an additional 10 seconds.

TEMPERATURE PROGRAMS:

This thermostat has 4 separate program periods for both Heat and Cool mode, they are: MORN, DAY, EVE, and NITE. Each period ends at the start time of the following period. The heat programs are set in HEAT mode, and the cool programs are set in COOL mode. NOTE: Emergency Heat mode uses the regular Heat mode temperature programs.

WEEKDAY PROGRAMS: Move the Set Slide switch to WEEKDAY. You will be programming all five weekdays at the same time. Use UP or DOWN to adjust the start time for the MORN period, then press NEXT to advance. Use UP or DOWN to adjust the set temperature for the MORN period, then press NEXT to advance. Now adjust the start time and set temperature for the DAY period, pressing NEXT after each to advance. Continue with these same steps to adjust the start times and set temperatures for the EVE and NITE program periods. When you are finished setting all four periods, continue pressing NEXT to review your entries for all 4 periods. Move the Set Slide switch to the RUN position if you are finished, or to WEEKEND to adjust the periods for Saturday or Sunday periods.

WEEKEND PROGRAMS: Move the Set Slide switch to WEEKEND. You will be programming both Saturday and Sunday at the same time. You will begin with the start time for the MORN period, and use the same steps that you did for setting the Weekday periods, pressing NEXT to advance through the values. Return the Set Slide switch to the RUN position when you are finished.

ADVANCED FEATURES:

TEMPERATURE SWING: The amount of temperature variation between load-on and load-off is changed by adjusting the swing setting. The default value is #1, and the adjustment range is from #1 to #9. A smaller swing number makes the temperature control more precise and constant, and increases the number of cycles per hour. A larger swing number will produce a greater variation between load-on and load-off events, and decreases the number of cycles per hour. To adjust the swing: place the Set Slide switch in the RUN position, and press both NEXT and HOLD at the same time. Use UP or DOWN to change the setting, then press NEXT when finished.

TEMPERATURE CALIBRATION: This thermostat is calibrated at the factory and in most cases, alterations to this setting should not be required. The Calibration feature allows you to manually offset the room temperature measurement by as much as plus or minus 5°F (3°C) degrees from its original value. 0°F (0°C) is the default setting. To adjust the Calibration: place the Set Slide Switch in the RUN position, and the System Mode switch in the OFF position. Press both UP and DOWN together for at least 4 seconds. Use UP or DOWN to change the setting, then press NEXT when finished.

KEYPAD LOCKOUT: You can lock the front panel buttons to prevent unauthorized tampering of your thermostat settings.

TEMPERATURE LIMIT STOPS: There are two independent set temperature stops: a maximum heat set temperature, and a minimum cool set temperature. Each of these temperature stops is user adjustable in one-degree increments. The heat limit stop prevents the set temperature from being adjusted higher than the heat limit setting. The cool limit stop prevents the set temperature from being adjusted lower than the cool limit setting.

COMPRESSOR PROTECTION BYPASS: This optional feature permits the installer or service technician to temporarily disable the built in compressor protection delays. This is most useful for diagnosing and testing the heating and cooling systems after installation is complete, and should not be used during normal operation. To activate this feature: place the Set Slide Switch in the RUN position, and perform a single press of the RESET button (located to the left of the DOWN button). The screen will change to become fully populated with all segments shown. After the screen returns to a normal display, enter the following four-button sequence, using a single press for each button: UP, UP, DOWN, DOWN. You should leave approximately one second between button presses. The cooling terminal can now be activated one time without waiting for the delay, and once activated the thermostat will return to normal run mode with delays present. When you use this Compressor Protection Bypass procedure, no changes will be made to other thermostat settings or options.

FULL SOFTWARE RESET: This complete reset returns all heating and cooling temperature programs, and all user changeable software options, to their factory default values. It is recommended that you write down your current heating and cooling program values for reference prior to performing a software reset. To perform a software reset: move the System Mode switch in the OFF position, and the Set Slide switch to the RUN position. Perform a single press of the RESET button (located to the left of the DOWN button). The screen will change to become fully populated with all segments shown. After the screen returns to a normal display, enter the following four-button sequence, using a single press for each button: UP, DOWN, UP, DOWN. You should leave approximately one second between button presses. After the software reset steps have been performed, you will not notice anything different on the screen, and the thermostat will be ready for normal operation (you may wish to adjust the heating and cooling programs to suit your temperature preferences).

BATTERY REPLACEMENT:

This thermostat is powered by two "AA" Alkaline batteries. The batteries should be replaced AT LEAST once per year (or sooner, if "LOW BAT" battery symbol appears in the lower left portion of the display screen). The batteries are located on the back of the circuit board, and can be accessed by pulling the front portion of the thermostat straight outwards and removing it from the wall. When installing new batteries, we recommend using only brand new Energizer® or DURACELL®, "AA" size alkaline batteries. Please observe the polarity markings shown in the battery compartment to ensure proper installation. When finished, line up the front of the thermostat to the base, and firmly press together to latch properly.

TECHNICAL SUPPORT:

If you have any problems installing or using this thermostat, please carefully and thoroughly review the instruction manual. If you require assistance, please contact our Technical Assistance department at 856-234-8803 during regular business hours between 8:00AM and 4:30PM Eastern Standard Time, Monday through Friday. You can also receive technical assistance online anytime day or night at <http://www.luxproproducts.com>. Our web site offers you answers to the most common technical questions, and also permits you to email your questions to our technical support staff at your convenience.

LIMITED WARRANTY:

If this unit fails because of defects in materials or workmanship within three years of the date of original purchase, LUX will, at its option, repair or replace it. This warranty does not cover damage by accident, misuse, or failure to follow installation instructions. Implied warranties are limited in duration to three years from the date of original purchase. Some states do not allow limitations on how long an implied warranty lasts, so the above limitation may not apply to you. Please return malfunctioning or defective units to the location from which the purchase was made, along with proof of purchase. Please refer to "TECHNICAL ASSISTANCE" before returning thermostat. Purchaser assumes all risks and liability for incidental and consequential damage resulting from installation and use of this unit. Some states do not allow the exclusion of incidental or consequential damages, so the above exclusion may not apply to you. This warranty gives you specific legal rights and you may also have other rights, which vary from state to state. Applicable in the U.S.A. and Canada only.

MERCURY WARNING AND RECYCLING NOTICE:

Mercury is considered to be a hazardous material. If this product is replacing a thermostat that contains mercury in a sealed tube, contact your local waste management authority for instructions regarding recycling and proper disposal. It may be unlawful in your state to place it in the trash.

HEAT PUMP TERMINAL CROSS REFERENCE CHART										
TABLEAU DE RÉFÉRENCE CROISÉE DE BORNE DE POMPE À CHALEUR										
TABLA DE REFERENCIA PARA LA TERMINAL DE LA BOMBA DE CALEFACCIÓN										
HEAT PUMP BRAND MARQUE DE POMPES À CHALEUR MARCA DE LA BOMBA DE CALEFACCIÓN	CORRESPONDING TERMINALS BORNES CORRESPONDANTES TERMINALES CORRESPONDIENTES								TAPE OFF (NOT USED) RUBAN RETIRÉ (NON UTILISÉ) DESPRENDIMIENTO (NO UTILIZADO)	
	(E)	(G)	(Y)	(R)	(O)	(W2)	(B)	(C)	(L)	()
ARCO / Friedrich	X2	G	Y	RC		W2	B	C	L	
ARCO / Snyder General	E	G	Y	R	O	W1		C	X	
BARD	E	G	Y1	R		W2	B	X	L	
BARD, HP, WH, MHP, HPQ	E	G	Y	R		W2	W1	X	L	
BDP / BRYANT	E	G	Y	R	O	W1		C	F	
CARRIER	E	G	Y	R	O	Y1		C	L	
CARRIER 5Q	to W2	G	Y, W1	R	O	W2		C	L	
CARRIER 50Q, QT382	E	G	Y	R	O	W2		C	L	
COLEMAN		G	Y	RED	V	W2		BLACK		
GE BAY	X2	G	Y	R	O	W		B		T
HEIL-QUAKER / Whirlpool		G	Y	R	O	W		B		
JANITROL / Goodman	E	G	Y	R	O	W2		C		
LENOX TYPICAL HP6		F	M	V/VR	R	Y		X		
LENOX HP8	E	F	M	V/VR	R	Y		X		
LENOX HP9, 10	E	F	M	V/VR	R	Y		X	L	
LENOX HP16, 18, 19	E	F	M	V/VR	R	Y		X	L	
MAGIC CHEF PE	E	G	Y	R	O	W		C		
RHEEM / RUUD	E	G	Y	R		W2	B	X	L	
SNYDER GENERAL H-R811		G	Y	R	O	W1		C		
TRANE	X2	G	Y	R	O	W		B	F	T
WEATHERKING		G	W1	R	Y1	E		C		
WESCO	E	G	W1	R	Y1	W2		C		
WESCO / ADDISON	E	G	W1	R	O			X		
WESTINGHOUSE H50	E	G	Y	R	O	W		X	L1	
WESTINGHOUSE HE		F	C	V/VR		H2	Z	X		
WHITE RODGERS	E	G	Y	R	O	W2		C/X1	L	
YORK		G	Y	R	O	W		B	X	

WIRING DIAGRAM NOTES:

(Important, please read all notes before connecting wires)

1. If the information provided does not clearly represent your system configuration, please refer to the "TECHNICAL ASSISTANCE" section of this manual, and contact our support department before removing any of your existing thermostat wiring.
2. The DASHED lines in wiring diagram #1 are optional depending upon your system type. Single stage heat pumps will not have wires present for the "E" or "W2" terminals. For a 2-Heat / 1-Cool system with NO Emergency heat wire, AUX heat will be connected to "W2". A jumper wire may be placed in between the "E" and "W2" terminals to allow Emergency Heat Mode.
3. For Heat Pumps, use either the "B" or "O" wire, NOT BOTH.
4. If "Y" and "C" wires are both present, then "C" is a common wire.
5. If you have a "B" wire in your system that is used as a common wire, connecting it to the "B/O" terminal on this thermostat may damage your system and/or the thermostat.

NOTES DU DIAGRAMME DE CÂBLAGE :

(Il est important de lire toutes les notes avant de brancher les fils)

1. Si l'information fournie dans les diagrammes de câblage suivants ne représente pas clairement ou ne correspond pas à votre système, veuillez consulter la section de « L'AIDE TECHNIQUE » de ce manuel et nous contacter avant de retirer tout câblage actuel du thermostat.
2. Les lignes en TRAITs TIRÉS du diagramme de câblage 1 sont optionnelles et leur utilisation dépend de votre type de système. Les pompes à chaleur à un étage n'ont pas de fils pour les bornes « E » ou « W2. » Pour un système à 2 chauffage / 1 refroidissement SANS fil de chauffage d'urgence, la chaleur AUX sera branchée à « W2 ». Un fil de calier peut être placé entre les bornes « E » et « W2 » pour permettre l'utilisation du mode de chauffage d'urgence.
3. Pour les pompes à chaleur, utilisez soit le fil « B » ou « O », NON PAS LES DEUX.
4. Si vous avez les fils « Y » et « C », alors le « C » est le fil commun du système.
5. Si vous avez un fil « B » dans votre système et si ce fil est utilisé comme fil commun, le brancher à la borne « B/O » du thermostat pourrait endommager votre système et/ou le thermostat.

NOTAS DEL DIAGRAMA DEL CABLEADO:

(Importante, por favor lea todas las notas antes de conectar los cables)

1. Si la información que se proporciona en los siguientes diagramas de cableado no representa o no coincide claramente con la configuración de su sistema, por favor consulte la sección "ASISTENCIA TÉCNICA" de este manual y comuníquese con nosotros antes de retirar cualquier cable de su termostato.
2. Las líneas PUNTEADAS en el diagrama del cableado #1 son opcionales, dependiendo del tipo de sistema. Las bombas de calefacción de una fase no contienen cables para las terminales "E" ni "W2". Para un sistema de 2 fases de calefacción y una de enfriamiento, NO se conecta el cable de calefacción de emergencia ni el auxiliar (AUX) en la terminal "W2". Puede colocar un cable para formar un puente entre las terminales "E" y "W2" y permitir un modo de calefacción de emergencia.
3. Para las bombas de calefacción, utilice el cable "B" o el cable "O", NUNCA USE AMBOS.
4. Si tanto el cable "Y" como el "C" están presentes, entonces es más probable que el "C" sea el cable común del sistema.
5. Si en su sistema hay un cable "B" que se utiliza como cable común, no lo conecte a la terminal "B" ni "O" del termostato, pues podría dañar tanto su aparato como su sistema.

**(PH521) ENGLISH
WIRE IDENTIFICATION AND WIRING SCHEMATICS**

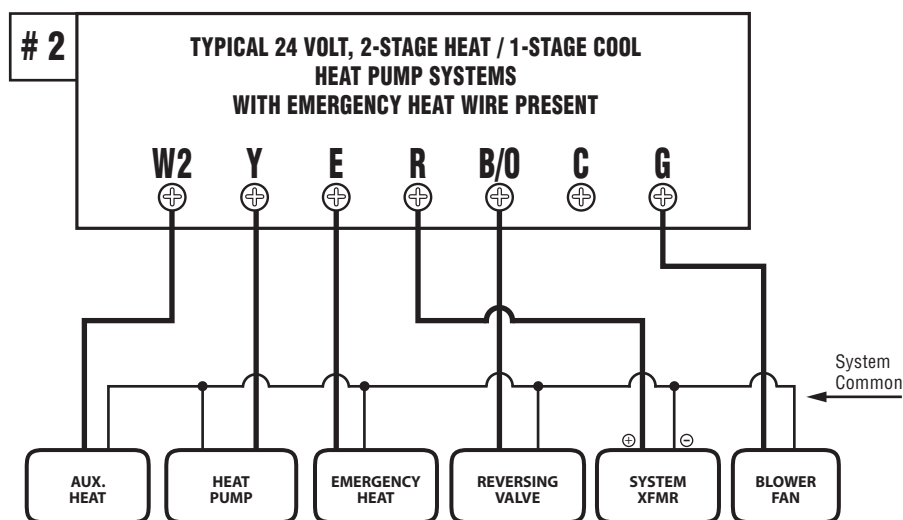
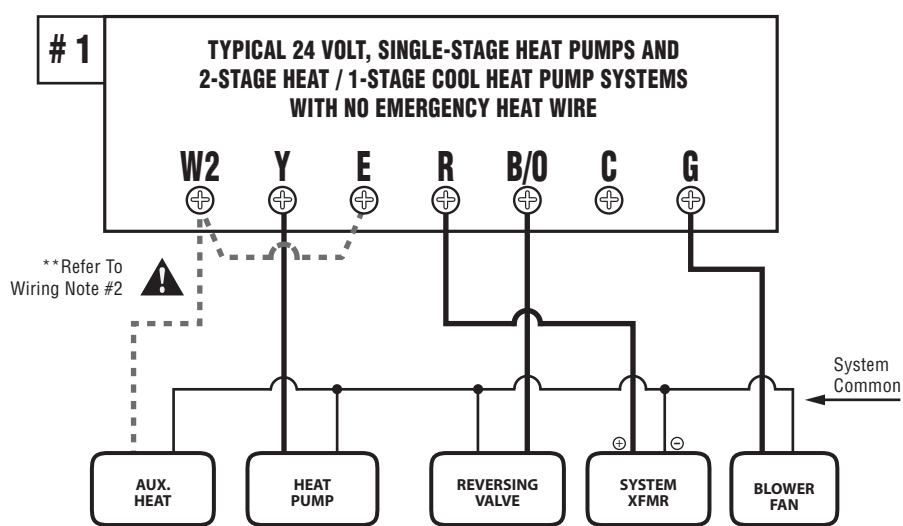

**(PH521) FRENCH
SCHÉMAS D'IDENTIFICATION DES FILS ET DU CÂBLAGE**

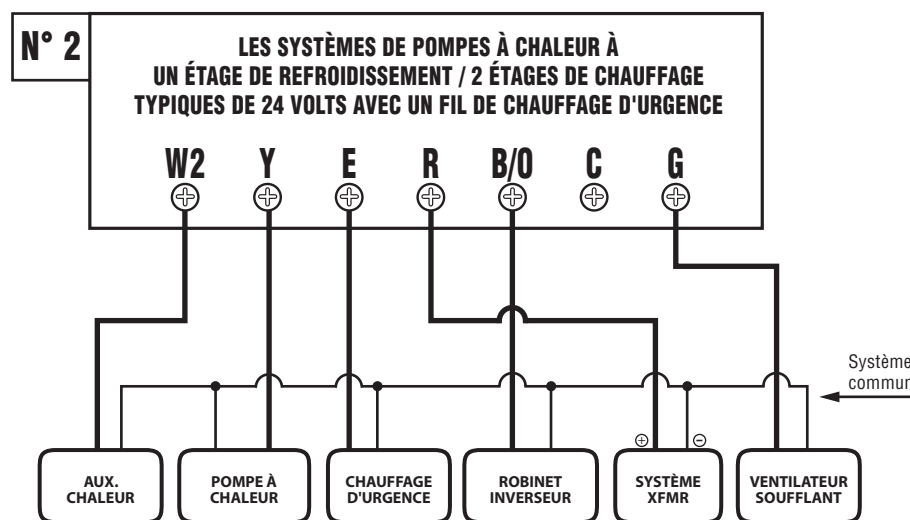
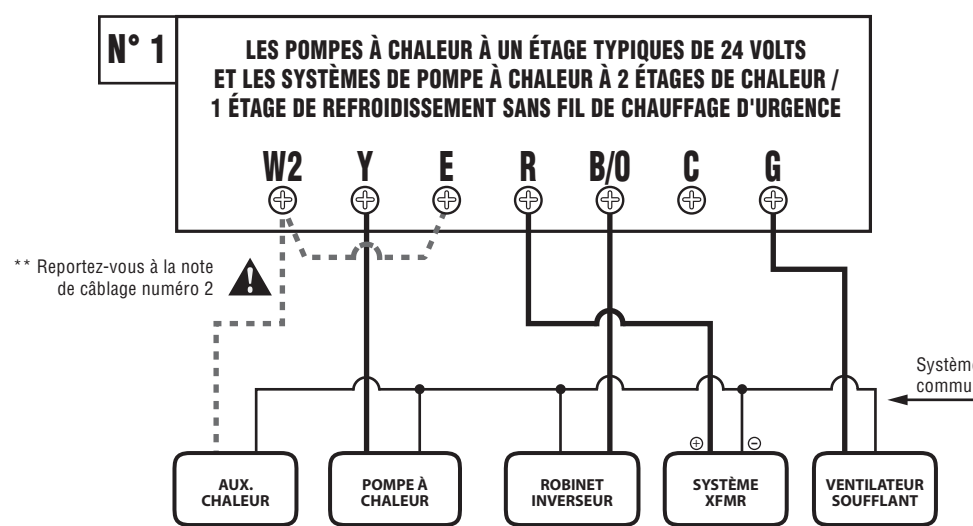

**(PH521) ESPAÑOL
IDENTIFICACION DE CABLES Y DIAGRAMAS DE CABLEADO**

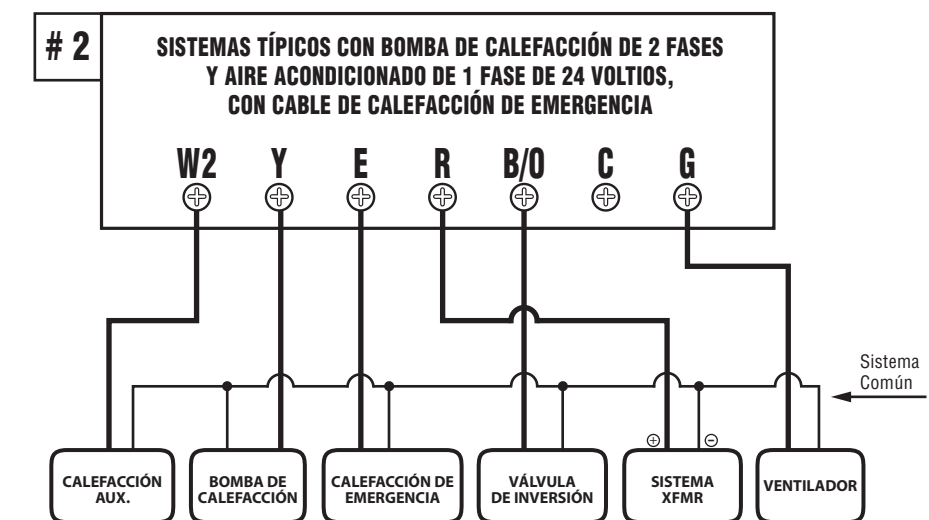
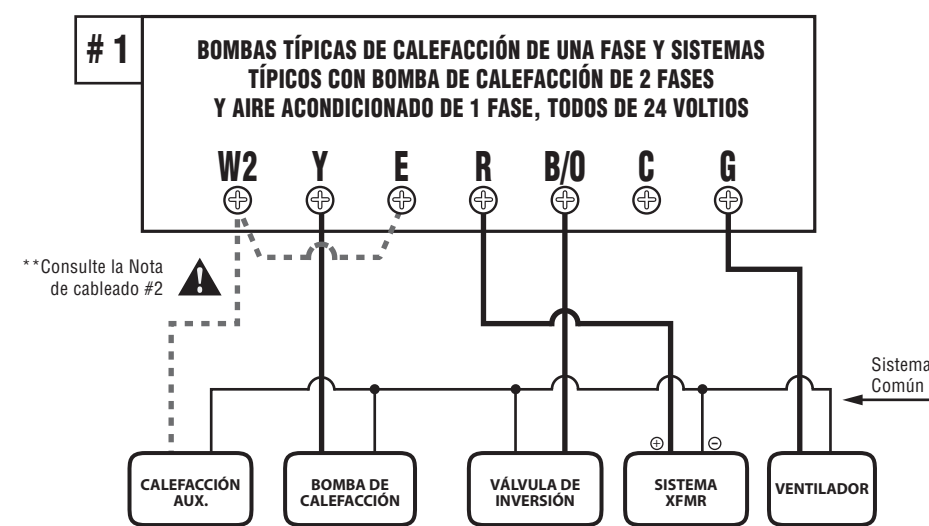

Free Manuals Download Website

<http://myh66.com>

<http://usermanuals.us>

<http://www.somanuals.com>

<http://www.4manuals.cc>

<http://www.manual-lib.com>

<http://www.404manual.com>

<http://www.luxmanual.com>

<http://aubethermostatmanual.com>

Golf course search by state

<http://golfingnear.com>

Email search by domain

<http://emailbydomain.com>

Auto manuals search

<http://auto.somanuals.com>

TV manuals search

<http://tv.somanuals.com>