

INSTALLATION AND OPERATING INSTRUCTIONS

LUX TX250 SERIES SMART TEMP ELECTRONIC THERMOSTAT

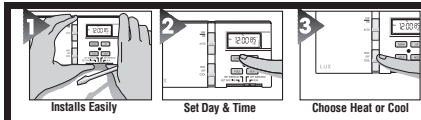

Easy as
1-2-3

Complete, Easy To Read Programming And Installation Instructions Inside

LUX PRODUCTS CORPORATION • Mt. Laurel, New Jersey 08054, USA 43374

WARNING: Use Energizer® or DURACELL® Alkaline Batteries Only.

Energizer® is a registered trademark of Eveready Battery Company, Inc.

DURACELL® is a registered trademark of The Gillette Company, Inc.

IMPORTANT!

READ INSTALLATION INSTRUCTIONS FIRST

Thank you for your confidence in our product. To obtain the best results from your investment, please read these instructions and acquaint yourself with your purchase before installing your new thermostat. Then follow the installation procedures, one step at a time. This will save you time and minimize the chance of damaging the thermostat and the systems it controls.

These instructions may contain information beyond that required for your particular installation. Please save for future reference.

FEATURES

- The TX250 can be used with most 24 volt gas, oil or electric heating and air conditioning systems, single-stage heat pumps or gas millivolt heating systems. It cannot be used with 120 volt heating systems or multistage heat pumps. Ask your dealer for other LUX thermostats to control those systems.
- The TX250 is programmable. There are four programming periods per day. Each period can be programmed separately.
- Easy to use Speed Slide.
- You can use the built-in time/temperature programs, or alter them to suit your schedule. The TX250 provides separate programming for weekdays and weekends — for both heating and cooling. You can override the programmed temperatures for as little as one programming period or for an entire vacation.
- In cool weather, when the system switch is set to HEAT, the TX250 may maintain cooler "set back" room temperatures to save energy. It will then change to warmer "comfort" settings — automatically, at specified times during the day.
- In warm weather, when the system switch is set to COOL, the TX250 may maintain warmer "set back" room temperatures to save energy. It will then change to cooler "comfort" settings — automatically, at specified times during the day.
- A liquid crystal display shows time, day of the week, and room and set temperatures.
- Temperature swing adjustment lets you fine-tune your system for maximum comfort and economy.
- A 2 or 5-minute minimum off time in COOL prevents your air conditioning system from being damaged.
- Two Energizer® or DURACELL® "AA" alkaline batteries (not included) are used to retain your time and temperature programs.

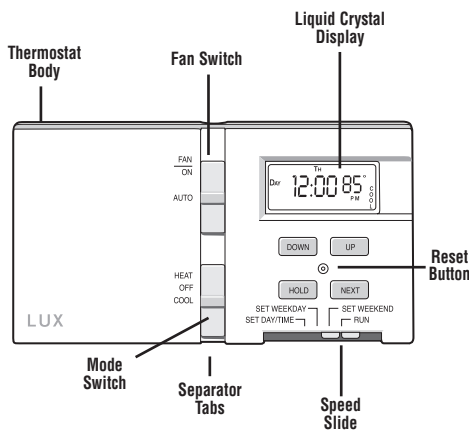

C A U T I O N

- Your thermostat is a precision instrument. Please handle it with care.
- Turn off electricity to the appliance before installing or servicing thermostat or any part of the system. Do not turn electricity back on until work is completed.
- Do not short (jumper) across electric terminals at control on furnace or air conditioner to test the system. This will damage the thermostat and void your warranty.
- All wiring must conform to local codes and ordinances.
- This thermostat is designed for use with 24 volt and millivolt systems. The thermostat should be limited to a maximum of 1.0 amps; higher amperage may cause damage to the thermostat. If you are in doubt, call your utility company.

INSTALLATION

CAUTION

To avoid electrical shock and to prevent damage to the furnace, air conditioner, and thermostat, disconnect the power supply before beginning work. This can be done at the fuse box, at the circuit breaker, or at the appliance.

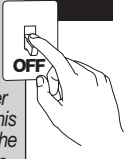

Please read all instructions carefully before beginning installation.

TOOLS REQUIRED

#1 Phillips screwdriver (small)

Drill with 3/16-in. (4.8mm) bit

THERMOSTAT LOCATION

On replacement installations, mount the new thermostat in place of the old one unless the conditions listed below suggest otherwise. On new installations, follow the guidelines listed below.

- Locate the thermostat on an inside wall, about 5 ft. (1.5m) above the floor, and in a room that is used often.
- Do not install it where there are unusual heating conditions, such as: in direct sunlight; near a lamp, radio, television, radiator, register, or fireplace; near hot water pipes in a wall; near a stove on the other side of a wall.
- Do not locate in unusual cooling conditions, such as: on a wall separating an unheated room; or in a draft from a stairwell, door, or window.
- Do not locate in a damp area. This can lead to corrosion that will shorten thermostat life.
- Do not locate where air circulation is poor, such as: in a corner or an alcove; or behind an open door.
- Do not install the unit until all construction work and painting has been completed.
- This thermostat does not require leveling.

REMOVING THE OLD THERMOSTAT

Switch electricity to the furnace and air conditioner OFF; then proceed with the following steps.



- Remove cover from old thermostat. Most are snap-on types and simply pull off. Some have locking screws on the side. These must be loosened.
- Note the letters printed near the terminals. Attach labels (enclosed) to each wire for identification. Remove and label wires one at a time. Make sure the wires do not fall back inside the wall.

CAUTION

Read instructions carefully before removing any wiring from existing thermostat. Wires must be labeled before they are removed. When removing wires from their terminals, ignore the color of the wires since these may not comply with the standard.

- Loosen all screws on the old thermostat and remove it from the wall.

MOUNTING THE TX250 ON THE WALL



- Strip insulation 3/8 in. (9.5mm) from wire ends and clean off any corrosion.

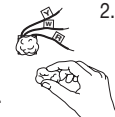

- Fill wall opening with non-combustible insulation to prevent drafts from affecting the thermostat.

- Cup and hold thermostat body and left tab in place with left hand. Separate tabs with right hand.

C A U T I O N

Be careful not to drop the body or disturb electronic parts.



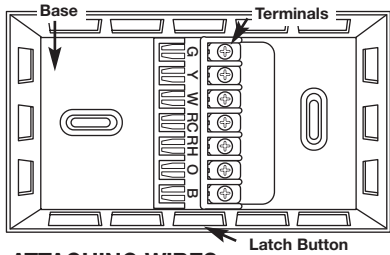

NOTE
If you are mounting the base to a soft material like plasterboard or if you are using the old mounting holes, the screws may not hold. Drill a 3/16-in. (4.8mm) hole at each screw location, and insert the plastic anchors provided. Then mount the base as described below.

ATTACHING WIRES

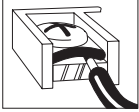

4. Hold the base against the wall, with the wires coming through wherever it is convenient for wiring. Route the wires to the terminal block. Position the base for best appearance (to hide any marks from an old thermostat). Attach the base to the wall with the two screws provided.

C A U T I O N
Do not allow wires to touch each other or parts on thermostat. Wires must be trapped between black spacer and brass terminal. Also, be sure to securely tighten all 7 electrical terminal screws.

WIRING DIAGRAMS

HEATING SYSTEMS

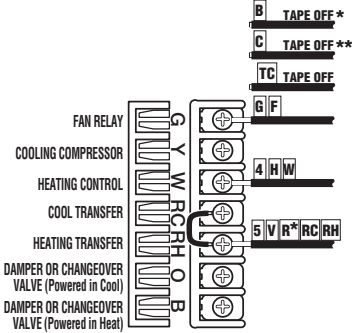

* If replacing a Honeywell TM-11, tape off wire "R"; connect wire "B" to terminal "RH".
** If replacing a Honeywell thermostat with a clock wire "C", tape off wire "C".

COOLING SYSTEMS

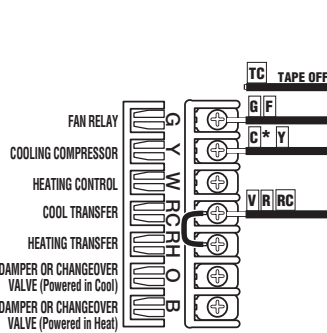

* If both "Y" and "C" wire are present, tape off "C" wire.

HEATING / COOLING SYSTEMS
4- or 5-WIRE WITH ONE TRANSFORMER

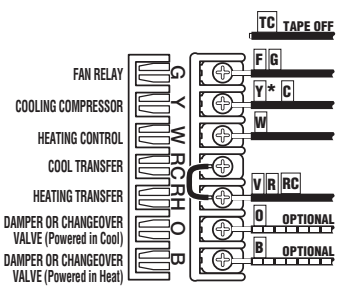

* If both "Y" and "C" wire are present, tape off "C" wire.

HEATING / COOLING SYSTEMS
5- or 6-WIRE WITH TWO TRANSFORMERS

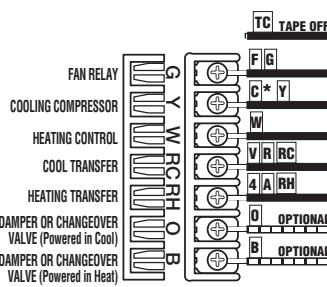

* If both "Y" and "C" wire are present, tape off "C" wire.

These diagrams below are provided for new installations or unreferenced wires.

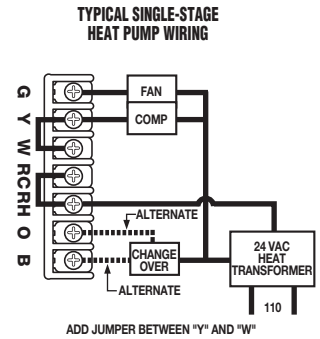
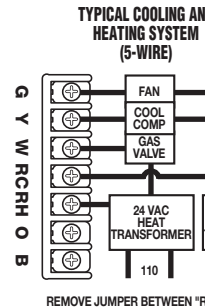
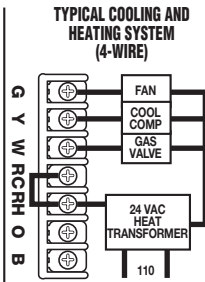
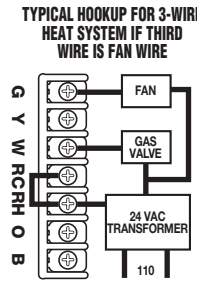
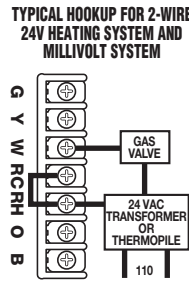

NOTE
If you have an electric system and the blower does not operate after installation, find the electric/gas heat jumper on the back of the body. Move the jumper to the ELEC position.

INSTALLING BATTERIES/ MAINTENANCE

The TX250 requires batteries to operate your furnace and retain its programming in memory. Replace the batteries when the REPLACE indicator appears in the display or at least once a year.

REPLACE BATTERIES WHEN INDICATOR APPEARS OR AT LEAST ONCE A YEAR.

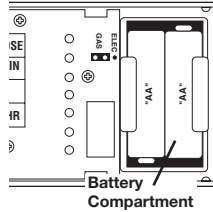

1. Remove fresh batteries from their carton.
2. Cup and hold thermostat body and left tab in place with left hand. Separate tabs with right hand.
3. Remove the used batteries.
4. Install two new Energizer® or DURACELL® "AA" size alkaline batteries in the battery compartment. Observe the polarity marking shown in the compartment. Place body back on wall.

WARNING: Use Energizer® or DURACELL® Alkaline Batteries Only.

NOTE
When replacing batteries, you have approximately 1 minute before programs are lost.

5. Align the top of the body onto the base and press together.

Installation is now complete. Be sure to turn the power back on to your heating and/or air conditioning system. If this is the first time you are installing batteries, the thermostat will display "SUN 12:00 AM". Within 90 seconds the thermostat will begin to display the room temperature alternately with the time. To correct the display, see "Setting the TIME and DAY," after you set the programs.

PROGRAMMING CHART

DAY	PERIOD	HEAT		COOL	
		TIME	TEMP.	TIME	TEMP.
MON. THRU FRI.	MORN				
	DAY				
	EVE				
SAT. and SUN.	NIGHT				
	MORN				
	DAY				
	EVE				
	NIGHT				

OPERATION

This thermostat is "armchair programmable" You can make any program or setting changes with the thermostat body off or on the wall thermostat base.

The TX250 alternately displays the current time and the room temperature. It also displays the day of the week and the currently active program period that is controlling the temperature: MORN, DAY, EVE, or NITE.

The set point temperature will appear in the right side of the display. In the winter, set the system switch to HEAT to control your heating system. In the summer, set the switch to COOL to control your air conditioner. In spring and fall or when windows are open, you can set the system switch OFF.

Setting the FAN switch to AUTO automatically runs your system's fan during heating and cooling. Setting the FAN switch to ON runs your system's fan continuously even without heating or cooling.

N O T E
The FAN switch works only if your system provides a wire for the TX250's "G" terminal.

THE BUILT-IN ENERGY STAR® PROGRAMS

Push in the RESET key. This sets the default heating and cooling programs. To review the default programs, move the Speed Slide to SET WEEKDAY or SET WEEKEND.

You can use the default programs as shown, or change them as you wish. Each day is divided into four periods. Each period has its own starting time and temperature.

	PERIOD	HEAT	COOL
WEEKDAYS preprograms	MORN	6:00 AM 70°	6:00 AM 78°
	DAY	8:00 AM 62°	8:00 AM 85°
	EVE	6:00 PM 70°	6:00 PM 78°
	NIGHT	10:00 PM 62°	10:00 PM 82°
WEEKEND preprograms	MORN	6:00 AM 70°	6:00 AM 78°
	DAY	8:00 AM 62°	8:00 AM 85°
	EVE	6:00 PM 70°	6:00 PM 78°
	NIGHT	10:00 PM 62°	10:00 PM 82°

PROGRAMMING THE TX250

You can change any preset times and/or temperatures to suit your schedules for the weekday and weekend programs. Each period (Morning, Day, Evening, and Night) is programmed for HEAT and for COOL.



Select HEAT to program the TX250 for controlling your heater. OR Select COOL to program the TX250 for controlling your air conditioner.

Slide the Speed Slide to SET WEEKDAY PROGRAM. To program the weekends SET WEEKEND. With Slide on SET WEEKDAY PROGRAM, you will see the display above.

UP	DOWN	To change the start time for MORN.	UP	DOWN	To change the start time for EVE.
NEXT		To program temperature.	NEXT		To program temperature.
UP	DOWN	To change the temp. setting for MORN.	UP	DOWN	To change the temp. setting for EVE.
NEXT		To move to DAY.	NEXT		To move to NIGHT.
UP	DOWN	To change start time for DAY.	UP	DOWN	To change the start time for NIGHT.
NEXT		To program temperature.	NEXT		To program temperature.
UP	DOWN	To change the temp. setting for DAY.	UP	DOWN	To change the temp. setting for NIGHT.
NEXT		To move to EVE.			Move Speed Slide to RUN position to start the programs.

SETTING THE TIME AND DAY

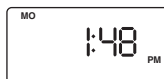

C A U T I O N
The TX250 is protected against normal static electric discharges. However, in extremely dry weather you should touch another metal object before the TX250 to avoid potential loss of programs.

Move the Speed Slide to SET DAY/TIME position. You should see the display pictured above with a day of the week flashing. When you are finished setting the day and time, rotate the dial to RUN to return to normal operation or to another position to continue programming.

UP	NEXT	To change current day. To set current time. The (e.g. "12:00") will be flashing.	UP	DOWN	To change the current time.
----	------	--	----	------	-----------------------------

TEMPERATURE OVERRIDE AND TEMPERATURE HOLD

These features let you change the current Set Temperature without changing the programs stored in your thermostat's memory.

TEMPORARY TEMPERATURE OVERRIDE



- Press UP/DOWN to change the current temperature setting. The OVERRIDE indicator appears on display.
- The OVERRIDE feature will be automatically canceled at the start of the next program period.
- To cancel OVERRIDE prior to next program period press UP/DOWN until original set temperature appears. OVERRIDE indicator will disappear from display.

TEMPERATURE HOLD



- Press HOLD. Adjust temperature as desired with UP/DOWN.
- Temperature setting will not change even after next program period begins.
- To clear, press HOLD again.

ADVANCED FEATURES

TEMPERATURE SWING

A thermostat works by turning your heating or cooling system on and off whenever the room temperature varies a certain number of degrees from the set-point temperature. This variation is the "swing."

Your system should cycle on about 3 to 6 times per hour. A smaller swing number increases the number of cycles, so room temperature is more constant. Setting "1" is approximately 1/4°F. Each increase of 1 value increases the swing by approximately 1/4°F. A larger swing number decreases the number of cycles, and may save energy in some cases.

SWING SETTINGS



Speed Slide must be in the run position

HOLD	NEXT	Press together
UP	DOWN	To change swing
NEXT		Press to set.

W A R N I N G

Making these changes will require you to reset the thermostat. Copy any of your customized programs onto the blank chart. This will be your reference to re-enter the programs afterwards.

CHANGING FROM °F TO °C AND A 12HR CLOCK TO A 24HR CLOCK

- WARNING:** Making these changes will require you to reset the thermostat. Copy any of your customized programs onto the chart below. This will be your reference to reenter the programs afterwards.
- Located to the left of the circuit board are three black jumpers C/F and 24/12H.
- To change to Celsius - remove jumper - JP2.
- To change to a 24HR clock - remove jumper JP1.
- Press the reset key on the front of the thermostat for changes to take effect.
- Reprogram as necessary.

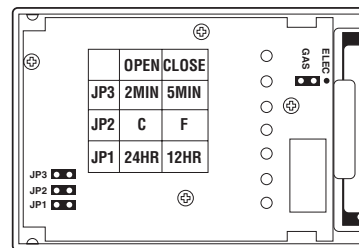

5 MIN/2 MIN MINIMUM ON/OFF TIME

Your thermostat has an internal timer built in to protect your compressor. The timer forces a minimum on/off time of 5 minutes. You may change this minimum on/off time to 2 minutes. To accomplish this, remove the jumper labeled JP3. You must press the small reset button on the face of the thermostat for the changes to take effect.

TECHNICAL SERVICE

If you have any problems installing or using this thermostat, please reread the instructions carefully. Technical Service is available through our Technical Service Number. If you require assistance, please call our offices between 8:00 a.m. and 4:30 p.m. Eastern Standard Time, Monday through Friday. The number is (856) 234-8803 or visit our online technical support at www.luxproducts.com.

WARRANTY

Limited Warranty: If this unit fails because of defects in materials or workmanship within one year of date of original purchase, LUX will, at its option, repair or replace it. This warranty does not cover damage by accident, misuse, or failure to follow installation instructions. Implied warranties are limited in duration to one year from date of original purchase. Some states do not allow limitations on how long an implied warranty lasts, so the above limitation may not apply to you. Please return malfunctioning or defective units to the participating retailer from which purchase was made, along with proof of purchase. Please refer to Technical Service Section before returning thermostat.

Purchaser assumes all risks and liability for incidental and consequential damage resulting from installation and use of this unit. Some states do not allow the exclusion of incidental or consequential damages, so the above exclusion may not apply to you. This warranty gives you specific legal rights and you may also have other rights which vary from state to state. Applicable in the U.S.A. only.

Free Manuals Download Website

<http://myh66.com>

<http://usermanuals.us>

<http://www.somanuals.com>

<http://www.4manuals.cc>

<http://www.manual-lib.com>

<http://www.404manual.com>

<http://www.luxmanual.com>

<http://aubethermostatmanual.com>

Golf course search by state

<http://golfingnear.com>

Email search by domain

<http://emailbydomain.com>

Auto manuals search

<http://auto.somanuals.com>

TV manuals search

<http://tv.somanuals.com>