

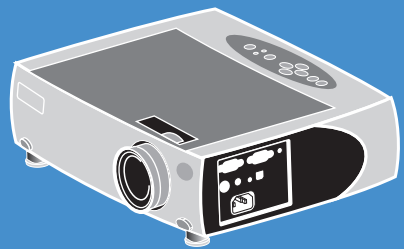

LUXEON

USER'S GUIDE



X2 *plus*

XGA Digital LCD Projector

Specifications

Specification	AV-X2 Plus
Weight in lbs. (kg)	7.2 (3.26)
Dimensions (inches) (WxDxH)	12.8 x 9.8 x 3.6 (with lens)
Dimensions (mm) (WxDxH)	325 x 250 x 92 (with lens)
Color Palette	16.7 million (24 bit)
Resolution	1024 x 768 (native)
SXGA compression(1024 x 768)	Yes
Three 0.9" panel polysilicone LCD	Yes
Projection lamp	130W, ultra compact
User-replaceable lamp	Yes
Brightness (ANSI lumens - based on industry specification practices)	1600 Lumen
Contrast ratio	400:1
Projection Lens	Manual zoom / focus
Aspect Ratio	4:3, 16:9
Audio (built in)	mono, 1 x 3 watts
Digital Keystone	+/- 15°
Video Compatibility – NTSC/NTSC 4.43 PAL B/D/G/H/I/K/L/N/M SECAM B/D/G/H/K/L	Yes
Computer compatibility	VGA/ SVGA/ XGA/ SXGA
Vertical frequency (Hz)	56 – 85
Horizontal frequency(KHz)	30 – 90
MACINTOSH Compatibility	Yes
Audible noise – typical	< 36 dB (at 25° C)
Connections on projector	
Analog RGB (15 Pin HD)	in x 1, out x 1
Composite video (RCA)	Yes (x1)
Stereo Audio (1/8" mini-plug)	Yes (x2)
S-video	Yes (x1)
USB	Yes (x1)
Power Supply	
Voltage (AC RMS)	100-240
Frequency (Hz)	50/60
Typical Power Consumption (watts)	195
Operating Temperature Range	0-35° C
Storage Temperature Range]	-20-70° C
Humidity Range (relative)	10-95%
Altitude (operating)	0 - 10,000 ft 0 - 3,048 m
Altitude (storage)	0 - 40,000 ft 0 - 12,192 m

LCD Projector

User Guide

FCC Warning

This equipment has been tested and found to comply with the limits for a Class A digital device, pursuant to part 15 of the FCC rules. These limits are designed to provide reasonable protection against harmful interference when the equipment is operated in a commercial environment. This equipment generates, uses and can radiate radio frequency energy and, if not installed and used in accordance with the instruction manual, may cause harmful interference to radio communications.

Operation of this equipment in a residential area is likely to cause harmful interference in which case the user will be required to correct the interference at his own expense.

Canada

This class A digital apparatus complies with Canadian ICES-003.

Cet appareil numérique de la classe A est conforme à la norme NMB-003 du Canada.

Safety Certifications

UL, CUL, TUV

EN 55022 Warning

This is a Class A product. In a domestic environment it may cause radio interference, in which case the user may be required to take adequate measures. The typical use is in a conference room, meeting room or auditorium.

Declaration of Conformity

We declare under our sole responsibility that the Zoom Digital Projector conform to the following directives and norms:

Directive 89/336/EEC, Amended by 93/68/EEC

EMI: EN 55022 (1992) Class A

EMC: EN 50082-1 (1992)

IEC 801-2, IEC 801-3, IEC 801-4

Directive 73/23/EEC, Amended by 93/68/EEC

Safety: EN 60950: 1992 + A1 + A2 + A3: 1995

Taiwan BSMI

Table of Contents

Introduction	4
What's in the Box	4
Projector Features	5
Remote Instruction	5
How to use Remote	6
Remote mouse function	6
OSD Menu Funicton	6
Connecting the Projector.....	7
S-Video to S-Video Cable	7
D-SUB 15 pin RGB Cable	7
RCA Video Cable	7
USB Cable	7
Mini-Stereo to Mini-stereo Audio Cable	7
Mini-Stereo to RCA Stereo Cable	7
Starting the Presentation	8
Power button	8
Turning Off the Projector	9
Keystone correction	10
Volume	10
Brightness	10
Contrast	10
OSD Menu Format and Description.....	10
Basic Menu	10
Picture Menu at PC Mode	10
Horizontal position (Data only)	11
Vertical position (Data only)	11
Tracking (Data only)	11
Frequency (Data only)	11
Picture Menu at Video Mode	11
Tint (Hue) (NTSC Video only)	11
Color (Saturation) (Video only)	11
Video AGC (Video only)	11

Video Type (Video only)	11
Digital Zoom & Pan	12
Format	12
Projection Type	12
Language	12
Utilities - 2 Menu	12
Utilities - 1 Menu	12
Reset All	13
Auto Image	13
Color Management	13
OSD Position	13
Auto Source	13
Status at PC Mode	14
Status at Video mode	14
Lamp Hours Reset	15
Input source select	15
Auto Image In Progress	16
Lamp Off Control	16
Out of Range	16
Positioning the Projector	17
Preset Timing	18
Maintenance	19
Change the Lamp Module	19
Cleaning the Projection Lens	20
Cleaning the Exterior Case	20
Cleaning the Air Filter	21
Troubleshooting	22
Power Indicator	22
Image Quality	23
Sound	24
Remote Control	25
Lamp	25
Safety	27
Safety Definitions	27
Projector Safety	27
Battery Safety	28

Introduction

The easy-to-use LCD Digital Projector offers superb image quality at an affordable price. Built into the LCD Digital Projector with Image Manager feature. With this feature, you can select the image display setting best suited for your specific presentation material and projection environment.

In only minutes you can have your LCD Digital Projector ready to go. Just connect the projector to an image source such as a computer, DVD, VCR, or digital camera.

If you are familiar with connecting and using digital projectors, refer to the **Quick Start Guide** included with the projector. If not, follow the directions in this user guide to connect your projector and run your presentation.

What's in the Box

Make sure that all of the following components were included with the projector. Contact your dealer immediately if anything is missing.

- Soft carry case
- Lens cap
- Analog RGB (15 Pin HD) cable
- S-video cable
- Composite video cable
- Stereo audio cable – 1/8" mini-plug
- RCA audio cable to 1/8" mini plug
- USB cable
- Power cord
- User Manual
- Quick Start Guide
- Remote control
- MACINTOSH adapter

Projector Features

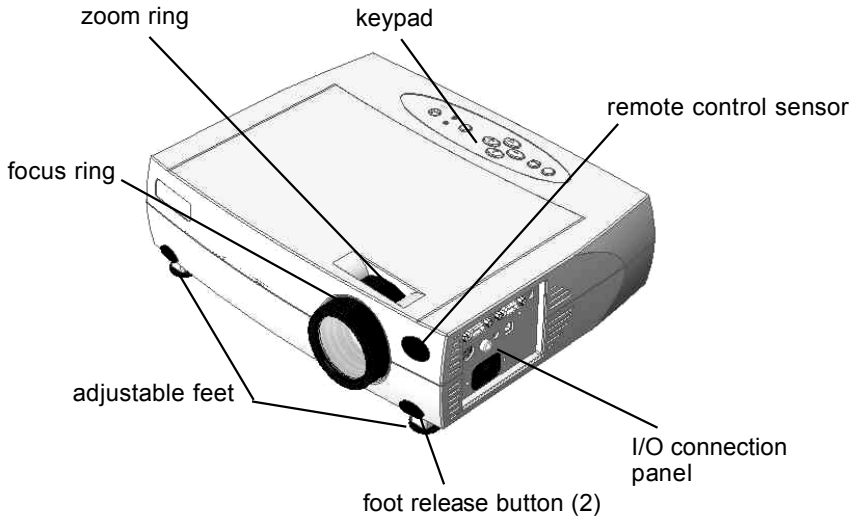

Remote Instruction

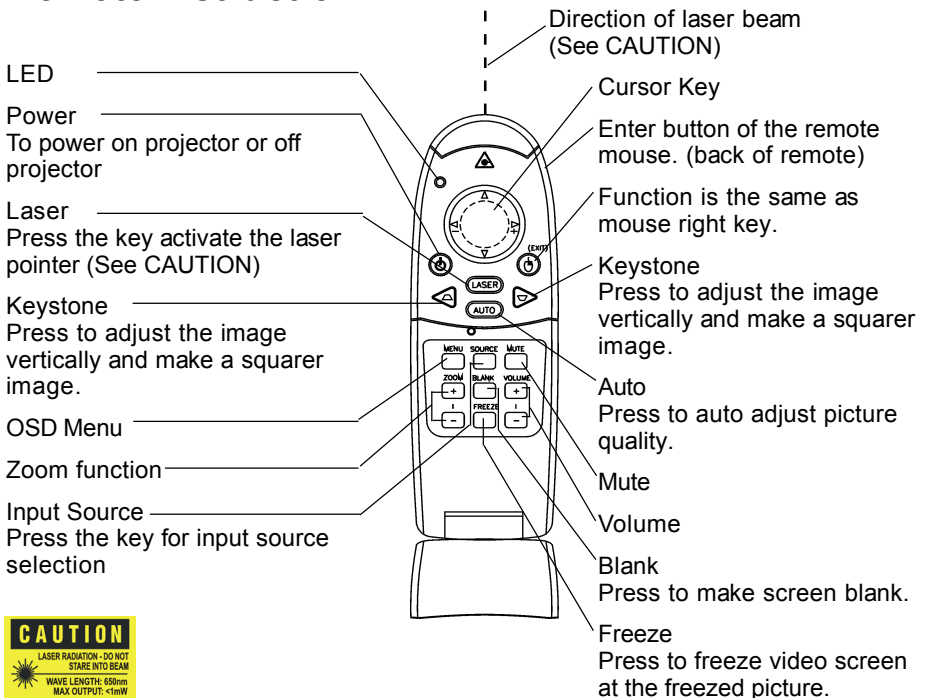

How to use Remote

Install AAA battery x2 into the remote.

Remote mouse function

The flip cover must be closed in order for the mouse function to work.

OSD Menu Function

- The flip cover must be open.
- Press "Menu" to enter OSD menu.
- Up/down arrow of the cursor key will be same as ▲ / ▼ showed in the OSD menu.
- Left / right arrow of the cursor key will be same as - / + function.
- Exit is same as ↵ to exit OSD menu.

Using the Laser Pointer

The LASER button on the Remote activates a laser which emits a red laser beam from the front of the Remote unit. It is typically used as a pointer during presentations. The laser beam emits for the duration that you press the button.

Caution

- Do not stare into laser beam for it can cause harm to your eyes.
- Do not aim the laser at people and procedures other than those specified therein may result in hazardous radiation exposure.
- If the Remote transmitter malfunctions or causes a malfunction, consult with a qualified Luxeon Personnel.



This label is located on the back of the Remote unit

Connecting the Projector

The cable are color coded to assist you with making the connections. When you connect the power cable to the projector, the Power LED on the keypad will be turned on.

You can connect more than one image source at a time as above reference drawing. Image source can be either automatically selected or you can switch off "AUTO SOURCE" function of OSD MENU to be manual selection. Manual selection is operated by pressing "INPUT" key.

If you are using an older MACINTOSH computer, you might need to use the MACINTOSH adapter that was included with your projector.

Warning: Always turn off the image source (computer or video source) and projector before connecting or disconnecting cables.

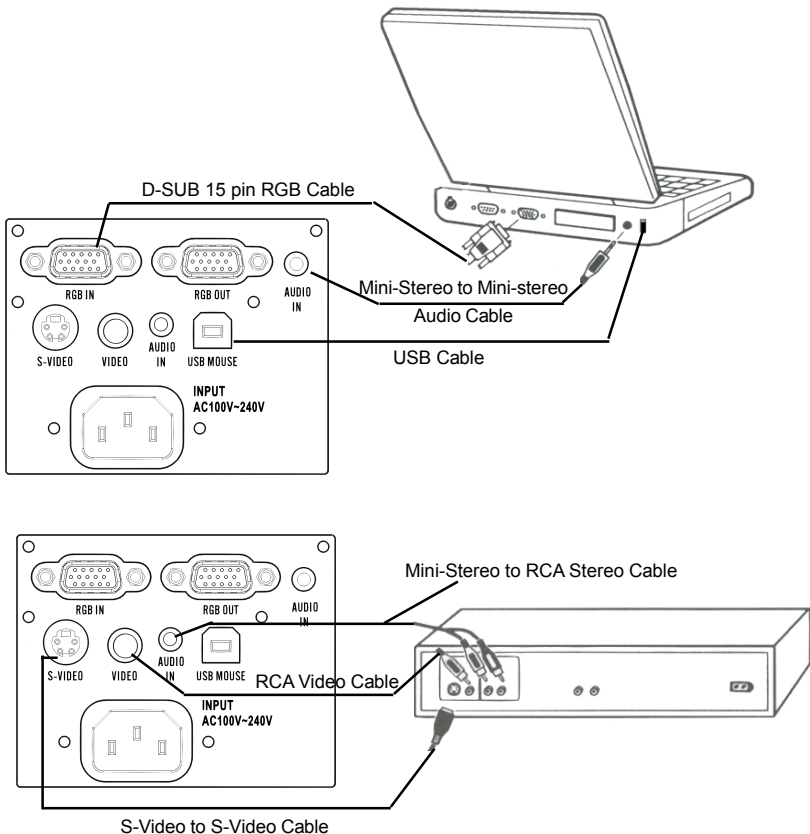

Starting the Presentation

We recommend turning on the projector and image sources in the order listed here.

1. Connect the signal cable to the computer or video source.
2. Connect the power cord to the projector and to a power source. The Power light begins to blink.
3. Turn on the presentation components in the order listed. To turn on the projector, remove the lens cap and press the Power button on either the remote control or the keypad, when lamp ready LED is on.

Note: You might not be using all of these components for your presentation.

- Video source such as VCR, VCD, DVD or digital camera.
- Audio source if different from your video source or computer
- Projector
- Computer

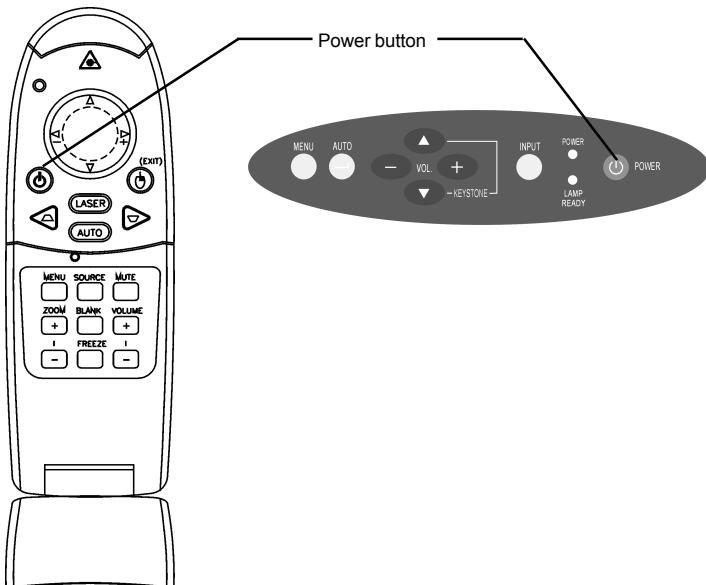

Note : Many laptop computers do not automatically turn on their external video port when another display device is connected. Refer to your computer's user guide for the function key or command that activates the port. MAC users may need to turn on SimulSCAN or monitor mirroring. Refer to the computer manual.

4. Position the projector by using the adjustable feet on the bottom of the projector. Press the foot release buttons in the front of the projector to raise or lower the feet.

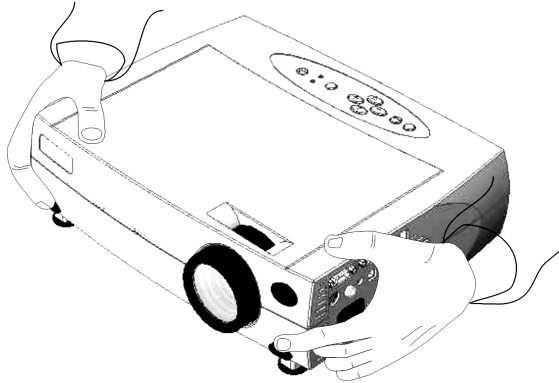

5. Turn the focus ring to focus the image and turn the zoom ring to zoom in or out on the image.
6. Make any necessary image adjustments by using the on-screen menus.

Turning Off the Projector

Turn off the projector and image sources in the order listed here.

To turn off the projector:

1. Press the Power button on the keypad or remote control.
A confirmation screen appears.
2. Press the Power button again to confirm.
The lamp turns off immediately but the fan continues to run until the projector cools down around 60 seconds.

Note: You might not be using all of these components for your presentation.

- Computer
- Projector
- Audio source if different from your video source or computer
- Video source such as VCR, DVD or digital camera.

OSD Menu Format and Description

Basic Menu

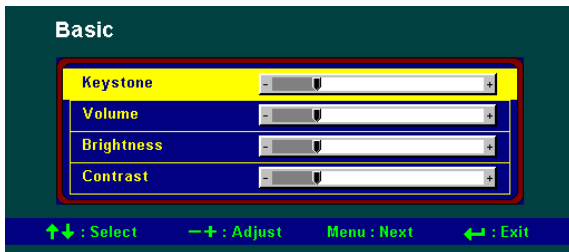

Description :

Use the up and down keys to select function item.

Use the - and + keys to adjust value.

Hit ↵ to exit.

Keystone correction

Description: Use the - and + keys to adjust the keystone level of display.

Volume

Description: Use the - and + keys to adjust the volume level.

Brightness

Description: Use the - and + keys to adjust the display brightness.

Contrast

Description: Use the - and + keys to adjust the display contrast.

Picture Menu at PC Mode

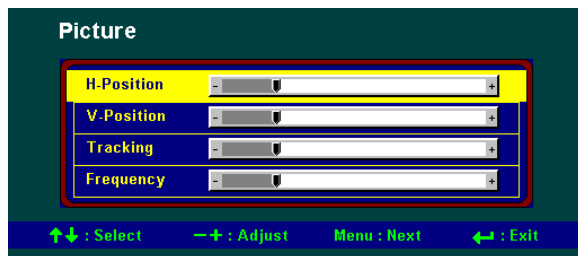

Description :

Use the up and down keys to select item.

Use the - and + keys to adjust value.

Hit ↵ to exit.

Horizontal position (Data only)

Description: Use the - and + keys to adjust the display position in horizontal direction

Vertical position (Data only)

Description: Use the - and + keys to adjust the display position in vertical direction

Tracking (Data only)

Description: Use the - and + keys to adjust the sampling number

Frequency (Data only)

Description: Use the - and + keys to adjust the sampling clock

Picture Menu at Video Mode

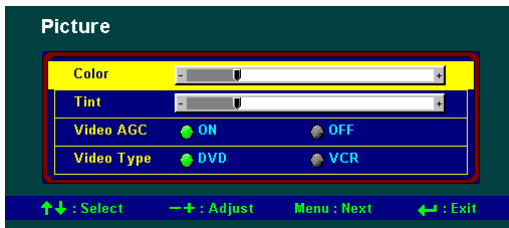

Description : Use the up and down keys to select item.
Use the - and + keys to adjust value.
Hit ↵ to exit.

Tint (Hue) (NTSC Video only)

Description: Use the - and + keys to adjust the video tint/hue.

Color (Saturation) (Video only)

Description: Use the - and + keys to adjust the video saturation.

Video AGC (Video only)

Description: Use the - and + keys to adjust the video automatic gain control.

Video Type (Video only)

Description: Use the - and + keys to adjust the video source type

DVD mode: Best quality mode.

VTR mode: Enable the video tape player mode for best compatibility.

Utilities - 1 Menu

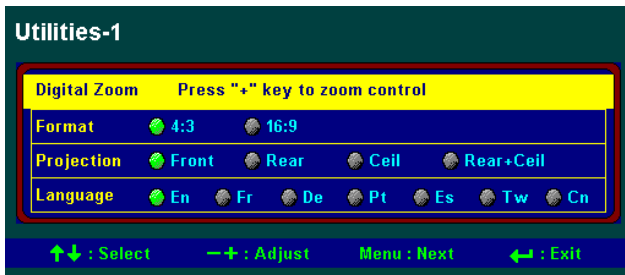

Description :

Use the up and down keys to select item.

Use the - and + keys to adjust value.

Hit ↵ to exit.

Digital Zoom & Pan

Description : Press + to enter zoom mode.

Zoom: Use “+” key to zoom.

Pan: 1. Press “Menu” to enter panning.

2. Press “+” to pan to right; “-” pan to right

3. Press ▲ to pan upward; ▼ to pan downward.

Format

Description : Use the -and + keys to adjust the video aspect ratio.

Projection Type

Description : Press – and + to select different projection type.

Language

Description : Press + to select language.

Utilities - 2 Menu

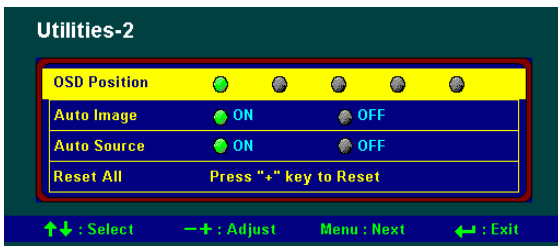

OSD Position

Description: Showing the OSD position .

Use the - and + keys to adjust OSD position.

On top-left, top-right, center, bottom-left, bottom-right

Hit ↵ to exit.

Auto Image

Description : Press + key to adjust “Auto Image” setting.

ON: Enable image automatically fine tuning.

OFF: Disable image automatically fine tuning.

Auto Source

Description: Automatically search the input source.

Reset All

Description : PC mode: Press + to reset all adjustable PC setting.

Video mode: Press + to reset all adjustable Video setting.

Color Management

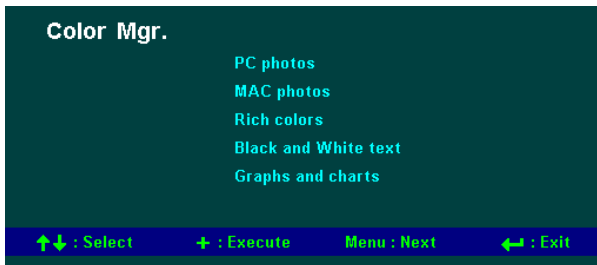

Description: Press up and down key to select different gamma correction

Press + key to execute

PC photos: Best for viewing PC photo.

MAC photos: Best for viewing MAC photo.

Rich colors: Best for colorful graphics.

B&W: Best for B&W text and spreadsheet presentation.

Graphic: Best for graphic presentation.

Status at PC Mode

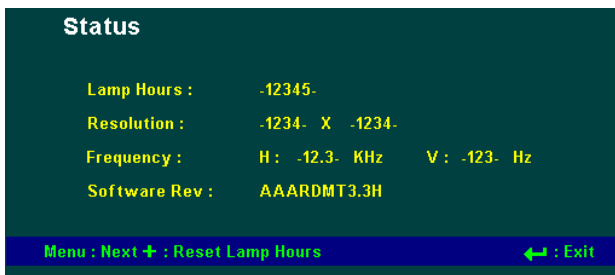

Description:

Showing the input signal status and the detected PC mode with model number and firmware version information.

Use + key to reset lamp hours to zero.

Hit ↵ to exit.

Status at Video mode

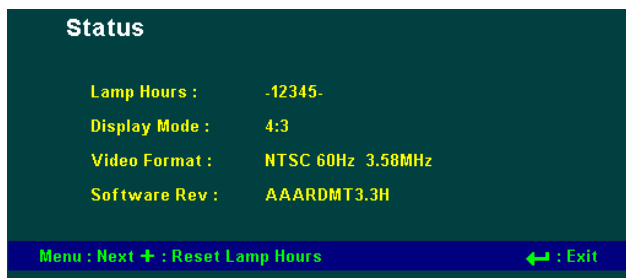

Description:

Showing the input signal status and the detected Video standard with aspect ration and firmware version information.

Use + key to reset lamp hours to zero.

Hit ↵ to exit.

Lamp Hours Reset

**Description:**

Use the - to confirm lamp hours reset.

Hit ↵ to exit.

Input source select

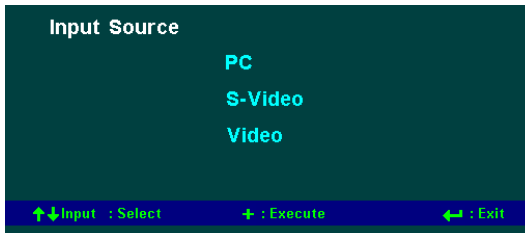
**Description:**

Press up , down and INPUT keys to select different input source.

Press + key to execute.

PC: Select PC / MAC input port.

S-Video: Select the S-Video input port.

Video: Select the Composite video input port.

Auto Image In Progress



Description: Message for auto image in progress

Lamp Off Control



Press the <Power> key again to turn lamp off, otherwise this screen will disappear automatically in 10 seconds.

Out of Range



Description: Message for input signal out of range.

Positioning the Projector

The projector should be at least 2.5 feet (.9 m) from the screen but no more than 32 feet (10 m) away from the screen.

Screen sizes are:

Distance	Width x Height	Diagonal
5' (1.5 m)	23~ 30"x 17~ 23" (0.58~0.76 x0.43~0.58 m)	28.6~37.9" (0.7~1.0 m)
6.5' (2.0 m)	30~ 40"x 23~ 30" (0.76~1.02 x0.58~0.76 m)	38.1~50.5" (1.0~1.3 m)
8' (2.4 m)	37~ 48"x 27~ 36" (0.94~1.22 x0.69~0.91 m)	45.8~60.6" (1.2~1.5 m)
9' (2.8 m)	43~ 57"x 32~ 42" (1.09~1.45 x0.81~1.07 m)	53.4~70.7" (1.4~1.8 m)
10.5' (3.2 m)	49~ 65"x 37~ 48" (1.24~1.65 x0.94~1.22 m)	61.0~80.8" (1.5~2.1m)
12' (3.6 m)	55~ 73"x 41~ 55" (1.40~1.85 x1.04~1.40 m)	68.6~90.9" (1.7~2.3 m)
13' (4.0 m)	61~ 81"x 46~ 61" (1.55~2.06 x1.17~1.55 m)	76.3~101.0" (1.9~2.6 m)
14.5' (4.4 m)	67~ 89"x 50~ 67" (1.70~2.26 x1.27~1.70 m)	83.9~111.1" (2.1~2.8 m)
16' (4.8 m)	73~ 97"x 55~ 73" (1.85~2.46 x1.40~1.85 m)	91.5~121.2" (2.3~3.1 m)
17' (5.2 m)	79~105"x 59~ 79" (2.01~2.67 x1.50~2.01 m)	99.1~131.3" (2.5~3.3 m)
18' (5.6 m)	85~113"x 64~ 85" (2.16~ 2.87 x1.63~2.16 m)	106.8~141.4" (2.7~3.6 m)
20' (6.0 m)	92~121"x 69~121" (2.34~3.07 x1.75~2.34 m)	114.4~151.5" (2.9~3.8 m)
33' (10 m)	153~202"x114~151" (3.89~5.13 x2.90~3.84 m)	190.7~252.4" (4.8~6.4 m)

Preset Timing

Mode Name(s) Used	Resolution	H. Frequency (KHZ)	V. Frequency (HZ)
VESA Standard	640 x 350	+ 37.86	- 85.08
VGA Compatibility	640 x 480	- 31.47	- 59.94
VESA Standard	640 x 480	- 37.86	- 72.81
VESA Standard	640 x 480	-37.50	-75.00
VESA Standard	640 x 480	- 43.27	- 85.01
MAC Compatibility	640 x 480	35.0	66.667
VESA Standard	720 x 400	- 31.47	+ 70.08
VESA Standard	720 x 400	- 37.93	+ 85.04
VESA Standard	800 x 600	+ 37.88	+ 60.32
VESA Standard	800 x 600	+ 48.08	+ 72.19
VESA Standard	800 x 600	+ 46.88	+ 75.00
VESA Standard	800 x 600	+ 53.67	+ 85.06
VESA Standard	1024 x 768	- 48.36	- 60.00
VESA Standard	1024 x 768	- 56.48	-70.07
VESA Standard	1024 x 768	60.02	75.03
VESA Standard	1024 x 768	+ 68.68	+ 85.00
MAC Compatibility	832 x 624	49.7	74.6
✦ VESA Standard	1280 x 1024	+ 63.98	+ 60.02
✦ VESA Standard	1280 x 1024	+ 79.98	+ 75.02
NTSC TV Mode	700 x 525	15.75	60.0
PAL TV Mode	700 x 625	15.60	50.0
HDTV 720p (RGB only)	1280 x 720	45.00	60.00

Remarks: ✦ only for XGA model

Maintenance

Change the Lamp Module

Important: The lamp contains trace amount of mercury. Some government required special disposal of lamps containing mercury. Dispose of lamps in accordance with the law and any applicable local regulations.

The lamp module should be replaced with a certified replacement part. To order a new lamp, contact your local dealer.

After change the lamp module, see “Lamp Hours Reset” on page 15 to reset lamp hours.

Warning:

1. When replacing the lamp, be sure to turn off power and unplug the power cord. To avoid burns, wait 45 minutes before opening the lamp module door and do not touch any hot surface inside.
2. Do not loosen or remove any screw other than lamp module or its door. Doing so may cause electric shock.

To replace the lamp module:

1. Turn off the projector and let the unit cool down at least 45 minutes.
2. Unplug the power cord from projector.
3. Turn the projector upside down. Loosen the screw with a flat head screwdriver then lift up to remove the lamp module door and keep screw on the door carefully.

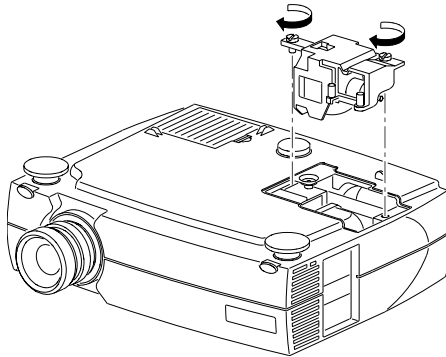

4. Loosen the two slotted screws on the lamp module bracket.
5. Gently lift and pull up on the metal wire to remove the lamp module.

Caution: Do not touch any glass portion of lamp module or may damage it and shorten its operation life. Do not drop the lamp module or glass may shatter to cause injury.

6. Carefully place the new lamp module into the projector with the glass portion facing left. Insert the lamp module securely and match two location pins to both location holes of the inner engine case. Tighten the slotted screws.
7. Place the lamp module door and tighten the screw.
8. See “Lamp Hours Reset” on page 15 to reset the lamp usage counter.

Important: Please make sure to replace lamp then reset the counter only.

Cleaning the Projection Lens

1. Turn off the projector and allow it to cool.
2. Remove the lens cap.
3. Apply a non-abrasive camera lens cleaner to a soft, dry cloth.

Caution: Avoid using an excessive amount of camera lens cleaner. Do not use abrasive cleaners, solvents or other harsh chemicals as they might scratch the lens. Do not spill any camera lens cleaner on the exterior case as it may fade, deform or melt the exterior case.

4. Lightly wipe the cleaning cloth over the lens.
5. If you do not intend to use the projector immediately, replace the lens cap.

Cleaning the Exterior Case

1. Turn off the projector and allow it to cool.
2. To remove dirt or dust, gently wipe the exterior case with a soft, dry, lint-free cloth.
3. To remove stubborn dirt or stains, moisten a soft cloth with water and a neutral detergent and gently wipe the exterior case.

Caution: Do not use alcohol, benzene, thinner or other chemical cleaners, which may fade, deform or melt the exterior case. Do not apply the detergent solution to the projector lens as it may scratch the lens.

Cleaning the Air Filter

To ensure proper ventilation of your projector, the air filter should be periodically cleaned. More frequent cleaning may be required if you use your projector in a dusty or dirty environment.

Caution: If the air filter is not cleaned properly, it can become clogged with dust and prevent proper ventilation. This may cause overheating and damage the projector.

Important: If the filter cannot be cleaned or becomes damaged or torn, it should be promptly replaced with a certified replacement part. Contact your local dealer of products for additional information.

1. Turn off the projector and wait for the fan stop.
2. Unplug the projector.
3. Turn the projector on its side so that the connection panel is facing upward.

Note: Standing the projector on its side keeps dust from getting inside.

4. Locate the air filter cover on the bottom of the projector and slide the cover latch downward to remove the cover.
5. Use a softbrush to clean the air filter being carefully not to tear the filter or loosen it.

Caution: Installing a wet or damp air filter may damage your projector.

6. Replace the air filter cover on the projector. Make sure that it clicks into place.

Caution: Never replace the air filter cover without the air filter attached; dust may get into projector without this filter. Never operate your projector without the air filter cover in place because this may damage your projector with dust.

Troubleshooting

Power Indicator

The power and lamp indicator on the keypad provides you with information about the condition of the projector.

Indicator	Light Status	Condition
Lamp LED	Blinking	Lamp is off but live power cord is connected to the projector. Projector is in standby mode. OR Lamp is off and fan is running. Projector is cooling down.
	Steady	Lamp is on and fan is running. Projector is ready.
Power LED	Two blinks	Scaling chip is malfunctioning.
	Three blinks	System is over temperature.
	Four blinks	I2C bus is malfunctioning.
	Five blinks	Lamp is malfunctioning.
	Six blinks	Fan is malfunctioning.
	Seven blinks	Top case was opened.

Image Quality

Problem	Solution
Color or text is not being projected.	Adjust the brightness up or down until the text is visible.
Some text or fonts are not sharp with a computer as an image source.	For optimal results, set the computer's resolution to 1024 x 768. (Refer to your computer user manual.) But this projector can compress resolutions up to 1280 x 1024.
Image isn't centered on the screen.	<ul style="list-style-type: none"> • Be sure that the projector is at a 90° angle to the screen. • Reposition the image.
Image is out of focus.	<ul style="list-style-type: none"> • Turn the projection lens to focus the image. • Make sure that the projection screen is at least 5 ft (1.5 m) from the projector. • Check the projection lens to see if it needs cleaning.
Image and menus are upside down.	<ul style="list-style-type: none"> • If projecting from a ceiling mount, make sure that Ceiling Projection is selected on the Setup tab in the Menu. • If projecting from an upright position, make sure that Front or Rear projection is selected on the Setup tab in the Menu.
Image and menus are reversed from left to right.	<ul style="list-style-type: none"> • If projecting from behind a screen make sure that Rear Projection is selected on the Setup tab in the Menu. • If projecting in front of a screen, make sure that Front or Ceiling Projection is selected on the Setup tab in the Menu.
Image appears flat with no contrast	<p>To adjust the contrast:</p> <ol style="list-style-type: none"> 1. Press Menu and use the Adjust + -buttons to go to the Adjust tab. 2. Use the Next button to highlight Contrast. 3. Use the Adjust + - buttons to increase or decrease the contrast.
Image appears washed out or dark	<ul style="list-style-type: none"> • Check the projection lens to see if it needs cleaning. • To adjust the brightness: <ol style="list-style-type: none"> 1. Press Menu and use the Adjust + - buttons to go to the Adjust tab. 2. Use the Next button to highlight Brightness. 3. Use the Adjust + - buttons to increase or decrease the brightness.

Problem	Solution
Image is “noisy” or streaked.	<ul style="list-style-type: none"> • From the Setup tab in the menus, adjust the frequency and tracking manually to find an optimal setting. • Try connecting to another computer. The problem could be with your computer’s video card.
Image is wider at the top or bottom of the screen.	This keystone effect is caused by the projection angle not being perpendicular to the screen. For a more pleasing image result, raise or lower the front legs or prop up the back of the projector, or adjust keystone function up ▲ or down ▼ .
Image is wider at one side than the other	Make sure the projector is at a 90 degree angle to the screen.
Projected colors don’t match the computer or video source colors.	<p>Use the Image Manager to select a setting that is more acceptable.</p> <p>Important: The Image Manager settings work best if you select Reset from the Adjust Tab each time before selecting an Image Manager setting.</p> <p>If further adjustment is needed, optimize the brightness, tint, color and contrast from the Adjust tab in the Menus.</p>

Sound

Problem	Cause and Solution
No sound.	<ul style="list-style-type: none"> • Adjust volume. • Verify audio / input connections. • Adjust audio source.
Poor sound quality.	<ul style="list-style-type: none"> • Make sure you are connected to the earphone jack on your laptop or line out jack on your desktop. • Make sure the volume setting on your computer is halfway.
No audio-out port on the image source.	You are not able to connect audio to the projector.

Remote Control

Problem	Cause and Solution
<p>Projector responds poorly or not at all to the remote control.</p>	<ul style="list-style-type: none"> • Make sure that the total distance from the remote to the projector is no more than 32 feet (10 m). • Point the remote control at the screen or at the front of the projector. • Make sure nothing is blocking the infrared sensor on the front of the projector. • Darken the room. The lighting might be affecting the remote control. • Replace the remote control batteries.

Lamp

Problem	Cause and Solution
<p>No light is coming from the lamp.</p>	<ul style="list-style-type: none"> • Make sure that the power cord is properly connected to a fully functional AC electric outlet. The Power light blinks when the power is connected but the projector is not turned on. The Power light is a steady green when the lamp is running. • Make sure that the power cord is properly connected to the projector. • Make sure that you have removed the lens cap on the projector lens at the front of the projector. • Make sure you have pressed the Power button and the Power light is a steady green. • Check the projector's lamp to make sure that it is securely connected in the lamp module. • Make sure that the lamp module door is fully closed. • Make sure that the cable connectors do not have any bent pins. • Replace the lamp.
<p>Lamp shuts off.</p>	<ul style="list-style-type: none"> • A minor power surge may cause the lamp to shut off. Press the Power button twice to turn off the projector. (The Power light continues to blink and the fan continues to run until the projector cools down.) Wait at least three minutes, then press the Power button again. • Replace the lamp module.

Image Source

Problem	Cause and Solution
The S-Video image source does not appear.	Some inexpensive cables are not compatible with the projector. Be sure to use the cable that came with your projector.
Only the start-up screen appears and not the image from the image source.	<ul style="list-style-type: none">• Verify that the cables are connected correctly. See “Connecting the Projector” on page 7.• Verify that the proper image source is connected and that it is selected on the Setup tab of the menus.• Make sure that the image source is turned on. • Turn off everything and power up again in the proper order. • Make sure that your laptop’s external video port is turned on. See the computer manual for details.
The image source is connected but a No Signal message appears.	<ul style="list-style-type: none">• Verify that the cables are connected correctly. See “Connecting the Projector” on page 7.• Verify that the proper image source is connected and that it is selected on the Setup tab of the menus.• Make sure there are no bent pins in the connectors.• Make sure the image source is turned on.• Turn off everything and power up again in the proper order. See “Starting the Presentation” on page 8.• Make sure that your laptop’s external video port is turned on. See the computer manual for details.

Safety

These safety precautions include information to prevent personal injury and damage to the projector.

Safety Definitions

Warning: Statements identify conditions or practices that could result in personal injury.

Caution: Statements identify conditions or practices that could result in damage to your equipment.



Warning: For information about use of a feature, please refer to this *User Guide*.



Warning: Hot surface. Do not touch.

Projector Safety



Warning: To replace the lamp, turn off the power and unplug the power cord. To avoid burns, wait 45 minutes before opening the lamp door. Follow all instructions provided in this *User Guide*. See “Changing the Lamp Module” on page 17.



Warning: When you open the lamp module door, be careful not to touch the hot surfaces inside.

Warning: Please use the power cord provided. Connect the power cord to a receptacle with a protective safety (earth) ground terminal.

Warning: Don't look directly into the lens when the lamp is on. Doing so may cause eye injury.

Warning: Servicing your own projector may expose you to hazards or create potential hazards. Also, servicing your own projector will void the warranty. Refer all service to qualified service personnel.

Warning: In the unlikely event of the bulb rupturing, thoroughly clean the area behind the projector and discard any food that might have been contaminated with broken glass.

Warning: Do not loosen or remove any screws other than those on the lamp module door and the lamp module. Doing so may result in electric shock.

Caution: Don't set liquids on the projector. Spilled liquids may damage your projector.

Caution: Don't put the projector on a hot surface or in direct sunlight.

Caution: Do not drop the projector.

Caution: Never operate your projector without the lamp module or lamp module door. Doing so may damage the projector.

Caution: Proper ventilation is important. Don't block ventilation openings. Never operate this projector in an enclosed area. Do not place the projector on a tablecloth or other soft covering that may block the vents. With ceiling installations, use approved mounting hardware. Do not put the projector near heat ducts, air cleaners, transformers or other electrical devices. For permanent installations follow local codes.

Caution: Do not touch the glass portion of the new lamp module with your hands or allow it to touch other objects as this may damage it and shorten its operational life.

Caution: Do not drop the lamp module as the glass may shatter.

Battery Safety

- Read and follow all warnings and instructions supplied by the battery manufacturer.
- Keep batteries away from children.
- Store batteries in their original packaging.
- When inserting batteries, verify that the (+) and (-) terminals are aligned correctly.
- Replace all batteries of a set at the same time.
- Do not mix new batteries with used ones.
- Do not use batteries of different chemistries, capacities, brands or sizes together. Leakage could result.
- Do not disassemble, recharge, or short-circuit batteries.
- Do not subject batteries to high temperature or fire.
- Discard used batteries according to all applicable local and national regulations.

Free Manuals Download Website

<http://myh66.com>

<http://usermanuals.us>

<http://www.somanuals.com>

<http://www.4manuals.cc>

<http://www.manual-lib.com>

<http://www.404manual.com>

<http://www.luxmanual.com>

<http://aubethermostatmanual.com>

Golf course search by state

<http://golfingnear.com>

Email search by domain

<http://emailbydomain.com>

Auto manuals search

<http://auto.somanuals.com>

TV manuals search

<http://tv.somanuals.com>