

Mace Security Products, Inc. Presents:

Digital Video Recorder based on Mpeg4 Technology

Operational Manual



**DVR0414
DVR56MR
DVR15MR**

Thanks for purchasing products of Mace Security International, Inc.

For your convenience in calling for service or technical support, please record the following important information:

Model: DVR0414, DVR56MR, DVR15MR (select one)

Hard Disk: 80G, or _____

Serial #:

Date Purchased:

Sales Person:

Company Name:

Phone:

Fax:

Consult Mace's website at <http://www.mace.com> for a complete line of surveillance and security products.

General Safety Precautions

This manual applies to Mace 4-channel non-realtime series Digital Video Recorders. There are three models in this series, DVR0414, DVR56MR, and DVR15MR. DVR0414 will be used in all illustrations.

- 1. Installation Environment**
- 2. Open Product Box and Verify Contents**
- 3. Before Power-up**

1. Installation Environment

- **An UPS (Uninterrupted Power Supply) with power surge protection is strongly recommended for DVRs and all associated devices (routers, DSL modems, etc)**
- Avoid extreme heat
- Avoid direct sunlight
- Avoid excessive humidity
- Maintain horizontal mounting
- Avoid excessive vibrations
- Do not stack other devices on top of the DVR
- Operate in well ventilated place, do not block the cooling fan

2. Open Product Box and Verify Contents

Check for the following accessories:

- One power cord
- One hard disc Ribbon Cable
- One operation manual
- One CD for utility software (normally it is not needed).
- One remote control unit
- Two AAA batteries

3. Before Power-up

- Make sure the orange tab is set to 110V at the back of the DVR power supply
- Be sure the UPS power supply is properly connected
- Be sure to plug power cord into a reliable 110 VAC power source

Table of Contents

General Safety Precautions	3	?
1. Installation Environment	4	?
2. Open Product Box and Verify Contents	4	
3. Before Power-up	4	?
Chapter 1: Product Specifications and Features	7	?
1. Product Specification	8	
2. Product Features	9	?
3. Storage Matrix	11	
Chapter 2: Basic System Operations	? 13	
1. Start/Stop the DVR	14	?
2. Recording	15	
3. Alarm Input/Output	16	?
4. Pan-Tilt Control	16	
5. Network Operation	16	?
Chapter 3: Front Panel Operations	17	
1. Front Panel Overview	18	?
2. Detail Key Function	19	
3. Enter/Leave the Operation Menu	21	
4. Maneuver in the Operation Menu	22	?
5. Menu Overview	23	
6. Operation Description	27	?
6.1 Recording Control	27	?
6.2 Playback	27	
6.3 Pan-Tilt and Zoom Camera Control	29	
6.4 Menu Detail	30	

Chapter 4: Operations over Network	37	
1. Setting Up the Client End	38	
2. Login and Logout	38	?
3. Operation of the Right Click Menu Items	40	?
4. Record Search and Playback	43	
5. System Configuration	45	?
6. Assistant	50	
Chapter 5: System Connections	55	
1. DVR Rear View	56	
2. RS-485 Port Connection	57	?
Appendix 1 Frequently Asked Questions	60	
Appendix 2 Hard Disk Installation	62	
LIMITED WARRANTY	63	?

Chapter 1 Product Specifications and Features

1. Product Specifications
2. Product Features
3. Storage Matrix

1. Product Specifications

Parameter	4 Channel
Processor	Trimedia PNX1302/200MH
Operation system	Real-time operation system (PSOS)
Model	DVR0414
Video input	4 Channel (NTSC/PAL) BNC (1.0V _{P.P.} 75 Ω)
Video output	1 Channel PAL/NTSC, BNC (1.0V _{P.P.} 75 Ω) video signal
Audio input	1 Channel 200-1000mv10K Ω (RCA)
Audio output	1 Channel 2000mv 1K Ω (RCA)
Video display	1,4 ,5 windows display
Video standard	NTSC (525 line, 60f/s), PAL (625 line, 50f/s)
System resource	Non real-time recording and simultaneous network operation, independent local playback
Image resolution	Real-time monitor 704×576, playback 352×288,
Motion detection	Area setting:192 detection areas on the screen; detection sense setting: 3 levels detection sense for each area
Video compression	MPEG-4 VBR (variable frame rate)
Audio compression	ADPCM
Image compression rate	352×288CIF format
Video recording speed	Total resources 25frames for PAL mode, 30 frames for NTSC mode
Image quality	6 levels selectable
Hard disk	One 40G hard disk preinstalled. Expandable to two large size hard disks.
HDD space used	Audio: 14.4Mbyte/hour Video: 60-460Mbyte/hour
Alarm input	4 channel voltage alarm input (+5~+15V D. C. Needed for the alarm input)
Alarm output	3 channels output, (output in open/close contact or controllable +12V output)
Alarm relay	30VDC 1A, 125VAC 0.5A (relay output)
Network connection	RJ45 10M/100M Ethernet connection
Pan-tilt control	RS485
Power	110±15%V 60±2% HZ
Power consumption	60W
Working temperature	-10℃ - +55℃
Working humidity	10% - 90%
Barometric pressure	86kpa - 106kpa
Size	200 (breadth)x275(depth)x130mm (height)
Weight	5.5KG

2. Product Features

- Real-time Monitor (Video Displays)
 - o 2 Video output ports to regular Analog Video Monitor
 - o Single window (Full Screen) /4 windows (Quad) /5 windows monitor display.
- Compression Method
 - o Multiple video compression modes: Variable frame.
 - o Single channel or 4 shared audio/video real-time recording or multi-channel non-real time audio/video recording.
- Storage
 - o Internally can hold 2 IDE-compatible large capacity Hard disk(HDD)
 - o Alternative HDD operations that will reduce the power consumption and heat emission.
 - o Overwrite (FIFO) and Stop (HDD Full) modes for DVR HDD recording.
- Back-up
 - o USB port for external back up of records.
 - o Download the files on DVR to local PC through network.
- Play and Record
 - o Supports multiplexed operation: live monitor, record, search for downloading, one channel play-back and remote transmission simultaneously.
 - o Multiple recording modes: Manual – Schedule – Alarm - Motion Detection. Note: Alarm Recording and Motion Recording have Pre-Alarm function.
 - o Playback: One window playback while live viewing all four channels. Playback also available using Network Connection.
 - o Fast search for reviewing manual recording and alarmed recording.
 - o Multiple play-back modes: fast forward, pause, X ?, X 1/3, X1/4 S slow play and frame by frame playback.
 - o Displays Time/Date during playback.

- Alarm relay
 - 4 channel external alarm input, video lost alarm and motion detection alarm.
 - Multi channel relay switch alarm output activates alarm relay and on-site light control.
 - Circuit Protection for Alarm inputs and outputs.

- Pan-tilt Control
 - Supports Camera Pan-Tilt-Zoom (PTZ) Functions using RS485 Communication Protocol.
 - Integrates multiple protocols to control various PTZ speed domes.

- Communication Connection Port
 - DB 15 (15 pin) connection for alarm inputs and PTZ control.
 - RS232 port for the connection with keyboard for central control and matrix control.
 - Standard Ethernet port for remote viewing and control.

- Network Operation
 - Remote real-time monitor.
 - Pan-tilt-zoom control.
 - Record search and real-time playback. Note: playback quality dependent on network conditions. Downloading records through network.
 - System programming, settings & modification and system software upgrades available online.
 - Remote alarm processing and system log review remotely.
 - Embedded TCP/IP protocol and RTOS (Real Time Operating System) supports Web server direct connection to operate and control all the above functions.
 - Administration mode: Three USER levels for logging in remotely. Each user login is password protected.

3. Storage Matrix

The HDD Capacities and Recording lengths are determined by capacity of the installed HDDs and the selected image level.

The following storage time is based on the average use for HDD space for single channel recording.

Coding	Image level	Resolution	Frames	Maximum data flux	Average HDD space (/hour)
CBR	1	352*288	30	128Kb/S	40MB
	2	352*288	30	256Kb/S	80MB
	3	352*288	30	384Kb/S	120MB
	4	352*288	30	512Kb/S	160MB
	5	352*288	30	768Kb/S	240MB
	6	352*288	30	1Mb/S	320MB

Note: DVR0414 supports 30 frames per second recording in total for the whole machine. Users may chose to record a single channel in real time (30 fps) or split the system resources evenly among several channels. Under the LIMITED mode, every one of the four cameras will be recording at a fix rate of 7.5 fps. Under the AUTO mode, depending on the number of channels that are recording, a channel can take 30, 15, 10 or 7.5 fps.

Following are storage calculation guidelines (in the number of Days):

	Image Quality	30F/S	Days
80G	1(128kb/s)	128kb/s	61
	2(256kb/s)	256kb/s	30
MP4(CBR)	3(384kb/s)	384kb/s	20*
	4(512kb/s)	512kb/s	15
	5(768kb/s)	768kb/s	10
	6(1024kb/s)	1024kb/s	8

* This reads that with an 80G harddisk, at CBR (constant bit rate) 30 fps and Image Quality 3, DVR will be able to record 20 days.

	Image Quality	15F/S	Days	10F/S	Days	7.5F/S	Days
80G	1	85kb/s	92	71kb/s	108	69kb/s	112
	2	144kb/s	56	109kb/s	72	92kb/s	84
MP4(VBR)	3	158kb/s	48	133kb/s	60	114kb/s	68
	4	227kb/s	36	175kb/s	44	159kb/s	48
	5	292kb/s	28	258kb/s	32	200kb/s	39
	6	557kb/s	16	443kb/s	18	333kb/s	24

Chapter 2 Basic System Operations

1. Start/Stop the DVR
2. Recording
3. Alarm Input/Output
4. Pan-tilt Control
5. Network

1. Start/close the recorder

1.1 Start the recorder

Plug in the power line; switch on the power button at the back of the recorder; power indicator light on; DVR on; default single window for the video output displays; press Enter the Log-in screen appears on Monitor; If the starting time is within the programmed recording time, the system will start recording function automatically. Channel indicator lights will indicate the cameras in record mode. The system will work in a normal manner.

Note: if the system stops during HDD Boot detection, the HDD may not be installed right and please check the HDD connections (Ribbon and Power Connections). ***Please unplug the 120VAC power supply during HDD installation***

1.2 Enter the setting menu

Before you enter the menu, you must input the password. There are two levels of password—User password and Administrator password.

Administrator password **555555** (Press the Jump to Next Section key ►► 6 times)

General user password **444444** ((Press the Fast Forwarder key ►► 6 times)

If input the user password, you have to input again at the next login; you are also not allowed to enter system setting and admin setting.

Note: For the consideration of security, please change the Administrator password in admin settings. Refer to Chapter 3 Front Panel Menu Operation for details.

1.3 Turning off the DVR

Press the POWER key on the front panel for 4 seconds to stop the current operations. Then switch off the power button at the DVR rear to turn off the power.

1.4 Power off recovery

When the power is cut off abnormally, the recorder will recall it's last state and continue where it left off. The state indicator light is the same as it was before the power off.

2. Recording

The default recording mode after startup of the DVR is 24 hr continuous recording for each channel. The User can program customized recording times for each camera. Instructions for the different recording modes are as follows:

a) Schedule Recording:

?Enter the menu, and set the timing period for the recording. See details at [Menu>System setting>Schedule](#)

b) Manual Record Selection

?Press “Record” button on the remote controller or “Rec” on the front panel.

?Check the status of each channel in the recording menu; The Highlighted channels are in record mode.

?To select the channel to be recorded, press the related number key. Selected camera # will highlight on your screen. When all cameras that need to be recorded are selected, press Enter to begin the recording.

?Repeat above steps and remove the highlight to stop the camera from recording. Press Cancel or ESC to return without changes.

c) Alarm recording

?Connect the alarm input according to the device connection and the instructions.

Program the related settings in the menu to start Alarm recording. See details at [Menu>System setting>Alarm setting](#)

d) Motion detection recording

?Record the channel only in need of motion detection. First confirm whether this channel is programmed in Timing Recording; if it is, please turn off Timing Recording for the selected Camera.

?Program the related settings in the menu to start Motion detection recording. See details at [Menu>System setting>Motion detection.](#)

3. Alarm connection operation

- ?Connect the alarm input according to the device connection and the instructions.
- ?Connect the related alarm output relay on the DVR to associated alarm device. Example: lights, beeper, etc.
- ?Program the associated information in the menu. See details at [Menu>System setting>Alarm setting](#)

4. Pan-tilt control operation

- ?Confirm the proper connection of the pan-tilt-zoom and Communication Protocol. Set the Camera address.
- ?Confirm the proper wiring connection between the PTZ and DVR's 15-pin port's A & B lines.
- ?Set up the programming. See details at [Menu>System setting>Pantilt Control](#)
- ?Select full screen call-up of associated P/T/Z Camera.
- ?Press "Fn" on the front panel to select
- ?Use direction arrow keys to move and control the selections on the screen

5. Network connection operation

- ?Confirm correct network connections between DVR and computer
- ?Set the IP address, subnet mask and gateway of the computer and DVR separately. If there is no router in the network, only the IP address is needed. If there are routers in the network, please enter the related gateway and subnet mask.
- ?Ping `***.***.***.***` the IP address of the DVR to check the link of the network. A successful reply shall look like (TTL value less than 64 ms is normal):

Reply from 68.153.205.130: bytes=32 time=31ms TTL=57
- ?Open IE browser and input the IP address of the DVR
- ?For Network operation see details at Chapter 4

Chapter 3 Front Panel Operations

1. Front Panel Overview
2. Detail Key Function
3. Enter/Leave the Operation Menu
4. Maneuver in the Operation Menu
5. Menu Overview
6. Operation Description
 - 6.1 Recording
 - 6.2 Playback
 - 6.3 Pan-Tilt and Zoom Camera Control
 - 6.4 Menu Detail

1. Front Panel Description

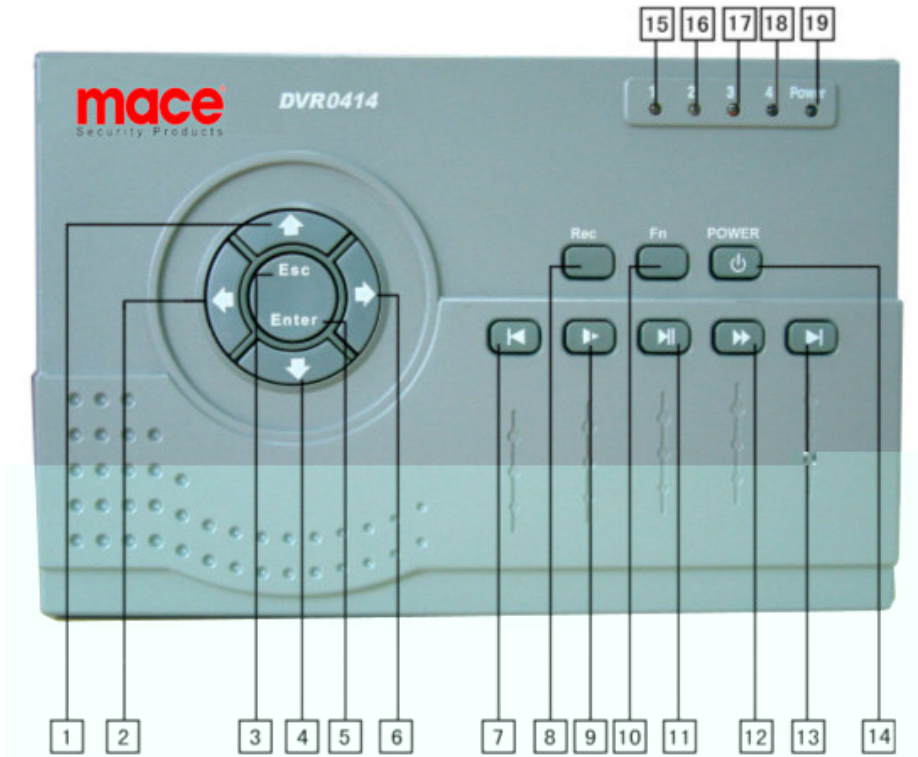

1. Up Direction (Ch 1)	2. Left Direction (Ch 3)	3. ESC (Cancel)	4. Down Direction (Ch 2)
5. Enter	6. Right Direction (Ch 4)	7. Play Last Section (#1)	8. Record
9. Slow Play (#2)	10. Function Key	11. Play/Pause (#3)	12. Fast Forward (#4)
13. Play Next Section (#5)	14. Power Switch	15. No.1 Recording Light	16. No. 2 Recording Light
17. No.3 Recording Light	18. No.4 Recording Light	19. Power Indicator	

Note: Outside Ring of the jog shuttle when turning clockwise is equal to right direction arrow, turning counterclockwise is equal to left direction arrow; inner circle turning clockwise equal to down direction, otherwise equal to up direction.

2. Keys functions

Order	Key name	Logo	Function	Remark
14, 19	Power switch and indication light	POWER	Power switch (Power off by pressing the key for 4 seconds)	
			Indication light	
15, 18 16, 17	Recording light	Red	If the light is red ,it means recording	
2, 6	Left and right	◀ ▶	Transverse moving, shifting level1and level2 menu; pan-tilt control shift, when monitoring audio/video, shift channel 3 and channel 4	
1, 4	Up and down	▼ ▲	Lengthways moving; change setup; change number; pan-tilt control; when monitoring audio/video,, shift channel 1 and channel 2	
3	Cancel	ESC	Cancel	
			During playback, restore to real-time monitor	
5	Enter	ENTER	Enter	
			Enter main menu	
10	Function assistant	Fn	Press the key to display the menu of the pan-tilt moving and camera lens control When setting Motion Detection areas, selection on/off key During playback, display the playback status bar	
8	REC	Rec	Manual start/stop recording, use the number key to toggle on/off. Shadowed numbers to start recording	REC ORD 1 2 3 4 A SELECT CHANNEL
			1,2,3,4 represent the recording on/off state of the corresponding channels. A stands for "ALL". Press Enter to activate.	

7	Play last section	⏮	Play the recording file before the current file	# 1
9	Slow play	▶	3 levels of slow play speed (?1/2、?1/5、?1/30)	# 2
11	Play/pause	/	Play/Pause	# 3
			When in monitor, press it to enter recording search menu	
12	Fast Forward	▶▶	Adjust to different Fast forward speeds	# 4
13	Play next section	▶▶▶	Play the recording file next to the current file	# 5

Note: (1) The four direction keys can be used to switch channels under the single camera view.
 (2) The five playback control keys represent numerical key 1 to 5 while changing the system configuration.

3. Operation Menu Overview

To enter the Operation Menu, press **Enter** key twice, the system will prompt for password.

Default Administrator password is “555555”. (Note: ► is the #5 key)

Default User password is “444444”. (Note: ► is the #4 key)







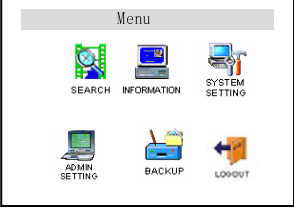
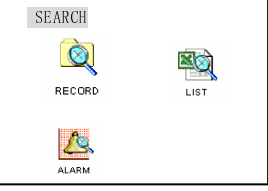
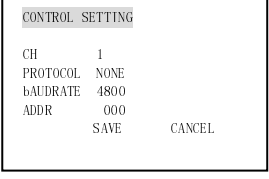
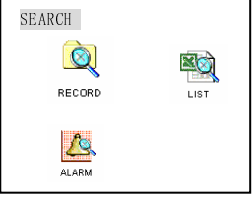

If not touched for 5 minutes, the system will automatically logout the currently user.

For security reason, the Administrator may choose to manually logout under Menu/ Logout





4. Maneuver in the Menu System









Operation step	Button-pressing order	Instruction	Screen display
Enter main menu and level 1 submenu	1 Confirm Enter	During real-time monitor, press to open the password prompt, type in the correct password, then the menu will auto open.	
	2 Direction arrows ▲▼▶◀	Use arrows to select Icon Choice.	
	3 Confirm Enter	Press Enter to select choice	
Enter level 2 submenu	4 Direction ▲▼▶◀	Use arrows again to select #2 submenu choice	
	5 Confirm Enter	Press Enter to select level 2 submenu	
Set menu contents	1 Use Direction Arrow ▶	Select the option to be revised, flashing item is the selection.	
	2 Direction ▲▼	Use Up/Dn arrows to revise the settings.	
	3 Press Enter	Save is flashing, choose to confirm whether you want to keep the revised setting and press Enter again.	
Exit the current menu	Direction Arrow ◀	Return to the last option of the current menu	
	Cancel ESC	Exit to the last level menu	





☞ You can set the multiple channels before you exit the current menu and save all the settings together.

Main menu	Menu level 1	Menu level 2	Remarks
SEARCH 	RECORD 	CH 1 DATE 24-10-2003 TIME 2:20 PM PLAY START	Use DIRECTION arrows to perform settings in menu level 2 See details at 6.4.1
	LIST 	CH 1 DATE 24-10-2003 TIME 2:20 PM LIST SEARCH	Use DIRECTION arrows to perform setting in menu level 2. See details at 6.4.1
	ALARM 	CH 1 DATE 24-10-2003 SEARCH START	Records associated with Alarm Inputs. Not able to search motion detection records. See details at 6.4.1
INFORMATION 	FILE INFO 	HDD NUM 0 2 HDD CAP 0160086 M FREE SPACE 000000 M FILE START 2003-04-12 01:20AM FILE END 2003-05-13 03:30PM	Information cannot be modified
	HARD DISK STATE 	INDEX 1 2 MASTER W - SLAVE R - USB STATE NO	
	VERSION 	VERSION ID 1.11 ISSUE DATE 08-11-2003 WEB VERSION 1.23	

5. Menu Overview

Main menu	Menu level 1	Menu level 2	Remarks
SYSTEM SETTING 	GENERAL 	DATE 10-28-03 FORMAT MM-DD-YYYY TIME 12:22:01 FORMAT AM/PM SAVE SAVETIME HDDFULL OVERWRITE RECORDLEN 60 MIN REMOTEADDR 008 SAVE CANCEL	See details at 6.4.3
	SCHEDULE 	CH 1 WEEK S M T W T F S TIME1 00:00 – 24:00 STATE ON TIME2 00:00 – 24:00 STATE ON SAVE CANCEL	See details at 6.4.3
	IMAGE 	MODE AUTO FRAMERATE AUTO CH 1 QUANTITY 4 VIDEO LOSS OFF NO TIP SAVE CANCEL	See details at 6.4.3
	ALARM 	CH 1 TYPE NORMAL CLOSE RECORD CH 1 2 3 4 ALMOUT 1 2 3 DELAY 1SEC TIME1 00:00 – 24:00 ON TIME2 00:00 – 24:00 OFF SAVE CANCEL	See details at 6.4.3

Main menu	Menu level 1	Menu level 2	Remarks
SYSTEM SETTING 	PANTILT CONTROL 	CH 1 PROTOCOL NONE BAUDRATE 4800 ADDRESS 108 SAVE CANCEL	See details at 6.4.3
	NETWORK 	IP 192.168.001.108 SUBNETMASK 255.255.255.000 GATEWAY 192.168.001.001 WEB PORT 00080 TCP PORT 37777 MONITOR TCP PLAYBACK TCP SAVE CANCEL	See details at 6.4.3
	MOTION DETECTION 	CH 1 DELAY 30 SEC ALMOUT OFF SENS NORMAL AREA SET TIME1 00:00 – 24:00 OFF TIME2 00:00 – 24:00 OFF SAVE CANCEL	See details at 6.4.3
ADMIN SETTING 	PASSWORD 	GUEST * * * * * CONFIRM * * * * * MANAGE * * * * * CONFIRM * * * * * SAVE CANCEL	Only the Administrator password logged in is able to change password. See details at 6.4.4
	FILE DELETE 	PASSWORD -----	See details at 6.4.4
	OTHERS 	ALARM TIP OFF SHUT PASSWORD OFF MONITOR OSD ON MAINTENANCE WEEK S M T W T F S MAINTENANCE TIME 03:10PM SAVE CANCEL	Change the setting on playback; Turn on/off the alarm notification server; Turn on/off shutdown restriction
	DEFAULT 	LOAD DEFAULT CONFIGURATION? YES NO RESET NETWORK USER TO DEFAULT? YES NO	See details at 6.4.4

Main menu	Menu level 1	Menu level 2	Remarks
BACKUP  BACKUP	BACKUP RECORDS  BACKUP RECORDS	DEVICE USB CH 1 BACKUP SPEED NORMAL STARTING DATE 2003-3-18 STARTING TIME 12:18PM ENDING DATE 2003-3-18 ENDING TIME 5:18PM BACKUP ADD START	If there is no backup device, the system will indicate: NO BACKUP DVE See details at 6.4.5
	DELETE BACKUP  DELETE BACKUP	DEVICE USB DELETE CONFIRM	
LOGOUT  LOGOUT			

6. Menu Operation Description

6.1 Recording Operation

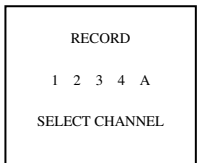
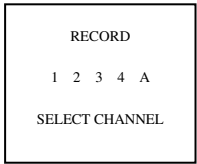
Model	Button-pressing order	Instruction	Display
DVR0414	1. Record REC	Manually start/stop recording. Use number keys to toggle between On/Off (The numbers keys on the front panel are – from 1 to 5: ◀, ▶, / , ▶▶, and ▶▶▶)	
	2. Related number key	Press to toggle the recording state on/off. The highlighted Camera # means Record On or selected to Record.	
	3 Enter	Press Enter key to save the setting.	

6.2 Playback operation

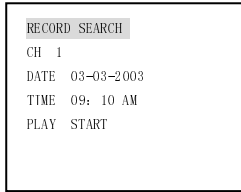
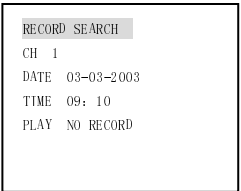
Button-pressing order	Instruction	Display
1 Play/Pause	Shortcut to the SEARCH menu. (if logged out, log back in with password) NOTE: If the channel is in recording mode, system will ignore this action.	
2 Play/Pause	Press twice to begin the playback (The on screen video displays channel, date, time). If display shows no record found, the operation will not take effect. After the completion of the playback, display shows “Play End”.	



Fn key during the playback will shift between Full Screen Mode and 5-Window Mode

6.2.1 Playback fast play

Button-pressing order	Instruction	Display
1 Fast play ▶▶	During playback press this key to shift between 2X speed, 4X speed, or 8X speed.	

6.3 Control of Pan-Tilt and Zoom Cameras

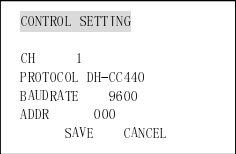
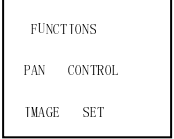
***The PTZ Camera # must be selected on DVR before you can control the camera from the DVR or remotely.**

Button-pressing order	Instruction	Press Fn to display
<p>1 Refer to menu operation at 6.4.4</p>	<p>In Control setting select the related Channel and Protocol, see the right picture. Set the Baudrate and Address of the PTZ Camera. Press Enter to save.</p>	
<p>2 Assistant function Fn</p>	<p>When in real time monitoring Mode, press Fn to show the right picture. Move ▲▼ to select PAN COTROL. Or IMAGE SET. PAN COTROL Press Enter to show DIRECTIONS Press Fn continuously to shift among DIRECTIONS, LENS CONTROL (ZOOM FOCUS IRIS), LIGHT CONTROL (OFF ON). Use arrows to adjust. IMAGE SET Press Enter to show VIDEO SET DEFAULT. DEFAULT is a factory default. SET is to be done by user. Press ◀▶ to shift between SET and DEFAULT. When SET is selected, press Enter to do BRIGHTNESS setting. Press ▲▼ to change numbers. Press FN to shift among BRIGHTNESS, CONTRAST, HUE, and SATURATION. Press ESC to exit setting.</p>	
<p>3 Direction ▲▼◀▶</p>	<p>Control the related pan-tilt, lens and light. Use Arrows to select.</p>	

6.4 Menu Operation Detail

The following Menu settings must be saved before the changes take effect.

6.4.1 Record search

The menu for record search is pictured at the right.

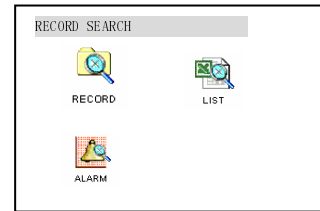

Record

First set the channel#, then date and time you want to search, and then select **START**, the playback begins.

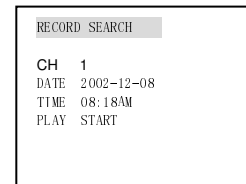

List

First set the channel #, date and time you want to search, and then select **SEARCH**, the screen shows the 8 recording files following the searching time. Use ▲▼ to select the file to be played. Press **ENTER** to begin the playback.

Note the letters before the record are equal to following

R—Record M—Motion Detection A—Alarm

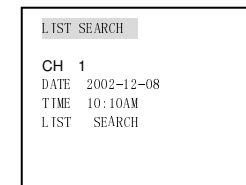

Alarm

First set the search date, then select **START**, all the alarm records will be displayed. Press ▲▼ to select the record. Press **ENTER** to play the alarm record. Note: motion detection alarm can not be searched in this category, but can be searched in **RECORD** and **LIST**.

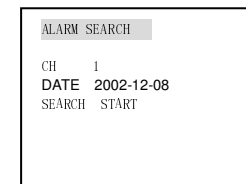

6.4.2

Menu of Information is pictured at right.

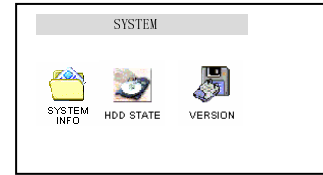
**File Info**

Display HDD number HDD capacity, remaining space, recording start time (the earliest recording time among all the HDDs) and recording end time. The information cannot be changed.

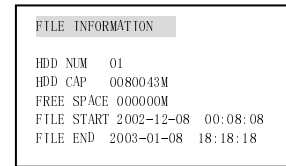
**HARD
DISK State**

Display HDD index and the conditions of master drive and slave drive.

Note: The HDD being used will be shown as "W".

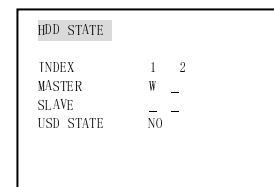
**Version**

The issuing date and ID of the operating system. The information cannot be modified.

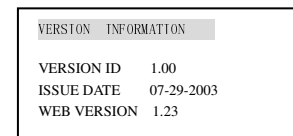

6.4.3 System Setting

Picture of the System Setting Menu

See screen shot at right:

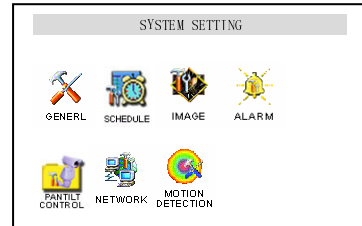

General

DATE and **TIME** are used to modify the current system date and time; after the modification reserve the change by selecting **SAVETIME**; in **HDDFULL** if selecting **OVERWRITE** system covers the previous recording files; **RECORDLEN** can set the length of each recording file(15 mins, 30 mins, 60 mins)Note: 15 minutes is suggested.

Note: System time shall NOT be changed freely; otherwise it would cause the malfunction of recording search.

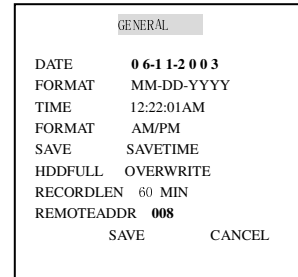

Schedule

Select the corresponding channel in **CH**. In **WEEK** the letter of each day is chosen, when the letter displays are highlighted. **TIME1** and **TIME2** express the timed recording period of the current channel. **TIME2** should be after the ending time of **TIME1**. The setting range is 00:00-24:00 **STATE** ON means the time setting is on. OFF means the time setting is OFF.

Note: 1: If you need to record all day long, set **TIME1** as 00:00-24:00 & state is on; set **TIME2** as off. 2: When setting time in **WEEK**, several days can be set at the same time.

When reviewing a certain channel's timing, only the current day will be highlighted.

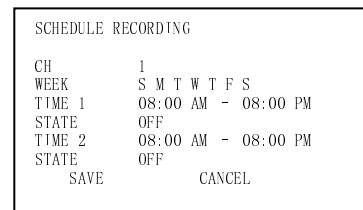

In MODE there are two modes AUTO and LIMIT. Under the mode of AUTO, recording rate is equally divided to each recording channel. On the net, for those channels not recording, its monitoring picture won't be shown on the screen. In **CH** option select the related channel. **Image quality** shift in 6 different level of image quality, the image quality of the sixth level is the best. (see the attached form the occupation space of HDD at different level). **Video Loss** is to select the alarm ON or OFF when video is lost. Off means Alarm link output is closed. On means Alarm link output is open. ALMOUT1, ALMOUT2, ALMOUT 3 correspond to link output 1, 2, 3 port. NOTIP means alarm notification is closed when alarm occurs while TIP means it is on. Setting can be done each channel respectively.

Select the relevant Camera in **CH** (this recorder has 4-Ch alarm input). **TYPE** has NO (normal open) NC (normal close) output modes. If the Camera number in RECORD is selected, recording would be started for that Camera automatically when there is alarm input. If the alarm output port is chosen, it will trigger the corresponding relay when there is an alarm input. **DELAY** means to extend the recording time after receiving alarm signal clears. 10, 20, 30 90SEC delays. When the outside alarm is cleared, the system will extend the recording time automatically before closing alarm and relay output. When Time 1 or Time 2 are on, if an alarm occurs within the time of these settings, the recording will be triggered by alarm signals. The beginning time should be

ear not the
 5059 3.99(1)Tj 2.52488 0 Td ()Tj 3.72721 0 Td ()Tj 4.4486 0 Td
 8830 Td (0)Tj 4.4486 0 Td (e)

Network **IP** is set by using ▲▼ or input the exact numbers to change the IP address. IP address setting can only be here. The related **SUBNETMASK** and **GATEWAY** should be set according to the IP address. **MONITOR** and **PLAYBACK** can be changed by using ▲▼TCP/IP or MULTICAST. Save the setting in **SAVE**, and restart the recorder.

Note:

TCP Protocol: All users are able to monitor any channel. User shall select Camera # desired. If the transmission is over Internet, TCP should be chosen. 2 users can log in at a maximum.

NETWORK SETTING	
IP	192-168-000-141
SUBNETMASK	255-255-255-000
GATEWAY	192-168-000-001
WEB PORT	00080
TCP PORT	37777
MONITOR	TCP
PLAYBACK	TCP
SAVE	CANCEL

Motion detection Select the Camera channel in **CH**. **ALMOUT** controls the alarming state for motion detection. **SENS** has three levels: LOW, NORMAL, HIGH. **AREA** can be accessed by pressing **ENTER**. The setting area can be divided in 192 sections. Red section means the current cursor position, and the blue section is the motion detection area. Areas with no color are no motion detection areas. Press **Fn** to locate the current section, and then move the cursor to cover the MD area needed; press **Fn** again to choose the MOTION DETECTION area. Press ▲▼ to get the setting and press **ENTER** to confirm.

MOTION DETECTION SETUP	
CH	1
TIMING	30SEC
ALMOUT	OFF
SENS	NORMAL
AREA	SET
SLOT 1	08:00 AM - 08:00 PM ON
SLOT 2	08:00 AM - 08:00 PM Off
SAVE	CANCEL

6.4.4 Admin setting

Menu of Admin setting is pictured at Right:

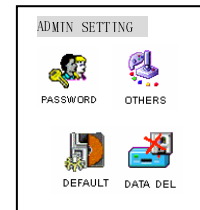

Password

Select **GUEST** and **MANAGE**. Press ▲▼ or the number key to change the password, and then confirm the change by inputting the password again. Press **ESC** to go back to the sub menu. Only **MANAGE** level user can change the password.

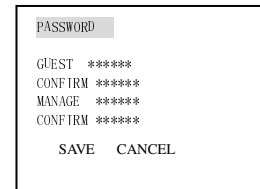

Others

PLAYMODE has two modes, **VIDEO BEST** (the best flow) and **AUDIO SYNC** (the best synchronization). When **Alarm indicator** light is on, if there is external alarm input, then alarm information comes out; When **Alarm indicator** light is off, alarm information won't come out. If **SHUT PASSWORD** is ON, correct manage level password is needed to be input before turning off the power of DVR. If **SHUT PASSWORD** is off, the DVR will be closed 4 minutes after pressing the power button. **MONITOR OSD**, when it is on, real time monitoring channel characters are displayed while it is off, no display.

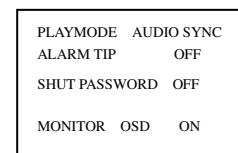

Default

Press ▲▼ to get the setting and press **ENTER** to confirm. Press ◀▶ to confirm YES or NO. After the default setting is selected, system will restore the original Factory Default settings. Or restore to the original net user name and password.

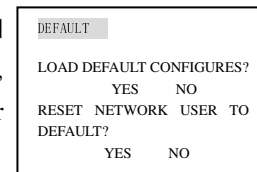

File delete

Used to clear the data in the HDD. Be careful with this item. Before you delete the data, you have to input the manage password.

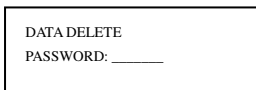

6.4.5 Backup

Menu of Backup is pictured at Right:

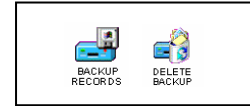

Backup records

Move the cursor to select the backup device, channel number, backup speed, starting data and time, ending date and time, and then select to start the backup, and system will display the backup processing. If the user does not connect the backup device correctly, the system will display: **No backup disk**; if the device is full, it will display: **Disk is full**. During the backup, it will display the time. For the backup device you can choose among HDD/USB/CDR. If HDD is chosen as the device, the backup speed can be selected between **Fast** and **Normal**. If the backup speed is **Fast**, system will stop the current recording.

```

BACKUP RECORDS
BACKUP DEVICE  USB
CH             1
BACKUP SPPED  NORMAL
STARTING DATE  2003-3-18
STARTING TIME  9: 18AM
ENDING DATE    2003-3-18
BACKUP        ADD  START
  
```

Delete backup

Select the backup device you want to delete the records from first, and then confirm the deletion by selecting **Yes**.

```

DELETE  BACKUP
DEVICE  USB
DELETE  CONFIRM
  
```

6.4.6 Logout

Press Enter to logout.

```

Logout
  
```

Chapter 5 Operation Over Network

There are two ways to access the DVR over the network: Using Microsoft Internet Explorer (IE) or Mace Remote Client Software.

Using IE, no special software needs to be installed on the PC. A web control unit will be downloaded to the computer automatically the very first time a connection to DVR is initiated.

The Mace Remote Client Software needs to be installed properly to use the second option. But the graphical user interface menu items are identical. The Remote Client software is included on the utility CD in the accessory box, or you can directly download/install from <http://www.mace.com/>, under **Support**.

- 1. Setting up the Client End**
- 2. Login and Logout**
- 3. Operation of the Right Click Menu Items**
- 4. Record Search**
- 5. System Configuration**
- 6. Assistant**

1. Setting up the client end

No special software is needed to install on the DVR, PC or other devices in order to access DVR using the IE browser. If the IE responds back “Page Cannot Be Displayed” or “Server not Found”, check your network connection carefully.

2. Login and logout

Please input the IP address of the DVR in the address column of the browser. Take the DVR’s IP address: 192.168.0.168 as an example: Input <http://192.168.0.168>. Note: The first time you visit this DVR the system will pop up the dialogue box to ask whether you accept ActiveX or not, and please choose Yes, and then the system will install the software automatically.

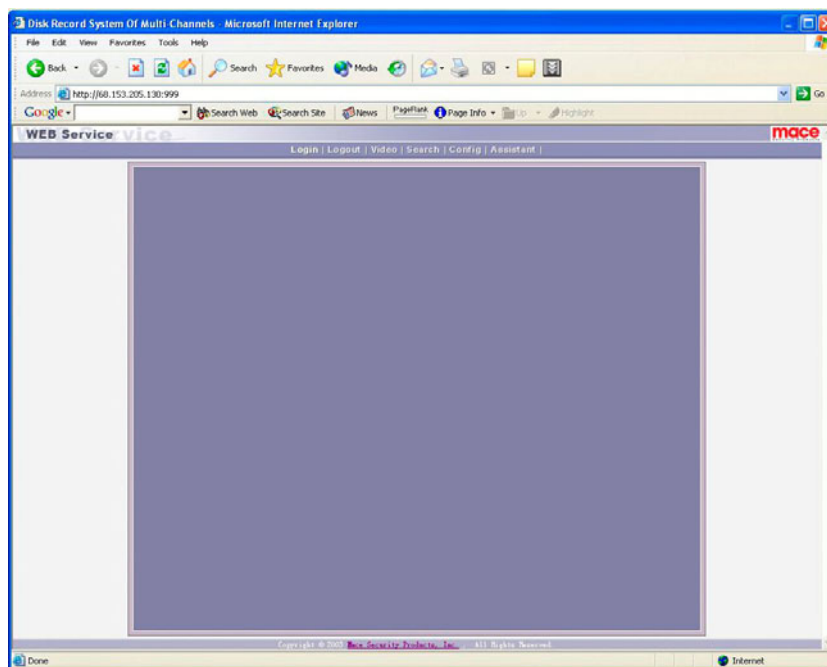

On the remote monitor display, there is a monitor video window, with selection choices: [login](#), [logout](#), [search](#), [config](#)(system setting), [Assistant](#)(assistant setting) and so on.

Login: Please select [login](#), and the following dialogue box will pop up.

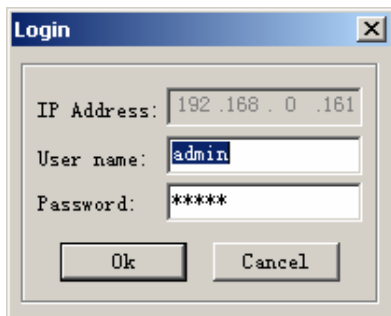

Input the username and password. There are three types of Users: Administrator, User, and Guest. For detailed information please refer to [User manage](#)的 in Assistant setting. The default username is admin, & password is admin. For Security purposes, please change the administrator password.

If after the input of the username and password, the following box pops up (6-3). The system is indicating that some other user has used this name and is logged in. Please use another name to log in.



6-3

If after the input of the username and password, the following box pops up. The system is indicating that the name or Password input is incorrect, please try again.



6-4

Log out: If the logged in user needs to log out, please click logout button. The popup dialogue box appears. Please choose Yes. See 6.5.



6.5

3. Operation of the Right Click Menu Items

After you log in as Administrator, the buttons of login , video, logout, search, config & Assistant are activated. Click the right mouse key and the following interface Display:

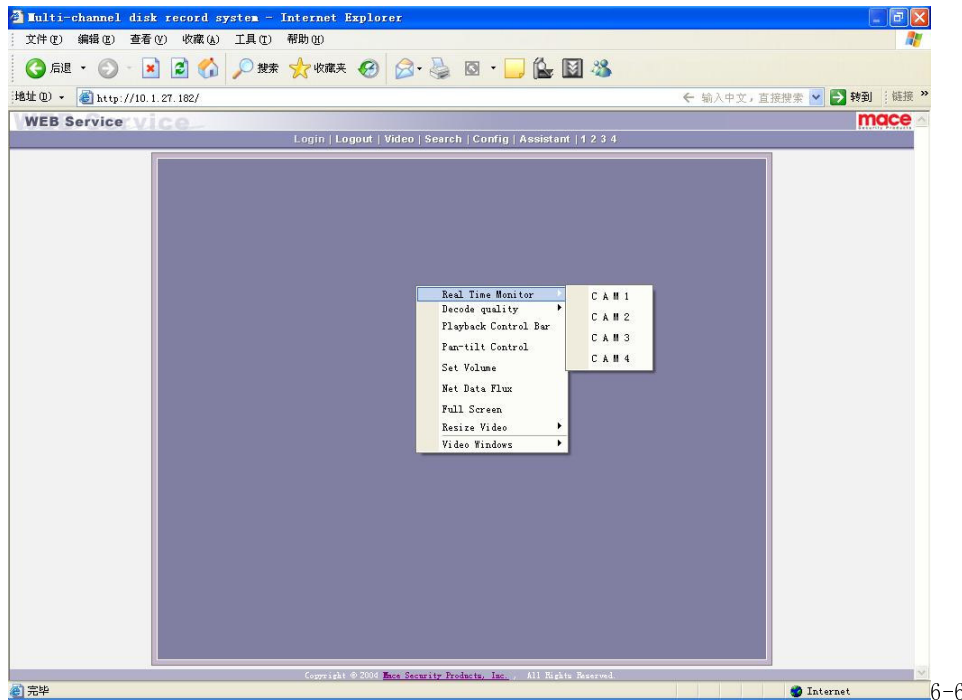

The right key menu includes: Real time monitor, Decode quality, Video windows, Playback control bar, Pan-tilt control, Set volume, Net data flux, Full screen, Resize video and so on.

Real time monitor Among the displayed channels, you may select the channel you want to see.

Note: When the recording mode is set to MODE (under **Menu/System Setting/Image**), over the network, users will only be able to view the channels that are scheduled (or set to be event triggered) to record at the time. For example, if only Channel 2 and 3 are set on motion detection triggered recording at the time and the other two channels (Channel 1 and 4) are configured recording off, remote users will not be able to view live images from Channel 1 and 4 over the network

Playback control bar Please refer to **Records playback**.

Pan-tilt control The Arrows control the moving direction of the pan-tilt and the zoom, iris & focus of the lens. See 6.8. Press the related buttons to control. Note: Before the PTZ will operate you must set the correct protocol of the pan-tilt on the DVR configuration menu.

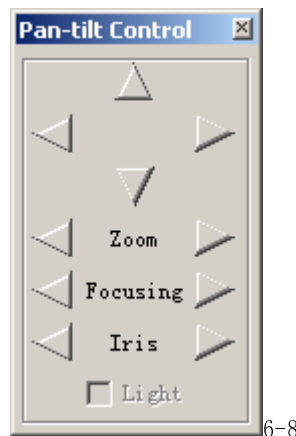

Set volume Audio volume is User selectable. User can drag the bar to adjust or select Mute to cancel the sound.

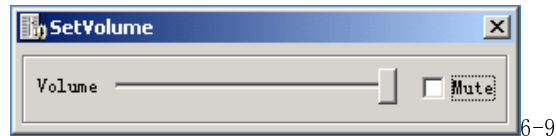

Net data flux Display the statistics of the network transmission data flux. When there is no network data transmission the statistics shows zero.

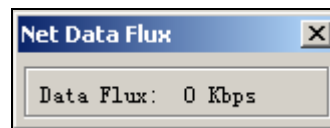

Full screen There are two ways to view full screen monitor: One is to double click on the blue window directly; the other is to select Full screen among the right click menu items. During multi-window state, choose one of the windows and double click it for full screen display.

Resize Video User can select different ratio to show different size of the video picture.

4. Records Search and Playback

Click on search, and then fill in the required info on the pop up dialogue box for the records search.

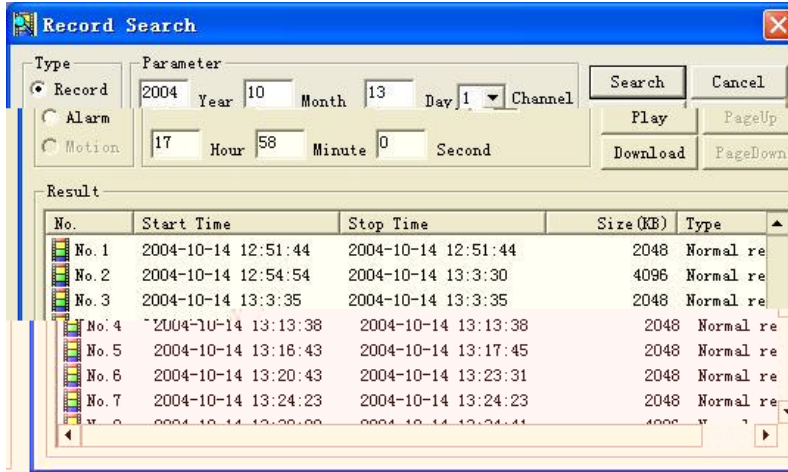

6-11

Input recording time, channel number and searching type: Record or Alarm Search, and the results will display in the dialogue box. It displays 15 records from the search time and forward. Click **Pageup** and **Pagedown** to display the matched records. Double click the desired record, and system will play the selected record. At the same time you can also perform a record download, and the record will automatically be saved in your PC's "C:\Download" folder.

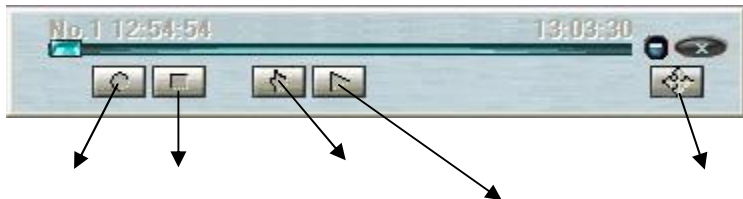

Save record stop save capture picture replay record full screen

During the playback, you can operate the buttons in the playback bar such as: save record, stop save, capture picture, full screen. During the playback on the video screen, the video can indicate the channel number, time and data flux of the record.

Download See 6-12, select the desired record and click **Download**.

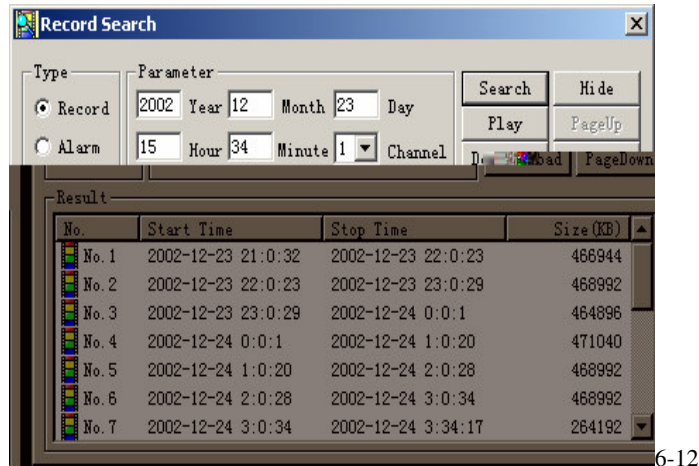

The software supports the downloading of several records simultaneously. The default format of the downloaded records' name is: file name, Channel #, date, time, extension name is .mp4 (Example: a-0120021205071028.mp4, 01 means channel 1, 20021205 means December 5th of 2002, 071028 means 7 o'clock 10 minutes 28 seconds).

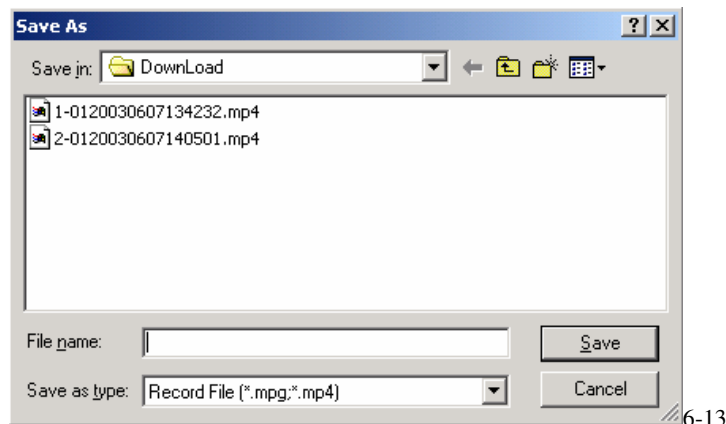

To Save a file located in the Search Record Display, Select File, press the Download button. A Save Window opens. Input the file name and choose **Save**. The screen shows the processing of the downloading until the completion.

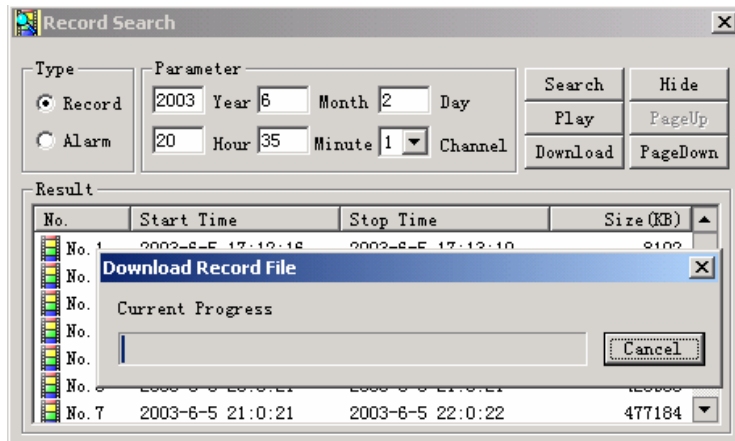

6-14

5. System Configuration

Click **Config** button and a pop up the dialogue box appears. There are **General**, **Schedule**, **Image**, **Alarm**, **Motion Detection** tabs of the five menu configuration screens.

Note: The grayed part of the menus that cannot be changed can only be modified directly at the DVR.

General: Include the recording length setting. In Control Column select the channel number and its PTZ decoder's protocol, as well as the related address for the control of the PTZ Camera.

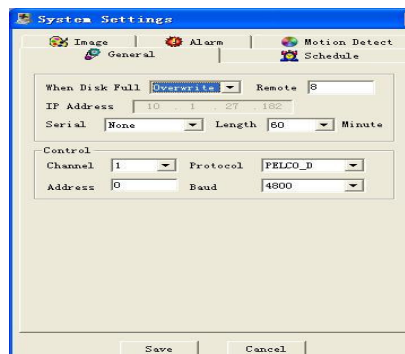

Sched

 With this menu, user can select the recording mode and the level of quality for each channel.

Style: There are two recording modes: LIMITED and AUTO. Under LIMITED mode, each channel is allocated 7.5 frames per second. All channels will be recording at the fixed frame rate disregard the number of channels that are actually recording.

Under AUTO mode, the total 30 frames per second are evenly distributed among the channels that are in recording mode: 1-ch: 30 fps; 2 channels: 15 fps per channel; 3 channels: 10 fps per channel; 4 channels: 7.5 fps per channel. A channel that is set to be event-driven during the time period (alarm or motion) is considered as in recording mode and the system will set aside resources (# of fps) in case it is triggered.

There are six levels of image quality. Level 1: data flux 128Kb/S, Level 2: 256Kb/S, Level 3: 384Kb/S, Level 4: 512Kb/S, Level 5: 768 Kb/S, Level 6: 1Mb/S.

The different data flux demands on the related bandwidth and the transmission image quality is also different. Among them, Level 6 demands on the highest bandwidth and has the best image quality.

Net transmission Protocol- There is TCP and Multicast (two types). Multicast protocol: the 1st user logged in has control power, can view the image at will and other users can only follow this user to view the image. 5 users are allowed to view at the same time. TCP protocol: each user can view the image at will. According to the need, users can choose between different protocols. If viewing is through the Internet you must choose TCP. Up-to 5 users are allowed to view at the same time.

Alarm When there are alarm input signals, the user can select the recording channel(s) and the output port for the actual need.

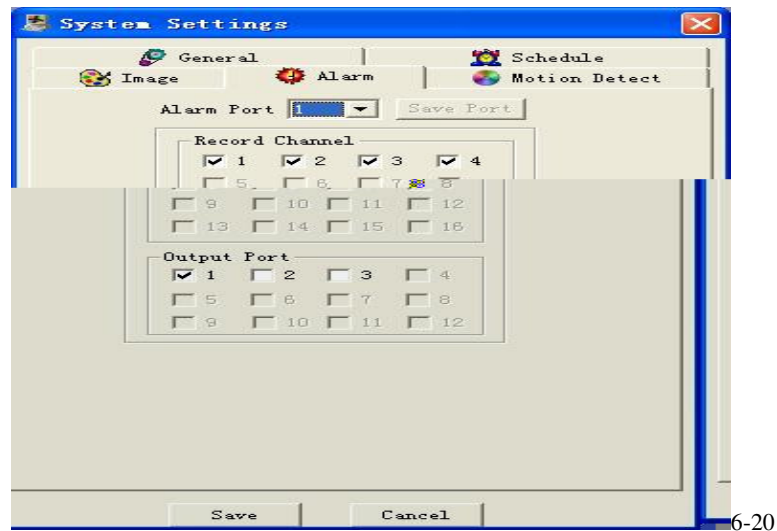

Motion detection When the user sets the time period for Motion Detection, the motion detection will take effect. The blue area is the selectable motion detection area. The User can move the dialogue box to choose the correct area and can also set the sensitivity of the area due to the need. Click **Full screen** or press right key on the area to display the motion detection area in full screen mode. After setting the area the user can **Save channel** or **Clear** the area. The Alarm output field allows you to activate an output relay. The default port is 2. If you want to set this channel fully as motion detection recording, you have to turn off the **timing** recording of this channel.

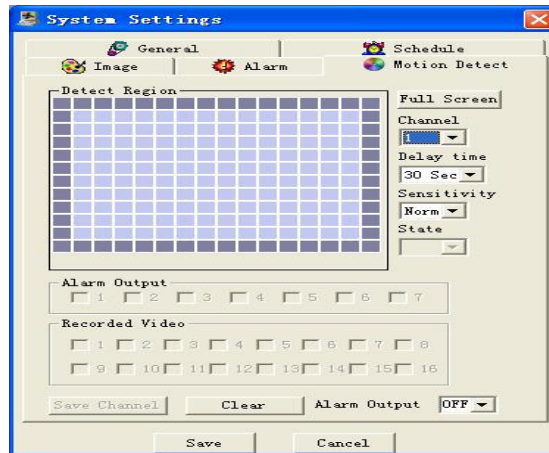

6-21

Note: If there is an overlap between the motion detection time period and the recording time period as defined under Schedule (under **Menu/System Setting/Schedule**), continuous recording will take priority

6. Assistant

Assistant Click on Assistant setting, as following, there are **User manage** - **Record control** - **Apply for control right** - **Log information** - **System information** - **Channel name** - **Upgrade BIOS**, etc.



6-22

User manage: displays the user (Log-In) information of the DVR. The buttons to the right can let an administrator user save, add, modify, delete and cancel the information.

Three levels of user types: Administrator — fully set the system, manage the users to the system; User — can not set system parameters or modify other users' information. This User can select and operate existing programming; Guest — can not set system parameter and records search, can only views the channel that the system administrator/user is viewing.

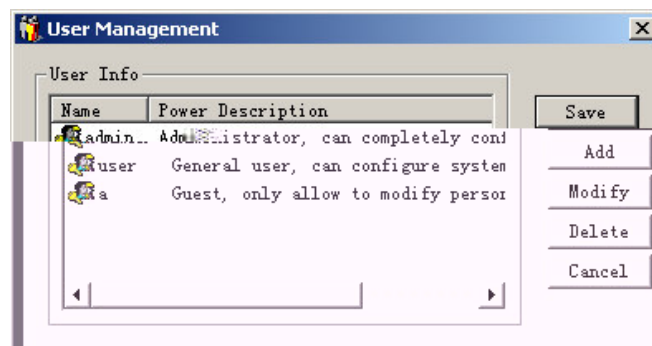

6-23

Add: Click Add to show the following dialogue box:

The 'Add User' dialog box has a title bar with a close button. Below the title bar is a 'User Info' section with four input fields: 'Name', 'Password', 'Confirm', and 'Power'. The 'Power' field is a dropdown menu. At the bottom of the dialog are 'OK' and 'Cancel' buttons.

6-24

The Admin User can add user information in this dialogue box, assign the user power level. **Note:** There is only one administrator allowed.

Modify: Select this button to show the following. User can modify the filled-in information.

The 'Modify User' dialog box has a title bar with a close button. Below the title bar is a 'User Info' section with four input fields: 'Name' (containing 'admin'), 'Password', 'Confirm', and 'Power' (set to 'Administrator'). At the bottom of the dialog are 'OK' and 'Cancel' buttons.

6-25

Record control: Manually control the recording of each channel.

The 'Record Control' dialog box has a title bar with a close button. Below the title bar is a 'Record' section with four rows of controls for Channel1, Channel2, Channel3, and Channel4. Each row has two radio buttons: 'Stop' and 'Start'. The 'Start' radio button for Channel4 is highlighted in pink. To the right of the controls are 'OK' and 'Cancel' buttons.

6-26

Apply for control power Web client software can supply the login of multiple users. If you want to have the control, you can click this option and confirm to have the control. (6-27). If a new user wants to have the

control, the new user has to apply and gain the authorization of the existing user with control. If the logged-in users are all normal users, the first logged-in user gains the control power automatically. If a higher lever user logs in later, they can gain the control power automatically. If only one user logs in or the logged-in user is the user with control, the box is gray.

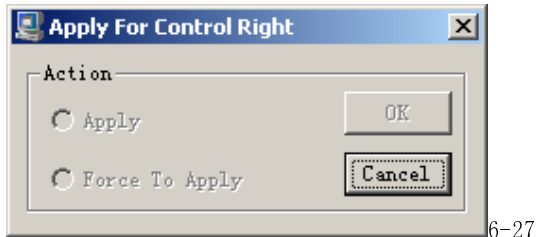

6-27

The picture below (6-28) is the pop-up window when other user send request to the existing user with control.

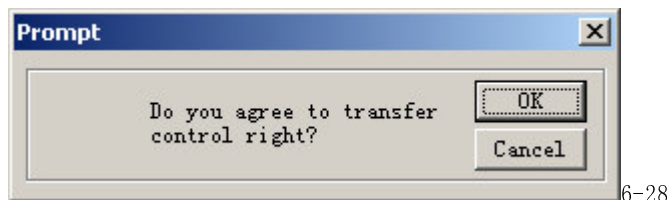

6-28

Log information: The operations on the system are all recorded in log information.

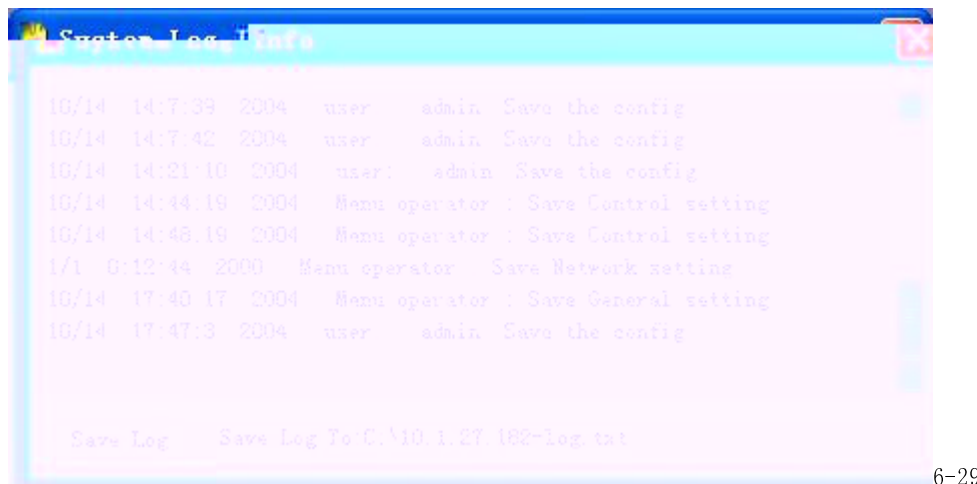

6-29

System information: Check the basic information of the system. When sound is not needed, you can turn off the audio. Due to the bandwidth considerations, the user can select the different Video transport modes, Video type PAL or NTSC has to be selected correctly, 110vac, 60hz is normally NTSC, 220vac, 50hz is normally PAL. If Auto recycle monitoring is on, system will sequence between all the channels automatically with a user selectable dwell time. **Net data flux:** during real-time monitor will display the statistics of the network data flux.

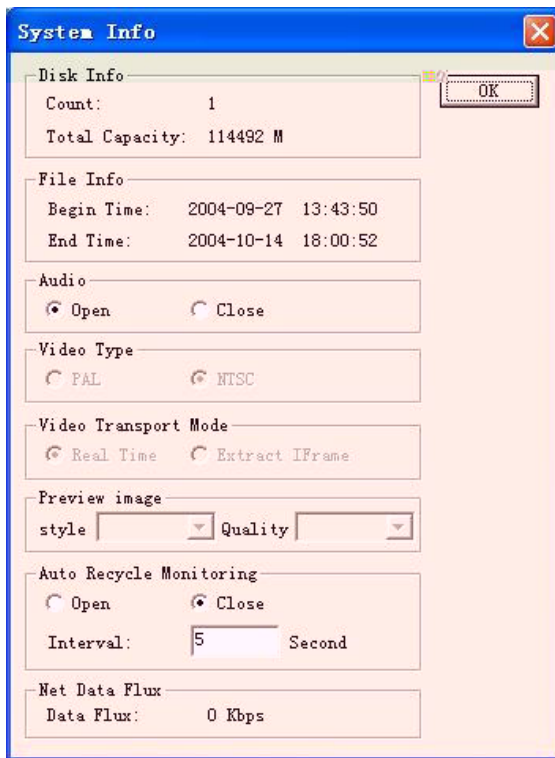

6-30

About: Version information – This palette displays information about the DVR and may be vital when contacting MACE Support.



6-33

Chapter 5 System Connections

1. DVR Rear View
2. RS-485 Port Connection

1. DVR Rear View

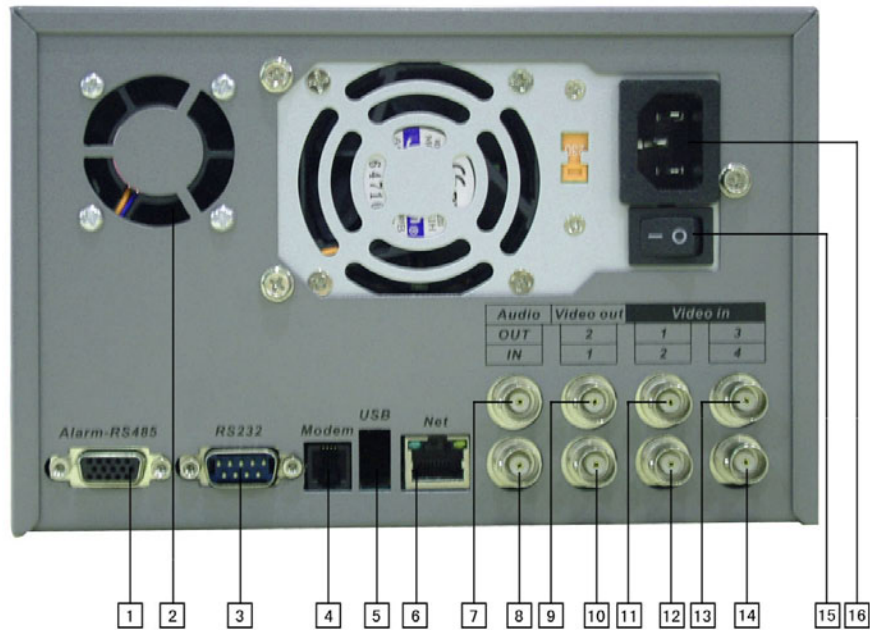

1- Alarm – RS485 (DB-15)	2- Fan	3- RS232 (DB-9)
4- Internal Modem (Not available)	5- USB	6- RJ45 (10 Base-T)
7- Audio Out	8- Audio In	9-10 Video Out (BNC)
11-14 Video In (BNC)	15- Power Switch	16- Power Socket

Network connection note: When connecting directly to the network card of a computer, please use CAT-5 Crossover Cable; when connecting to a LAN or Router use CAT-5e cable.

3. RS-485 port connection

If you want to control Camera pan-tilt-zoom (P/T/Z) or activate the DVR Output relay, the 25-pin RS485 connection must be used. See detail below.

The RS485 port connection can control various (P/T/Z) Cameras, and the specific model or protocol can be selected from the Control Menu in System settings.

The DB25 pin outs are marked below. The definition of the pin outs are as follows: The broken line in the graph indicates inside connection that have already been wired.)

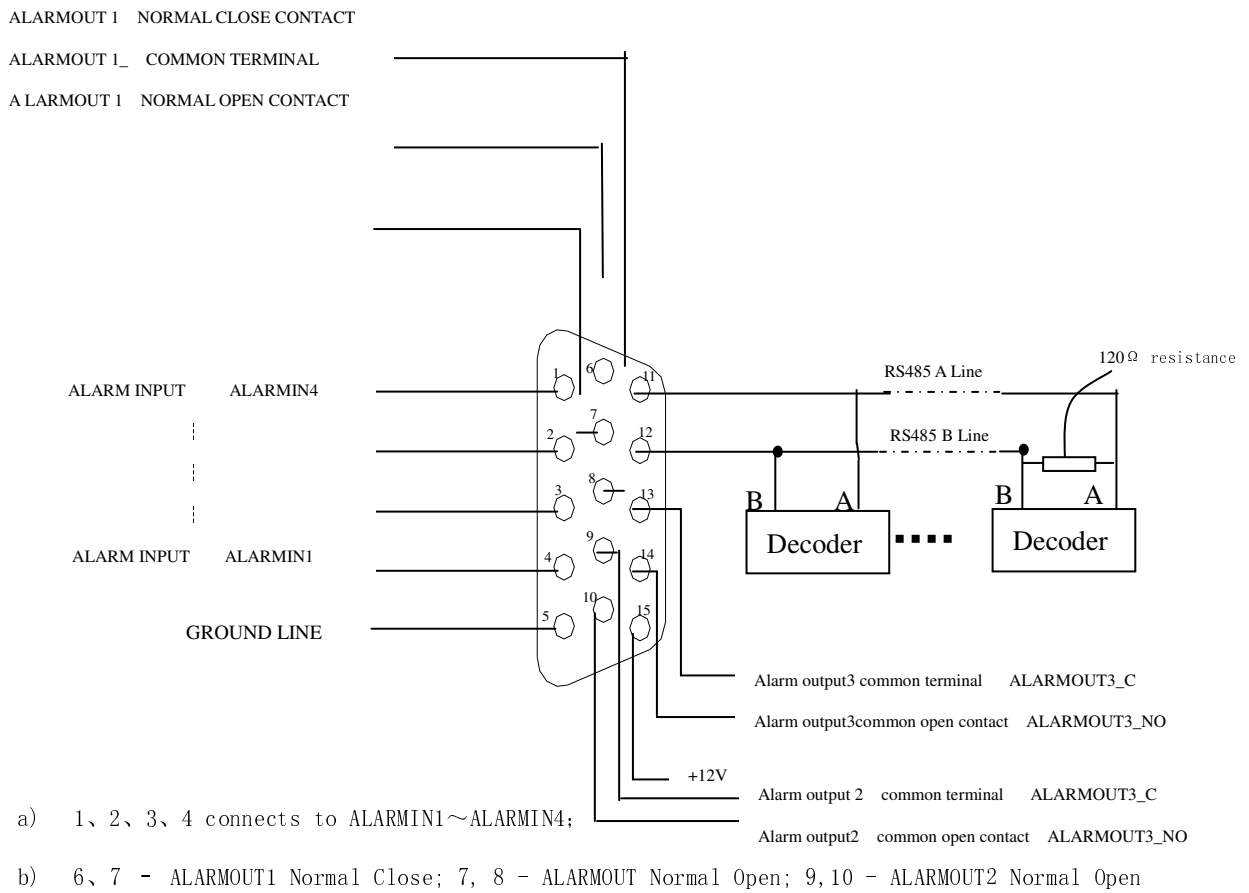

- c) 14, 15 - +12V Power, Can also provide power for alarm sensors; 5, 13 - Grounds
- d) 11 - RS485 A line, 12 - RS485 B line;

- Connection of the alarm input:

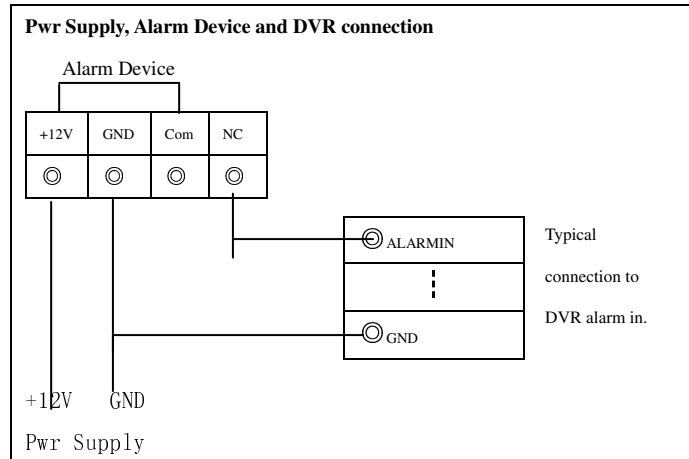

• Instruction of the alarm input end:

8 channel alarm inputs with NO or NC alarm (normally open or normally close type). The power out of the alarm sensor can be provided by the DVR (Low current only) or (External alarm power supply)

• Instructions for alarm device power from DVR:

N/O or NC alarm outputs refer to information below.

• Instruction of the controllable +12V

Available for Low Current Power to Alarm devices.

① Instruction of RS485 A & B line:

Used to connect the A and B line of the PTZ units.

Module sketch of the alarm input end

Module sketch of the alarm output end

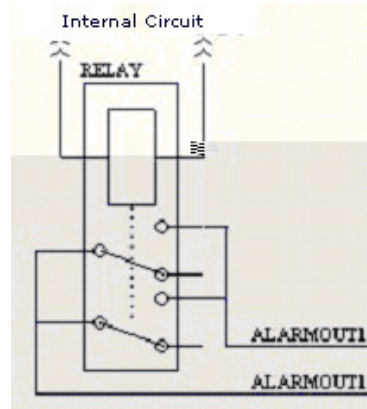
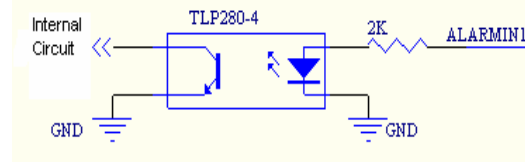

• Relays' parameter of the alarm output end

Model: G6H		
Relay Material	Silver	
Rating, resistance & load.	Rated switch capacity	30VDC 1A, 125VAC 0.5A
	Maximum switch power	62.5VA 33W
	Maximum switch voltage	125VAC, 110VDC
	Maximum switch Current	1A
Insulation	Pins with same polarity	750VAC 1minute 50/60Hz
	pins with different polarity	1000VAC 1minute 50/60Hz
	between relay and loop	1000VAC 1minute 50/60Hz
Surge voltage	between relays with same polarity	1500V (10×160us)
Length of open time	3ms max	
Length of close time	3ms max	
Longevity	Mechanical	100×106 (10Hz)
	Electric	200×103 (0.5Hz)
Temperature	-40~+70°C	

Appendix 1 Frequently Asked Questions

1. After Power up, "No HDD" message is flashing on the local monitor

This is an indication that either the harddisks are not installed correctly or no harddisk is installed at all. Refer to Appendix 2 **Hard disk installation**. Also inside the DVR there is a yellow sticker with instructions on harddisk installation.

2. When I power down the DVR, why do I have to press and hold the power button for 4 seconds?

First of all, using the front orange power button to shut down the DVR will make sure the DVR properly finish and close all it operation and file system, thus eliminate many possible causes for harddisk errors leading to data loss. This is the correct way of powering down a DVR.

Secondly, requiring holding the button for over 4 seconds is to avoid accidental shutdown of the DVR due to unintended touch of the button. You can make the shutdown more secure (i.e. avoid unauthorized shutting down) by activating the shutdown password protection feature. (MENU->ADMIN SETTING->OTHERS->SHUTDOWN PASSWORD)

3. What does the sound of the buzzer mean when normally starting the machine

When the machine is started successfully, it will tone out a short ring.

When the HD can not be identified, it would tone out a longer ring.

When communication with the controller panel is abnormal, it sends out a tone of one long ring and two short in series.

4. Can I control the recording time?

The recording time unit is per day. Besides timing recording, there are other recording methods such as motion detection recording, manual recording, external event triggering recording. Confirm that each of the settings is correct.

5. The indicator light is flashing while recording?

Check the external video input signal first. Such phenomena would happen when the input signal is not standard. If it is not the input signal, it must be caused by that the reading speed of the HD is too slow. In this

situation, the current HD should be changed.

6. Why the screen is black after I switch off and on the power?

The power supply comes with the DVR has a built-in protection mechanism. After the power is shut down, you have to wait for at least 5 seconds before turn it on again. Turn off the power, wait for 5 seconds, and turn it on again. If this does not correct the problem, contact your Mace technical support hotline.

7. What kind of external equipment could be connected to the Recorder?

It can work together with various matrix units, multiplexers, switchers, quads and PTZ Domes.

Appendix 2 Hard Disk Installation

Hard disk installation

There is one 40G hard disk (HD) preinstalled in the Mace DVR, unless you ordered a special configuration. So normally you DO NOT have to go through these steps. This procedure only applies to cases where there is no built-in hard disk in the DVR or additional hard disks need to be installed.

In total, a maximum of 4 large capacity hard disks can be installed inside the machine if a CD burner is not needed. With a CD burner, there can be a total of 5 internal large capacity hard disks. User can decide the number of hard disks according to required image quality, recording time and recording length.

Installation steps



① Dismantle the fixed screw of the top cover



② Dismantle the HD Bracket

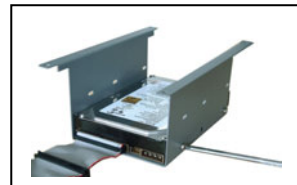

③ Install the first HD

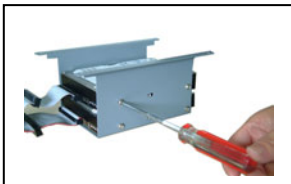

④ Install the second HD



⑤ Put back the HD Bracket



⑥ Put back the Cover Case

LIMITED WARRANTY

Mace Security Products, Inc. (MACE) warrants to the original purchaser of this product that it shall be free of defects resulting from workmanship or components for a period of one (1) year from the date of sale. Defects covered by this Limited Warranty shall be corrected wither by repair or, at MACE's discretion by replacement. In the event of replacement, the replacement unit will be warranted for the remainder of the original one (1) year period or thirty (30) days, whichever is longer. THERE ARE NO OTHER ORAL OR WRITTEN WARRANTIES, EXPRESSED OR IMPLIED, INCLUDING BUT NOT LIMITED TOTHOSE OF MERCHANTABILITY OR FITNESS FOR A PARTICULAR PURPOSE.

This Limited Warranty is nontransferable and does not apply if the product has been damaged by negligence, accident, abuse, misuse, modification, or misapplication. To be eligible for warranty service, a defective product must be sent to and received by MACE within twelve (12) months of the date of sale and be accompanied with proof of purchase. MACE does not warrant that this product will meet your requirements; it is your sole responsibility to determine the suitability of this product for your purposes. MACE does not warrant the compatibility of this product with your computer or related peripherals software.

MACE'S SOLE OBLIGATION AND LIABILITY UNDER THIS WARRANTY IS LIMITED TO THE REPAIR OR REPLACEMENT OF A DEFECTIVE PRODUCT. THE MANUFACTURER SHALL NOT, IN ANY EVENT, BE LIABLE TO THE PURCHASER OR ANY THIRD PARTY FOR ANY INCIDENTAL OR CONSEQUENTIAL DAMAGES OR LIABILITY IN TORT RELATING TO THIS PRODUCT OR RESULTING FORM ITS USE OR POSSESSION.

Free Manuals Download Website

<http://myh66.com>

<http://usermanuals.us>

<http://www.somanuals.com>

<http://www.4manuals.cc>

<http://www.manual-lib.com>

<http://www.404manual.com>

<http://www.luxmanual.com>

<http://aubethermostatmanual.com>

Golf course search by state

<http://golfingnear.com>

Email search by domain

<http://emailbydomain.com>

Auto manuals search

<http://auto.somanuals.com>

TV manuals search

<http://tv.somanuals.com>