

16-CH Color Full Duplex Multiplexer

Instruction Manual

707-V1.6(N)

Index:

1.	Safety Warning	3
2.	Introduction	3
3.	Features	4
4.	Specification	5
5.	Front Panel Keypad	6
6.	Back Panel Connection	10
7.	Menu Setting	12
7.1	Menu	12
7.2	Title Display	12
7.3	Alarm Duration	13
7.4	Dwell Time	13
7.5	VCR Record Time	14
7.6	Alarm VCR Record Time	14
7.7	INT Audible Alarm	15
7.8	EXT Audible Alarm	15
7.9	Event Message Latch	15
7.10	Security Lock	16
7.11	Set Time	16
7.12	Event List	17
7.13	Baud Rate	17
7.14	ID	17
7.15	Remote Interface	17
7.16	System Reset	18
8.	Channel Setup	19
9.	Motion Detection Setup	21
10.	Monitor Operation	24
11	Auto Switching	24
12.	VCR Playback Operation	26
13.	External Alarm Input and Video Loss Signal	26
14.	VCR Time Setting	27
15.	Record Time Flash Rate Chart	28
16.	Remote Control Function	29
17.	Connection	30
18.	Rack Mount Installation	31

1. Safety Warning

Please take a few minutes to review below safety precautions before operation.

- 1.1 Please lift and place this equipment gently.
- 1.2 Do not expose this equipment under straight sunlight environment.
- 1.3 Please keep this product away from the liquid or water.
- 1.4 When measuring current, turn the power off before connecting the meter in the circuit.
- 1.5 Do not unplug the power connector before turning the power off.
- 1.6 Do not overload outlets and extension cords as this may cause the fire or electronic shock.
- 1.7 Do not attempt to open the cover of this equipment, dangerous voltage of other hazards might occur while removing the cover.
- 1.8 Do not try to repair the product inside, any failure procedures might cause un-repairable damages (artificial damage will not be included in warranty promises).
- 1.9 Do not turn the Power On and Power Off during short time period (within 3 seconds) to let the product have good reliability.

2. Introduction

Thank you for choosing this high quality / Multi-function / color / full duplex Multiplexer. It can connect up to 16 cameras. Before attempting to connect or operate this product, please read the safety warning and the instructions carefully. Any incorrect connection or operation might cause harm or damage to this product.

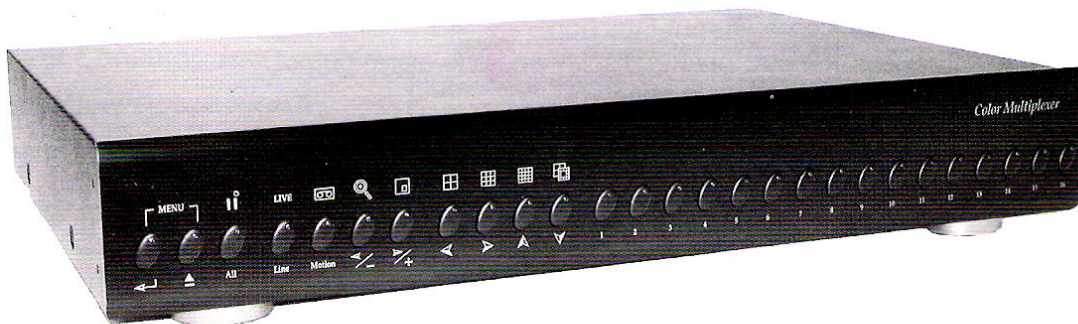

3. Features

- 3.1 Support NTSC and PAL
- 3.2 On screen menu display.
- 3.3 Full Duplex Multiplexing
 - 16 channels camera can **record/live display/playback** at the same time.
 - 16 channels loop back terminal.
- 3.4 Resolution

Screen Modes	Resolution
Full screen	704(H) x 468(V) <NTSC> / 704(H) x 564(V) <PAL>
4 channels	352(H) x 234(V) <NTSC> / 352(H) x 282(V) <PAL>
9 channels	224(H) x 156(V) <NTSC> / 224(H) x 188(V) <PAL>
16 channels	176(H) x 117(V) <NTSC> / 176(H) x 141(V) <PAL>

- 3.5 Independent main and call monitor outputs allow simultaneous multicamera and full screen viewing.
- 3.6 Multi Screen Display Mode
 - Below display modes are selectable while surveillance & VCR play back:



- 3.7 **Picture-In-Picture (PIP) is available in live and VCR playback modes, Zoom in & out can be up to 2 X 2 in live and VCR playback modes**
- 3.8 16 channels are swappable and independent title generator (up to 6 characters) for each channel.
- 3.9 **Simultaneous digital video motion detection using 15x12 target (NTSC) 15x14 target (PAL) motion detection grids for each video channel to set different options.**
- 3.10 **Video Adjustable on Each Channel**
 - 3.11 Re-flash Rate
 - Full screen : Real time display
 - 16 channels: 0.133 sec/channel
 - 3.12 Alarm Input Function & Output Function
 - 16 channels alarm input, ALARM display and one alarm output.
 - Video loss detected in each channel.
 - Records 50 events.
 - 3.13 Power-loss memory function: set up parameter will remain while power failure.
 - 3.14 Remote function: it can be controlled by external host through RS-232Co or RS-485.
 - 3.15 On Screen Display and RTC (Real time clock) Function.
 - 3.16 Call Monitor

4. Specification

Camera Input Signal	Composite video signal 1 Vp-p 75Ω BNC, 16 channels
VCR Input Signal	Composite video signal 1 Vp-p 75Ω BNC S-Video Y 1 Vp-p 75Ω; C 0.8 Vp-p 75Ω S JACK
Camera Loop Back	Composite video signal 1 Vp-p 75Ω BNC, 16 channels
Main Monitor Output	Composite video signal 1 Vp-p 75Ω BNC
Call Monitor Output	Composite video signal 1 Vp-p 75Ω BNC
VCR Output	Composite video signal 1 Vp-p 75Ω BNC S-Video Y 1 Vp-p 75Ω; C 0.8 Vp-p 75Ω S JACK
Motion Detect Area	15 * 12 targets per camera (NTSC) 15 * 14 targets per camera (PAL)
Motion Detect Sensitivity	256 Levels
Video Loss Detection	Yes
Picture Freeze	Yes
Refresh Rate	30(NTSC)/25(PAL) Frames / Sec.
Recording Rate	25(NTSC)/18(PAL) Pictures/Sec.
Dynamic Recording Priority	Yes (Programmable)
Dwell Time	Programmable (1~10 Sec)
Picture in Picture	Yes (Movable)
Key Lock	Yes
Picture Zoom	2*2 (Movable)
Camera Title	6
Video Adjustable on Channels	Color/Contrast/Brightness Adjustable
Alarm Input	TTL input, Hi (5V), Low (GND)
Alarm Output	COM, N.O.
Alarm History Log	50 Events
Remote Control	RS232 or RS485
VCR Trigger Output	Yes (TTL output)
Time Display Format	YY/MM/DD, DD/MM/YY, MM/DD/YY, OFF
Power Source	DC12V, 1.25A
Power Consumption	<10W
Operation Temperature	0°C~50°C
Operation Humidity	30%~90%
RS-232C / RS-485 (bps)	115200 · 57600 · 19200 · 9600 · 4800 · 3600 · 2400 · 1200
Dimensions (mm)	432 (W) x 76(H) x 311(D)
Weight	5,200g

5. Front Panel Keypad



Some buttons on front panel have dual functions. The primary function is listed first, followed by the secondary function (shown in parentheses). Indicator lights (LEDs) are on each button.

5.1 MENU: Press + simultaneously to enter the menu mode

5.2 ENTER: Press to enter system setup of main item selection.

5.3 ESC: Press to exit system setup of main item selection.

5.4 FREEZE:

5.4.1 Press button to freeze all screen channels.

Press to release.

5.4.2. Press + simultaneously then press Camera Select (1-16) button to confirm the Freeze location. (The freeze location number will be displayed on monitor screen. The Camera Select (1-16) is to confirm the location, not camera channel) The show on the right of location. Press the same **Camera Select (1-16)** again to release freeze function.

5.5 LIVE

5.5.1 Press **LIVE** button to setup all of the screen channels on the screen as LIVE display. Then press the below button for desirable screen modes display.

5.5.1.1 Press : to setup the 4 channels LIVE display screen.

5.5.1.2 Press : to setup the 9 channels LIVE display screen.

5.5.1.3 Press : to setup the 16 channels LIVE display screen.





5.5.1.4 Press **+4,7,9,10,13,16** : to setup the 4,7,9,10,13,16 channels LIVE display screen.

5.5.1.5 Press Camera Select (1-16) directly to get the different camera full screen

5.5.2 Under LIVE display screen, press **LIVE +**  simultaneously, and press  **+** **or**  **-** to select the appointed **LIVE** display screen, and press Camera Select (1-16) to confirm the selected **LIVE** display camera.

Press  to exit.

5.5.3 The VCR video can be displayed with LIVE video simultaneously on multi-screen display mode.

5.5.3.1 Under LIVE display screen, press  **+**  simultaneously, and press  **+** **or**  **-** to select the appointed VCR display screen, and press Camera Select (1-16) to confirm the selected VCR display camera.

5.5.3.2 Press  to exit.

5.6 VCR





5.6.1 Press  button to setup all of the screen channels on the screen as VCR display. Then press the below button for desirable screen modes display.

5.6.1.1 Press  to setup the 4 channels VCR display screen.

5.6.1.2 Press  to setup the 9 channels VCR display screen.



5.6.1.3 Press  to setup the 16 channels VCR display screen.

5.6.1.4 Press  +4,7,9,10,13,16 : to setup the 4,7,9,10,13,16 channels VCR display screen.

5.6.2 Under VCR display screen, press  **+**  simultaneously, and press  **+** **or**  **-** to select the appointed VCR display screen, and press Camera Select (1-16) to confirm the selected VCR display camera.

Press  to exit.





5.6.3 The LIVE video can be displayed with VCR video simultaneously on multi-screen display.

5.6.3.1 Under VCR display screen, press **LIVE +**  simultaneously, and press  **+** **or**  **-** to select the appointed LIVE display screen, and press Camera Select (1-16) to confirm the selected LIVE display camera.

5.6.3.2 Press  to exit.

5.7 ZOOM

Press  button to enlarge the main monitor picture display. It displays 2 x 2 zoom picture on main picture and a small window insert. The insert window contains a movable 1/4 sized view of the appointed camera.

5.7.1 Press the ", ,  and  arrow buttons to move the zoom pointer. The multiplexer moves the 2 x 2 display accordingly.

5.7.2 Press Camera Select (1-16) to select the appointed camera LIVE display in ZOOM mode.

5.7.3 Press Camera Select (1-16) then press  +  simultaneously to select the appointed camera VCR display in ZOOM mode.

5.7.4 Press  to exit.





5.8 Picture in Picture (PIP)

Press PIP  button to enter PIP display screen. The PIP format displays a full screen "background" picture with a 1/16 size screen "insert".



5.8.1 Press  button to display the last selected PIP mode.

5.8.2 Press the , ,  and  arrow buttons to move the insert screen.

5.8.3 The LIVE video can be displayed with VCR video simultaneously in PIP mode.

5.8.3.1 Press  +  simultaneously then press the  + **or**  button to select VCR display on full screen or insert screen, and press Camera Select (1-16) to select the appointed camera.

5.8.3.2 Press  to exit.

5.8.3.3 Press **LIVE** +  simultaneously then press the  + **or**  button to select LIVE display on full screen or insert screen, and press Camera Select (1-16) to select the appointed camera.

5.8.3.4 Press  to exit

5.9 Left arrow (2x2)

5.9.1 4 channels display mode

- 5.9.2 To move leftward in on-screen menu after enter main item selection
- 5.9.3 To select system setup in on-screen menu after enter main item selection



5.10 **Right arrow (3x3)**

- 5.10.1 9 channels display mode
- 5.10.2 To move rightward in on-screen menu after enter main item selection
- 5.10.3 To select system setup in on-screen menu after enter main item selection

5.11 **Up arrow (4x4)**

- 5.11.1 16 channels display mode
- 5.11.2 To move upward in on-screen menu for main item selection
- 5.11.3 To select system setup after enter main item selection

5.12 **down arrow**

- 5.12.1 Multi-screen display select mode. **After pressing , the LED of selectable button will lighten.** Continue to press the button for desirable screen modes display. (If no selection will be made, press  again to exit selection)
 - 5.12.1.1 Press "4": 4 channels display mode
 - 5.12.1.2 Press "7": 7 channels display mode
 - 5.12.1.3 Press "9": 9 channels display model
 - 5.12.1.4 Press "10": 10 channels display mode
 - 5.12.1.5 Press "13": 13 channels display mode
 - 5.12.1.6 Press "16": 16 channels display mode
- 5.12.2 To move downward in on-screen menu for main item selection
- 5.12.3 To select system setup after enter main item selection

5.13 **Camera Select (1-16)**

- 5.13.1 Press the **Camera Select (1-16)** to select appointed camera to display on full screen mode.

6. Back Panel Connection

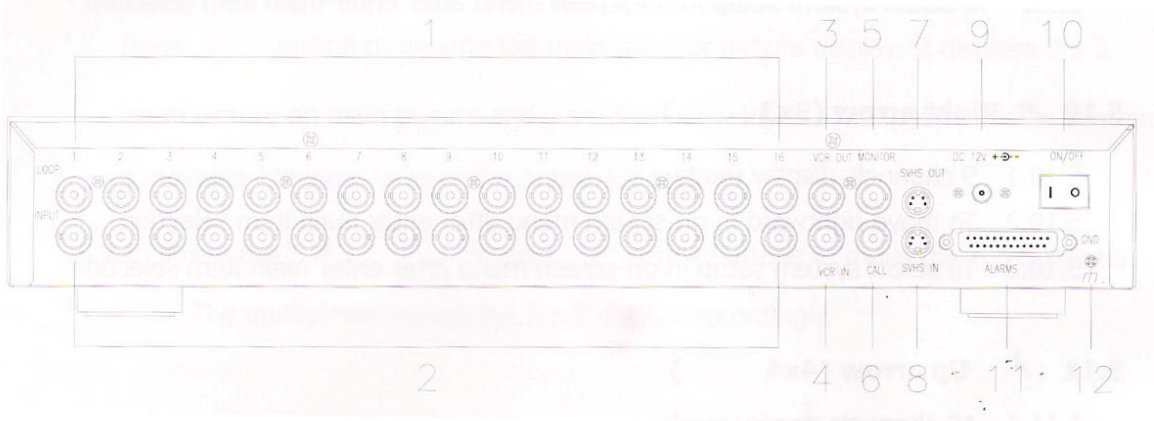

6.1 Loop

Connect video signal between Input port and Loop port to make a loop.
Connect up to 16 cameras

6.2 Camera Input: Connect up to 16 cameras.

6.3 VCR Out: Connect this output port to the VCR input port.

6.4 VCR In: Connect this input port to the VCR output port.

6.5 Monitor: Main monitor – live display/VCR playback display

6.6 Call: Call monitor out – auto switch channel

6.7 SVHS Out: Connect this output port to SVHS input of VCR

6.8 SVHS In: Connect this input port to SVHS output of VCR

6.9 Power Input: This is to connect DC12V, 1.25A power source

6.10 On/Off

On: power on

Off: power off

6.11 Alarm Connector

6.11.1 25 pin com port

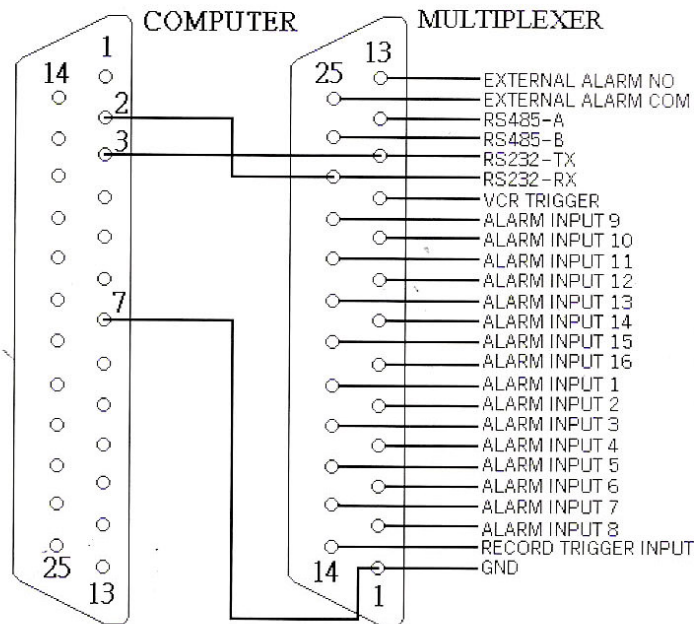

6.11.2 9 pin com port

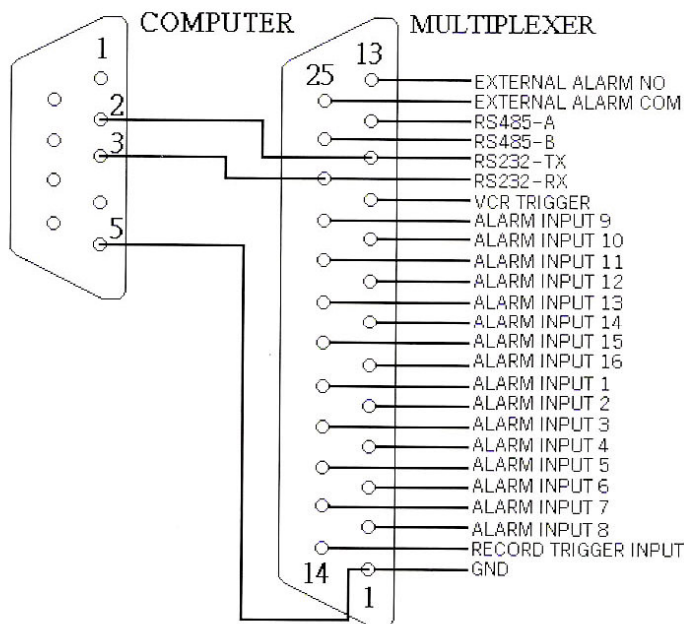

6.12 GND (Ground)

7. MENU SETTING



Press  +  simultaneously to enter the menu system setup, shown as **Figure 1**
(Menu will always display on Main monitor):

Figure 1 System Setup

▶ TITLE DISPLAY	ON	OFF
ALARM DURATION	02 SECOND	
DWELL TIME	02 SEC	
VCR RECORD TIME	002 HOUR	
ALARM VCR RECORD TIME	002 HOUR	
INT AUDIBLE ALARM	ON	OFF
EXT AUDIBLE ALARM	ON	OFF
EVENT MESSAGE LATCH	ON	OFF
SECURITY LOCK	ON	OFF
SET TIME	00/01/01	00:00:00 Y/M/D
EVENT LIST		
BAUD RATE	9600 BPS	
ID	000	
REMOTE INTERFACE	RS485	RS232C
SYSTEM RESET		

7.1  +  (on-screen menu will auto jump out to normal screen after 60 seconds of no action)

7.1.1 Press  +  simultaneously to enter the menu system setup

7.1.2 Press  or  to move arrow up and down for main item selection.







7.1.3 Press  to confirm selection.

7.1.4 **Press**  to confirm and return to main item selection

7.1.5 Press  to exit on-screen menu.









7.2 TITLE DISPLAY

7.2.1 Press  +  simultaneously to enter the menu system setup

- 7.2.2 Press  to move arrow down to TITLE DISPLAY
- 7.2.3 Press  to enter system setup of TITLE DISPLAY
- 7.2.4 Press  **or**  to set internal alarm **ON or OFF**
- 7.2.5 Press  to confirm and return to main item selection.
- 7.2.6 Press  to exit on-screen menu.









7.3 ALARM DURATION

It allows you to set the minimum multiplexer alarm time. The ALARM DURATION setting determines how many seconds or minutes the multiplexer remains in the alarm state after an alarm event occurs.

- 7.3.1 Press  +  simultaneously to enter the menu system setup
- 7.3.2 Press  to move arrow down to ALARM DURATION
- 7.3.3 Press  to enter system setup of ALARM DURATION.
- 7.3.4 Press  + **or**  to set alarm duration time when alarm is activated.
 - 7.3.4.1 Setting **1 ~ 59 seconds** and **1 ~ 30 minutes**
- 7.3.5 Press  to confirm and return to main item selection
- 7.3.6 Press  to exit on-screen menu.

7.4 DWELL TIME

The DWELL TIME setting determines the rate at which the multiplexer sequences the cameras on the monitor.

- 7.4.1 Press  +  simultaneously to enter the menu system setup
- 7.4.2 Press  to move arrow down to DWELL TIME.
- 7.4.3 Press  to enter system setup of DWELL TIME.
- 7.4.4 Press the  + **or**  button to setup the duration time for auto switch channel
in auto switch display screen: **1~10** seconds.
- 7.4.5 Press  to confirm and return to main item selection
- 7.4.6 Press  to exit on-screen menu.

7.5 VCR RECORD TIME: it allows you to enter the VCR's normal recording speeds.

7.4.2 Press  +  simultaneously to enter the menu system setup

7.4.3 Press  to move arrow down to VCR RECORD TIME.

7.4.4 Press  to confirm selecting VCR RECORD TIME.

7.4.5 Press  +  or  -  to select recording period

In NTSC system: selection of recording hours : 002H · 006H · 008H · 012H · 015H · 016H · 018H · 020H · 024H · 036H · 040H · 048H · 060H · 072H · 080H · 084H · 120H · 160H · 168H · 240H · 360H · 480H · 720H · 960H

In PAL system: selection of recording hours : 003H · 006H · 012H · 015H · 018H · 024H · 030H · 036H · 048H · 060H · 072H · 090H · 120H · 168H · 240H · 480H · 720H · 960H

7.4.6 Press  to confirm and return to main item selection

7.4.7 Press  to exit on-screen menu.





7.6 ALARM VCR RECORD TIME:

It allows you to enter the VCR's alarm recording speeds.

7.6.1 Press  +  simultaneously to enter the menu system setup

7.6.2 Press  to move arrow down to ALARM VCR RECORD TIME.

7.6.3 Press  to confirm selecting ALARM VCR RECORD TIME.*

7.6.4 Press  +  or  -  to select recording period









In NTSC system: selection of recording hours : 002H · 006H · 008H · 012H · 015H · 016H · 018H · 020H · 024H · 036H · 040H · 048H · 060H · 072H · 080H · 084H · 120H · 160H · 168H · 240H · 360H · 480H · 720H · 960H

In PAL system: selection of recording hours : 003H · 006H · 012H · 015H · 018H · 024H · 030H · 036H · 048H · 060H · 072H · 090H · 120H · 168H · 240H · 480H · 720H · 960H









7.6.5 Press  to confirm and return to main item selection

7.6.6 Press  to exit on-screen menu.



7.7 INT AUDIBLE ALARM: to set up internal alarm







- 7.7.1 Press  +  simultaneously to enter the menu system setup
- 7.7.2 Press  to move arrow down to INT AUDIBLE ALARM.
- 7.7.3 Press  to enter system setup of INT AUDIBLE ALARM.
- 7.7.4 Press  **or**  to set internal alarm **ON or OFF**
 - 7.7.4.1 Select ON: the buzzer will be activated
 - 7.7.4.2 Select OFF: the buzzer will not be activated
- 7.7.5 Press  to confirm and return to main item selection.
- 7.7.6 Press  to exit on-screen menu.

7.8 EXT AUDIBLE ALARM: to set up external alarm



- 7.8.1 Press  +  simultaneously to enter the menu system setup
- 7.8.2 Press  to move arrow down to EXT AUDIBLE ALARM.
- 7.8.3 Press  to enter system setup of EXT AUDIBLE ALARM.
- 7.8.4 Press  **or**  to set external alarm **ON or OFF**
- 7.8.5 Press  to confirm and return to main item selection.
- 7.8.6 Press  to exit on-screen menu.

7.9 EVENT MESSAGE LATCH

It controls the way the External Alarm  or Video Loss  graphic is displayed on monitor screen.

- 7.9.1 Press  +  simultaneously to enter the menu system setup
- 7.9.2 Press  to move arrow down to EVENT MESSAGE LATCH.
- 7.9.3 Press  to enter system setup of EVENT MESSAGE LATCH
- 7.9.4 Press  **or**  to set external alarm **ON or OFF**

ON: The monitor screen displays the External Alarm  or Video Loss  graphic on the monitor and the LED of Camera Select (1-16) button will flash.

OFF: The External Alarm  or Video Loss  graphic is displayed on the monitor only when the alarm is activated only.

7.9.5 Press  to confirm and return to main item selection.

7.9.6 Press  to exit on-screen menu.



7.10 SECURITY LOCK



It controls the multiplexer front panel security lock feature. When this feature is on, the multiplexer locks all front panel buttons except those required to re-enter the setup mode.

7.10.1 Press  +  simultaneously to enter the menu system setup

7.10.2 Press  to move arrow down to SECURITY LOCK.

7.10.3 Press  to enter system setup of SECURITY LOCK

7.10.4 Press  **or**  to set external alarm **ON** (show  on the bottom side of time) or **OFF**

ON : all front panel button will be locked and only can be released
by press  +  to setup MENU again.

OFF : no security lock feature.

7.10.5 Press  to confirm and return to main item selection.

7.10.6 Press  to exit on-screen menu.

7.11 SET TIME: to set up date and time

7.11.1 Press  +  simultaneously to enter the menu system setup

7.11.2 Press  to move arrow down to SET TIME.

7.11.3 Press  to enter system setup of SET TIME.



7.11.4 Press  **or**  to select time display method as below



7.11.4.1 00/01/01 00:00:00 (Year/Month/Day Hour: Minute: Second)

7.11.4.2 00/01/01 00:00:00 (Day/Month/Year Hour: Minute: Second)

7.11.4.3 01/00/01 00:00:00 (Month/Day/Year Hour: Minute: Second)

7.11.4.4 **Time Display Off:** No timing display on screen









7.11.5 Press  + **or**  to set current time

7.11.6 Press  **or**  to move left or right for setting time

7.11.7 Press  to confirm and return to main item selection.









7.11.8 Press  to exit on-screen menu.

7.12 EVENT LIST: to check the record of video loss or alarm status









- 7.12.1 Press  +  simultaneously to enter the menu system setup
- 7.12.2 Press  to move arrow down to EVENT LIST.
- 7.12.3 Press  to enter system setup of EVENT LIST.
- 7.12.4 Press  **or**  to set EVENT LIST
- 7.12.5 Press  to confirm and return to main item selection
- 7.12.6 Press  to exit on-screen menu.

---15 VLOSS 01/15/31 13:13:12
--- 8 ALARM 01/10/31 13:13:12

7.13 BAUD RATE: to set up remote control baud rate





- 7.13.1 Press  +  simultaneously to enter the menu system setup
- 7.13.2 Press  to move arrow down to REMOTE CONTROL BAUD RATE.
- 7.13.3 Press  to enter system setup of REMOTE CONTROL BAUD RATE.
- 7.13.4 Press  + **or**  to setup the Baud Rate (bps) for : 115200 、 57600 、 19200 、 9600 、 4800 、 3600 、 2400 、 1200.
- 7.13.5 Press  to confirm and return to main item selection
- 7.13.6 Press  to exit on-screen menu.

7.14 ID

- 7.14.1 Press  +  simultaneously to enter the menu system setup
- 7.14.2 Press  to move arrow down to ID.
- 7.14.3 Press  to enter system setup of ID.
- 7.14.4 Press  + **or**  to setup the ID number: **000~063**.
- 7.14.5 Press  to confirm and return to main item selection.
- 7.14.6 Press  to exit on-screen menu.

7.15 REMOTE INTERFACE : RS485 and RS232C can be selected for remote control interface.



7.16 SYSTEM RESET

- 7.16.1 Press  +  simultaneously to enter the menu system setup
- 7.16.2 Press  to move arrow down to SYSTEM RESET.
- 7.16.3 Press  to enter SYSTEM RESET.
- 7.16.4 Press  to exit on-screen menu.

8. CHANNEL SETUP

Press \leftarrow + \blacktriangle simultaneously to enter the menu set up, as shown in **Figure 1**, then press \swarrow + to enter channel setup, as shown in **Figure 2** (Menu will always display on Main monitor), Press \swarrow - to return to previous system setup.

Figure 2 **CHANNEL SETUP**

	TITLE	DWELL				ALARM	RECORD
▶	---- 01	ON	05	05	05	LOW	EVENT
	---- 02	ON	05	05	05	LOW	EVENT
	---- 03	ON	05	05	05	LOW	EVENT
	---- 04	ON	05	05	05	LOW	EVENT
	---- 05	ON	05	05	05	LOW	EVENT
	---- 06	ON	05	05	05	LOW	EVENT
	---- 07	ON	05	05	05	LOW	EVENT
	---- 08	ON	05	05	05	LOW	EVENT
	---- 09	ON	05	05	05	LOW	EVENT
	---- 10	ON	05	05	05	LOW	EVENT
	---- 11	ON	05	05	05	LOW	EVENT
	---- 12	ON	05	05	05	LOW	EVENT
	---- 13	ON	05	05	05	LOW	EVENT
	---- 14	ON	05	05	05	LOW	EVENT
	---- 15	ON	05	05	05	LOW	EVENT
	---- 16	ON	05	05	05	LOW	EVENT

8.1 TITLE

It allows you to assign a title to each camera input. Initially each title is the camera's number.

8.1.1 Press \blacktriangle or \blacktriangledown : Select channel in the Channel setup

8.1.2 Press \leftarrow : Confirm the channel









8.1.3 Press \swarrow or \searrow : Select the location of title (6 characters maximum)

8.1.4 Press \swarrow + or \swarrow - : Select the characters for display (**0~9, A~Z**)









8.1.5 Press \blacktriangle : Confirm and exit the title setting

8.1.6 Press \blacktriangle : Exit the channel setup









8.2 **DWELL:** to set up auto switching channel

- 8.2.1 Press  **or**  : Select channel in the Channel setup
- 8.2.2 Press  : Enter the channel setup
- 8.2.3 Press  **or**  : Select DWELL on the screen
- 8.2.4 Press  **or**  : Select ON/OFF on the screen
- 8.2.5 Press  : Confirm and exit the dwell setting
- 8.2.6 Press  : Exit the channel setup





8.3 (**Brightness**) / (**Contrast**) / (**Color**): video adjustment of each channel

- 8.3.1 Press  **or**  : Select channel in the Channel setup
- 8.3.2 Press  : Enter the channel setup
- 8.3.3 Press  **or**  : Select brightness/contrast/color on the screen
- 8.3.4 Press  **or**  : Set up **0~9** on the screen.
- 8.3.5 Press  : Confirm and exit the brightness/contrast/color setting.
- 8.3.6 Press  : Exit the channel setup

8.4 **ALARM**

- 8.4.1 Press  **or**  : Select channel in the Channel setup
- 8.4.2 Press  : Enter the channel setup
- 8.4.3 Press  **or**  : Select Warn on the screen
- 8.4.4 Press  **or**  : Select LOW/OFF/HIGH for alarm polarity
- 8.4.5 Press  : Confirm and exit the alarm setting.
- 8.4.6 Press  : Exit the channel setup

8.5 **RECORD**

- 8.5.1 Press  **or**  : Select channel in the Channel setup
- 8.5.2 Press  : Enter the channel setup
- 8.5.3 Press  **or**  : Select Record on the screen.

8.5.4 Press  +  or  -  : Select VCR record method as below (VCR will only record the channel which has been set up for **EVENT/NORMAL/OFF**)

8.5.4.1 **EVENT:** when alarm input is triggered, VCR will record alarming channel more frequently. For example : VCR normal record method is 1-2-3-4-5-.....-16. In Event mode, when CH01 is triggered, the record method will become 1-2-1-3-1-4-1-5-...-16.





8.5.4.2 **NORMAL:** when external alarm is on, VCR will record normally as set up.





8.5.4.3 **OFF:** VCR will not record

8.5.5 Press  : Confirm and exit the record setting

8.5.6 Press  : Exit the channel setup

9. MOTION DETECTION SETUP

9.1 Press  +  simultaneously to enter the menu set up, as shown in **Figure 1**, then press  +  to enter channel setup, as shown in **Figure 2** (Menu will always display on Main monitor).

9.2 To access the motion setup screen, press  then press **Motion** while the Camera title menu is displayed. Each screen displays the current camera picture overlaid with the motion targets (as shown in Figure 3). You can move the arrows  or   or  to adjust whether motion detection is **ON** or **OFF**.

9.3 The targets on each motion setup can be turned ON or OFF individually, by row or by screen. To set up targets, use the following front panel buttons:

9.3.1 Press  to confirm the channel

9.3.2 Press **"MOTION"** to enter motion mode

9.3.3  **Up arrow** -- moves the target cursor up one row at a time.

9.3.4  **Down arrow** -- moves the target cursor down one row at a time.

9.3.5  **Left arrow** -- moves the target cursor left one column at a time.

9.3.6  **Right arrow** -- moves the target cursor right one column at a time.

9.3.7 Press **"MOTION"** to turn the target cursor ON

Press **"MOTION"** again to turn the target cursor OFF

9.3.8 **Camera Select (1-16)** -- toggles the corresponding target on the cursor line ON or OFF. (as shown in Figure 3-1) There are only 15 targets in one row,

therefore only Camera Select (1-15) can be operated.

9.3.9 **Line** – turns all targets in the current row ON or OFF. (shown as Figure 3-2)

9.3.10 **All** – turns all targets on the screen ON or OFF. (shown as Figure 3-3)

9.4 To adjust $\swarrow +$ or $\searrow -$ button to setup the Sensitivity list **000~255**

Sensitivity value is sensitive with motion and brightness change.

Low value (as 001) means higher sensitivity on motion and brightness change.

High value (as 255) means lower sensitivity on motion and brightness change.

User can choose the suitable sensitivity value in different location. The default value is set on 32.

Figure 3 **MOTION DETECTION SETUP**

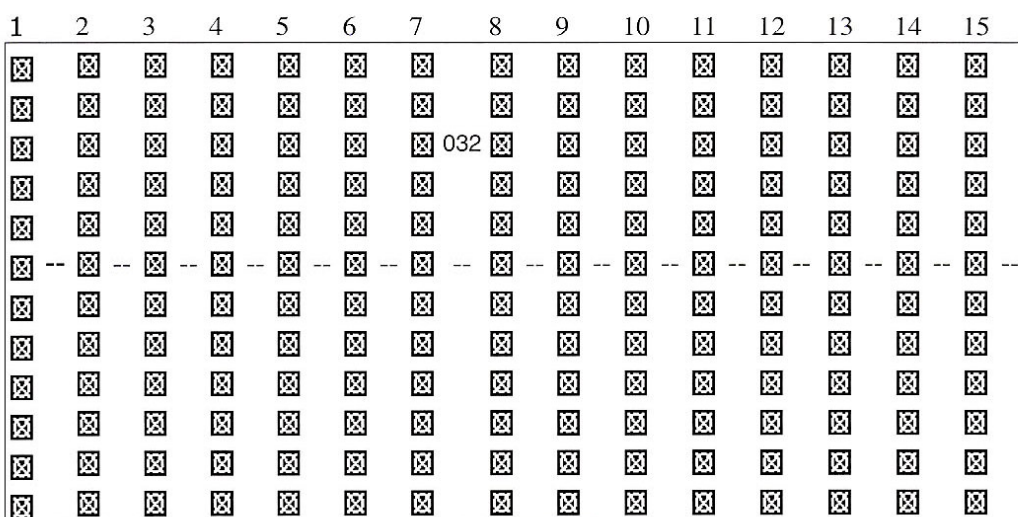

Figure 3-1 **MOTION DETECTION SETUP – 1~16**

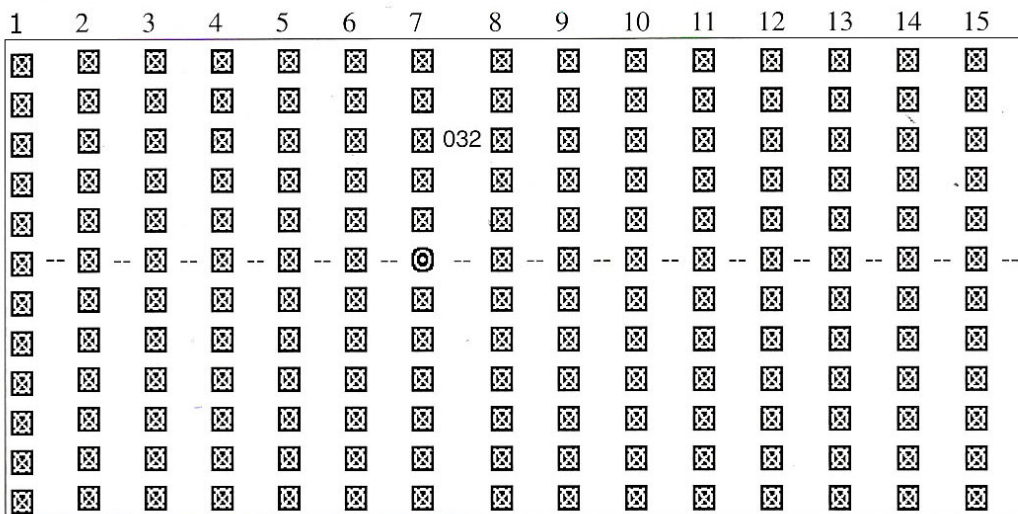

Figure 3-2 **MOTION DETECTION SETUP – LINE**

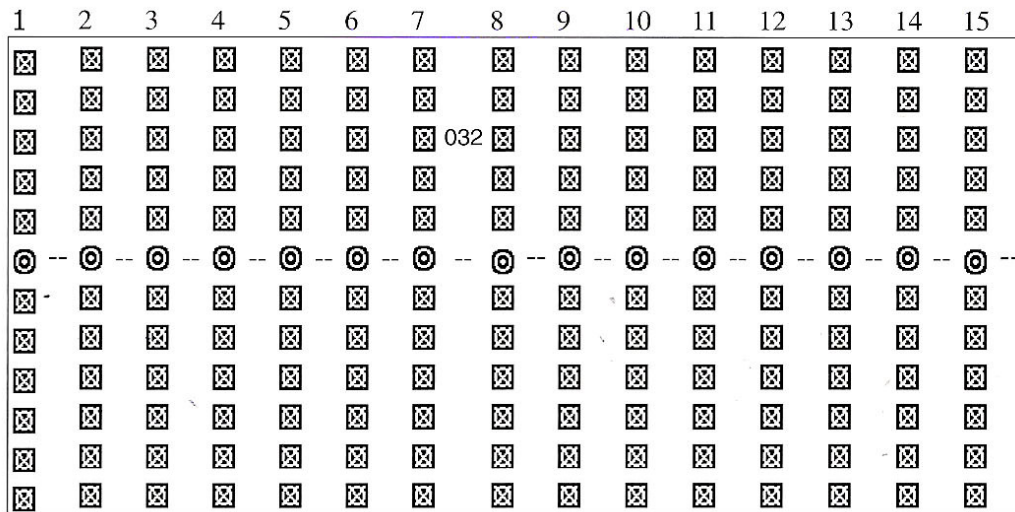
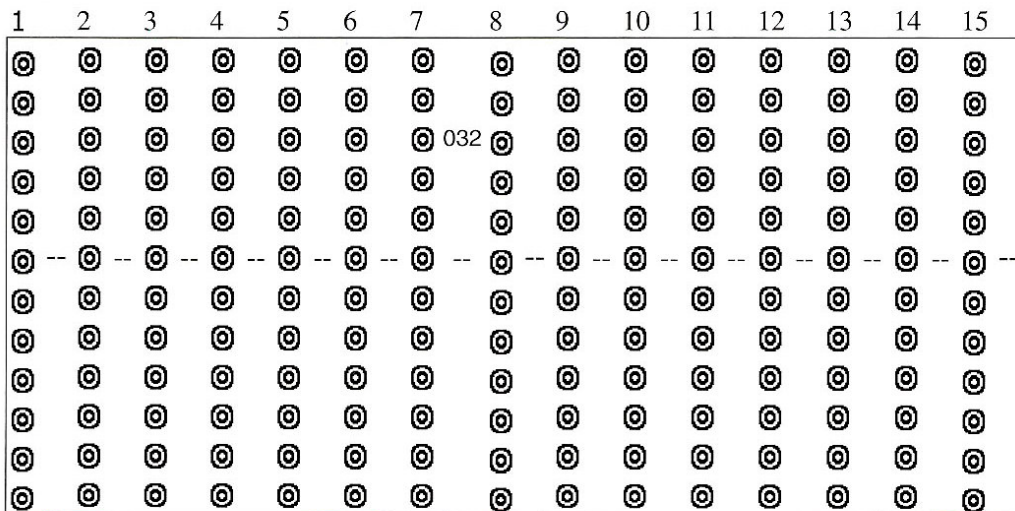

Figure 3-3 **MOTION DETECTION SETUP – ALL**



10. Monitor Operation

10.1 To connect with one monitor :

Please connect with MONITOR connector.

10.2 To connect with two monitors:

One monitor connect to "MONITOR" connector and show live display / VCR playback. The other monitor connects to "CALL" connector to show "auto switch" and "alarming channel" display.

10.3 Call Monitor display:

10.3.1 Call Monitor will switch 16 channels automatically in general.

10.3.2 The alarming channel will display full screen on the call monitor. While there are more than 2 channel alarms are activated at the same time, the call monitor will auto switch to display for the above 2 channels in turns in full screen only.

11. Auto Switching

The multiplexer allows cameras to display sequentially on the main monitor in various available format. In the full screen format, all cameras can be displayed sequentially full screen. In multi-screen formats, cameras which are not displayed on screen can be display sequentially in the lower right window or in the confirmed window.

11. Auto switching:

To select the desired format (Full Screen, or  or  or  or

 or  or )

11.1 Auto switching of Full screen

11.1.1 The monitor screen under full screen display

11.1.2 Press  button to start auto switching

11.1.3 Press  button to stop auto switching

11.2 Auto switching of 4, 7, 9, 10, 13, 16 channels display mode

   

11.2.1 The monitor screen under the above display mode.

11.2.2 Press  button to start auto switching.

At the lower-right window of the display screen, the auto switching displays only the channels which do not display on the monitor screen.

11.2.3 Press  button to stop auto switching

11.2.4 Press  + Camera Select (1-16) to start the auto switching at the appointed window. The appointed window means the window location (in the sequential order from left to right and top to bottom) displayed on monitor screen. It only displays the auto switching of the channels which do not display on monitor screen.

11.3 Auto switching of ZOOM mode

11.3.1 The monitor screen under the ZOOM display mode

11.3.2 Press  button to start auto switching

11.3.3 Press  button to stop auto switching

11.4 Auto switching of PIP mode

11.4.1 The monitor screen under the PIP display mode



11.4.2 Press  button to start auto switching of the small insert window

11.4.3 Press  button to stop auto switching

11.4.4. Press  + Camera channel # on main screen to start the auto switching on main screen. It only displays the auto switching of the channels which do not display on monitor screen.

11.5 Auto switching of QUAD DISPLAY mode →

11.5.1 The monitor screen under  mode

11.5.2 Press  +  button to start auto switching of QUAD DISPLAY mode

11.5.3 Press  button to stop auto switching

12.VCR Playback Operation

To review a videotape with the multiplexer, you need to press PLAY button of the VCR. The multiplexer decodes the recorder video signal and displays it in the current format, showing  on the bottom of the channel. Cameras appear in the order they were recorded. Multiplexer operation during videotape playback is the same as when viewing live cameras. All front panel buttons have the same effect. The difference is that VCR is the source of video. Please refer to section 5.6 for details of VCR playback operation

13. External Alarm Input and Video Loss Signal, when activated

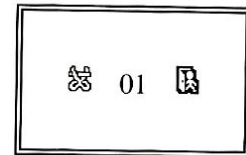

Live Display Screen

13.1 External alarm input

13.1.1 Live display screen: alarming channel will show  on the right of the channel title. If the alarming channel is not currently displayed on the screen, the monitor will jump to 16 channels display mode while alarm is activated.

13.1.2 Auto switch display screen: screen will display alarming channel. When there are more than 2 alarming channels occur, monitor will auto switch to show alarming channels in turns.

12.1.3 VCR RECORD time will auto reset to alarm VCR record time, and record more frequently for alarming channels.

13.2 Video loss

This multiplexer has 2 visual ways of letting you know when the video losses it's signal.

13.2.1  is shown on the left side of channel title. If the video loss channel is not currently display on the screen, the screen will jump to 16 channels display mode while video is activated.

14. VCR Time Setting

- 14.1 Multiplexer's VCR record time setting should be same as VCR record time setting. If Auto is used, multiplexer will automatically set it's own VCR time setting to be the same as VCR time setting.
- 14.2 **Auto setting:** If VCR has "VCR Trigger Out" control signal connected with multiplexer's record trigger input, multiplexer will auto detect the VCR timer setting. If not, Multiplexer will follow it's own original setting.
- 14.3 **Manual setting :** If VCR does not have "VCR Trigger Out" control signal, the multiplexer needs to set up VCR record time on the screen menu. Since different VCRs have different settings, please refer to Record Time Flash Rate Chart for reference.

15. Record Time Flash Rate Chart:

NTSC System:

Record Mode	VIDEO INPUT QUANTITY		
	1 CHANNEL (Picture/second)	4 CHANNEL (Picture/second)	16 CHANNEL (Picture/second)
002H	~ 15.000	~ 3.750	~ 0.938
006H	~ 10.000	~ 2.500	~ 0.625
008H	~ 7.500	~ 1.875	~ 0.469
012H	~ 5.000	~ 1.250	~ 0.313
015H	~ 4.000	~ 1.000	~ 0.250
016H	~ 3.750	~ 0.938	~ 0.235
018H	~ 3.333	~ 0.833	~ 0.208
020H	~ 3.000	~ 0.750	~ 0.188
024H	~ 2.500	~ 0.625	~ 0.156
036H	~ 1.667	~ 0.417	~ 0.104
040H	~ 1.500	~ 0.375	~ 0.094
048H	~ 1.250	~ 0.313	~ 0.078
060H	~ 1.000	~ 0.250	~ 0.063
072H	~ 0.833	~ 0.208	~ 0.052
080H	~ 0.750	~ 0.188	~ 0.047
084H	~ 0.667	~ 0.167	~ 0.042
120H	~ 0.500	~ 0.125	~ 0.031
160H	~ 0.375	~ 0.094	~ 0.024
168H	~ 0.333	~ 0.083	~ 0.021
240H	~ 0.250	~ 0.063	~ 0.016
360H	~ 0.167	~ 0.042	~ 0.011
480H	~ 0.125	~ 0.031	~ 0.008
720H	~ 0.083	~ 0.021	~ 0.005
960H	~ 0.063	~ 0.013	~ 0.003

PAL System:

RECORD MODE	VIDEO INPUT QUANTITY		
	1 CHANNEL	4 CHANNEL	16 CHANNEL
003H	~ 12.500	~ 3.125	~ 0.781
006H	~ 8.333	~ 2.081	~ 0.520
012H	~ 6.250	~ 1.563	~ 0.391
015H	~ 5.000	~ 1.250	~ 0.313
018H	~ 4.167	~ 1.042	~ 0.261
024H	~ 3.125	~ 0.781	~ 0.195
030H	~ 2.500	~ 0.625	~ 0.156
036H	~ 2.083	~ 0.521	~ 0.130
048H	~ 1.563	~ 0.391	~ 0.098
060H	~ 1.250	~ 0.313	~ 0.078
072H	~ 1.042	~ 0.261	~ 0.065
090H	~ 0.833	~ 0.208	~ 0.052
120H	~ 0.625	~ 0.156	~ 0.039
168H	~ 0.417	~ 0.104	~ 0.026
240H	~ 0.313	~ 0.078	~ 0.020
480H	~ 0.156	~ 0.039	~ 0.010
720H	~ 0.104	~ 0.026	~ 0.007
960H	~ 0.078	~ 0.020	~ 0.005

16. Remote Control Function

DATA: 1 Start bit ,8bit data ,none,1 Stop bit

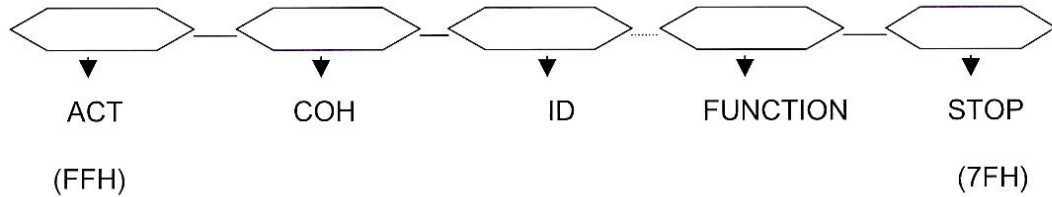

FUNCTION	CODE	ASCII	FUNCTION	CODE	ASCII
MENU	0x4D	M	11	0x42	B
ESC	0x1B	ESC	12	0x43	C
FREEZE	0x5A	Z	13	0x44	D
LIVE	0x49	I	14	0x45	E
VCR	0x56	V	15	0x46	F
ZOOM	0x7A	z	16	0x47	G
PIP	0x50	P	ENTER	0x0D	ENTER
LEFT	0x4C	L	SEQUENCE 1	0x61	a
RIGHT	0x52	R	SEQUENCE 2	0x62	b
UP	0x55	U	SEQUENCE 3	0x63	c
DOWN	0x4E	N	SEQUENCE 4	0x64	d
KEY_LOCK	0x4B	K	SEQUENCE 5	0x65	e
1	0x31	1	SEQUENCE 6	0x66	f
2	0x32	2	SEQUENCE 7	0x67	g
3	0x33	3	SEQUENCE 8	0x68	h
4	0x34	4	SEQUENCE 9	0x69	i
5	0x35	5	SEQUENCE 10	0x6A	j
6	0x36	6	SEQUENCE 11	0x6B	k
7	0x37	7	SEQUENCE 12	0x6C	l
8	0x38	8	SEQUENCE 13	0x6D	m
9	0x39	9	SEQUENCE 14	0x6E	n
10	0x41	A	SEQUENCE 15	0x6F	o
			SEQUENCE 16	0x70	p

17. Connection:

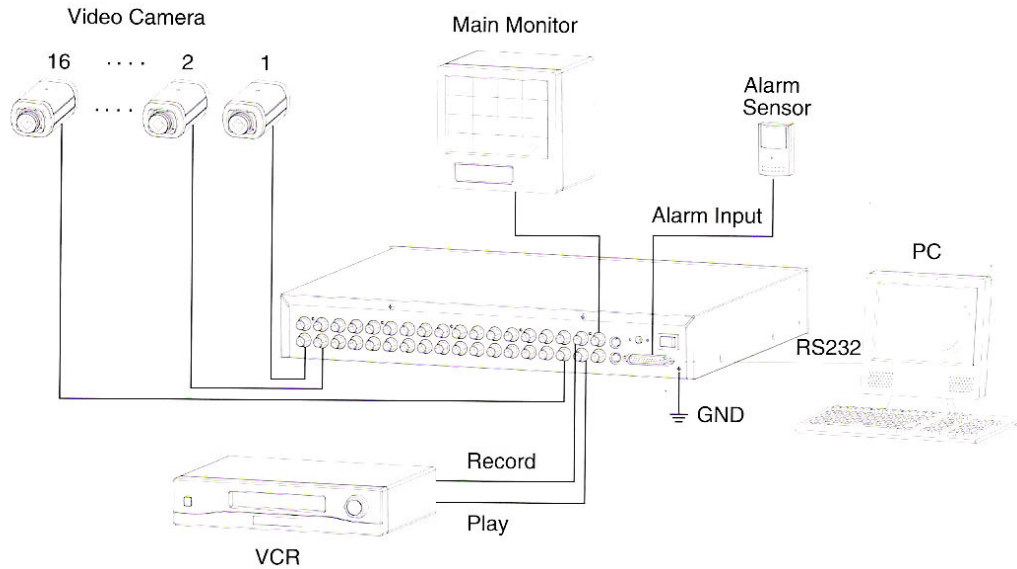

Basic Connection for Multiplexer – with 1 monitor

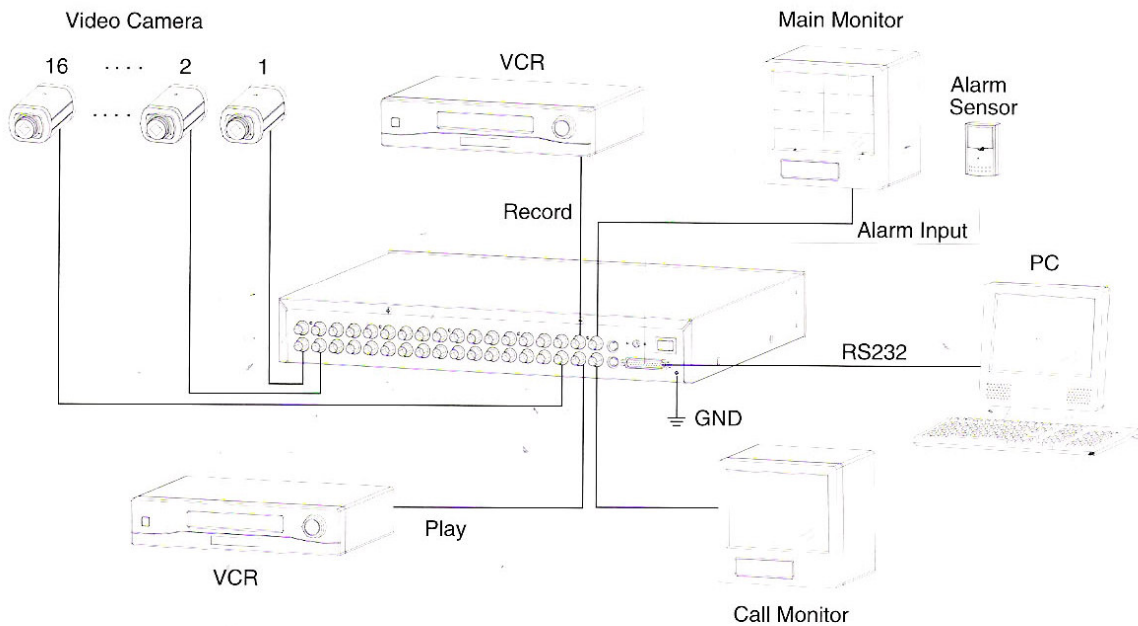

Full Duplex Connections for Multiplexer – with 2 monitors

18. Rack Mount Installation:

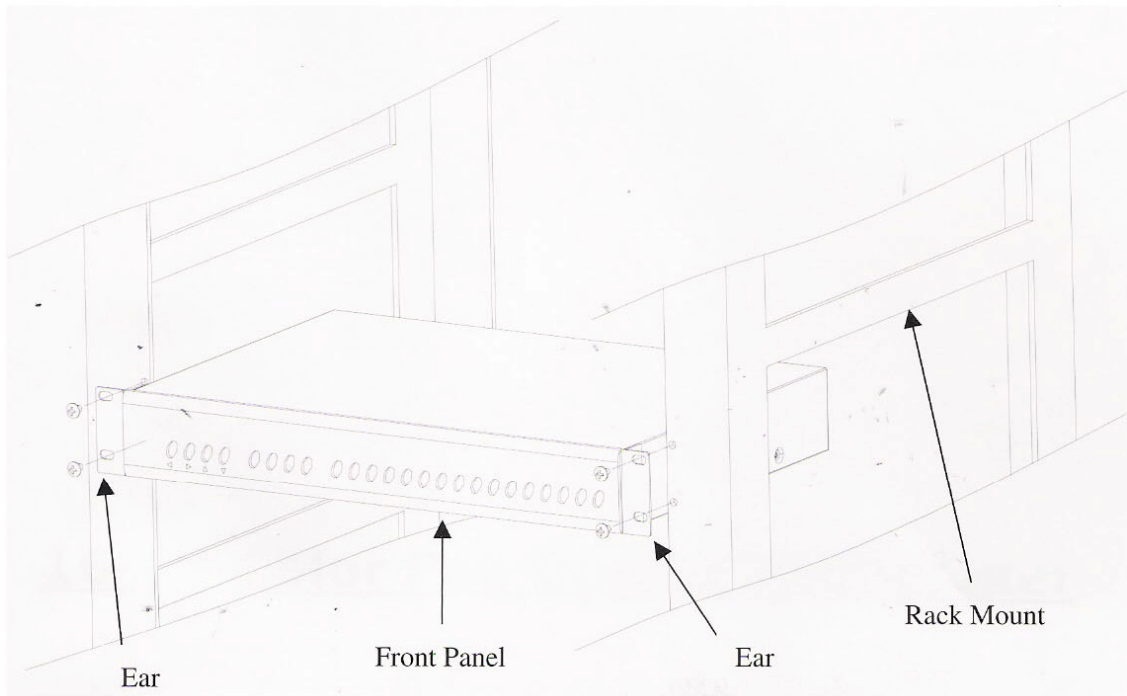

Front Angle with Rack Mount

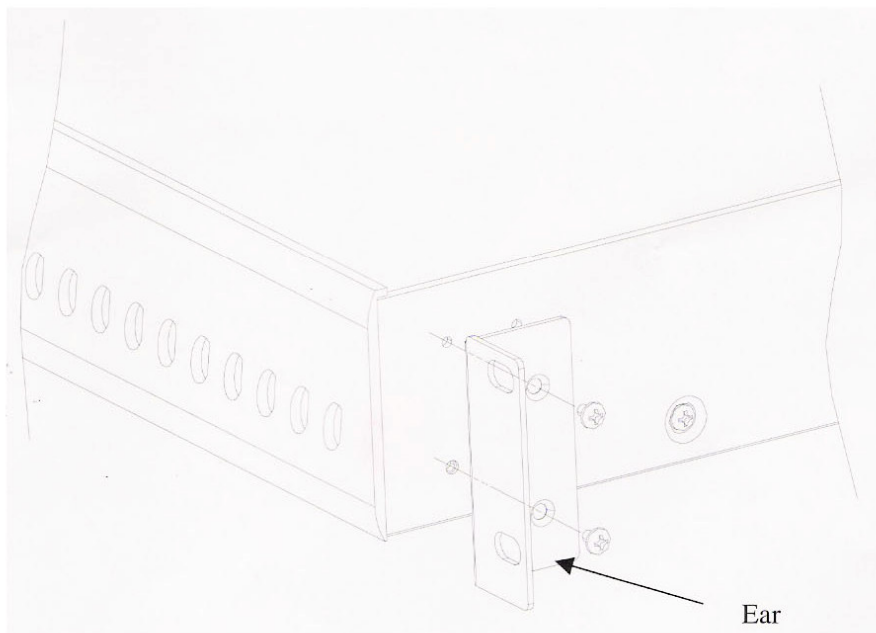

Side Angle View

Free Manuals Download Website

<http://myh66.com>

<http://usermanuals.us>

<http://www.somanuals.com>

<http://www.4manuals.cc>

<http://www.manual-lib.com>

<http://www.404manual.com>

<http://www.luxmanual.com>

<http://aubethermostatmanual.com>

Golf course search by state

<http://golfingnear.com>

Email search by domain

<http://emailbydomain.com>

Auto manuals search

<http://auto.somanuals.com>

TV manuals search

<http://tv.somanuals.com>