

# mace

---

## 1/3" Day & Night Color CCD Camera

Model : CAM91

Instruction Guide

---



---

**MACE Electronic Surveillance Products**

3233 SW 2nd Ave. Fort Lauderdale, FL 33315 USA  
toll-free(877)585-MACE  
local(954)585-6223 fax(954)585-6225  
[www.mace.com](http://www.mace.com)

---

MACE Electronic Surveillance Products

### ■ Warning

- TO REDUCE THE RISK OF FIRE OR ELECTRIC SHOCK, DO NOT EXPOSE THIS PRODUCT TO RAIN OR MOISTURE

### ■ Caution



### ■ Explanation of graphical symbols



The lightning flash with arrowhead symbol, within an equilateral triangle is intended to alert the user to the presence of uninsulated "dangerous voltage" within the product's enclosure that may be of sufficient magnitude to constitute a risk of electric shock to persons.



The exclamation point within an equilateral triangle is intended to alert the user to the presence of important operating and maintenance (servicing) instruction in the literature accompanying the product.

## ■ Features

### • Day&Night

The camera provides automatic mode changeover by sensing day or night conditions. It can change color mode in the day condition for optimal color and BW mode in night condition for clear identification.

### • High Resolution

The horizontal resolution of 480TV lines at color mode and 520TV lines at BW mode can be achieved by using a high density Sony CCD (410K pixels), which provides clean, noiseless and reliable pictures.

### • Motion Detection

The camera transmits an alert signal to the REMOTE jack when it detects motion of an object. If you connect an optional alarm to the camera, you can get the effective surveillance. This allows multi observation through several monitors efficiently.

### • Controlled by OSD menu and RS-232C

You can control the camera using OSD menu and RS-232 jack at a remote place.

### • Video/DC Lens Selectable

The camera accepts 2 types of auto iris lens (DC type/VIDEO type) and is set with the DC/VIDEO selection switch.

### • Line-Lock Selectable

You can select the Sync. system on OSD.

### • BLC Function

When the image is in front of strong background lighting, your camera allows you to get the clear image.

## ■ Warning

### 1. The camera needs periodic inspection.

Contact an authorized technician for inspection.

### 2. Stop using your camera when you find a malfunction

If you use your camera around smoke or unusual heat for a long time, a fire may be caused.

### 3. Do not install the camera on a surface that can not support it.

Unless the surface is suitable, it could cause falling or other hazards.

### 4. Do not hold plug with wet hands.

It could cause an electric shock.

### 5. Do not disassemble the camera.

It may result in fire, electric shock or other hazards.

### 6. Do not use the camera close to a gas or oil leak.

It may result in fire or other hazards.

## ■ Precautions

**Do not install the camera in extreme temperature conditions.**

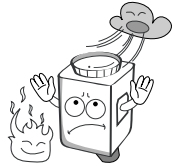

Only use the camera under conditions where temperatures are between  $-10^{\circ}$  and  $50^{\circ}$ . Be especially careful to provide ventilation when operating under high temperatures.

**Do not drop the camera or subject them to physical shocks.**



It can cause malfunctions to occur.

**Do not install the camera under unstable lighting conditions**

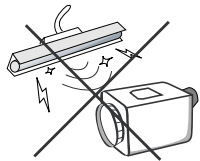

Severe lighting change or flicker can cause the camera to work improperly.

**Never keep the camera face to strong light directly.**

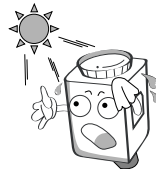

It can damage the CCD.

**Do not touch the front lens of the camera.**



It is one of the most important parts of the camera. Be careful not to be stained by fingerprint.

**Do not expose the camera to rain or spill beverage on it.**



If it gets wet, wipe it dry immediately. Liquids can contain minerals that corrode the electronic components.

**■ Contents**

**Name and Function of Each Part**

- Front ..... 10
- Bottom ..... 11
- Back ..... 12
- Accessories ..... 13

**Installation Method**

- Lens ..... 14
- Installing Auto Iris Lens ..... 14
- Installing C/CS Mount Lens ..... 16
- Mounting a CS-Mount Lens ..... 16
- Mounting a C-Mount Lens ..... 16
- Connecting to Monitor ..... 17
- Connecting to Power ..... 17

**Operating Your Camera**

- Configuration of The Menu ..... 18
- Setting Up The Menu ..... 19
  - Camera ID ..... 20
  - Back Light Compensation ..... 22
  - Lens Selection ..... 23

- Shutter Speed Control ..... 24
- Gain Control ..... 26
- White Balance Control ..... 27
- Motion Detection ..... 29
- Color(Day&night) ..... 31
- Synchronization Mode ..... 33
- Reset/End ..... 34

**Using Remote Jack ..... 35**

**External Connecting Terminal ..... 36**

**Specifications ..... 37**

**Troubleshooting ..... 38**

**Warranty ..... 39**

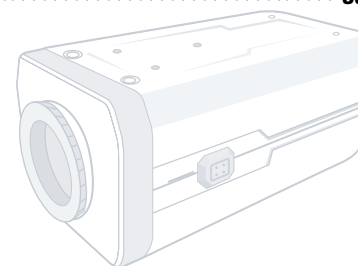

## ■ Name and Function of Each Part

### ● Front

#### C Mount Adaptor

Attach the C-Mount Adaptor when using the C-Mount Lens

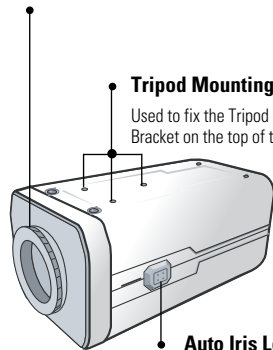

#### Tripod Mounting Bracket Screw Hole

Used to fix the Tripod mounting Bracket on the top of the camera

#### Auto Iris Lens Connector

Used to connect the auto iris lens plug

## ■ Name and Function of Each Part

### ● Bottom

#### Tripod Mounting Hole

Used to install the camera on an optional tripod  
The tripod must be equipped with the screw specified as below

- 1/4"-20UNC(20 THREAD)
- L : 4.5mm  $\pm$ 0.2mm(ISO standard) or 0.197"(ASA standard)

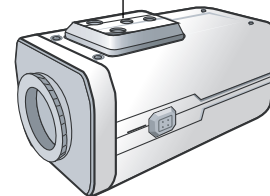

You can remove and install this bracket on the top of the camera. You must use the supplied screw or equivalent(within 4mm). If not, the bracket may not be fixed properly.

## ■ Name and Function of Each Part

### ● Back

#### ● Power LED

The LED turns on when power is supplied.

#### ● DC/VIDEO Selection Switch

Used to choose DC or VIDEO according to the type of your auto iris lens.

#### ● External Terminal

Used to connect external Day/Night input signal. This also provides the motion detect signal.

#### ● Video Out Jack

Used to connect an external video monitor in jack.

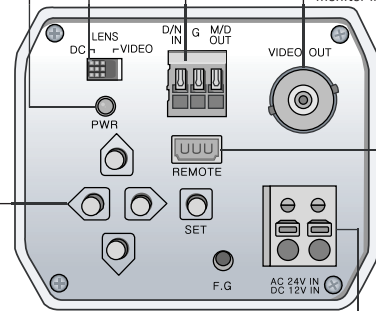

#### ● REMOTE Jack

#### ● Menu Setup Buttons

- Set Button  
Used to access menu mode. Also used to confirm the setting.
- Up/Down Button  
Used to choose the desired menu item. It also moves the cursor up or down in the menu screen.
- LEFT/RIGHT Button  
Used to change the parameter of the selected menu item. It also moves the cursor to the left or right in the menu screen.

#### ● Power Terminal

Used to connect AC24V or DC12V power source. (Non-Polarity)

## ■ Name and Function of Each Part

### ● Accessories

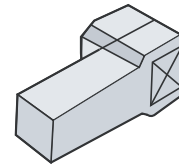

Auto Iris Lens Plug

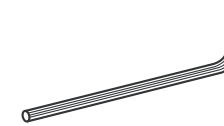

L-Wrench

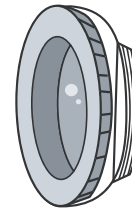

C-Mount Adaptor

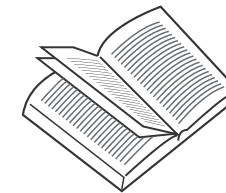

Instruction Manual

## ■ Installation Method

### ● Lens

The lens is not supplied with this camera. Purchase a lens suitable for your environment.

This camera accepts the auto iris lens and both C- and CS-mount lens.

### ● Installing Auto Iris Lens

1. Remove the cover from the iris lens plug supplied, and solder the lens cable to the plug as shown below.

Pin No.	Video type	DC type
No.1 Pin	Power(Red)	Damping-
No.2 Pin	N.C	Damping+
No.3 Pin	Video signal(White)	Drive+
No.4 Pin	GND(Black)	Drive-

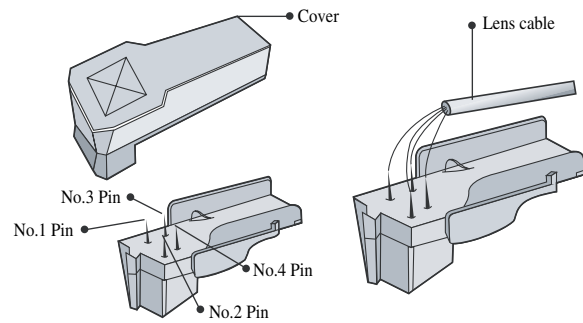

2. Attach the lens to the camera by turning clockwise.

## ■ Installation Method

3. Connect the lens plug to the auto iris connector on the right side of the camera.

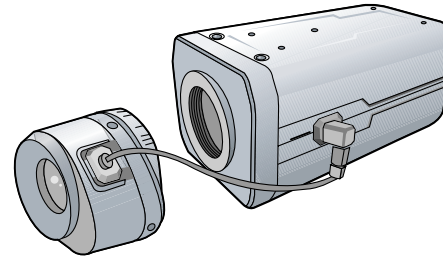

4. Set the DC / VIDEO selection switch to DC or VIDEO according to the type of the lens.

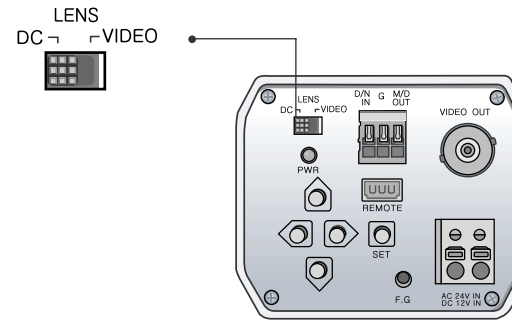



## ■ Installation Method

### ● Installing C/CS-Mount Lens

Before mounting a lens, please check whether it is a C-mount or CS-Mount lens. The back focus is set for the CS-mount lens at the factory.

### ● Mounting a CS-Mount Lens

After removing the protecting cap, attach the lens into the camera by turning clockwise.

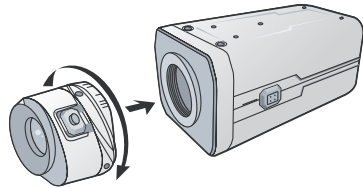

### ● Mounting a C-Mount Lens

1. Attach the C Mount lens adaptor by turning clockwise
2. Attach the lens to the camera by turning clockwise.

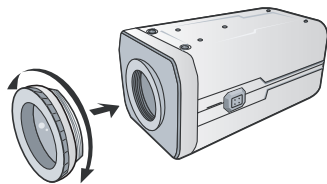

#### Notes!

- A heavy lens may disturb the balance with the camera and possibly result in damage. Don't use lens heavier than 450g.
- It is recommended to set the lens ALC mode to Av mode(Average). Pk mode can be occurred hunting.

## ■ Installation Method

### ● Connecting to Monitor

Connect the VIDEO Out jack to the monitor VIDEO in jack

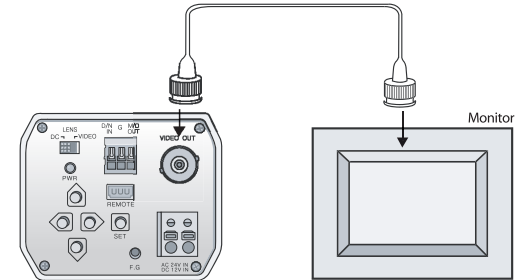

### ● Connecting to Power

Connect the power plug to a normal, grounded AC/DC outlet  
Use AC 24V/300mA or DC 12V/500mA power source.

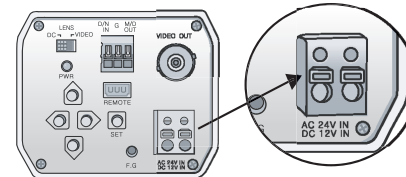

#### Notes!

- Be sure to connect power only after all the installation is complete
- Note that power adaptor is not supplied with camera
- Use the UL listed, class 2 power transformer of AC 24V adaptor
- Ground should be connected to the FGND terminal
- DC12V power is non polarity

## ■ Operating Your Camera

### ● Configuration of The Menu

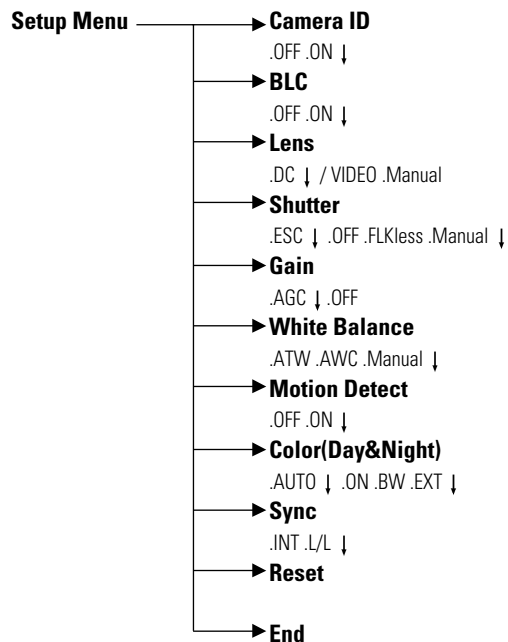

※ For the mode with ↓ you can access submenu.

## ■ Operating Your Camera

### ● Setting Up The Menu

Use the five Setup Menu buttons on rear of the camera.

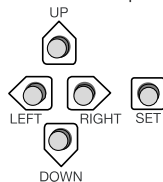

1. Press the SET button to access the Setup mode over 1sec.  
-Setup menu is displayed on the monitor screen.

Setup	
Camera ID	OFF
BLC	OFF
Lens	DC ↓
Shutter	Manual ↓
Gain	AGC ↓
White Balance	ATW
Motion Detect	OFF
Color	AUTO ↓
Sync.	INT
Reset	
End	

Select the function with the UP or DOWN button

Select the condition with the LEFT or RIGHT button

2. Select the desired feature using the UP or DOWN button.  
-Each time you press the UP or DOWN button, the arrow indicator moves up or down  
-Move the arrow indicator to the desired feature item.
3. Change the status of the selected feature using the LEFT or RIGHT button.
4. When completed, move the arrow indicator to 'End' and press the SET button.

## ■ Operating Your Camera

### □ Camera ID

If you enter a camera ID, the name will be displayed in the screen monitor.

1. Press the SET button to display the setup menu and move the arrow indicator to 'Camera ID' using the UP or DOWN button.

Setup	
Camera ID	ON ↓
BLC	OFF
Lens	DC ↓
Shutter	Manual ↓
Gain	AGC ↓
White Balance	ATW
Motion Detect	OFF
Color	AUTO ↓
Sync.	INT
Reset	
End	

Select the status "ON" or "OFF" using the LEFT or RIGHT button (If the camera ID feature is set to OFF, the name will not be displayed in the monitor.)

↓ Press SET button

ID Character	
A B C D E F G H I J K L M	
N O P Q R S T U V W X Y Z	
a b c d e f g h i j k l m	
n o p q r s t u v w x y z	
- . 0 1 2 3 4 5 6 7 8 9	
← → Clr Pos	
End	

## ■ Operating Your Camera

2. You can enter up to 15 characters.
  - 1) Move the cursor to character-enter location by 4-directional buttons.
  - 2) Selected character blinks.

ID Character	
A B C D E F G H I J K L M	
N O P Q R S T U V W X Y Z	
a b c d e f g h i j k l m	
n o p q r s t u v w x y z	
- . 0 1 2 3 4 5 6 7 8 9	
← → Clr Pos	
End	

- 3) Press the SET button to confirm the blinking character. The first character is saved and the cursor in the bottom of the screen moves to the next position.
- 4) Repeat steps 1), 2) and 3) until you create the full name you want.
3. If you make a mistake while entering name  
Move the cursor to 'Clr', press 'SET' button. After erasing the character, correct the character again.
4. To edit existing Camera ID, move the cursor to ← or → in the ID generation screen, and press SET button, After you choose ← or →, each time you press the SET button, the cursor moves to the left or right in the string of characters. When the cursor moves to the wrong character, correct the character by using the 4-directional buttons.
5. Select the position at which the camera ID will be located on the screen.
  - 1) Move the cursor to 'Pos' and press SET button.
  - 2) The camera ID is displayed on the top-left of the monitor screen (Default position)
  - 3) Select the position by using the 4-directional buttons, then press the SET button to confirm the position.
6. When completed, move the cursor to 'End' and press SET button.

## ■ Operating Your Camera

### □ Back Light Compensation (BLC)

When the image is in front of strong background lighting, that will be presented dark on the monitor. If you select this function, you can get the clear image.

1. Press the SET button to display the setup menu and move the arrow indicator to 'BLC' using the UP or DOWN button

Setup	
Camera ID	OFF
BLC	ON ↓
Lens	DC ↓
Shutter	OFF
Gain	AGC ↓
White Balance	ATW
Motion Detect	OFF
Color	AUTO ↓
Sync.	INT
Reset	
End	

Select "ON" using the LEFT or RIGHT button

2. When BLC selected to 'ON', press the SET button. You can control the level of weight.

Setup	
Weight	2
Press SET to Return	

Select the weight number (0~4) using the LEFT or RIGHT button

※ As the weight level is high, the BLC area is limited to the middle of the screen, and the sensitivity gets rate.

## ■ Operating Your Camera

### □ Lens Selection

You can set the type of the lens, and control the brightness of the screen.

1. Press the SET button to display the setup menu and move the arrow indicator to 'Lens' using the UP or DOWN button

Setup	
Camera ID	OFF
BLC	OFF
Lens	DC ↓
Shutter	OFF
Gain	AGC ↓
White Balance	ATW
Motion Detect	OFF
Color	AUTO ↓
Sync.	INT
Reset	
End	

Select the DC/Video or Manual using the LEFT or RIGHT button

2. When the auto iris lens is mounted, you have to set the DC/Video selection switch on the back side of the camera. The setup window displays DC or Video according to status of this selection switch.



3. If you select 'DC' mode, you can adjust the desired brightness. For a stable performance, the level '10' is recommended.

Setup	
Iris Level	10
Press SET to Return	

Select the level using the LEFT or RIGHT button (0~30)

## ■ Operating Your Camera

### □ Shutter Speed Control

You can control brightness of the screen by the shutter speed. You can select the automatic control and 'OFF' (1/60 or 1/50sec. fixed) mode, Flickerless and manual control of the shutter.

1. Press the SET button to display the setup menu and move the arrow indicator to 'Shutter' using the UP or DOWN button

Setup	
Camera ID	OFF
BLC	OFF
Lens	DC ↓
Shutter	OFF
Gain	AGC ↓
White Balance	ATW
Motion Detect	OFF
Color	AUTO ↓
Sync.	INT
Reset	
End	

Select "Shutter" to the desired mode like ESC, OFF, FLKless or Manual using the LEFT or RIGHT button

#### 2. ESC selected

- The electronic shutter can be automatically controlled from 1/60(1/50) to 1/10,000sec.
- The brightness can be controlled.
- If Auto Iris Lens is mounted and adjusted, ESC mode cannot be selected.

#### 3. OFF selected

- The shutter speed is fixed at 1/60(1/50)sec.

#### 4. FLKless selected

- The speed is fixed at 1/100sec. in NTSC mode and at 1/120sec. in PAL mode.
- This should be selected when flickering is caused by discord of environmental lighting and frequency

## ■ Operating Your Camera

### 5. Manual

- You can select speed from 1/60 to 1/10,000sec. (NTSC mode), 1/50 to 1/10,000sec. (PAL mode)

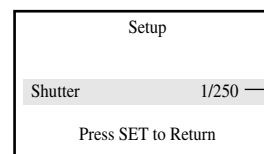

Change the range using the LEFT or RIGHT button. (1/60, 1/50~1/10,000)

- When the shutter speed is increased or decreased using the LEFT or RIGHT button, you can find the difference by monitoring the brightness of the screen.

## ■ Operating Your Camera

### □ Gain Control

You can see a brighter picture at low light level. Increasing the gain level, you will see the noise increased although the picture gets brighter.

1. Press the SET button to display the setup menu and move the arrow indicator to 'Gain' using the UP or DOWN button

Setup	
Camera ID	OFF
BLC	OFF
Lens	DC ↓
Shutter	OFF
Gain	AGC ↓
White Balance	ATW
Motion Detect	OFF
Color	AUTO ↓
Sync.	INT
Reset	
End	

Select AGC or OFF using the LEFT or RIGHT button

2. You can control the Gain level at AGC selected.

Gain Limit	Middle
Press SET to Return	

Low/Middle/High

※ **Caution.**

When Gain Limit is set to Low, screen noise will decrease but resolution decrease.

When Gain Limit is set to High, resolution will increase but screen noise will increase.

## ■ Operating Your Camera

### □ White Balance Control

You can use this when the screen color needs to be controlled.

1. Press the SET button to display Setup menu and move the arrow indicator to 'White Balance' using the UP or DOWN button

Setup	
Camera ID	OFF
BLC	OFF
Lens	DC ↓
Shutter	OFF
Gain	AGC ↓
White Balance	ATW
Motion Detect	OFF
Color	AUTO ↓
Sync.	INT
Reset	
End	

Select ATW, AWC or Manual using the LEFT or RIGHT button

2. The three white balance control modes are as follows :

- **ATW** (Auto Trace White Balance )

The camera automatically controls the white balance in any environment

- **AWC** ( Auto White Balance Control )

The white balance is automatically adjusted in a specific environment.

In order to obtain the best result, press the SET button while the camera focused on white paper.

If the environment including the light source is changed, you have to adjust the white balance again.

## ■ Operating Your Camera

### • Manual

To fine adjust, select the Manual mode. You can increase or decrease the red or blue factor while monitoring the difference on the screen. Set to 'Manual' mode and press the 'SET' button.

Increase or decrease the value for red(R-Gain) and blue(B-Gain), watching the color of the picture, and press the SET button when you obtain the best color.

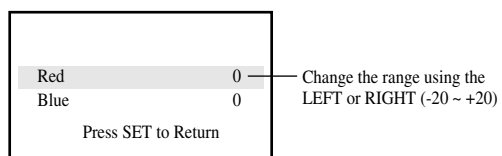

## ■ Operating Your Camera

### □ Motion Detection

Your camera transmits an alert signal when it detects motion of an object on the screen. If you connect the camera to an external alarm, you can pay attention to the screen when the alarm sounds. This feature is useful when you have to monitor several screens simultaneously.

1. Press the SET button to display the setup menu and move the arrow indicator to 'Motion Detect' using the UP or DOWN button.

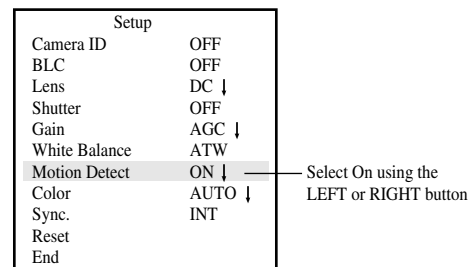

↓ SET button pushed

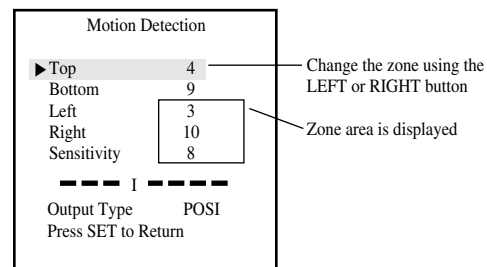

## ■ Operating Your Camera

### 2. Specify the zone area.

- You can specify the zone area by setting a proper value from 0 to 15 with an increment of 1. Move the arrow indicator to 'Top' using the UP or DOWN button and increase or decrease the value using the LEFT or RIGHT button. Repeat the procedure for bottom, left, and right.

### 3. Adjust Sensitivity

- Move the arrow indicator to 'Sensitivity' using the UP or DOWN button, then press the LEFT or RIGHT button to decrease or increase the value.
- If you decrease the sensitivity, the camera will detect only motion that is clearly noticeable. If you want to set the camera to detect minor motion, increase the sensitivity.
- You can select the sensitivity from 0 to 15. Higher sensitivity detects smaller motions at the risk of false detection. Therefore zone adjustment is recommended rather than sensitivity adjustment.

### 4. Adjust the output signal.

- POSI(Positive) : When a motion is sensed, +5V of Pulse will be output
- NEGA(Negative) : When a motion is sensed, 0V of Pulse will be output
- ALARM : You can connect external equipment like buzzer or lamp. The output of alarm is an open collector under DC16V & 100mA capacity.

#### ※ Tips on using Motion Detection

- After selecting zone and sensitivity, perform a test operation to make sure it works properly.
- If the lighting flickers, the motion detection feature might not work properly.
- This system does not guarantee prevention of fires or thefts. The manufacturer is not responsible for any accident or damage.

## ■ Operating Your Camera

### □ Color (Day & Night)

Your camera provides automatic mode changeover by sensing day or night conditions. It changes to Color mode in day conditions for optimal color and to B/W mode in night conditions for clear identification.

- Press the SET button to display the setup menu and move the arrow indicator to 'Color' using the UP or DOWN button.

Setup	
Camera ID	OFF
BLC	OFF
Lens	DC ↓
Shutter	OFF
Gain	AGC ↓
White Balance	ATW
Motion Detect	ON ↓
Color	AUTO ↓
Sync.	INT
Reset	
End	

Select the AUTO, ON, BW, EXT. using the LEFT or RIGHT button

- Select a mode using the LEFT or RIGHT button.

- ON** : Color mode is kept up.
- B/W** : Black and white mode is kept up.
- AUTO** : The mode is changed between Color and B/W automatically depending on the brightness. Pushing the SET button at Auto mode, you can control the mode changing point and time and burst existence during the mode change to B/W mode.



## ■ Operating Your Camera

Color ↔ B/W Change	
▶ Color → B/W Point	3
Color → B/W Time	5
----- 1	
B/W → Color Time	10
----- 1 -----	
BURST	OFF
Press SET to Return	

Change the value using the LEFT or RIGHT button(1~5)

Change the value using the LEFT or RIGHT button(1~10)

Change the value using the LEFT or RIGHT button(2~20)

- Color → B/W Point : 1-5  
1 : around 1 LUX  
3 : around 3-4 LUX  
5 : around 7-8 LUX

※ **The color changing point above is based on the AGC level to the middle. You should select the proper value depending on the condition like lens.**

- Color → B/W Time : 1sec.~10sec.(1sec. term)
- B/W → Color Time : 2sec.~20sec.(1sec. term)
- BURST : OFF/ON
- **EXT** : The Color/ BW mode change can be controlled by an external Sensor or other equipment connected on the DN terminal (D/N IN) on the back side of camera.  
Pressing the SET button at EXT mode, you can control the burst existence during the mode changing to B/W mode.  
BURST : OFF/ON  
DN input terminal is pull-up of DC 5V and over 0.2mA.  
Open contact : Color mode  
Closed contact : B/W mode

### Notes!

- 1.Under Gain OFF Color/BW does not change over automatically, ON/OFF is only available.
- 2.If you change 'Gain' menu OFF to AGC, 'Color' mode change to AUTO automatically.
- 3.Adjust the focus if the camera is out of focus for changing modes.

## ■ Operating Your Camera

### □ Synchronization Mode

Two synchronization modes are available internal and External linelock. In linelock mode, it synchronizes the video signal between cameras without a synchronous generator. The linelock synchronization is only used in the areas of 60Hz(NTSC models)/50Hz(PAL models)

1. Press the SET button to display the setup menu and move the arrow indicator to 'Sync.' Using the UP or DOWN button.

Setup	
Camera ID	OFF
BLC	OFF
Lens	DC ↓
Shutter	OFF
Gain	AGC ↓
White Balance	ATW
Motion Detect	OFF
Color	AUTO ↓
▶ Sync.	L/L ↓
Reset	
End	

Select 'L/L' or 'INT' using the LEFT or RIGHT button.

↓ Press SET button

▶ Phase	45
----- 1 -----	
Press SET to Return	

Adjust the Phase level using the LEFT or RIGHT button(from 0 to 270°)

### Notes!

- When the power frequency is 60Hz, you can use linelock mode(NTSC models).  
When the power frequency is 50Hz, you can use linelock mode(PAL models).

## ■ Operating Your Camera

### □ Reset

This function resets the camera to the default setting preset at the factory.

1. Press the SET button to display the Setup menu and move the arrow indicator to 'Reset' using the UP or DOWN button.

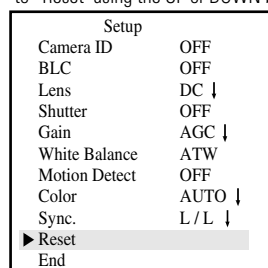

↓ Press SET button

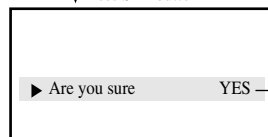

Select YES or NO using the LEFT or RIGHT button

2. In the confirmation mode, select 'YES' or 'NO' If 'YES' selected, all modes are initialized and return to the default status.

### □ End

Press the SET button to display the setup menu and move the arrow indicator to 'END' using the UP or DOWN button. Then you are finished on Setup.

### Notes!

If there's no button control at Menu over 30 sec., the setup is automatically finished with automatic update of the controlled menu by that time. However there is no time limit at Subsidiary Menu.

## ■ Using Remote Jack

### Remote Control on Setup

If you connect a remote plug to the REMOTE jack on the rear on the camera as shown below, you can access the menu setup mode from a remote place with an equipment like computer

#### 1. RS-232C Communication Setting

Mode : Serial    Data bit : 8  
Bit/sec.: 9600bps    Stop bit : 1  
Parity : None

#### 2. Wiring

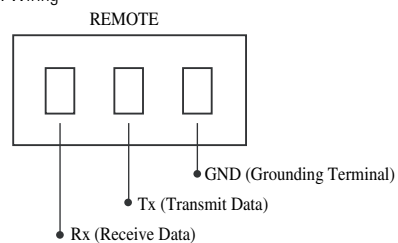

#### 3. Setup menu Command

Setup menu	Command	Byte
SET	0A, 02, 01, 00, 00, AF	6
UP	0A, 02, 02, 00, 00, AF	6
DOWN	0A, 02, 03, 00, 00, AF	6
LEFT	0A, 02, 04, 00, 00, AF	6
RIGHT	0A, 02, 05, 00, 00, AF	6

## External Connecting Terminal

### Day/Night External Signal Input/Motion Detect Output

The Color/BW mode change can be controlled by an external sensor or other equipment connected on the DN terminal(Day&Night)on the back side of camera.(Optional Function)

When you use Motion Detection mode, the appointed signal is output in every time motion detected.

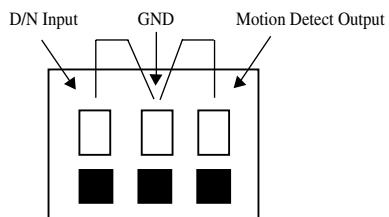

1. DN Input Terminal(over Pull-up input of DC 5V,0.2mA)

Open contact: Color mode  
Closed contact: B/W mode

2. Motion Detect Output Signal Level

• At POSI(Positive)mode

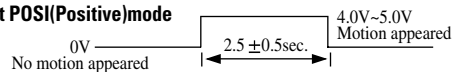

• At NEGA(Negative)mode

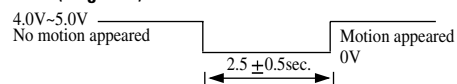

• At ALARM :You can connect an extra an equipment like lamp or buzzer on the external of camera. The output is an open collector under DC 16V/100mA.  
OFF : Open      ON : under 100mA

## Specification

ITEM	NTSC	PAL
<b>Image Sensor</b>	1/3" SONY SUPER HAD IT CCD	
<b>Picture Elements</b>	811(H) × 508( V)	795(H) × 596( V)
<b>Effective Pixels</b>	768(H) × 494( V)	752(H) × 582( V)
<b>Scanning System</b>	2:1 Interlace(NTSC Standard) 525 Line/60Fields/30Frames	2:1 Interlace(PAL Standard) 625 Line/50Fields/25Frames
<b>Resolution</b>	480(Color)/520(BW)TV Lines Horizontally	
<b>Shutter Speed</b>	1/60-1/10,000sec	1/50-1/10,000sec
<b>S/N Ratio</b>	More than 48dB(AGC OFF)	
<b>Video Output</b>	1.0 Vp-p NTSC composite	1.0 Vp-p PAL composite
<b>Min. Illumination</b>	0.5Lux at F1.2(Color) 0.03Lux at F1.2(B/W)	
<b>Sync. System</b>	Internal/Line Lock selectable	
<b>Back Light</b>	ON/OFF selectable	
<b>Iris Mode</b>	DC Iris/Video Iris/ESC selectable	
<b>White Balance</b>	ATW/AWC/MANUAL selectable	
<b>Lens Mount</b>	CS-mount(or C-mount with the supplied adaptor)	
<b>Color</b>	AUTO/ON/BW/EXT.selectable	
<b>O.S.D</b>	Built-in	
<b>RS-232C comm.</b>	Available	
<b>Power Supply</b>	AC 24V,60Hz/DC 12V(Non polarity)	AC 24V,50Hz/DC 12V(Non polarity)
<b>Power Consumption</b>	MAX. 3.0watt.	
<b>Operating Temperature</b>	-10℃ ~ +50℃...	
<b>Operating Humidity</b>	90% RH Max.	
<b>Dimension</b>	62(W) × 52(H) × 133(L)mm (Without Lens)	

## ■ Troubleshooting

If you have trouble operating your camera, refer to the following table.  
If the guidelines do not enable you to solve the problem, contact an authorized technician.

Problem	Solution
<b>The camera is not working properly</b>	▶ Check that you have properly connected the camera to an appropriate power source.
<b>Nothing appears on the screen</b>	▶ Check that the power cord and line connection between the camera and monitor are fixed properly. ▶ Check that the DC/VIDEO selection switch on the rear of the camera is set to a proper position according to the type of your auto iris lens.
<b>The image on the screen is dark</b>	▶ Check that you have set to proper iris level in the setup menu when you use the DC auto iris lens. ▶ Check that you have set to proper brightness level in the 'ESC' mode when you use the Manual iris lens.
<b>The image on the screen is dim</b>	▶ Check if the lens is stained. If dirty, clean the lens with soft, clean cloth.
<b>In the setup menu, 'AUTO' mode does not activate.</b>	▶ Check that you have properly set the 'Gain' feature under the setup menu. Set the feature to 'AGC'.
<b>The color of the picture is not matched.</b>	▶ Check that you have properly set the 'White Balance' feature under the setup menu.
<b>The contrast on the screen is too weak.</b>	▶ Adjust the contrast feature of the monitor. ▶ If the camera is exposed to too strong light, change the camera position.
<b>The image on the screen flickers</b>	▶ Is the camera facing to direct sunlight or fluorescent lighting? Change the camera position. ▶ Check that the DC/VIDEO selection switch on the rear of the camera is set to a proper position according to the type of your auto iris lens.
<b>The image on the screen is distorted</b>	▶ Check that the power frequency is proper in 'Sync'. If the power frequency is not proper, the line-lock synchronization mode cannot be used. Set the 'Sync' mode to 'INT' mode. → NTSC Model's power frequency in LL mode:60Hz → PAL Model's power frequency in LL mode:50Hz

## ■ Warranty

### MACE Security Product Warranty

Mace will repair or replace, without charge, any merchandise proved defective in material or workmanship for a period of one year after the date of shipment.

Exceptions to this warranty are as noted below:

Mace will warrant all replacement parts and repairs for 90 days from the date of Mace shipment. All goods requiring warranty repair shall be sent freight prepaid to Mace, Fort Lauderdale. Repairs made necessary by reason of misuse, alteration, normal wear, or accident are not covered under this warranty.

Mace assumes no risk and shall be subject to no liability for damages or loss resulting from the specific use or application made of the Products. Mace's liability for any claim, whether based on breach of contract, negligence, infringement of any rights of any party or product liability, relating to the Products shall not exceed the price paid by the Dealer to Mace for such Products. In no event will Mace be liable for any special, incidental or consequential damages (including loss of use, loss of profit and claims of third parties) however caused, whether by the negligence of Mace or otherwise.

If a warranty repair is required, the Dealer must contact Mace at (877) 585-6223 or (954) 585-6223 to obtain a Repair Authorization (RA) number, and provide the following information:

1. Model and serial number
2. Date of shipment, P.O. number, Sales Order number, or Mace invoice number
3. Details of the defect or problem

## Free Manuals Download Website

<http://myh66.com>

<http://usermanuals.us>

<http://www.somanuals.com>

<http://www.4manuals.cc>

<http://www.manual-lib.com>

<http://www.404manual.com>

<http://www.luxmanual.com>

<http://aubethermostatmanual.com>

Golf course search by state

<http://golfingnear.com>

Email search by domain

<http://emailbydomain.com>

Auto manuals search

<http://auto.somanuals.com>

TV manuals search

<http://tv.somanuals.com>