

SRM350v3 and SRM450v3

Powered Loudspeakers

OWNER'S MANUAL



Important Safety Instructions

1. Read these instructions.
2. Keep these instructions.
3. Heed all warnings.
4. Follow all instructions.
5. Do not use this apparatus near water.
6. Clean only with a dry cloth.
7. Do not block any ventilation openings. Install in accordance with the manufacturer's instructions.
8. Do not install near any heat sources such as radiators, heat registers, stoves, or other apparatus (including amplifiers) that produce heat.
9. Do not defeat the safety purpose of the polarized or grounding-type plug. A polarized plug has two blades with one wider than the other. A grounding-type plug has two blades and a third grounding prong. The wide blade or the third prong are provided for your safety. If the provided plug does not fit into your outlet, consult an electrician for replacement of the obsolete outlet.
10. Protect the power cord from being walked on or pinched particularly at plugs, convenience receptacles, and the point where they exit from the apparatus.
11. Only use attachments/accessories specified by the manufacturer.
12. Use only with a cart, stand, tripod, bracket, or table specified by the manufacturer, or sold with the apparatus. When a cart is used, use caution when moving the cart/apparatus combination to avoid injury from tip-over.
13. Unplug this apparatus during lightning storms or when unused for long periods of time.
14. Refer all servicing to qualified service personnel. Servicing is required when the apparatus has been damaged in any way, such as power-supply cord or plug is damaged, liquid has been spilled or objects have fallen into the apparatus, the apparatus has been exposed to rain or moisture, does not operate normally, or has been dropped.
15. This apparatus shall not be exposed to dripping or splashing, and no object filled with liquids, such as vases or beer glasses, shall be placed on the apparatus.
16. Do not overload wall outlets and extension cords as this can result in a risk of fire or electric shock.
17. This apparatus has been designed with Class-I construction and must be connected to a mains socket outlet with a protective earthing connection (the third grounding prong).
18. This apparatus has been equipped with a rocker-style AC mains power switch. This switch is located on the rear panel and should remain readily accessible to the user.
19. The MAINS plug or an appliance coupler is used as the disconnect device, so the disconnect device shall remain readily operable.

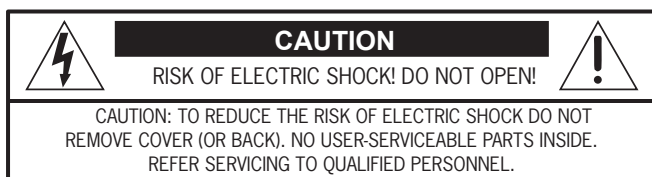

The lightning flash with arrowhead symbol within an equilateral triangle is intended to alert the user to the presence of uninsulated "dangerous voltage" within the product's enclosure, that may be of significant magnitude to constitute a risk of electric shock to persons.



The exclamation point within an equilateral triangle is intended to alert the user of the presence of important operating and maintaining (servicing) instructions in the literature accompanying the appliance.

WARNING — To reduce the risk of fire or electric shock, do not expose this apparatus to rain or moisture.

CAUTION — To prevent electric shock hazard, do not connect to mains power supply while grille is removed.



Correct disposal of this product: This symbol indicates that this product should not be disposed of with your household waste, according to the WEEE directive (2012/19/EU) and your national law. This product should be handed over to an authorized collection site for recycling waste electrical and electronic equipment (EEE). Improper handling of this type of waste could have a possible negative impact on the environment and human health due to potentially hazardous substances that are generally associated with EEE. At the same time, your cooperation in the correct disposal of this product will contribute to the effective usage of natural resources. For more information about where you can drop off your waste equipment for recycling, please contact your local city office, waste authority, or your household waste disposal service.

- 20. NOTE:** This equipment has been tested and found to comply with the limits for a Class B digital device, pursuant to part 15 of the FCC Rules. These limits are designed to provide reasonable protection against harmful interference in a residential installation. This equipment generates, uses, and can radiate radio frequency energy and, if not installed and used in accordance with the instructions, may cause harmful interference to radio communications. However, there is no guarantee that interference will not occur in a particular installation. If this equipment does cause harmful interference to radio or television reception, which can be determined by turning the equipment off and on, the user is encouraged to try to correct the interference by one or more of the following measures:

- Reorient or relocate the receiving antenna.
- Increase the separation between the equipment and the receiver.
- Connect the equipment into an outlet on a circuit different from that to which the receiver is connected.
- Consult the dealer or an experienced radio/TV technician for help.

CAUTION: Changes or modifications to this device not expressly approved by LOUD Technologies Inc. could void the user's authority to operate the equipment under FCC rules.

- 21.** This apparatus does not exceed the Class A/Class B (whichever is applicable) limits for radio noise emissions from digital apparatus as set out in the radio interference regulations of the Canadian Department of Communications.

ATTENTION — *Le présent appareil numérique n'émet pas de bruits radioélectriques dépassant les limites applicables aux appareils numériques de class A/de class B (selon le cas) prescrites dans le règlement sur le brouillage radioélectrique édicté par les ministères des communications du Canada.*

- 22.** Exposure to extremely high noise levels may cause permanent hearing loss. Individuals vary considerably in susceptibility to noise-induced hearing loss, but nearly everyone will lose some hearing if exposed to sufficiently intense noise for a period of time. The U.S. Government's Occupational Safety and Health Administration (OSHA) has specified the permissible noise level exposures shown in the following chart.

According to OSHA, any exposure in excess of these permissible limits could result in some hearing loss. To ensure against potentially dangerous exposure to high sound pressure levels, it is recommended that all persons exposed to equipment capable of producing high sound pressure levels use hearing protectors while the equipment is in operation. Ear plugs or protectors in the ear canals or over the ears must be worn when operating the equipment in order to prevent permanent hearing loss if exposure is in excess of the limits set forth here:

Duration, per day in hours	Sound Level dBA, Slow Response	Typical Example
8	90	Duo in small club
6	92	
4	95	Subway Train
3	97	
2	100	Very loud classical music
1.5	102	
1	105	Greg screaming at Troy about deadlines
0.5	110	
0.25 or less	115	Loudest parts at a rock concert

Laitte on liitettävä suojakoskettimilla varustettuun pistorasiaan.

Apparatet må tilkoples jordet stikkontakt.

Apparaten skall anslutas till jordat uttag.

Contents

- Important Safety Instructions 2
- Contents..... 3
- Features 3
- Introduction 4
- How To Use This Manual 4
- Getting Started..... 4
- Things To Remember..... 4
- Hookup Diagrams..... 5

- SRMv3 Loudspeaker: Rear Panel Features 9
 - 1. Power Connection 9
 - 2. Power Switch..... 9
 - 3. XLR and 1/4" Combo Inputs..... 9
 - 4. Gain Knobs..... 10
 - 5. RCA Inputs [Channel 2 Only] 10
 - 6. Thru Output..... 10
 - 7. Ch 1/Mix Switch [Thru Output]..... 11
 - 8. Speaker Mode 11
 - 9. Feedback desTROyEr 11
 - 10. Main LED Switch / Limit LED 11
 - 11. Breakfast Mode..... 11

- Smart Protect 12
 - Limiting..... 12
 - Overexcursion Protection 12
 - Thermal Protection..... 12

- AC Power 12
- Care and Maintenance 12

- Placement..... 13
 - Room Acoustics..... 14

- Rigging 15
 - Rigging Design Practices..... 15
 - Rigging Hardware and Accessories..... 15
 - Rigging Notes..... 15
 - SRMv3 Inserts & Fly Points..... 15

- Appendix A: Service Information 16
- Appendix B: Connections 17
- Appendix C: Technical Information 18
 - SRMv3 Loudspeaker Dimensions..... 20
 - SRMv3 Loudspeaker Frequency Responses 21
 - SRMv3 Loudspeaker Block Diagram 22

- Limited Warranty..... 23

Features

- 1000W system power paired with custom transducers deliver gig-level volumes with room to spare
 - 10" high-output LF driver [SRM350v3]
 - 12" high-output LF driver [SRM450v3]
 - 1.4" titanium dome compression driver

- High-Definition Audio Processing for professional sound with unmatched clarity
 - Patented acoustic correction developed with touring geniuses at EAW®
 - Precision 2-way crossover
 - Driver time alignment and phase correction

- Quick one-button Speaker Mode selection for application-specific voicing (PA, DJ, Monitor and Soloist)

- Effortlessly eliminate nasty feedback with one-button automatic Feedback Destroyer

- Integrated 2-channel mixer featuring dual Wide-Z™ inputs
 - Handles anything from mics to guitars to mixers with a single twist of the gain knob
 - Includes stereo RCA inputs for easy connection to music source
 - Perfect for the singer/songwriter, plug in and leave the mixer at home

- Smart Protect™ DSP kicks in to protect your investment when things get pushed a little too hard

- Monitor-specific angle and voicing mode perfect for cutting through on stage

- Flyable for permanent install

- Proven highly-durable, portable design
 - 23.0 lb / 10.4 kg [SRM350v3]
 - 37.0 lb / 16.8 kg [SRM450v3]



Like us



Follow us



Watch our dang videos

Introduction

The most widely used portable speakers ever; the all-new SRM450 and SRM350 deliver the unparalleled ease-of-use, professional sound quality and indestructible portability that made SRM a live sound legend. Now packed with 1000W of power, the widest selection of truly useful sound-enhancing DSP and setup-friendly audio tools, SRM is ready for your high-output application.

SRMs feature modern tools like application-specific speaker modes and an automatic feedback destroyer, each with a single-button interface that gets you optimized performance in just seconds. And with the integrated 2-channel mixer, you can easily mix multiple sources.

Only SRMs deliver this level of power and sound quality in such an indestructible, portable package.

How to Use This Manual:

After this introduction, a getting started guide will help you get things set up fast. The hookup diagrams show some typical setups, while the remaining sections provide details of the SRM350v3 and SRM450v3 loudspeakers.



This icon marks information that is critically important or unique to the loudspeakers. For your own good, read and remember them.

Please write your serial number here for future reference (i.e., insurance claims, tech support, return authorization, make dad proud, etc.)

Purchased at:

Date of purchase:

Getting Started

The following steps will help you set up the loudspeakers quickly.

1. Make all initial connections with the power switches OFF on all equipment. Make sure the master volume, level, or gain controls are all the way down.
2. Connect the line-level outputs from the mixing console (or other signal source) to the inputs on the rear panel of the SRM350v3 / SRM450v3 loudspeakers.
3. Make sure that the loudspeaker's gain knobs are set to (or near) "line".
4. Connect the supplied AC power cords to the IEC sockets on the rear panel of each loudspeaker. Plug the other end into an AC outlet properly configured with the correct voltage as indicated below the IEC socket.
5. Turn the mixer (or other signal source) on.
6. Turn the loudspeakers on.
7. Start the signal source and raise the mixer's main L/R fader up until audio may be heard through the loudspeakers.
8. Adjust the master volume of the mixer to a comfortably loud listening level.
9. Read the rest of this manual to learn how to set the speaker mode and feedback destroyer to really dial in a sound for the venue.

Things to Remember:

- Never listen to loud music for prolonged periods. Please see the Safety Instructions on page 2 for information on hearing protection.
- As a general guide, SRMv3 loudspeakers should be turned on last, after any mixer or other signal source. As such, they should also be turned off first. This will reduce the possibility of any turn-on or turn-off thumps and other noises generated by any upstream equipment from coming out of the speakers.
- Save the shipping boxes and packing materials! You may need them someday. Besides, the cats will love playing in them and jumping out at you unexpectedly. Remember to pretend like you are surprised!
- Save your sales receipt in a safe place.

Hookup Diagrams

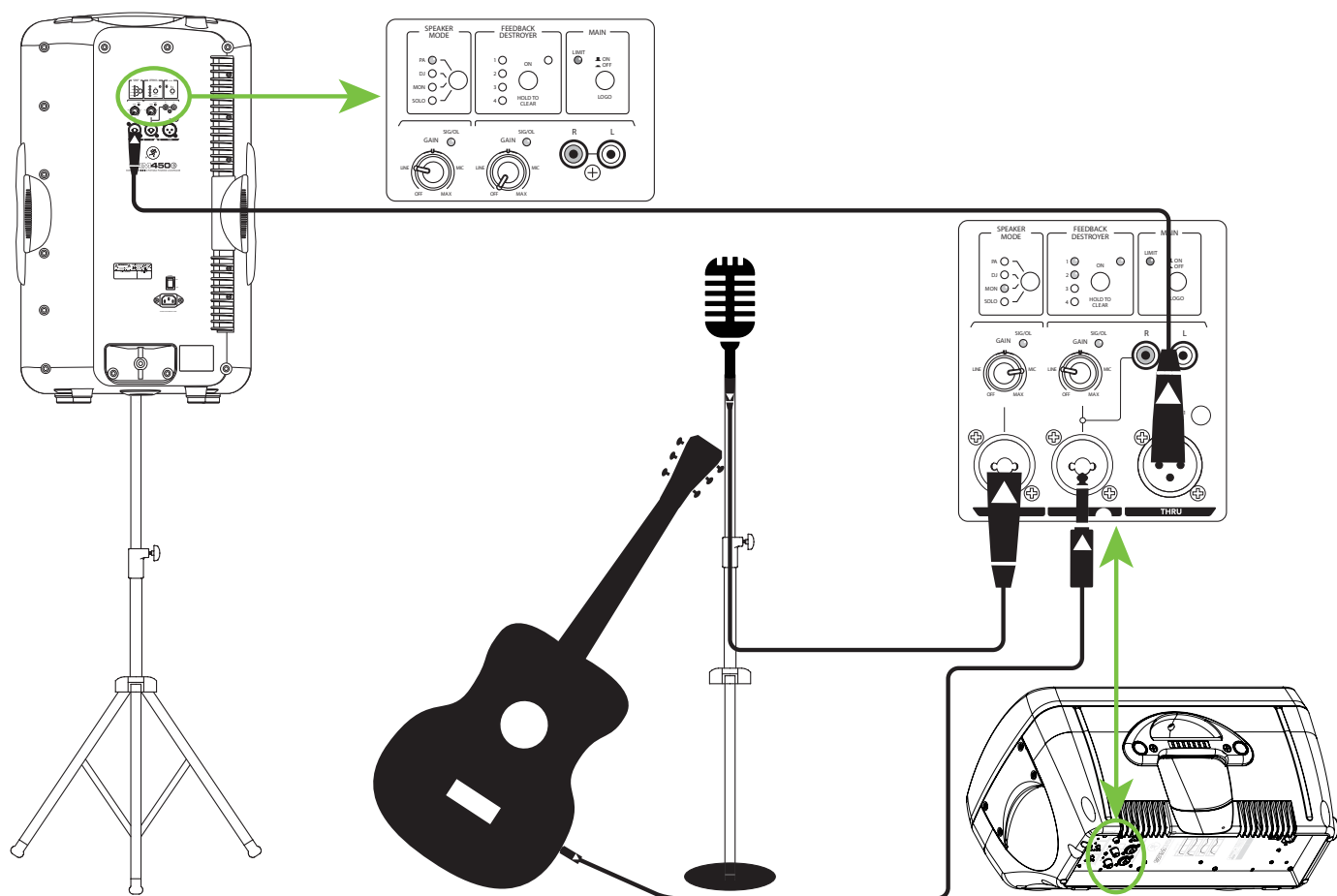

SRMv3 loudspeakers are the perfect tool for singer-songwriters touring the local coffee shops. Bring your favorite axe and mic, SRMv3 loudspeakers and cables and power cords.

In this example, a dynamic microphone is connected to the channel 1 input of an SRM350v3 loudspeaker, used for monitoring purposes. Be sure that the gain knob is set to "mic" in order to get an extra boost for the mic. If anything other than a microphone is attached to a channel input, make sure the gain knob is set to anything other than "mic" ["line" is a safe bet]. From there, adjust the gain as described on page 10.

Now grab your axe and plug it directly into the channel 2 input. Or if you use effects, connect the guitar to the effects input and another cable from the effects output to the channel 2 input. Set the channel two gain knob to "line".

An SRM450v3 loudspeaker will be used for the main PA. Simply connect a cable from the SRM350v3 loudspeaker's THRU jack to the SRM450v3 loudspeaker's channel 1 input [gain knob set to "line"]. Also, make sure the Ch 1/Mix switch is down on the main SRM350v3, as well, so a mix of the vocals and guitar is relayed to the PA.

For the output, you will want to set a speaker mode, described in detail on page 11. For this type of setup, PA works well for the main SRM450v3. However, don't count out the soloist mode! It has a nice low cut and a brilliant high end. Select the monitor mode for the SRM350v3 monitor. Lastly, you can ring out before you play, utilizing the SRMv3's feedback destroyer [page 11] or just let it kill the feedback while playing.

Small Coffee Shop

Hookup Diagrams continued...

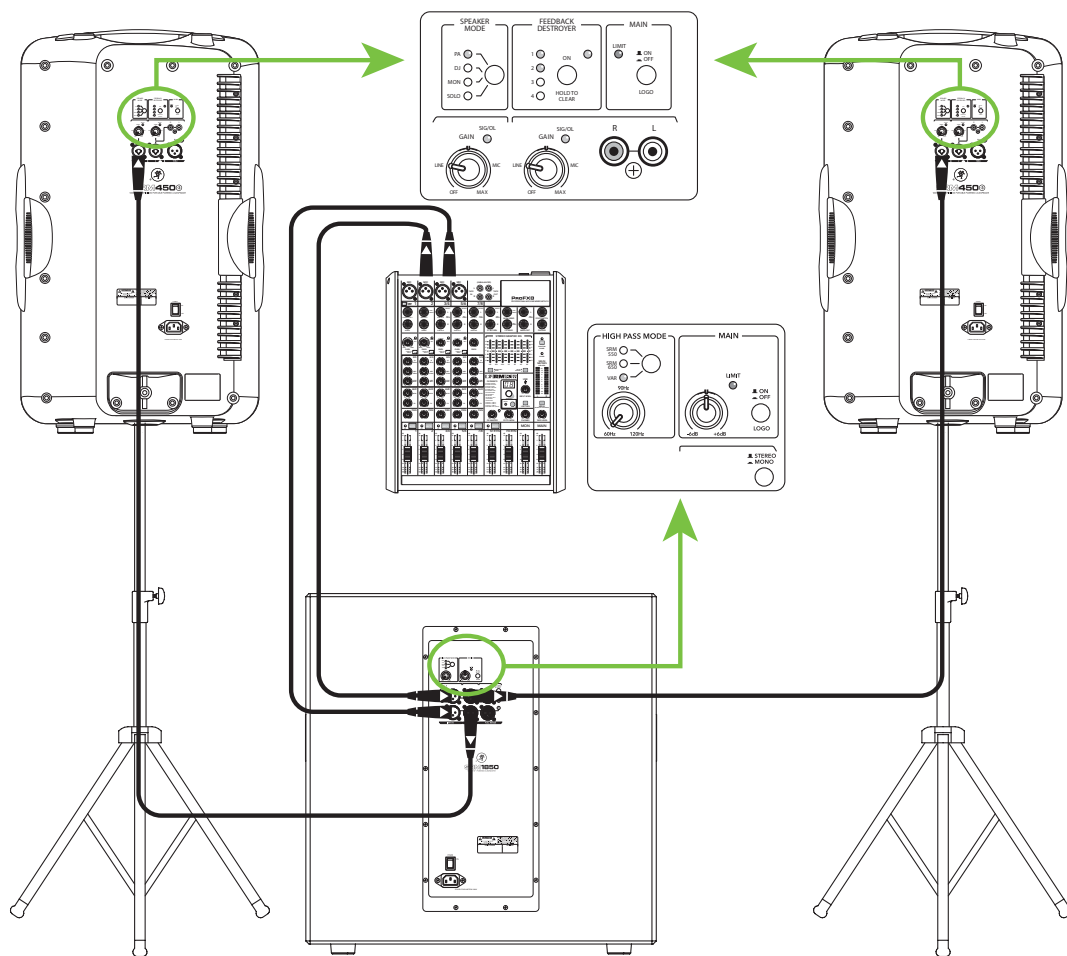

In this example, an SRM1850 subwoofer and additional SRM450v3 loudspeaker have been added to the mix, giving our sound system some extra beef. It is a perfect setup for a small club.

Here, the L/R outputs of a ProFX8 mixer are connected directly to the channel A and B inputs of a single SRM1850 subwoofer. Set the gain to "U".

The channel A and B high pass outputs of the SRM1850 subwoofer are connected directly to the channel 1 inputs of each SRM450v3 loudspeaker. Be sure that the gain knob on each is set to "line". Select the VAR high pass mode on the SRM1850 and turn the adjacent knob to 120 Hz for a matched system.

SRMv3 loudspeakers are also perfect for use as stage monitors. Simply connect a cable from each aux send to the channel 1 input of each SRMv3 loudspeaker used as a monitor. It's a good idea to use the Feedback Destroyer here.

For the output, you will want to set a speaker mode, described in detail on page 11. For this type of setup, we recommend selecting the PA speaker mode for live sound on your SRMv3 loudspeakers. If using any SRMv3 loudspeakers as monitors, select the monitor speaker mode.

Small Club System

Hookup Diagrams continued...

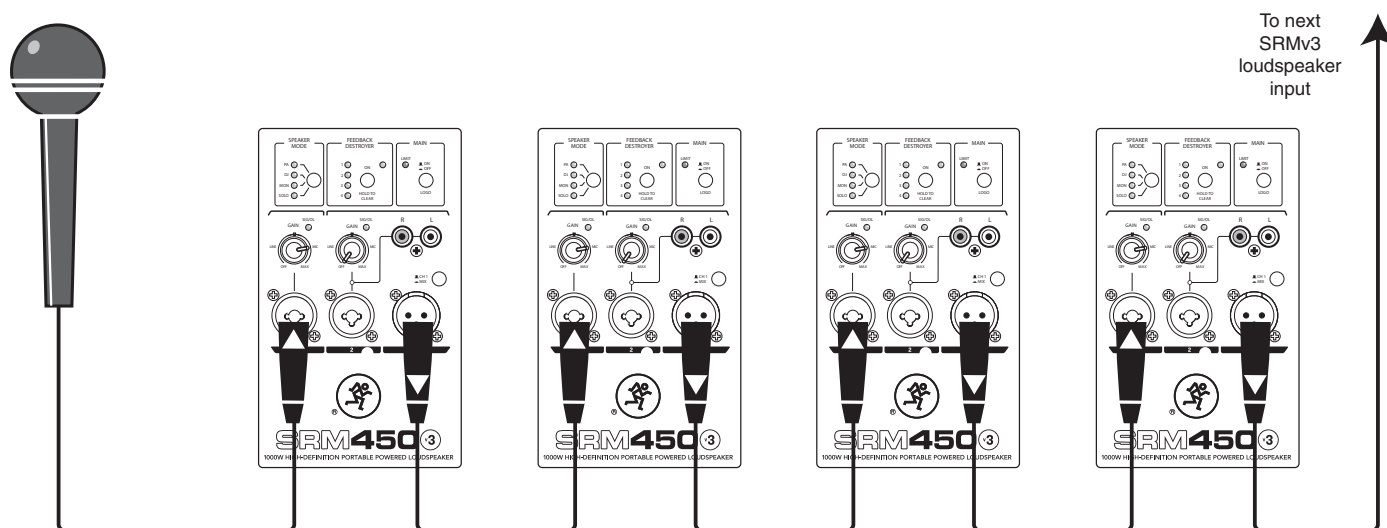
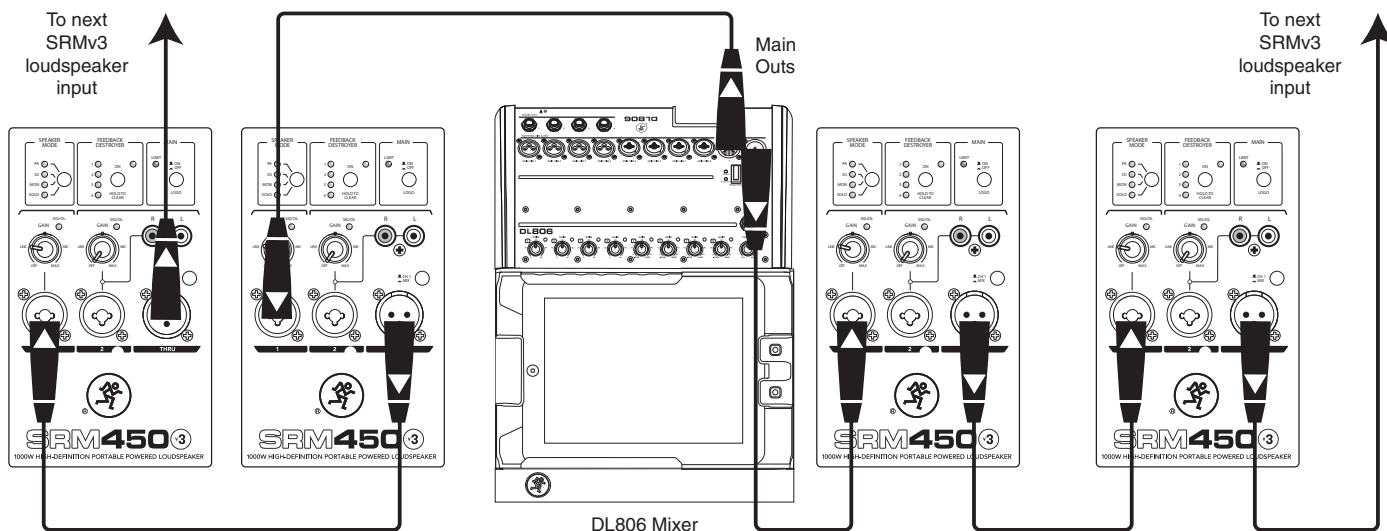

SRMv3 loudspeakers may be daisy-chained via the male XLR connector labeled "THRU". Simply plug the signal source (i.e., mixer output) into the input jack(s), and patch that loudspeaker's THRU jack to the next loudspeaker's input jack, and so on, daisy-chaining multiple SRMv3 loudspeakers. Make sure that the Ch 1 / Mix button is OUT [Ch 1]. See above for visual representations of daisy-chaining.

Daisy-Chaining Multiple SRMv3 Loudspeakers

Hookup Diagrams continued...

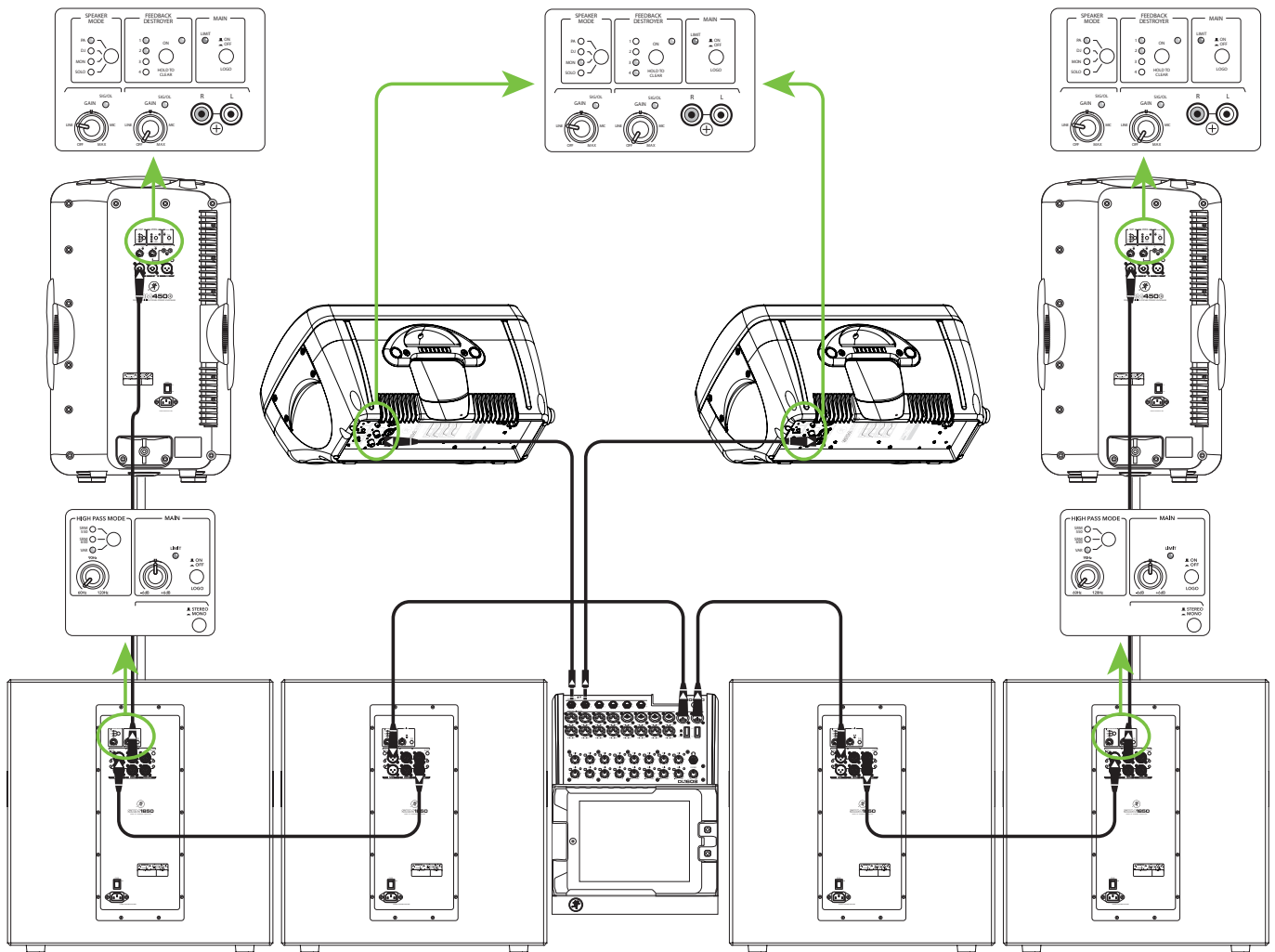

Here's how to set up a large club system. In this example, the L/R outputs of a DL1608 mixer are connected directly to the channel A inputs of two SRM1850 subwoofers. The channel A full range outputs of these two SRM1850 subwoofers are connected directly to the channel A inputs of another set of SRM1850 subwoofers. Talk about beefy low end...and we've only connected the subs!

The channel A high pass outputs of the last two SRM1850 subwoofers are connected directly to the channel 1 inputs of the main pair of SRM450v3 loudspeakers. Be sure that the gain knob on each is set to "line". Select the VAR high pass mode on the SRM1850 and turn the adjacent knob to 120 Hz for a matched system.

SRMv3 loudspeakers are also perfect for using as stage monitors. Simply connect a cable from an aux send to the channel 1 input of an SRM350v3 loudspeaker. Here you will want to set a speaker mode, described in detail on page 11. Since these are monitors, select the appropriately named monitor speaker mode.

Select PA speaker mode for the main loudspeakers. You may also turn the feedback eliminator ON on all four SRMv3 loudspeakers, if desired.

Large Club System

SRM350v3/SRM450v3 Loudspeaker: Rear Panel Features

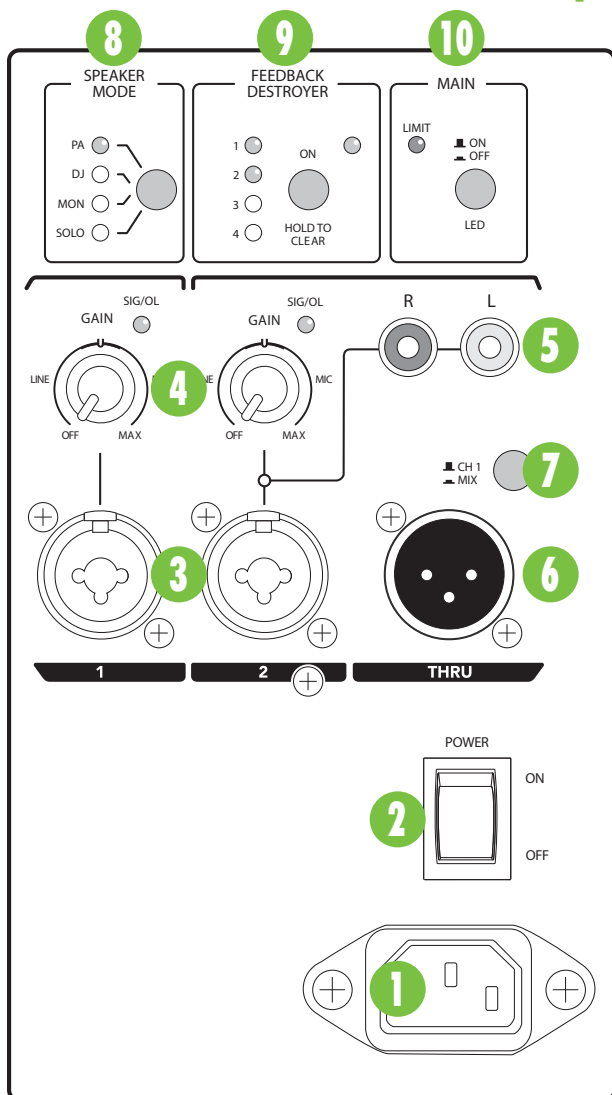

1. Power Connection

This is a standard 3-prong IEC power connector. Connect the detachable power cord (included in the packaging with the loudspeaker) to the power receptacle, and plug the other end of the power cord into an AC outlet.

VERY IMPORTANT Make sure that the AC power is matched to the AC power indicated on the rear panel (below the IEC receptacle).

VERY IMPORTANT Disconnecting the plug's ground pin is dangerous. Don't do it!

2. Power Switch

Press the top of this rocker switch inwards to turn on the loudspeaker. The front panel LED will glow with happiness...or at least it will if the loudspeaker is plugged into a suitable live AC mains supply and the main LED switch [10] is disengaged.

Press the bottom of this rocker switch inwards to turn off the loudspeaker.

VERY IMPORTANT As a general guide, SRMv3 loudspeakers should be turned on last, after any mixer or other signal source. As such, they should also be turned off first. This will reduce the possibility of any turn-on or turn-off thumps and other noises generated by any upstream equipment from coming out of the speakers.

3. XLR and 1/4" Combo Inputs

Both channels feature 1/4" Wide-Z™ inputs with combo jacks that may accept balanced/unbalanced XLR and 1/4" connections. The gain range of the Wide-Z inputs may handle anything from an instrument or mic level to a line-level signal such as from a mixer. Simply connect an XLR, TRS or TS connector into the channel and adjust the gain accordingly.

VERY IMPORTANT Please be aware of the position of the gain knob [4].

VERY IMPORTANT NEVER connect the output of an amplifier directly to the input of the loudspeaker. This could damage the input circuitry of the active loudspeaker.

XLR connectors are wired as follows, according to standards specified by the AES (Audio Engineering Society):

Balanced XLR Input Connector

- Pin 1 – Shield (ground)
- Pin 2 – Positive (+ or hot)
- Pin 3 – Negative (– or cold)

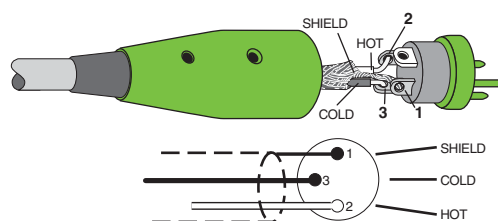

Balanced XLR Input Connector

To connect balanced lines to these inputs, use a 1/4" Tip-Ring-Sleeve (TRS) plug. "TRS" stands for Tip-Ring-Sleeve, the three connection points available on a stereo 1/4" or balanced phone jack or plug. TRS jacks and plugs are used for balanced signals and stereo headphones and are wired as follows according to standards specified by the AES (Audio Engineering Society):

SRM350v3/SRM450v3 Loudspeaker: Rear Panel Features continued...

Balanced 1/4" TRS Connector

Sleeve – Shield (ground)
Tip – Positive (+ or hot)
Ring – Negative (– or cold)

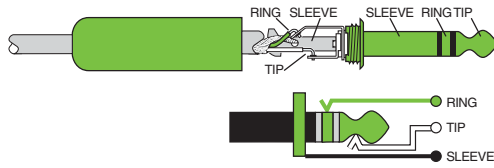
**Balanced 1/4" TRS Connector**

To connect unbalanced lines to these inputs, use a 1/4" mono (TS) phone plug, wired as follows according to standards specified by the AES (Audio Engineering Society):

Unbalanced 1/4" TS Connector

Sleeve – Shield (ground)
Tip – Positive (+ or hot)

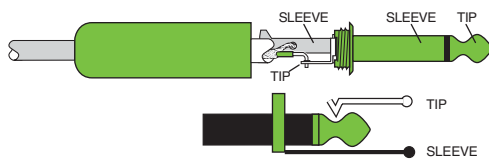
**Unbalanced 1/4" TS Connector**

For more information on these connectors, see Appendix B on page 17.

4. Gain Knobs

The gain knobs adjust the input sensitivity of the mic, line and/or RCA inputs. This allows signals from the outside world to be adjusted to run through each channel at optimal internal operating levels.

There is $-\infty$ dB of gain with the knob fully down (off), ramping up to 50 dB of gain fully up (max). The accompanying LED will illuminate green when the channel's input signal is present, indicating signal. It will remain lit so long as there is signal above -20 dBu present in that channel.

The accompanying LED will illuminate red when the amplifier in the SRMv3 loudspeaker is near the clipping point. It is okay if this LED blinks occasionally, because this means that the transient peaks are just reaching the maximum output of the amplifiers and you are getting the most out of your loudspeaker.

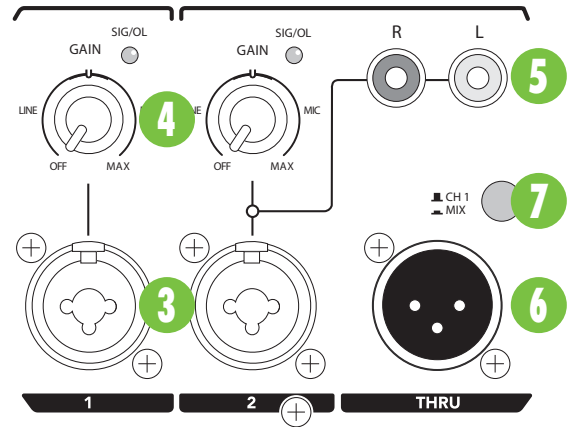

If connecting mixer outputs to loudspeaker inputs, set the gain knob to 10:00 ["Line"] for optimal sound and performance.

**5. RCA Inputs (Channel 2 Only)**

The stereo unbalanced RCA inputs allow you to play a CD player, iPod®, or other line-level source. The RCA jacks accept an unbalanced signal using standard hi-fi [RCA] hookup cables.

They are wired as follows, according to standards specified by the AES (Audio Engineering Society):

Unbalanced RCA Connector

Sleeve – Shield (ground)
Tip – Positive (+ or hot)

**Unbalanced RCA Connector**

For more information on these connectors, see Appendix B on page 17.

6. Thru Output

This is a male XLR-type connector that produces exactly the same signal that is connected to the main input jack or a mix of channels 1 and 2. Use it to daisy-chain several SRM loudspeakers together off the same signal source(s).

They are wired as follows, according to standards specified by the AES (Audio Engineering Society):

Balanced XLR Output Connector

Pin 1 – Shield (ground)
Pin 2 – Positive (+ or hot)
Pin 3 – Negative (– or cold)

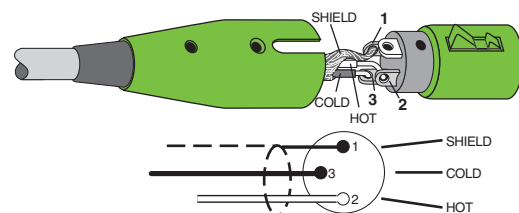
**Balanced XLR Output Connector**

See page 7 to learn more about daisy-chaining SRMv3 loudspeakers.

For more information on these connectors, see Appendix B on page 17.

7. Ch 1/Mix Switch (Thru Output)

This switch allows you to choose whether only the channel 1 signal (pre-gain) is sent out to the next loudspeaker [switch out – Ch 1] or if a mix of the channel 1 and 2 signals are sent out to the next loudspeaker [switch in – Mix] (post-gains).

8. Speaker Mode

Here you are able to change the loudspeaker's speaker mode to tailor it to best suit your particular application. There are four modes: PA, DJ, Monitor and Soloist. Press the speaker mode button repeatedly until the LED of the speaker mode you desire is illuminated. Refer to the Frequency Response graphs on page 21 for further information.

PA Speaker Mode – This mode is full range, but focuses on mid-range clarity where vocals often reside. This is the place to start for most sound reinforcement applications.

DJ Speaker Mode – This mode bumps the lows and highs with a mild tuck to the mids, perfect for music playback.

MON(itor) Speaker Mode – This mode features a low frequency roll-off and a reduction around 2 kHz to ensure maximum gain before feedback in monitor applications.

SOLO(ist) Speaker Mode – This mode features a low frequency roll-off to get rid of unwanted thumps and adds boost and sparkle to mid-range and high frequencies. This plug-and-play mode is perfect for singer-songwriters.

9. Feedback desTROYer:

The multi-band feedback destroyer hunts down offending feedback frequencies and applies up to four notch filters automatically to destroy feedback and maximize gain prior to feedback. This is a great tool for performers without a dedicated engineer.

The integrated and amazingly accurate Feedback Destroyer instantly employs up to four incredibly narrow 1/16th octave filters to locate and eradicate feedback so you know you can perform fearlessly. Plus, the entire system is protected by our Smart Protect™ DSP which kicks in to protect your investment when things get pushed a little too hard.

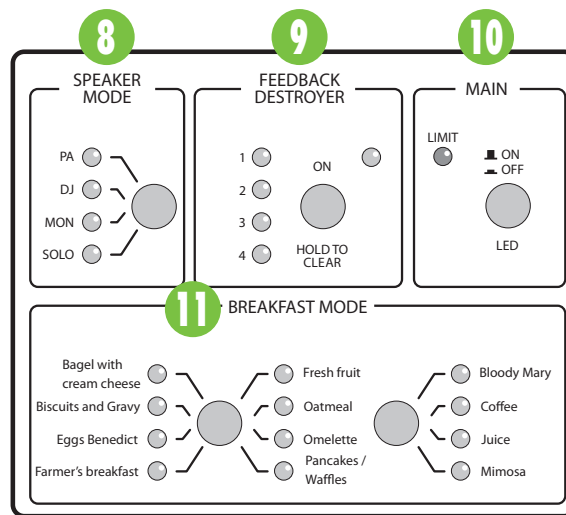

10. Main LED Switch / Limit LED

The LED on the front of the SRMv3 loudspeaker illuminates when this switch is disengaged and AC power is available at the mains input [1]. Engage the switch if you do not want the front panel LED to illuminate.

SRMv3 loudspeakers have a built-in limiter that helps to prevent the amplifier outputs from clipping or overdriving the transducers. The limit indicator illuminates yellow when the limiter is activated. It's okay for it to blink yellow occasionally, but if it blinks frequently or lights continuously, turn down the gain knob [4] until it only blinks occasionally.



Excessive limiting may lead to overheating, which in turn trips the thermal protect circuitry and interrupts the performance. See 'Thermal Protection' on page 12 for more information.

11. Breakfast Mode

Breakfast is the most important meal of the day. Here you are able to order your favorite breakfast food and drink. Press the breakfast mode buttons repeatedly until the LEDs of the food and drink you desire are illuminated. This mode is only available between 6 am and 11 am at participating SRMv3 loudspeakers.

Smart Protect

There are advanced DSP protection mechanisms designed into the SRM350v3 and SRM450v3 to safeguard the loudspeakers and amplifiers from inadvertent damage.



The protection circuits are designed to protect the loudspeakers under reasonable and sensible conditions. Should you choose to ignore the warning signs [e.g. excessive distortion], you can still damage the speaker by overdriving it past the point of amplifier clipping. Such damage is beyond the scope of the warranty.

Limiting

Each driver has its own compression circuit which helps protect it from damaging transient peaks. The compressor is designed to be transparent and is not noticeable under normal operating conditions.

Overexcursion Protection

An 18 dB/octave high-pass filter just prior to the low-frequency amplifier prevents very low frequencies from being amplified. Excessive low-frequency energy can damage the woofer by causing it to “bottom out,” also known as overexcursion, which is equivalent to a mechanical form of clipping.

Thermal Protection

All amplifiers produce heat. SRMv3 loudspeakers are designed to be efficient both electrically and thermally.

In the unlikely event of the amplifier overheating, a built-in thermal switch will activate, muting the signal.

When the amplifier has cooled down to a safe operating temperature, the thermal switch resets itself, and the SRMv3 loudspeaker resumes normal operation.

If the thermal switch activates, try turning down the level control a notch or two on the mixing console (or the back of the loudspeaker) to avoid overheating the amplifier. Be aware that direct sunlight and/or hot stage lights may be the culprit of an amplifier overheating.

AC Power

Be sure the SRMv3 loudspeaker is plugged into an outlet that is able to supply the correct voltage specified for your model. It will continue to operate at lower voltages, but will not reach full power.

Be sure the electrical service can supply enough amperage for all the components connected to it.

We recommend that a stiff (robust) supply of AC power be used because the amplifiers place high current demands on the AC line. The more power that is available on the line, the louder the speakers will play and the more peak output power will be available for a cleaner, punchier bass. A suspected problem of “poor bass performance” is often caused by a weak AC supply to the amplifiers.



Never remove the ground pin on the power cord or any other component of the SRMv3 loudspeaker. This is very dangerous.

Care and Maintenance

SRMv3 loudspeakers will provide many years of reliable service if you follow these guidelines:

- Avoid exposing the loudspeakers to moisture. If they are set up outdoors, be sure they are under cover if rain is expected.
- Avoid exposure to extreme cold (below freezing temperatures). If you must operate the loudspeakers in a cold environment, warm up the voice coils slowly by sending a low-level signal through them for about 15 minutes prior to high-power operation.
- Use a dry cloth to clean the cabinets. Only do this when the power is turned off. Avoid getting moisture into any of the openings of the cabinet, particularly where the drivers are located.

Placement



WARNING: Installation should only be done by an experienced technician. Improper installation may result in damage to the equipment, injury or death. Make sure that the loudspeaker is installed in a stable and secure way in order to avoid any conditions that may be dangerous for persons or structures.

SRMv3 loudspeakers are designed to sit on the floor or stage as the main PA or as monitors. They may also be pole-mounted via the built-in socket on the bottom of the cabinet. Be sure the pole is capable of supporting the weight of the loudspeaker. The SPM200 is a great option when using a subwoofer.

These loudspeakers may also be flown via their integrated fly points as detailed on page 15. Be sure to read the PA-A1 Eyebolt Installation Instructions, as well.

Check to make sure that the support surface (e.g. floor, etc.) has the necessary mechanical characteristics to support the weight of the loudspeaker(s).

When pole-mounting loudspeakers, be sure that they are stabilized and secured from falling over or being accidentally pushed over. Failure to follow these precautions may result in damage to the equipment, personal injury, or death.

As with any powered components, protect them from moisture. Avoid installing the loudspeaker in places exposed to harsh weather conditions. If you are setting them up outdoors, make sure they are under cover if you expect rain.

SRMv3 loudspeakers are NOT designed to array horizontally. If you feel you must put two speakers side-by-side, you should have a good understanding of the relationship between the splay angle (the angle between the facing sides of the cabinets) and frequency cancellation effects between cabinets.

When two cabinets are positioned side-by-side such that the rear-angled faces of the enclosures are parallel, the splay angle will be 90°. This matches the 90° horizontal coverage pattern of each individual loudspeaker; the interference between the two cabinets will be minimized, but the total coverage of 180° may be too wide for some applications. The mid and high frequencies may also be reduced for those in the center who are too close to the loudspeakers.

Reducing the splay angle will reduce the total horizontal coverage, but it also creates an area both speakers are covering. Instead of a nearfield hole, this will cause comb-filtering effects in the frequency response in the overlapping area. The smaller the splay angle, the more energy will be delivered on-axis, but the comb-filtering effects will get worse at the same time.

To reiterate, though, we strongly suggest NOT arraying these loudspeakers horizontally. Experimentation and experience will help you find the right balance for your application.

Room Acoustics

SRMv3 loudspeakers are designed to sound fantastic in nearly every application.

But, room acoustics play a crucial role in the overall performance of a sound system. However, the wide high-frequency dispersion of the SRMv3 loudspeakers helps to minimize the problems that typically arise.

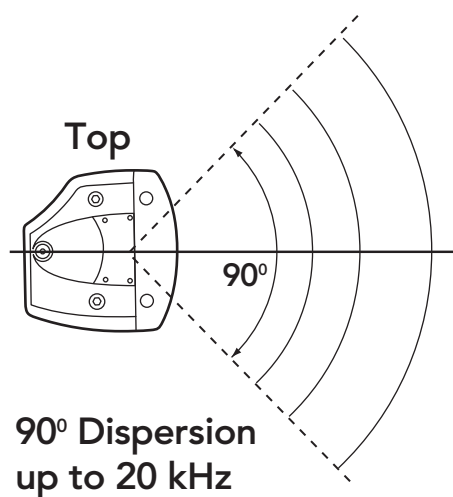

Here are some additional placement tips to help overcome some typical room problems that might arise:

- Placing loudspeakers in the corners of a room increases the low frequency output and can cause the sound to be muddy and indistinct.
- Placing loudspeakers against a wall increases the low frequency output, though not as much as corner placement. However, this is a good way to reinforce the low frequencies, if so desired.
- Avoid placing the speakers directly on a hollow stage floor. A hollow stage can resonate at certain frequencies, causing peaks and dips in the frequency response of the room. It is better to place them on a sturdy stand designed to handle the weight of the loudspeaker.

- Position the loudspeakers so the high-frequency drivers are two to four feet above ear level for the audience (making allowances for an audience that may be standing/dancing in the aisles). High frequencies are highly directional and tend to be absorbed much easier than lower frequencies. By providing direct line-of-sight from the loudspeakers to the audience, you increase the overall brightness and intelligibility of the sound system.
- Highly reverberant rooms, like many gymnasiums and auditoriums, are a nightmare for sound system intelligibility. Multiple reflections off the hard walls, ceiling, and floor play havoc with the sound. Depending on the situation, you may be able to take some steps to minimize the reflections, such as putting carpeting on the floors, closing draperies to cover large glass windows, or hanging tapestries or other materials on the walls to absorb some of the sound.

However, in most cases, these remedies are not possible or practical. So what do you do?

Making the sound system louder generally doesn't work because the reflections become louder, too. The best approach is to provide as much direct sound coverage to the audience as possible. The farther away you are from the speaker, the more prominent will be the reflected sound.

Use more speakers strategically placed so they are closer to the back of the audience. If the distance between the front and back speakers is more than about 100 feet, you should use a delay processor to time-align the sound. (Since sound travels about 1 foot per millisecond, it takes about 1/10 of a second to travel 100 feet.)

Keep in mind that the speaker mode and feedback destroyer are two great ways to compensate for some of these issues. See page 11 for more information [8, 9].

Rigging



WARNING: Installation should only be done by an experienced technician. Improper installation may result in damage to the equipment, injury or death. Make sure that the loudspeaker is installed in a stable and secure way in order to avoid any conditions that may be dangerous for persons or structures.



WARNING: The cabinet is suitable for rigging via its fly points. NEVER attempt to suspend an SRMv3 loudspeaker by its handle.

Rigging Design Practices

Rigging a loudspeaker requires determining:

1. The rigging methods and hardware that meet static, shock, dynamic, and any other load requirements for supporting the loudspeaker from structure.
2. The design factor and required WLL (Working Load Limit) for this support.

We strongly recommend the following rigging practices:

1. Documentation: Thoroughly document the design with detailed drawings and parts lists.
2. Analysis: Have a qualified professional, such as a licensed Professional Engineer, review and approve the design before its implementation.
3. Installation: Have a qualified professional rigger do the installation and inspection.
4. Safety: Use adequate safety precautions and back-up systems.

SRM350v3 Inserts

M5 inserts for mounting optional hanging bracket.

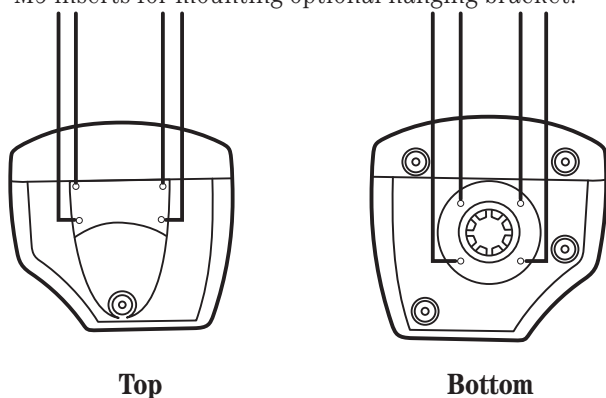

Rigging Hardware and Accessories

Rigging our loudspeakers will invariably require hardware not supplied by us. Various types of load-rated hardware are available from a variety of third-party sources. There are a number of such companies specializing in manufacturing hardware for, designing, and installing rigging systems. Each one of these tasks is a discipline in its own right. Because of the hazardous nature of rigging work and the potential liability, engage companies that specialize in these disciplines to do the work required.

We do offer certain accessory rigging items and some of them may be used with a variety of products. While these accessories are intended to facilitate installation, the wide variety of possible installation conditions and array configurations do not permit us to determine their suitability or load rating for any particular application.

We are not in the business of providing complete rigging systems, either as designers, manufacturers, or installers. It is the responsibility of the installer to provide a properly engineered, load-certified rigging system for supporting the loudspeaker from structure.



SRMv3 loudspeakers may be individually flown using a PA-A1 Eyebolt Kit, part number 0031943. SRM350v3 cabinets are fitted with four M5 insert points on the top and bottom for installing an optional hanging bracket that allows the speaker to be flown. SRM350v3 Bracket Kit: PN 0016404

Rigging Notes

The SRMv3 loudspeaker's integral mounting points are designed to support only the weight of their own loudspeaker with suitable, external hardware. This means that each SRMv3 loudspeaker must be supported independently of any other SRMv3 loudspeaker and any other loads. All rigging points must be used to hang an SRMv3 loudspeaker.

SRM450v3 Fly Points

MP = Mounting Point

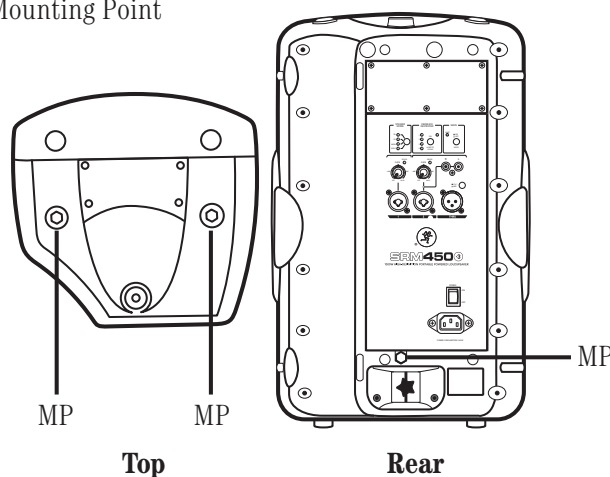

Appendix A: Service Information

If you think the SRMv3 loudspeaker has a problem, please check out the following troubleshooting tips and do your best to confirm the problem. Visit the Support section of our website (www.720trees.com) where you will find lots of useful information such as FAQs and other documentation. You may find the answer to the problem without having to part with your loudspeaker.

Troubleshooting

No power

- Our favorite question: Is it plugged in? Make sure the AC outlet is live [check with a tester or lamp].
- Our next favorite question: Is the power switch on? If not, try turning it on.
- Is the LED on the front panel illuminated? If not, make sure the AC outlet is live. If so, refer to "No sound" below.
- The internal AC line fuse may be blown. This is not a user serviceable part. If you suspect the AC line fuse is blown, please see the "Repair" section next.

No sound

- Is the input gain knob for the input source turned all the way down? Verify that all the gain knobs in the system are properly adjusted. Look at the level meter to ensure that the mixer is receiving a signal.
- Is the signal source working? Make sure the connecting cables are in good repair and securely connected at both ends. Make sure the output level control on the mixing console is turned up sufficiently to drive the inputs of the speaker.
- Make sure the mixer does not have a mute on or a processor loop engaged. If you find something like this, make sure the level is turned down before disengaging the offending switch.
- Has it shut down? Make sure there is at least six inches of free space behind each SRMv3 loudspeaker.

Poor bass performance

- Check the polarity of the connections between the mixer and the loudspeakers. You may have your positive and negative connections reversed at one end of one cable, causing one loudspeaker to be out-of-phase with the other.
- Poor bass performance may be the result of bad AC power. See the section titled 'AC Power' on page 12 for further details.

Poor sound

- Is it loud and distorted? Make sure that you're not overdriving a stage in the signal chain. Verify that all level controls are set properly.
- Is the input connector plugged completely into the jack? Be sure all connections are secure.

Noise

- What is the position of the gain knob? It should be at (or near) "mic" when a mic is connected and at (or near) "line" when a line-level signal is connected. It should be "off" for all unused inputs.
- Make sure all connections to the active loudspeakers are good and sound.
- Make sure none of the signal cables are routed near AC cables, power transformers, or other EMI-inducing devices.
- Is there a light dimmer or other SCR-based device on the same AC circuit as the SRM loudspeaker? Use an AC line filter or plug the loudspeaker into a different AC circuit.

Hum

- Try disconnecting the cable connected to the main input jack. If the noise disappears, it could be a "ground loop," rather than a problem with the SRMv3 loudspeaker. Try some of the following troubleshooting ideas:
- Use balanced connections throughout your system for the best noise rejection.
- Whenever possible, plug all the audio equipment's line cords into outlets which share a common ground. The distance between the outlets and the common ground should be as short as possible.

Repair

For warranty service, refer to the warranty information on page 23.

Non-warranty service is available at a factory-authorized service center. To locate the nearest service center, visit www.720trees.com, click "Contact Tech Support" and select "Locate a Service Center or Distributor" [3]. Service for SRMv3 loudspeakers living outside the United States can be obtained through local dealers or distributors.

If you do not have access to our website, you may call the Tech Support department at 1-800-898-3211, Monday-Friday, during normal business hours, Pacific Time, to explain the problem. Tech Support will tell you where the nearest factory-authorized service center is located in your area.

Appendix B: Connections

Balanced XLR Input Connector

Each SRM loudspeaker has two female XLR/TRS/TS combo inputs. Be sure the cables are wired per AES (Audio Engineering Society) standards:

Balanced XLR Input Connector

- Pin 1 – Shield (Ground)
- Pin 2 – Positive (+ or hot)
- Pin 3 – Negative (– or cold)

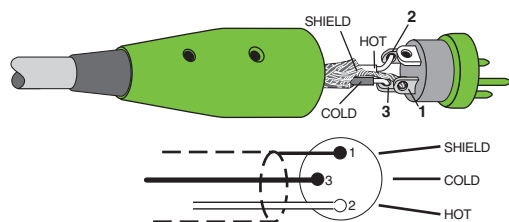

Balanced XLR Input Connector

Balanced XLR Output Connector

There is also a male XLR output on each SRM loudspeaker labeled “THRU”. Be sure the cables are wired per AES (Audio Engineering Society) standards:

Balanced XLR Output Connector

- Pin 1 – Shield (Ground)
- Pin 2 – Positive (+ or hot)
- Pin 3 – Negative (– or cold)

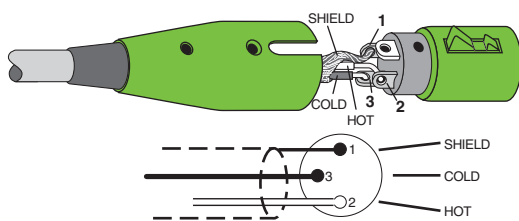

Balanced XLR Output Connector

SRM loudspeakers may be daisy-chained via the male XLR connector labeled “THRU”. Simply plug the signal source (i.e., mixer output) into the input jack(s), and patch that loudspeaker’s THRU jack to the next loudspeaker’s input jack, and so on, daisy-chaining multiple SRM loudspeakers. See page 7 for a visual representation of daisy-chaining.

Balanced 1/4" TRS Connector

TRS stands for Tip-Ring-Sleeve, the three connections available on a stereo 1/4" cable. This allows for a direct connection to the channel 1 and 2 input jacks on SRM loudspeakers. Be sure the cables are wired per AES (Audio Engineering Society) standards:

Balanced 1/4" TRS Connector

- Sleeve – Shield (Ground)
- Tip – Positive (+ or hot)
- Ring – Negative (– or cold)

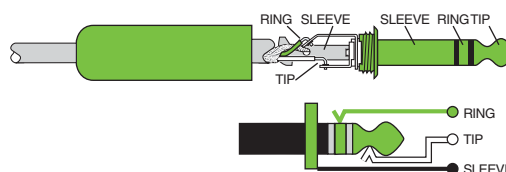

Balanced 1/4" TRS Connector

Unbalanced 1/4" TS Connector

TS stands for Tip-Sleeve, the two connections available on a mono 1/4" cable. This allows for a direct connection to the channel 1 and 2 input jacks on SRM loudspeakers. Be sure the cables are wired per AES (Audio Engineering Society) standards:

Unbalanced 1/4" TS Connector

- Sleeve – Shield (Ground)
- Tip – Positive (+ or hot)

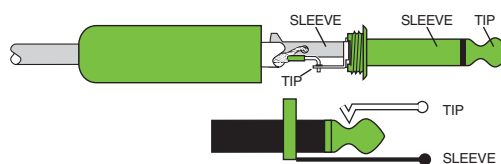

Unbalanced 1/4" TS Connector

Unbalanced RCA Connector

RCA-type plugs (also known as phono plugs) and jacks are often used in home stereo and video equipment and in many other applications. RCA plugs are unbalanced. Connect the signal to the center post and the ground (earth) or shield to the surrounding “basket.” Be sure the cables are wired per AES (Audio Engineering Society) standards:

Unbalanced RCA Connector

- Sleeve – Shield (Ground)
- Tip – Positive (+ or hot)



Unbalanced RCA Connector

Appendix C: Technical Information

SRMv3 Loudspeaker Specifications

Acoustic Performance:

Frequency Response (-3 dB)	55 Hz – 20 kHz [SRM350v3]
	47 Hz – 20 kHz [SRM450v3]
Frequency Response (-10 dB)	50 Hz – 23 kHz [SRM350v3]
	42 Hz – 23 kHz [SRM450v3]
Max peak SPL	126 dB [SRM350v3]
	128 dB [SRM450v3]
Crossover Point	3 kHz
Dispersion [H x V]	90° x 80° [SRM350v3]
	90° x 45° [SRM450v3]

High-Frequency Section

Compression Driver	1.4 in / 36 mm
Diaphragm Material	Titanium
Magnet Material	Ferrite

Low-Frequency Section

Woofer Diameter	10 in / 254 mm [SRM350v3]
	12 in / 305 mm [SRM450v3]
Cone Material	Paper
Magnet Material	Ferrite

Power Amplifiers

System Power Amplification	
Rated Power	500 watts rms 1000 watts peak
Low Frequency Power Amplifier	
Rated Power	400 watts rms 800 watts peak
Rated THD	< 1%
Cooling	Convection
Design	Class D
High Frequency Power Amplifier	
Rated Power	100 watts rms 200 watts peak
Rated THD	< 1%
Cooling	Convection
Design	Class AB

Input/Output

Channel 1		
Mic-Line		8 k Ω balanced
1/4" TRS, Wide-Z™		1 M Ω unbalanced
Channel 2		
Mic-Line		8 k Ω balanced
1/4" TRS, Wide-Z™		1 M Ω unbalanced
RCA		25 k Ω unbalanced
Thru		Male XLR balanced
	[Passive when the Ch 1 / Mix switch is in the "out" (Ch 1) position]	
	[Active when the Ch 1 / Mix switch is in the "in" (Mix) position]	

Line Input Power

US detachable line cord	100 – 120 VAC, 50 – 60 Hz, 160W
EU detachable line cord	220 – 240 VAC, 50 – 60 Hz, 160W
AC Connector	3-pin IEC 250 VAC, 10 A male
Power Supply Type	Switchmode

Safety Features

Input Protection	Peak and RMS limiting, power supply and amplifier thermal protection
Display LEDs	Defeatable front power, input signal/OL, speaker mode, feedback destroyer on/off and active filters, system limiter

Construction Features

Cabinet	Polypropylene
Finish	Black, textured finish
Grille	Perforated metal with weather-resistant coating
Monitor Angle	50° [SRM350v3]
	40° [SRM450v3]

SRMv3 Loudspeaker Specifications continued...

Physical Properties

SRM350v3:

Height	20.8 in / 527 mm
Width	13.1 in / 333 mm
Depth	12.3 in / 311 mm
Weight	23 lb / 10.4 kg

SRM450v3:

Height	26.1 in / 663 mm
Width	16.0 in / 406 mm
Depth	14.8 in / 376 mm
Weight	37 lb / 16.8 kg

Mounting Methods

SRM350v3: Floor mount, pole mount or fly via optional bracket.

SRM450v3: Floor mount, pole mount or fly via three integrated M10 mounting points (using M10 x 1.5 x 20 mm forged shoulder eyebolts).

See page 15 for more information.

Options

SRM350v3 Bag	P/N 093-024-00
SRM450v3 Bag	P/N 0002843
SPM200 Loudspeaker Pole Mount	P/N 2035170-01
SRM350v3 Bracket Kit	P/N 0016404
PA-A1 Forged Shoulder Eyebolt Kit (3 x M10 x 1.5 x 20 mm)	P/N 0031943

Disclaimer

Since we are always striving to make our products better by incorporating new and improved materials, components, and manufacturing methods, we reserve the right to change these specifications at any time without notice.

The "Running Man" figure is a registered trademark of LOUD Technologies Inc.

All other brand names mentioned are trademarks or registered trademarks of their respective holders, and are hereby acknowledged.

©2014 LOUD Technologies Inc.
All Rights Reserved.

Uncle Bill's Hot Crab Dip

Ingredients:

- 8 tablespoons cream cheese
- 1/2 cup mayonnaise (Kraft Miracle Whip is preferred)
- 7 1/2 ounces canned crab meat, drained or 7 1/2 ounces use fresh crabmeat
- 4 tablespoons minced onions
- 1 tablespoon fresh lemon juice
- 1/8 teaspoon Tabasco sauce or 1/8 teaspoon red hot sauce

Directions:

- Preheat oven to 350 F degrees.
- In a mixing bowl using an electric mixer, beat cream cheese and mayonnaise until smooth.
- Stir in crabmeat, minced onion, lemon juice and Tabasco sauce.
- Spoon mixture into a small oven-proof dish that has been sprayed with a good vegetable oil.
- Bake in preheated 350 F oven for 20 minutes or until sauce is bubbly.
- Serve with crackers of your choice, potato chips, tortilla or taco chips.
- NOTE: For those who prefer a spicier dip, add additional Tabasco sauce, also 2 teaspoons of Worcestershire sauce.
- You may consider adding about 4 Gherkin pickles chopped small.

Still reading?

Well, apparently you like to read, even if it just the fine print. That said, you might enjoy my lil e-zine: One Louder Magazine

Please visit the website at www.oneloudermagazine.com

You may also find us on all the typical social media sites. Please free to 'like' and/or 'follow' One Louder Magazine.

Should you have an idea for a good interview, don't hesitate to reach out: oneloudermagazine@gmail.com

You can't possibly still be reading this, can you?

Well stop. It's time to test drive the loudspeakers. Go give 'em a whirl! You can do this later.

Ok, fine, you're going to keep reading even though there is nothing of any significance written here.

I'll just keep making the font smaller and smaller.

And I'll keep writing gibberish until I run out of space...

...but there is nothing to see here.

In fact, here's some gibberish, otherwise known as placeholder text: Gendi del iniet, vellam eremporerum iur res.

Don't look it up. There is no meaning to it.

This text is a tip.

SRM350v3 Loudspeaker Dimensions

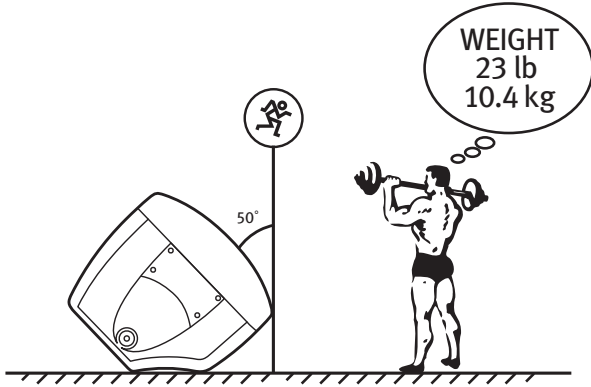
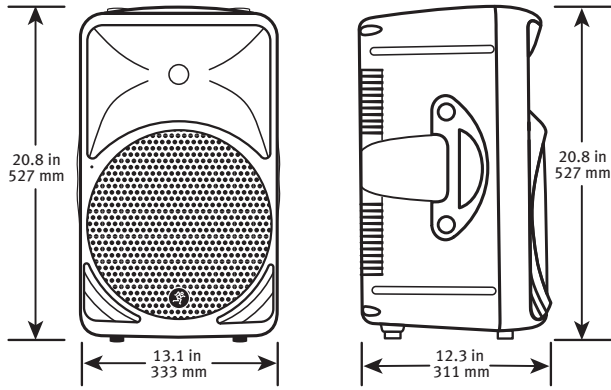

SRM450v3 Loudspeaker Dimensions

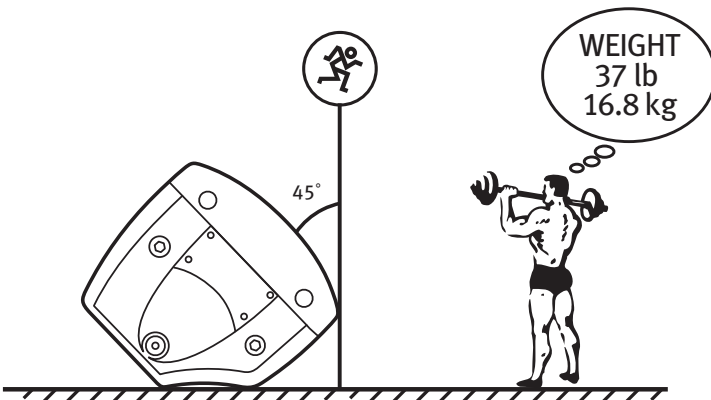
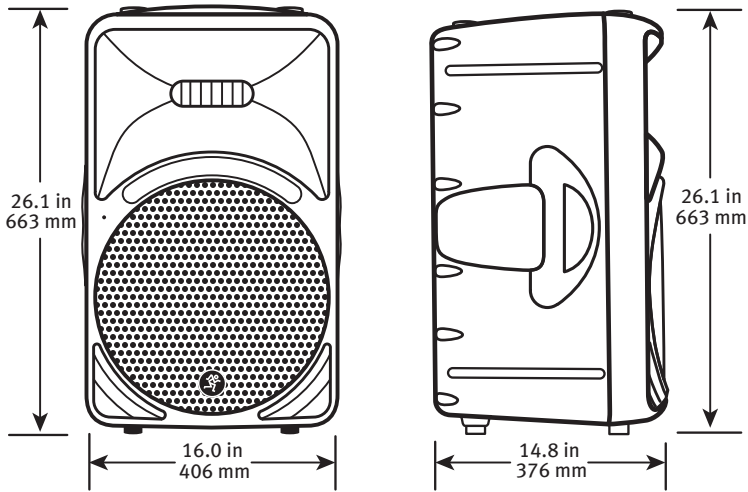

SRM350v3 and SRM450v3 Loudspeaker Frequency Response Legend

PA Speaker Mode – This mode is full range, but focuses on mid-range clarity where vocals often reside.

Soloist Speaker Mode – This mode features a low frequency roll-off to get rid of unwanted thumps and adds boost and sparkle to mid-range and high frequencies. This mode is perfect for plug-and-play singer-songwriters.

DJ Speaker Mode – This mode bumps the lows and highs with a mild tuck to the mids, perfect for music playback.

Monitor Speaker Mode – This mode features a low frequency roll-off and a reduction around 2 kHz to ensure maximum gain before feedback in monitor applications.

SRM350v3 Loudspeaker Frequency Response

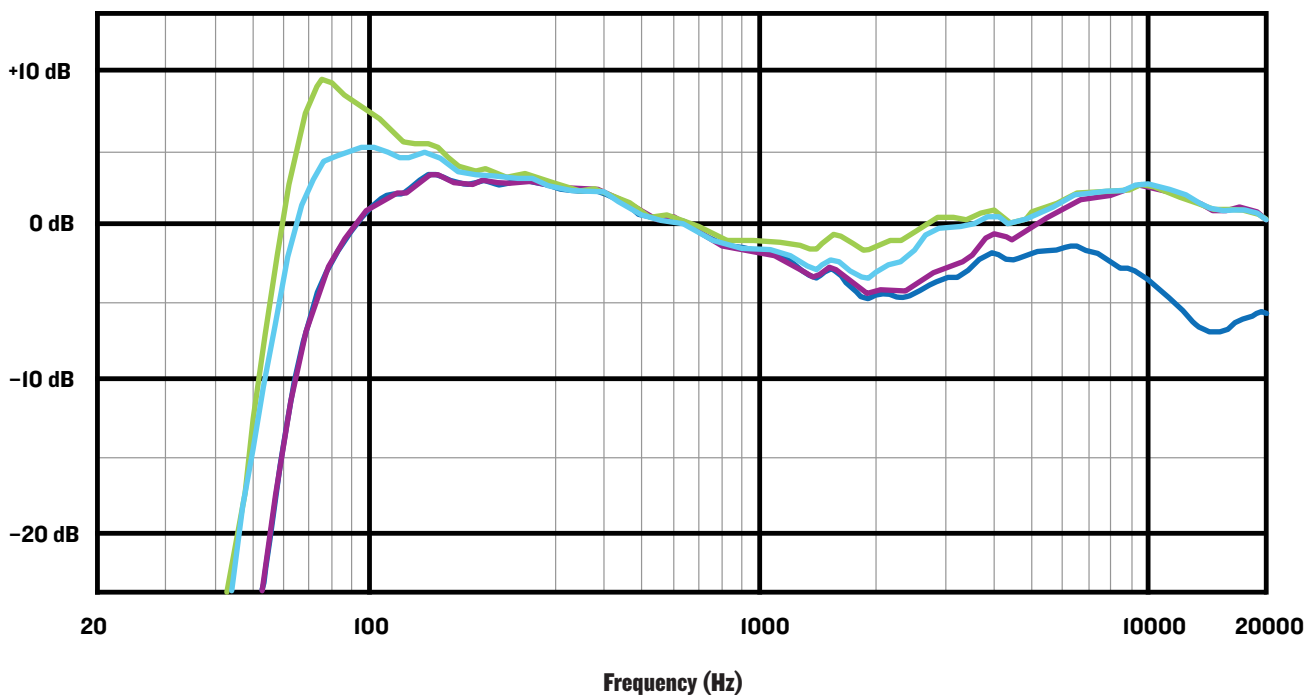

SRM450v3 Loudspeaker Frequency Response

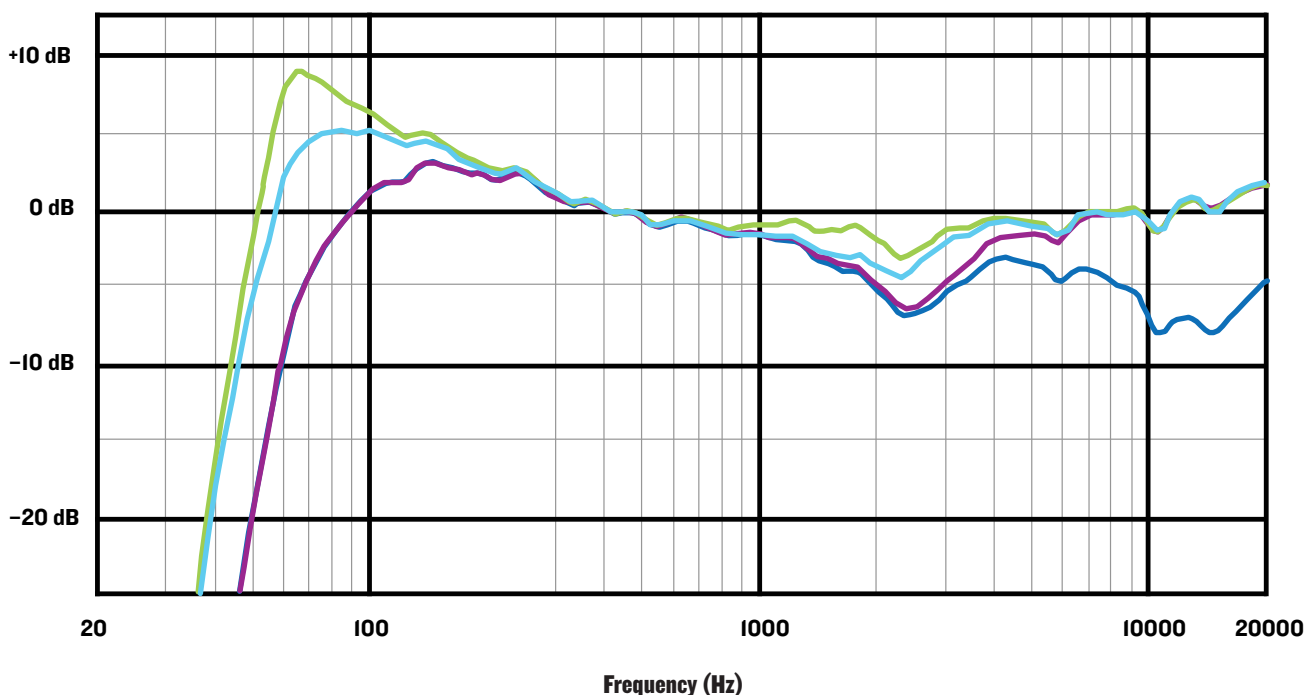

SRM350v3 and SRM450v3 Loudspeaker Block Diagram

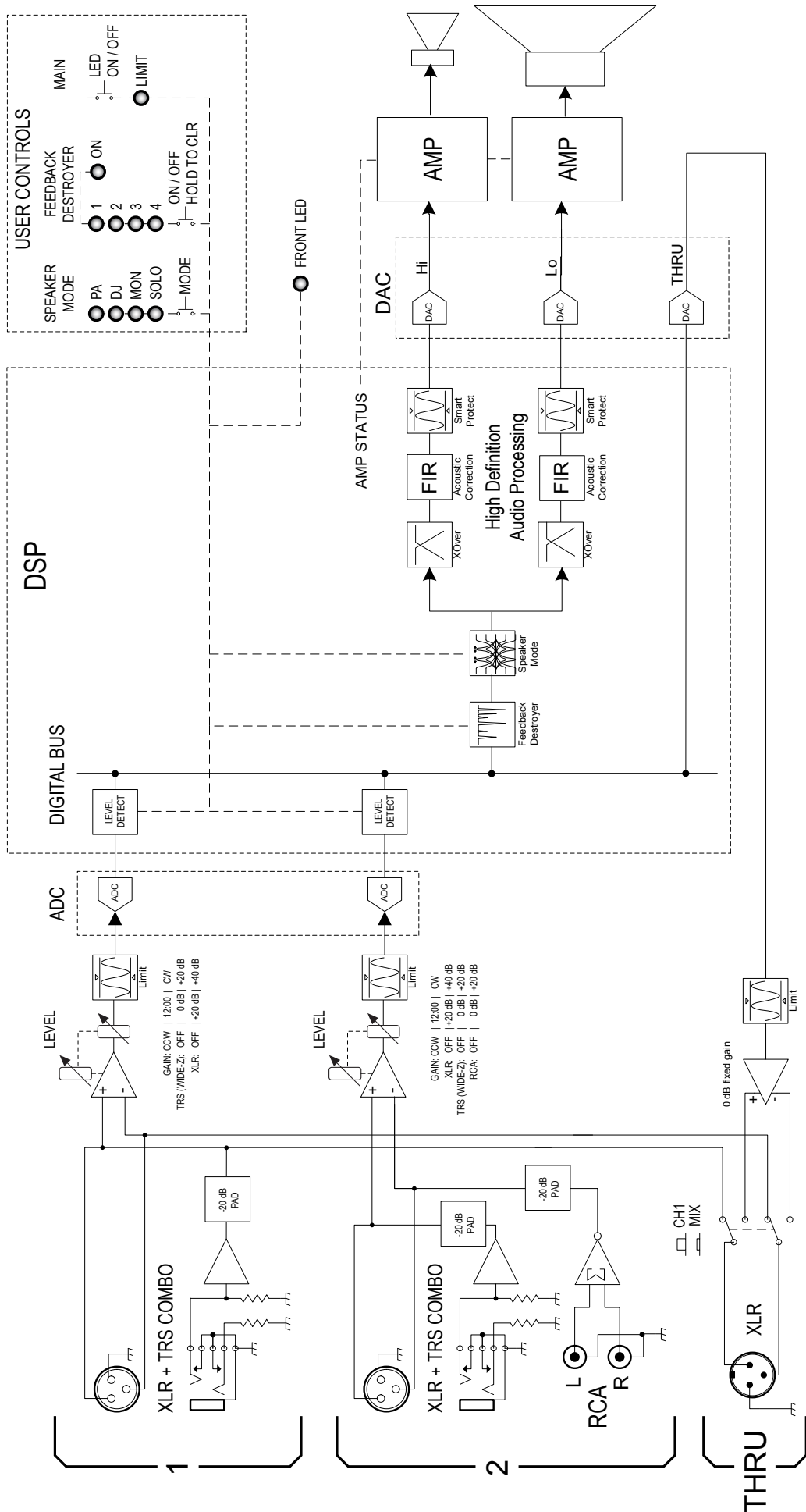

Limited Warranty

Please keep your sales receipt in a safe place.

This Limited Product Warranty ("Product Warranty") is provided by LOUD Technologies Inc. ("LOUD") and is applicable to products purchased in the United States or Canada through a LOUD-authorized reseller or dealer. The Product Warranty will not extend to anyone other than the original purchaser of the product (hereinafter, "Customer," "you" or "your").

For products purchased outside the U.S. or Canada, please visit www.720trees.com to find contact information for your local distributor, and information on any warranty coverage provided by the distributor in your local market.

LOUD warrants to Customer that the product will be free from defects in materials and workmanship under normal use during the Warranty Period. If the product fails to conform to the warranty then LOUD or its authorized service representative will at its option, either repair or replace any such nonconforming product, provided that Customer gives notice of the noncompliance within the Warranty Period to the Company at: www.720trees.com or by calling LOUD technical support at 1.800.898.3211 (toll-free in the U.S. and Canada) during normal business hours Pacific Time, excluding weekends or LOUD holidays. Please retain the original dated sales receipt as evidence of the date of purchase. You will need it to obtain any warranty service.

For full terms and conditions, as well as the specific duration of the Warranty for this product, please visit www.720trees.com.

The Product Warranty, together with your invoice or receipt, and the terms and conditions located at www.720trees.com constitutes the entire agreement, and supersedes any and all prior agreements between LOUD and Customer related to the subject matter hereof. No amendment, modification or waiver of any of the provisions of this Product Warranty will be valid unless set forth in a written instrument signed by the party to be bound thereby.

Need help with your loudspeaker?

- Visit www.720trees.com and click Support to find: FAQs, manuals, addendums, and other documents.
- Email us at: techmail@loudtechinc.com.
- Telephone 1-800-898-3211 to speak with one of our splendid technical support chaps (Monday through Friday, normal business hours, Pacific Time).



**16220 Wood-Red Road NE
Woodinville, WA 98072 • USA
Phone: 425.487.4333
Toll-free: 800.898.3211
Fax: 425.487.4337
www.720trees.com**

Free Manuals Download Website

<http://myh66.com>

<http://usermanuals.us>

<http://www.somanuals.com>

<http://www.4manuals.cc>

<http://www.manual-lib.com>

<http://www.404manual.com>

<http://www.luxmanual.com>

<http://aubethermostatmanual.com>

Golf course search by state

<http://golfingnear.com>

Email search by domain

<http://emailbydomain.com>

Auto manuals search

<http://auto.somanuals.com>

TV manuals search

<http://tv.somanuals.com>