

PROFX²SERIES

PROFESSIONAL EFFECTS MIXERS

OWNER'S MANUAL

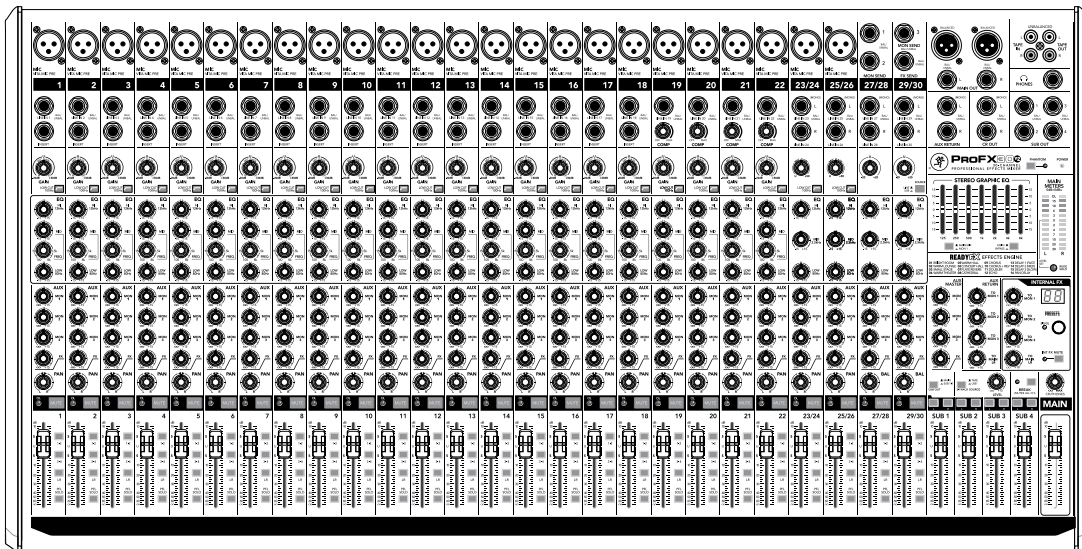
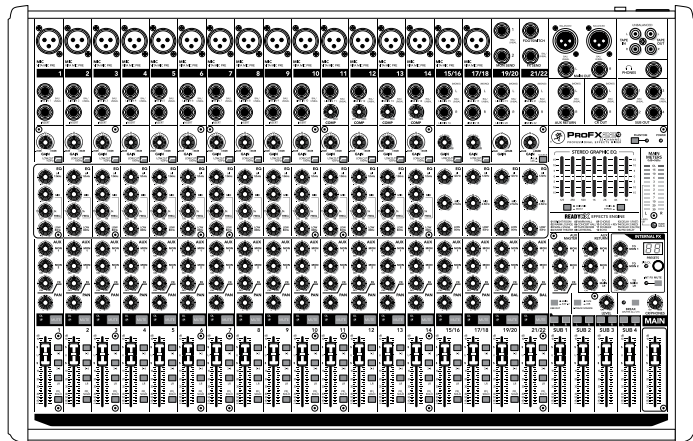
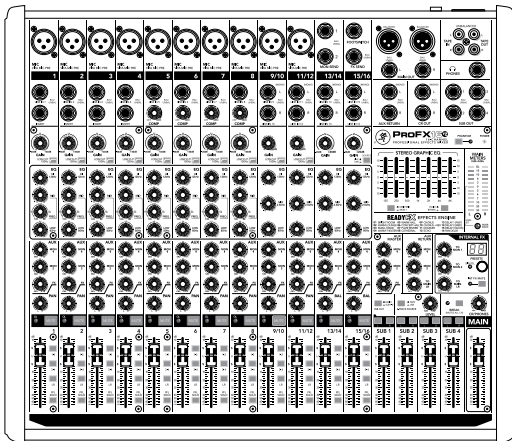
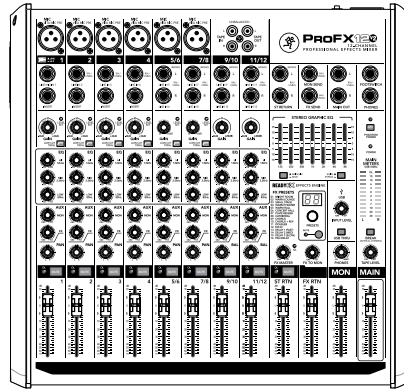
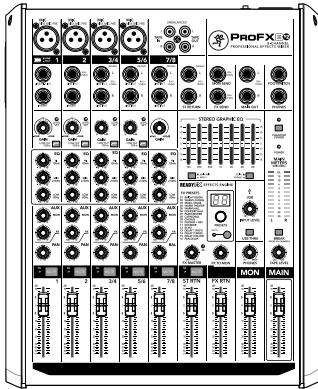

Important Safety Instructions

1. Read these instructions.
2. Keep these instructions.
3. Heed all warnings.
4. Follow all instructions.
5. Do not use this apparatus near water.
6. Clean only with a dry cloth.
7. Do not block any ventilation openings. Install in accordance with the manufacturer's instructions.
8. Do not install near any heat sources such as radiators, heat registers, stoves, or other apparatus (including amplifiers) that produce heat.
9. Do not defeat the safety purpose of the polarized or grounding-type plug. A polarized plug has two blades with one wider than the other. A grounding-type plug has two blades and a third grounding prong. The wide blade or the third prong are provided for your safety. If the provided plug does not fit into your outlet, consult an electrician for replacement of the obsolete outlet.
10. Protect the power cord from being walked on or pinched particularly at plugs, convenience receptacles, and the point where they exit from the apparatus.
11. Only use attachments/accessories specified by the manufacturer.
12. Use only with a cart, stand, tripod, bracket, or table specified by the manufacturer, or sold with the apparatus. When a cart is used, use caution when moving the cart/apparatus combination to avoid injury from tip-over.
13. Unplug this apparatus during lightning storms or when unused for long periods of time.
14. Refer all servicing to qualified service personnel. Servicing is required when the apparatus has been damaged in any way, such as power-supply cord or plug is damaged, liquid has been spilled or objects have fallen into the apparatus, the apparatus has been exposed to rain or moisture, does not operate normally, or has been dropped.
15. This apparatus shall not be exposed to dripping or splashing, and no object filled with liquids, such as vases or beer glasses, shall be placed on the apparatus.
16. Do not overload wall outlets and extension cords as this can result in a risk of fire or electric shock.
17. This apparatus has been designed with Class-I construction and must be connected to a mains socket outlet with a protective earthing connection (the third grounding prong).
18. This apparatus has been equipped with a rocker-style AC mains power switch. This switch is located on the rear panel and should remain readily accessible to the user.
19. The MAINS plug or an appliance coupler is used as the disconnect device, so the disconnect device shall remain readily operable.



20. NOTE: This equipment has been tested and found to comply with the limits for a Class B digital device, pursuant to part 15 of the FCC Rules. These limits are designed to provide reasonable protection against harmful interference in a residential installation. This equipment generates, uses, and can radiate radio frequency energy and, if not installed and used in accordance with the instructions, may cause harmful interference to radio communications. However, there is no guarantee that interference will not occur in a particular installation.

If this equipment does cause harmful interference to radio or television reception, which can be determined by turning the equipment off and on, the user is encouraged to try to correct the interference by one or more of the following measures:

- Reorient or relocate the receiving antenna.
- Increase the separation between the equipment and the receiver.
- Connect the equipment into an outlet on a circuit different from that to which the receiver is connected.
- Consult the dealer or an experienced radio/TV technician for help.

CAUTION: Changes or modifications to this device not expressly approved by LOUD Technologies Inc. could void the user's authority to operate the equipment under FCC rules.

21. This apparatus does not exceed the Class A/Class B (whichever is applicable) limits for radio noise emissions from digital apparatus as set out in the radio interference regulations of the Canadian Department of Communications.

ATTENTION — *Le présent appareil numérique n'émet pas de bruits radioélectriques dépassant les limites applicables aux appareils numériques de class A/de class B (selon le cas) prescrites dans le règlement sur le brouillage radioélectrique édicté par les ministere des communications du Canada.*

22. Exposure to extremely high noise levels may cause permanent hearing loss. Individuals vary considerably in susceptibility to noise-induced hearing loss, but nearly everyone will lose some hearing if exposed to sufficiently intense noise for a period of time. The U.S. Government's Occupational Safety and Health Administration (OSHA) has specified the permissible noise level exposures shown in the following chart.

According to OSHA, any exposure in excess of these permissible limits could result in some hearing loss. To ensure against potentially dangerous exposure to high sound pressure levels, it is recommended that all persons exposed to equipment capable of producing high sound pressure levels use hearing protectors while the equipment is in operation. Ear plugs or protectors in the ear canals or over the ears must be worn when operating the equipment in order to prevent permanent hearing loss if exposure is in excess of the limits set forth here:

Duration, per day in hours	Sound Level dBA, Slow Response	Typical Example
8	90	Duo in small club
6	92	
4	95	Subway Train
3	97	
2	100	Very loud classical music
1.5	102	
1	105	Matt screaming at Troy about deadlines
0.5	110	
0.25 or less	115	Loudest parts at a rock concert

CAUTION

RISK OF ELECTRIC SHOCK! DO NOT OPEN!

CAUTION: TO REDUCE THE RISK OF ELECTRIC SHOCK DO NOT REMOVE COVER (OR BACK). NO USER-SERVICEABLE PARTS INSIDE. REFER SERVICING TO QUALIFIED PERSONNEL.

The lightning flash with arrowhead symbol within an equilateral triangle is intended to alert the user to the presence of uninsulated "dangerous voltage" within the product's enclosure, that may be of significant magnitude to constitute a risk of electric shock to persons.

The exclamation point within an equilateral triangle is intended to alert the user of the presence of important operating and maintaining (servicing) instructions in the literature accompanying the appliance.

WARNING — To reduce the risk of fire or electric shock, do not expose this apparatus to rain or moisture.

Laitte on liitettävä suojakoskettimilla varustettuun pistorasiaan.

Apparatet må tilkoples jordet stikkontakt.

Apparaten skall anslutas till jordat uttag.

Correct disposal of this product: This symbol indicates that this product should not be disposed of with your household waste, according to the WEEE directive (2012/19/EU) and your national law. This product should be handed over to an authorized collection site for recycling waste electrical and electronic equipment (EEE). Improper handling of this type of waste could have a possible negative impact on the environment and human health due to potentially hazardous substances that are generally associated with EEE. At the same time, your cooperation in the correct disposal of this product will contribute to the effective usage of natural resources. For more information about where you can drop off your waste equipment for recycling, please contact your local city office, waste authority, or your household waste disposal service.

Contents

Important Safety Instructions	2
Contents / Features	3
Introduction / Getting Started	4
Hookup Diagrams.....	5
1. Power Connection / 2. Power Switch.....	7
3. USB Input / Output.....	7
4. Main L/R XLR Outputs / 5. Mic Inputs	8
6. Line / Hi-Z Switch	9
7. Line Inputs / Hi-Z Input	9
8. Stereo Line Inputs / 9. Insert	10
10. Gain / 11. Level Set LED.....	11
12. Low Cut Switch.....	11
13. Hi EQ / 14. Mid EQ / 15. Freq.....	12
16. Mid EQ / 17. Low EQ / 18. Aux Mon.....	12
19. Aux FX / 20. Pan / Bal / 21. OL LED.....	13
22. Mute Switch / 23. Assign Switches	13
24. PFL Solo Switch / 25. Channel Fader.....	14
26. Compressor	14
27. USB Switch.....	15
28. Mon Send / 29. FX Send.....	16
30. FX Footswitch.....	16
31. Stereo (Aux) Return L/R.....	16
32. Main Out L/R / 33. CR Out L/R	17
34. Sub Out 1-4 / 35. Phones.....	17
36. Tape Inputs / Outputs.....	17
37. 48V Phantom Power Switch.....	18
38. Power LED / 39. Stereo Graphic EQ.....	18
40. Main Mix / Mon 1 Switch.....	18
41. EQ In / Bypass Switch / 42. Main Meters .	18
43. Rude Solo LED.....	19
44. Aux Masters / 45. Stereo (Aux) Returns ...	20
46. Internal FX / 47. Preset Selector	20
48. Preset Display / 49. Sig / OL LED	20
50. Int FX Mute Switch and LED.....	20
51. Mute and OL LED	21
52. USB Input Level / 53. USB Thru.....	22
54. USB Out Switch	22
55. 2-Track Return Tape / USB Switch	22
56. 2-Track Return Level / 57. Tape Level.....	22
58. Break Switch and LED.....	22
59. CR / Phones / 60. Sub Assigns Switches ...	23
61. Sub 1-4 Faders / 62. Main Mix.....	23
Appendix A: Service Information	24
Appendix B: Technical Information	26
Appendix C: Table of Effects Presets.....	38
Limited Warranty.....	39



Like us



Follow us



Watch our dang videos

Features

Unmatched Sound Quality

- Extremely low-noise Vita™ mic preamps designed to add life to any input
- All-new ReadyFX™ effects engine with 16 great-sounding effects like reverbs, delays and choruses
- Single-knob channel compression for smooth, even dynamic control¹

No-Compromise Live Mixing Toolkit

- Graphic EQ for tuning mains or monitors
- Built-in USB interface to record the show or provide music playback²
- 4 flexible subgroups for professional mix management¹
- Aux output(s) perfect for driving a monitor mix, fill speakers and more
- Additional stereo channels
- Extra stereo/aux return for external effects or stereo playback devices²
- High-headroom line level inputs
- Individual channel mutes and overload indication²
- Channel inserts for connecting outboard processing²
- EQ on all channels
- 60mm faders²
- Directly connect guitar, bass and other instruments via Hi-Z input³
- 100Hz low-cut filter and 48V phantom power on all mic channels
- Stereo RCA tape I/O with input level control
- Headphone output with separate level control³
- Control room / headphone outs with level control¹
- Balanced XLR and/or balanced/unbalanced 1/4-inch main outputs
- FX mute with remote control via footswitch⁴
- Break switch mutes all channels for music playback between sets²

No-Hassle USB Recording/Playback²

- Built in USB recording interface with simple setup via Mac or PC
 - Choose to record subgroups 1/2 or main L/R mix¹
 - Separate USB input level control to mains²
 - USB routable to full-featured channel strip¹
- Great for live recording and perfect for home studios
- Stream playback music for live or studio applications
- Includes user-friendly Tracktion® recording software

Rugged, Roadworthy Design

- Legendary “Built-Like-A-Tank” design
- Solid steel chassis protects your investment
- Tough ABS side protection
- Robust internal multi-voltage power supply²

¹ Available on ProFX16v2, ProFX22v2, ProFX30v2.

² Available on ProFX8v2, ProFX12v2, ProFX16v2, ProFX22v2, ProFX30v2.

³ Available on ProFX8v2, ProFX12v2.

⁴ Available on ProFX8v2, ProFX12v2, ProFX16v2, ProFX22v2.

Part No. SW1074 Rev. A 04/15

©2015 LOUD Technologies Inc. All Rights Reserved.

Introduction

Our ProFXv2 Series mixers provide a comprehensive live sound solution, with models from 4- to 30-channels, covering a huge range of applications.

Delivering unmatched sound quality, ProFXv2 features all-new Vita™ preamps, which are virtually noiseless and designed specifically for the highly-dynamic world of live sound.

ProFXv2 also includes the immensely powerful new ReadyFX™ effect engine, harnessing floating-point DSP to deliver 16 rich effects that elevate any performance.

The ProFXv2 no-compromise live sound toolkit includes a room-shaping GEQ, flexible I/O and a built-in USB interface for hassle-free recording/playback.

With a rugged steel chassis and unmatched sonic performance, ProFXv2 is truly the life of your live mix.

How to Use This Manual:

After this introduction, a getting started guide will help you get things set up fast. The hookup diagrams show some typical setups, while the remaining sections provide details of the ProFXv2 Series mixers.



This icon marks information that is critically important or unique to ProFXv2. For your own good, read and remember them.



This icon leads you to in-depth explanations of features and practical tips. They usually have some valuable nuggets of information.

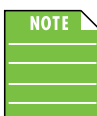

This icon draws attention to certain features and functions relating to the usage of ProFXv2.

Things to Remember:

- Never listen to loud music for prolonged periods. Please see the Safety Instructions on page 2 for information on hearing protection.
- Save the shipping box and packing materials! You may need them someday. Besides, the cats will love playing in them and jumping out at you unexpectedly. Remember to pretend like you are surprised!
- Save your sales receipt in a safe place.

Getting Started

The following steps will help you set up the ProFXv2 mixer quickly.

1. Turn down all knobs except the channel EQ and pan knobs, and set all the faders fully down.
2. Set all channel EQ knobs, pan knobs, and the graphic EQ sliders at their center detent.
3. Set all buttons to the “out” position.
4. Plug signal sources into the mixer, such as:
 - Microphones plugged into the mic inputs. Engage phantom power if your mics need it. Check the mic's user manual to be sure.
 - Line-level sources such as keyboards, drum machines, or CD players plugged into the line-level inputs.
5. Connect cords from the main outs to your powered speakers or amplifier.
6. Plug in the mixer's power cord to a live AC outlet and turn on the mixer.
7. If you have powered speakers, turn them on. Otherwise, hook up your passive speakers to your amp with speaker cables, and turn it on. Adjust your powered speaker or amplifier level controls to however the manufacturer recommends.
8. Plug something into an input. This could be an instrument, you singing or speaking, or a line level source such as a keyboard or CD player.
9. Engage the channel's PFL Solo switch [ProFX16v2, ProFX22v2, ProFX30v2] to view the input level via the main meters.
10. Be sure that the volume of the input is the same as it would be during normal use, or you may have to readjust the gain in the middle of a set. You can listen with headphones if you carefully turn up the channel fader and headphones level a little.
11. The mono channel gain affects the mic and the line inputs. The stereo channel gain adjusts the stereo line inputs. Adjust as desired, and make sure that the OL LED does not come on during the loudest passages.



There are hybrid channels that have both mono mic and stereo line inputs. In these channels, the gain control affects only the mic gain.

12. To get sound out of the speakers and into a waiting world, engage a channel's L-R assign switch [ProFX16v2, ProFX22v2, ProFX30v2] turn up that channel's fader to the “U” (unity gain) position, and slowly bring up the main fader to a comfortable listening level.
13. Repeat steps 8 to 12 for the other channels.

Hookup Diagrams

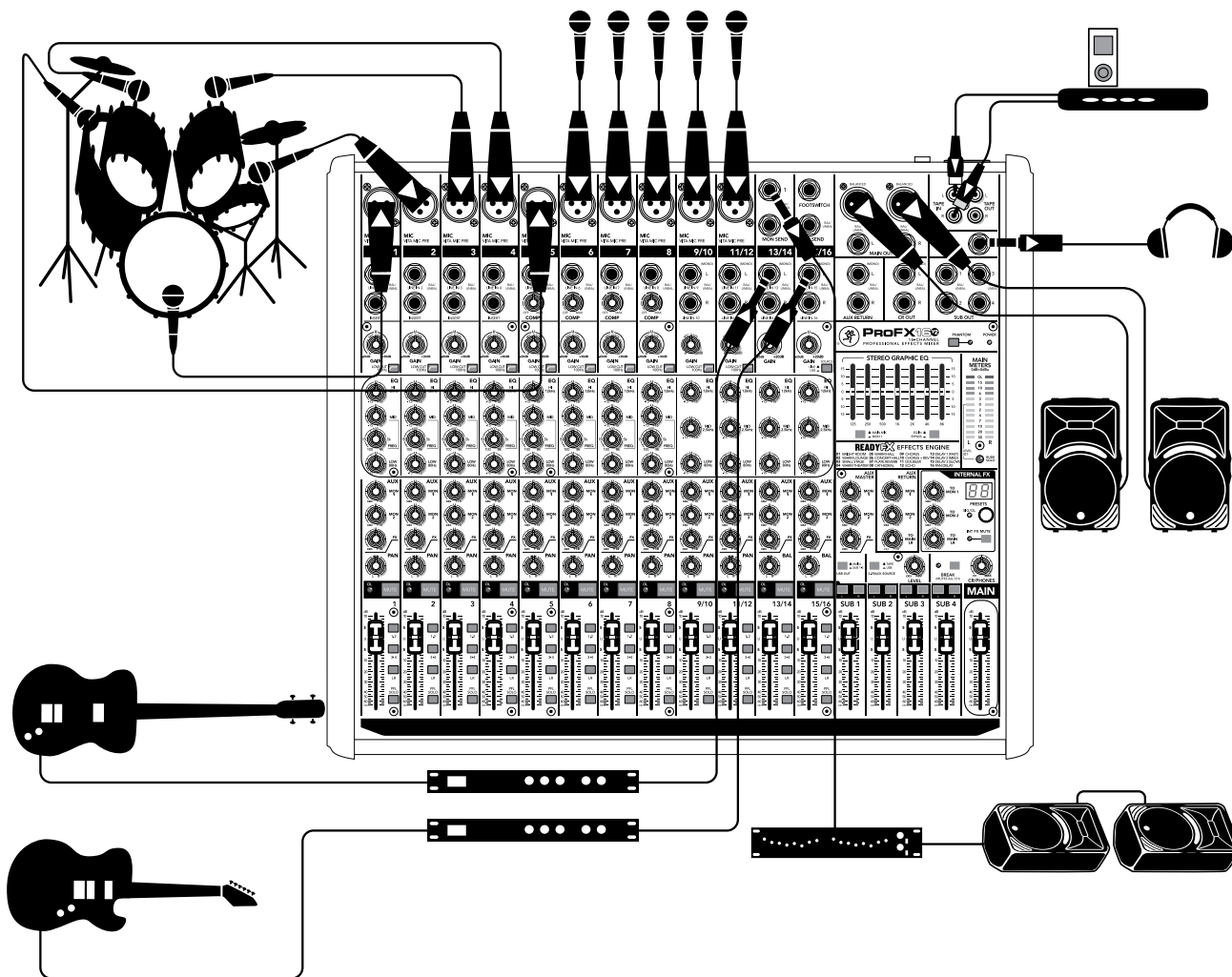

This diagram shows a mic'd up drum kit utilizing the first five channels of the mixer. Microphones are connected to the next five channels for lead and background vocals. A bass and guitar are attached to the next two channels' line-level inputs, each via a mono effects processor. An iPod docking station is attached to the stereo tape inputs.

SRM450v3 powered speakers are connected to the left and right main output. Two of these speakers are also set up as stage monitors and connect to the mixer's monitor output via a graphic EQ. The aux mon controls of each channel allow you to create a stage monitor mix as desired. Headphones are used for monitoring and a footswitch allows you to mute/unmute the internal effects as desired.

A laptop connects to the USB port on the rear panel of the mixer and allows the 2-channel main mix of the performance to be recorded to a DAW. Two channels of audio can also play from your computer to the main mix.

Typical Live Sound System

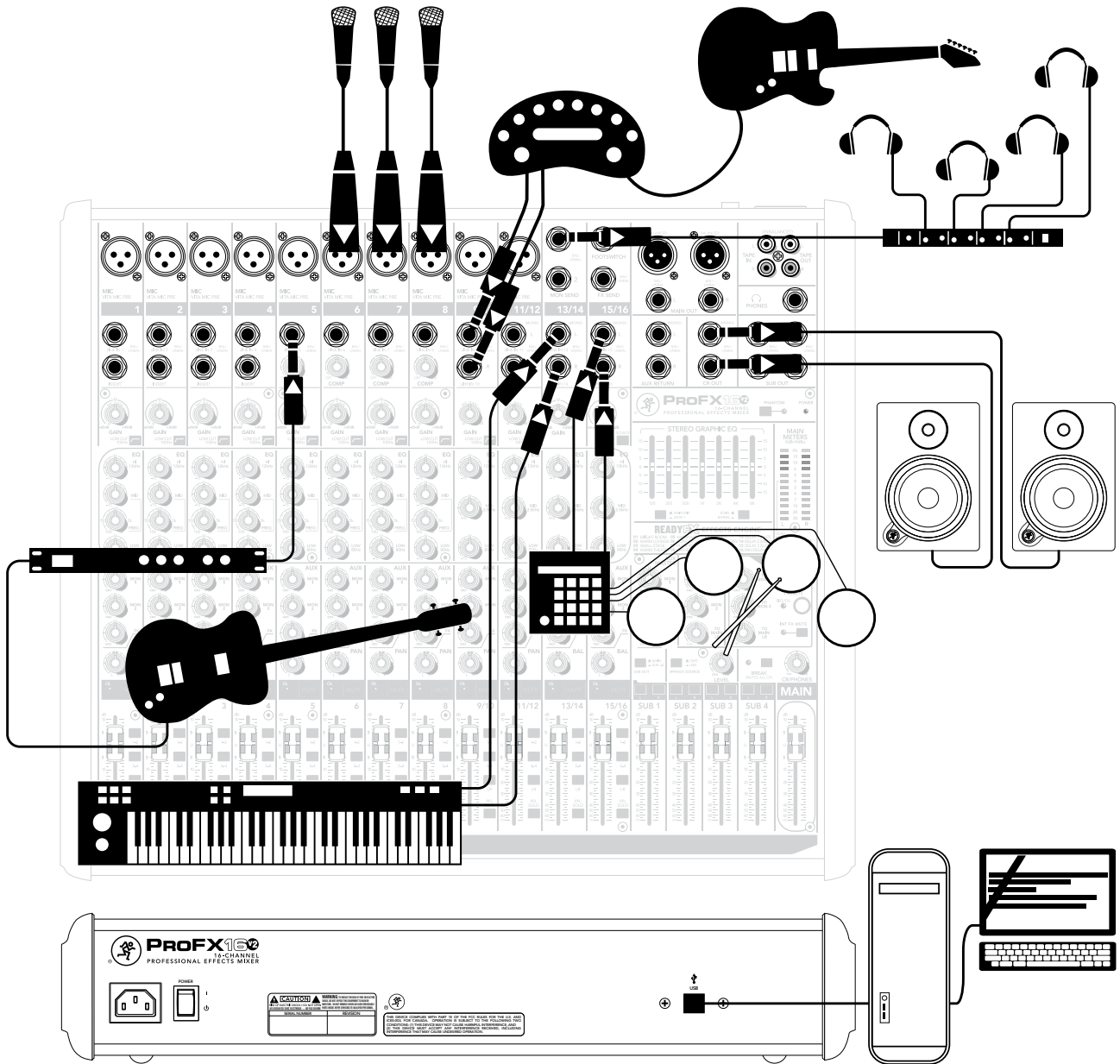

This diagram shows a bass and effects processor attached to the channel 5 line-level input, microphones attached to channels 6, 7 and 8, a guitar amplifier modeler connected to the line-level inputs of channel 9/10, a keyboard connected to channel 13/14 and an electronic drum kit attached to channel 15/16.

MR8mk3 powered reference monitors are connected to the left and right control room outputs for careful and accurate monitoring of the performance. Headphones connected to mon send 1 via a headphone amp are available for the talent to utilize when tracking.

A desktop computer connects to the USB port to record the 2-channel main mix to the DAW, as well as play back two channels from the DAW.

Typical Recording System

ProFXv2 Rear Panel Features

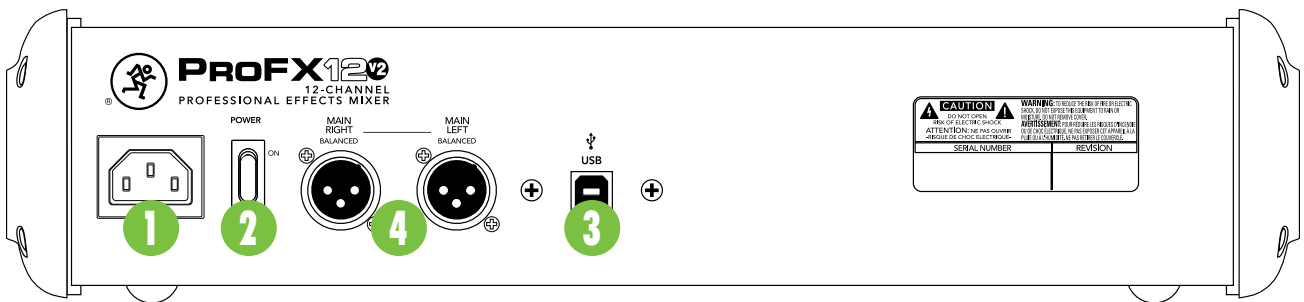

Connections

1. Power Connection

This is a standard 3-prong IEC power connector. Connect the detachable linecord (included in the box with your mixer) to the power receptacle, and plug the other end of the linecord into an AC outlet.

ProFXv2 Series mixers have a universal power supply that accepts any AC voltage ranging from 100 VAC to 240 VAC. No need for voltage select switches. It will work virtually anywhere in the world. That's why we call it a "Planet-Earth" power supply! It is less susceptible to voltage sags or spikes, compared to conventional power supplies, and provides greater electromagnetic isolation and better protection against AC line noise.



Disconnecting the plug's ground pin is dangerous. Don't do it.

2. Power Switch

Press the top of this rocker switch inwards to turn on the mixer. The front panel power LED will glow with happiness...or at least it will if you have the mixer plugged into a suitable live AC mains supply.

Press the bottom of this switch to put the mixer into standby mode. It will not function, but some circuits are still live. To remove AC power, either turn off the AC mains supply, or unplug the power cord from the mixer and the AC mains supply.



As a general guide, you should turn on the mixer first, before any external power amplifiers or powered speakers, and turn it off last. This will reduce the possibility of any turn-on, or turn-off thumps in your speakers.

3. USB Input / Output

The built-in USB interface allows for some powerful and flexible routing. It is a 2x2 interface allowing you to record two streams from the mixer, or to input stereo playback from a computer and route it to nearly any output or pair of outputs on the mixer [ProFX16v2, ProFX22v2 and ProFX30v2].



The ProFX8v2 and ProFX12v2 USB return only goes to main L/R via the USB input level control.

The USB routing capabilities are as follows:

USB input TO the mixer – playback:

(1) Stereo channel 15/16 (on the ProFX16v2), 21/22 (on the ProFX22v2) and 29/30 (on the ProFX30v2) features a USB button, so one may route computer output (such as iTunes®) down the last stereo channel of the board. This stereo signal may then be EQ'd, sent to auxiliaries (i.e. to feed monitors, headphones or effects) and is routable to mains and/or subgroups via the fader routing features that are available on all other channels. In short, this signal may be sent to nearly any desired output or pair of outputs. Additionally, the gain knob at the top of this channel strip adjusts the USB input level to the mixer to achieve an optimal signal level.

(2) The 2-Track Return section [ProFX16v2, ProFX22v2, ProFX30v2] features a switch to select either a "Tape" source (such as an iPod® connected via RCA cables) or the USB signal from a computer (playing Windows Media Player® files, for example) may be routed to the main bus. This section also features an input level adjustment for fading house music up and down between bands, at a house of worship, or any other event where this may be necessary.

USB output FROM the mixer – recording, etc:

In the USB out section [ProFX16v2, ProFX22v2, ProFX30v2] you may select either the main mix (disengaged) or subgroups 1-2 (engaged) from the conveniently titled USB out switch. The USB tap points for the subgroups are pre-fader and signals will show up on the DAW dependent upon how they are panned on the channels.

In other words, if subgroups 1 and 2 are used to submix drums and those drums have a stereo image (e.g. overheads and toms channels are panned according to desire), this stereo image is retained in the DAW inputs. Any adjustments made to the subgroup drum levels during the show only pertain to the live show itself; recording levels are not adjusted in the DAW unless they are adjusted on the channels.

Likewise, it is possible to record the main mix to take home a copy of the live show. These levels are also pre-main fader. Therefore, levels may be mixed up or down in the DAW later depending on the needs of the recording versus the live show. The end result is that fade-ins and/or fade-outs made during the show do not affect recorded levels.

4. Main L/R XLR Outputs

The male XLR connectors provide a balanced line-level signal that represents the end of the mixer chain, where the fully mixed stereo signal enters the real world. Connect these to the left and right inputs of your main power amplifiers, powered speakers, or serial effects processor (like a graphic equalizer or compressor/limiter).

They are wired as follows, according to standards specified by the AES (Audio Engineering Society):

XLR Balanced Wiring:

- Pin 1 = Shield (ground)
- Pin 2 = Positive (+ or hot)
- Pin 3 = Negative (- or cold)

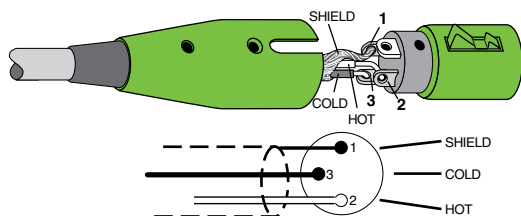

NOTE The main L/R XLR outputs are located on the rear panel of the ProFX8v2 and ProFX12v2 and on the front panel of the ProFX16v2, ProFX22v2, and ProFX30v2.

NOTE The XLR outputs are 6 dB hotter than the TRS outputs.

ProFXv2 Front Panel Features

Connections and Channel Strip

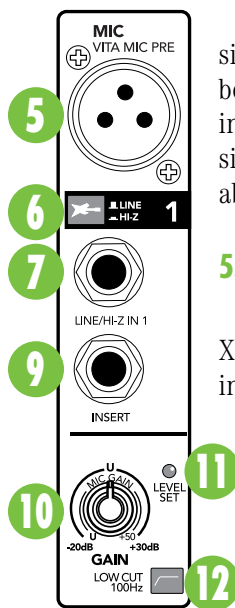

The vertical channel strips look very similar, and have only a few differences between them. Each channel works independently, and just controls the signals plugged into the inputs directly above them.

5. Mic Inputs

ProFXv2 mixers use 3-pin female XLR connectors on all microphone inputs, with pin 1 wired to the grounded (earthed) shield, pin 2 wired to the high (hot or positive polarity) side of the audio signal and pin 3 wired to the low (cold or negative polarity) side of the signal.

ProFX8v2
ProFX12v2

These female XLR connectors accept balanced mics or line level inputs from almost any type of source.

The Vita mic preamps feature higher fidelity and headroom rivaling any standalone mic preamp on the market today.

We use phantom-powered, balanced inputs just like the big mega-consoles, for exactly the same reason: This kind of circuit is excellent at rejecting hum and noise.

Professional ribbon, dynamic, and condenser mics all sound excellent through these inputs. The mic/line inputs will handle any kind of level you can toss at them, without overloading.

Microphone-level signals are passed through the mixer's splendid microphone preamplifiers to become line-level signals.

They are wired as follows, according to standards specified by the AES (Audio Engineering Society):

XLR Balanced Wiring:

- Pin 1 = Shield (ground)
- Pin 2 = Positive (+ or hot)
- Pin 3 = Negative (- or cold)

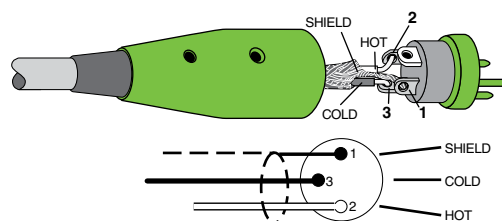

Phantom Power

Most modern professional condenser mics require 48V phantom power, which lets the mixer send low-current DC voltage to the mic's electronics through the same wires that carry audio. (Semi-pro condenser mics often have batteries to accomplish the same thing.) "Phantom" owes its name to an ability to be "unseen" by dynamic mics (Shure SM57/SM58, for instance), which don't need external power and aren't affected by it anyway.

NOTE The ProFX mixer's phantom power is globally controlled by the phantom power switch (meaning that phantom power for all mic inputs is turned on and off together.)

VERY IMPORTANT Never plug single-ended (unbalanced) microphones or ribbon microphones into the mic input jacks if phantom power is on.

Do not plug instrument outputs into the mic input jacks with phantom power on unless you know for certain it is safe to do so.

6. Line / Hi-Z Switch [ProFX8v2 / ProFX12v2]

To connect a guitar directly to the mixer without using a DI Box, press this switch in first; then connect the output from the guitar to channel 1's 1/4" TRS input. The input impedance is optimized for direct connection and high-frequency fidelity is assured.

In the out position, channel 1's 1/4" TRS input becomes a line input just like the other mono line inputs.

To use guitars or other instruments on other channels, you will need to use an external DI box first. Without the DI box – or if this switch is not pressed in – guitars may sound dull and muddy.

7. Line Inputs Hi-Z Input (Channel 1 Only) [ProFX8v2 / ProFX12v2]

In addition to accepting balanced mic or line-level signals using an XLR connector, ProFXv2 Series mixers may also accept 1/4" line-level signals driven by balanced or unbalanced sources. These 1/4" jacks share circuitry (but not phantom power) with the mic preamps.

To connect balanced lines to these inputs, use a 1/4" Tip-Ring-Sleeve (TRS) plug. "TRS" stands for Tip-Ring-Sleeve, the three connection points available on a stereo 1/4" or balanced phone jack or plug.

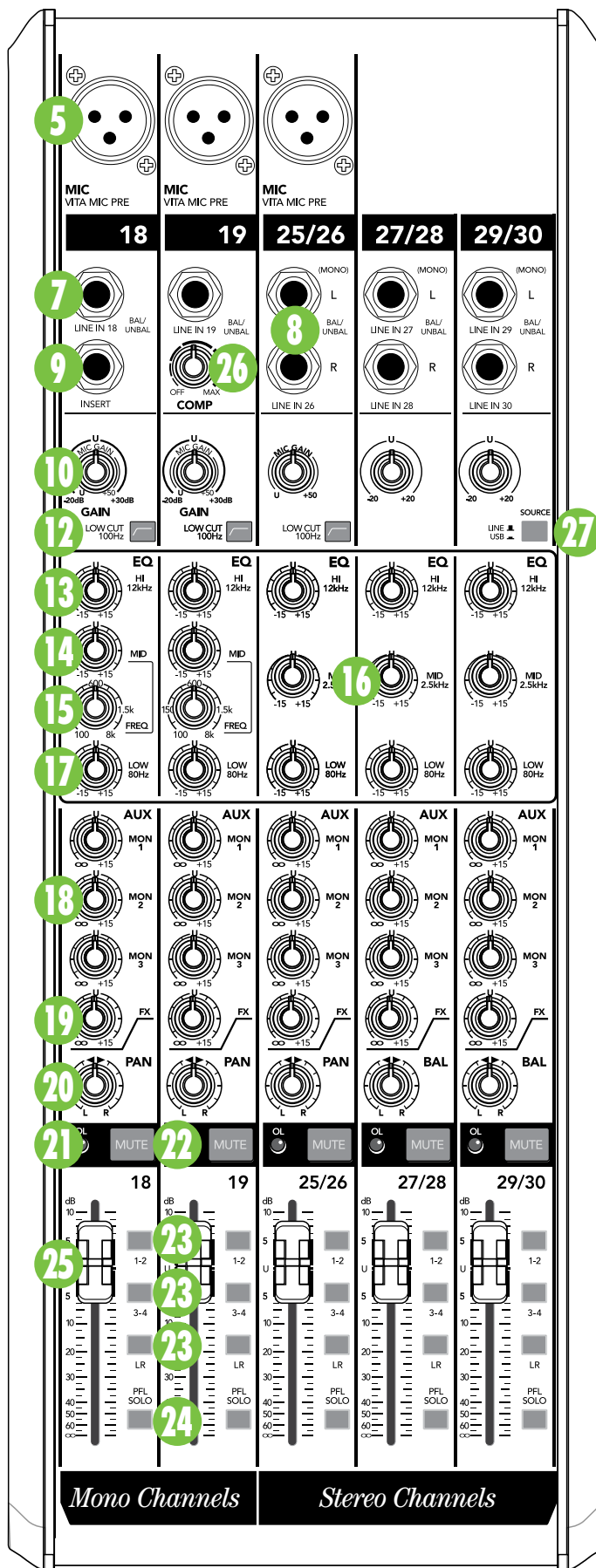

- | | |
|----------------------------|-----------------------------|
| Channels 1-2 on ProFX8v2 | Channels 3-8 on ProFX8v2 |
| Channels 1-4 on ProFX12v2 | Channels 5-12 on ProFX12v2 |
| Channels 1-8 on ProFX16v2 | Channels 9-16 on ProFX16v2 |
| Channels 1-14 on ProFX22v2 | Channels 15-22 on ProFX22v2 |
| Channels 1-22 on ProFX30v2 | Channels 23-30 on ProFX30v2 |

TRS jacks and plugs are used for balanced signals and stereo headphones and are wired as follows according to standards specified by the AES (Audio Engineering Society):

1/4" TRS Balanced Mono Wiring:

- Sleeve = Shield (ground)
- Tip = Positive (+ or hot)
- Ring = Negative (- or cold)

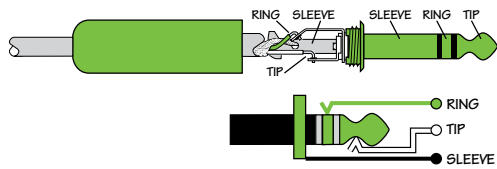

To connect an unbalanced line to this input, use a 1/4" mono (TS) phone plug or instrument cable. They are wired as follows, according to standards specified by the AES (Audio Engineering Society):

1/4" TS Unbalanced Mono Wiring:

- Sleeve = Shield (ground)
- Tip = Positive (+ or hot)

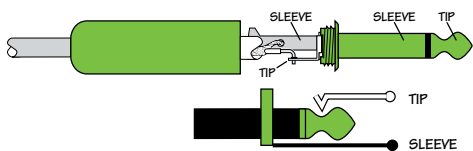

The channel 1 line-level input on the ProFX8v2 and ProFX12v2 may also accept instrument-level signals if the hi-z switch is engaged. This allows you to connect guitars directly into channel 1 without the need for a DI box.

8. Stereo Line Inputs

The stereo line inputs are designed for 1/4" TRS balanced or 1/4" TS unbalanced signals. They may accept any line-level instrument, effects device, CD player, etc.

Level control is available -20 dB to +20 dB. If you are connecting a mono source, use the left (mono) input, and the mono signals will appear on both sides of the main mix.

The first two stereo channels of each ProFXv2 Series mixer are hybrid channels, each with a mic input XLR jack and low cut switch. Here the gain control only affects the mic input.

Hybrid Channels:

- ProFX8v2 – Channels 3/4 and 5/6
- ProFX12v2 – Channels 5/6 and 7/8
- ProFX16v2 – Channels 9/10 and 11/12
- ProFX22v2 – Channels 15/16 and 17/18
- ProFX30v2 – Channels 23/24 and 25/26

9. Insert

These unbalanced 1/4" jacks are for connecting serial effects processors such as compressors, equalizers, de-essers, or filters.

The insert point is after the gain control and low cut filter, but before the channel's EQ and level. The channel signal can go out of the insert jack to an external device, be processed and come back in on the same insert jack.

To do this requires a standard insert cable that must be wired thusly:

- Tip = send (output to effects device)
- Ring = return (input from effects device)
- Sleeve = common ground

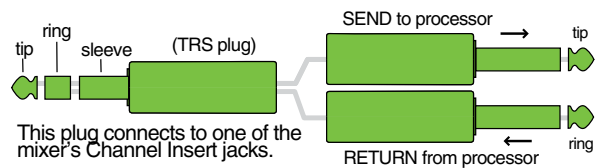

Insert jacks may be used as channel direct outputs; post-gain, and pre-EQ. If you insert a TS (mono) 1/4" plug only partially (to the first click) into an insert jack, the plug will not activate the jack switch and will not open the insert loop in the circuit (thereby allowing the channel signal to continue on its merry way through the mixer).

This allows you to tap out the channel signal without interrupting normal operation.

If you push the 1/4" TS plug in to the second click, you will open the jack switch and create a direct out, which does interrupt the signal in that channel. See illustration below.



Do not overload or short-circuit the signal you are tapping from the mixer. That will affect the internal signal.

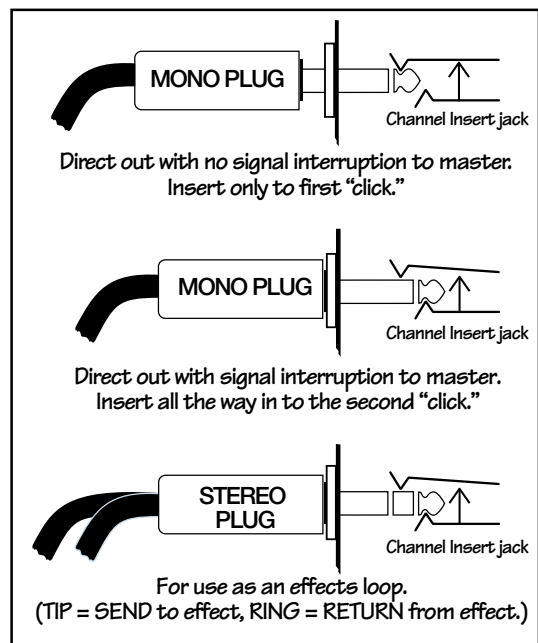

“U” like Unity gain

ProFXv2 Series mixers have a “U” symbol on almost every level control. It stands for “unity gain,” meaning no change in signal level. The labels on the controls are measured in decibels (dB), so you’ll know what you’re doing level-wise if you choose to change a control’s settings.

10. Gain

If you haven’t already, please read the "Getting Started" section on page 4. Setting the gain correctly will ensure that the preamplifier’s gain is not too high, where distortion could occur, and not too low, where the quieter, exquisitely-delicate passages might be lost in background noise.

The gain knobs adjust the input sensitivity of the mic and line inputs. This allows signals from the outside world to be adjusted to run through each channel at optimal internal operating levels.



For mono channels (mic input with a mono line input), the gain knob adjusts the input sensitivity of the mic and line inputs.

If the signal originates through the mic XLR jack, there will be 0 dB of gain with the knob fully down, ramping to 50 dB of gain fully up.

Through the 1/4" mono line inputs, there is 20 dB of attenuation fully down and 30 dB of gain fully up, with unity gain “U” at 12:00.

This 20 dB of attenuation can be very handy when you are inserting a hot signal, or when you want to add EQ gain, or both. Without this “virtual pad,” there is more chance of channel clipping.



For hybrid channels (mic input and stereo line input), the gain control just affects the microphone input.

Hybrid Channels:

- ProFX8v2 – Channels 3/4 and 5/6
- ProFX12v2 – Channels 5/6 and 7/8
- ProFX16v2 – Channels 9/10 and 11/12
- ProFX22v2 – Channels 15/16 and 17/18
- ProFX30v2 – Channels 23/24 and 25/26

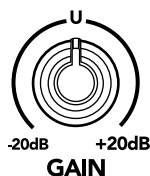

For stereo channels (no mic input) the gain control affects the line-level inputs, with 20 dB of gain, and 20 dB of attenuation.

Stereo Channels:

- ProFX8v2 – Channels 7/8
- ProFX12v2 – Channels 9/10 and 11/12
- ProFX16v2 – Channels 13/14 and 15/16
- ProFX22v2 – Channels 19/20 and 21/22
- ProFX30v2 – Channels 27/28 and 29/30

11. Level Set LED [ProFX8v2 / ProFX12v2]

These LEDs are used with the gain control to set the channel preamplifier gain just right for each source.

If one or more channels are distorting, check the level set LEDs. If they are on continuously, turn down the gain.

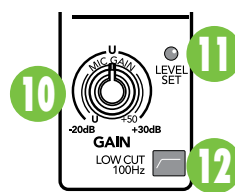

ProFX8v2
ProFX12v2

12. Low Cut Switch

All mono channels have a low-cut switch (often referred to as a high-pass filter) that cuts bass frequencies below 100 Hz at a rate of 18 dB per octave.

We recommend that you use low-cut on every microphone application except kick drum, bass guitar, or bassy synth patches. These aside, there isn’t much down there that you want to hear, and filtering it out makes the low stuff you do want much more crisp and tasty. Not only that, but low-cut can help reduce the possibility of feedback in live situations, and it helps to conserve amplifier power.



Another way to consider low-cut’s function is that it actually adds flexibility during live performances. With the addition of low-cut, you can safely use low equalization on vocals. Many times, bass shelving EQ can really benefit voices. Trouble is, adding low EQ also boosts stage rumble, mic handling clunks and breath pops from way-down low. Applying low-cut removes all those problems, so you can add low EQ without blowing the woofers.

Channel Equalization (EQ)

All ProFXv2 mono channels – except for the ProFX4v2, which is covered in its own owner's manual – have 3-band EQ with shelving hi, peaking mid with adjustable mid frequency [ProFX16v2, ProFX22v2, ProFX30v2] and shelving low. The stereo channels have a peaking mid EQ control in addition to the shelving hi and shelving low EQ controls.

Shelving means that the circuitry boosts or cuts all frequencies past the specified frequency. For example, the low EQ boosts bass frequencies below 80 Hz and continuing down to the lowest note you never heard. Peaking means that certain frequencies form a “hill” around the center frequency.



With too much EQ, you can really upset things. We've designed a lot of boost and cut into each equalizer circuit because we know that everyone will occasionally need that. But if you max the EQ on every channel, you'll get mix mush. Equalize subtly and use the left sides of the knobs (cut), as well as the right (boost). If you find yourself repeatedly using a lot of boost or cut, consider altering the sound source, such as placing a mic differently, trying a different kind of mic, a different vocalist, changing the strings, or gargling.

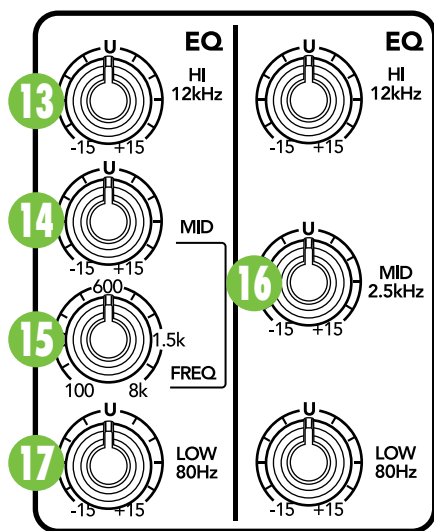

13. Hi EQ

The hi EQ provides up to 15 dB of boost or cut above 12 kHz, and it is also flat (no boost or cut) at the detent. Use it to add sizzle to cymbals, an overall sense of transparency, or an edge to keyboards, vocals, guitar and bacon frying. Turn it down a little to reduce sibilance or to mask tape hiss.

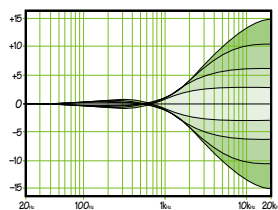

14. Mid EQ

15. Freq [ProFX16v2, ProFX22v2, ProFX30v2]

The mono channels employ a semi-parametric mid-sweep EQ. The gain (up to 15 dB of boost or cut) is set via the mid EQ, and then “aimed” at a specific frequency, from 100 Hz to 8 kHz, via the freq control.

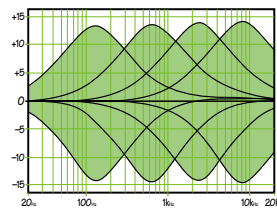

16. Mid EQ

Short for “midrange,” this knob provides up to 15 dB of boost or cut, centered at 2.5 kHz, also flat at the center detent. Midrange EQ is often thought of as the most dynamic, because the frequencies that define any particular sound are almost always found in this range. You can create many interesting and useful EQ changes by turning this knob down as well as up.

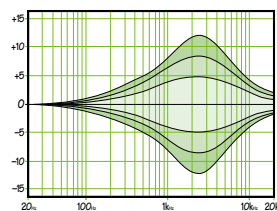

17. Low EQ

The low EQ provides up to 15 dB of boost or cut below 80 Hz. The circuit is flat at the center detent position. This frequency represents the punch in bass drums, bass guitar, fat synth patches, and some really serious male singers who eat raw beef for breakfast.

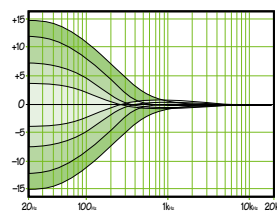

18. Aux Mon

These knobs tap a portion of each channel's signal to set up a nice monitor mix feeding stage monitors, independent of the main mix. Adjust these controls on each channel until the band is happy with the stage monitor mix.

The controls are off when fully turned down, deliver unity gain at the center detent, and can provide up to 15 dB of gain turned fully up.

The pan, mute and channel fader do not affect the monitor output, but the other channel controls will. The aux mon is pre-fader.

The overall output level may be adjusted with the aux master mon controls and monitor 1's EQ tweaked with the graphic EQ if the main mix/mon 1 switch is engaged. Internal FX may also be added to the monitor mix with the internal FX to mon knobs.

19. Aux FX

These knobs tap a portion of each channel's signal to set up a nice FX mix feeding the internal FX processor, and to feed external processors via the FX send.

The controls are off when fully turned down, deliver unity gain at the center detent, and can provide up to 15 dB of gain turned fully up.

The mute, channel fader and other channel controls affect the FX output, but pan does not. The aux FX is post-fader.

The FX signal reaching the internal FX processor and the FX send output jack is the sum (mix) of all the channels whose aux FX control is set to more than minimum.

The overall output level may be adjusted with the aux master FX knob. FX are added to the main mix by increasing the level of the internal FX to main L/R knob. Internal FX may also be added to the monitor mix by increasing the level of the internal FX to mon knobs.

20. Pan / Bal

This control allows you to adjust how much of the channel signal is sent to the left versus the right outputs.

With the knob panned hard left, the signal feeds the main left, sub 1, or sub 3 busses, depending on the setting of the assign switches. With the knob panned hard right, the signal feeds the main right, sub 2, or sub 4 busses, again dependent on the setting of the assign switches.

NOTE Subgroups are on the ProFX16v2, ProFX22v2 and ProFX30v2.

The pan control employs a design called "Constant Loudness." If you have a channel panned hard left (or right) and then pan to the center, the signal is attenuated about 3 dB to maintain the same apparent loudness. Otherwise, it would make the sound appear much louder when panned center.

21. OL LED

This LED indicates the channel's signal level after the gain and EQ controls, but just before the channel's level. So even if the level is turned down, you can see if the channel is being overloaded.

The OL (overload) LED will come on when the channel's input signal is too high. This should be avoided, as distortion will occur. If the OL LED comes on regularly, check that the gain control is set correctly for your input device, and that the channel EQ is not set with too much boost. The OL LED will also illuminate when a channel's mute switch is engaged [ProFX16v2, ProFX22v2 and ProFX30v2].

22. Mute Switch

Mute switches do just what they sound like they do. They turn off the signal by "routing" it into oblivion. Engaging a channel's mute switch (almost) provides the same results as turning the fader all the way down (a pre-aux send is not affected by the channel fader, but it is by the mute switch in the ProFX16v2, ProFX22v2 and ProFX30v2).

Any channel assignments [ProFX16v2, ProFX22v2 and ProFX30v2] to main mix, subgroup 1-2, or subgroup 3-4 will be interrupted and all of the aux sends will be silenced (both pre- and post-fader).

In the ProFX8v2 and ProFX12v2, the aux mon signal is unaffected by the mute switch. The channel insert will continue to provide a signal when a channel is muted. The OL LED will illuminate when a channel's mute switch is engaged [ProFX16v2, ProFX22v2 and ProFX30v2].

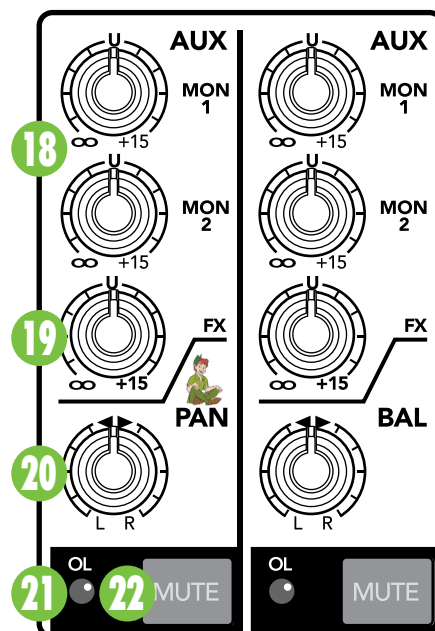

23. Assign Switches [ProFX16v2, ProFX22v2, ProFX30v2]

Alongside each channel fader are three buttons referred to as channel assignment switches. Used in conjunction with the channel's pan knob, they are used to determine the destination of the channel's signal.

With the pan knob at the center detent, the left and right sides receive equal signal levels (main mix L/R, sub 1-2 and sub 3-4). To feed only one side or the other, turn the pan knob accordingly.

If you are doing a mixdown to a 2-track, for example, simply engage the main mix switch on each channel that you want to hear, and they will be sent to the main mix bus. If you want to create a group of certain channels, engage either the 1-2 or 3-4 switches instead of the main mix, and they will be sent to the appropriate subgroup faders. From there, the groups may be sent back to the main mix (using the group assign switches above the group faders), allowing you to use the group faders as a master control for those channels.

If you are creating new tracks or bouncing existing ones, you will also use the 1-2 and 3-4 switches, but not the main mix switch. Here you do not want the groups sent back into the main mix bus, but sent out, via the sub out jacks, to your multitrack inputs.

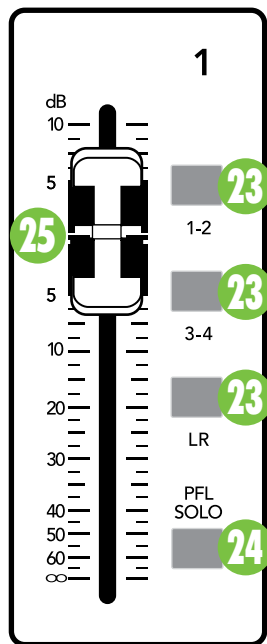

24. PFL Solo Switch [ProFX16v2, ProFX22v2, ProFX30v2]

When a channel's solo switch is engaged, any existing selection is replaced by the solo signal, appearing at the control room outputs, phones and at the left meter. The audible solo levels are then controlled by the CR/phones knob. The solo levels appearing on the meters are not controlled by the CR/phones knob – you would not want that, anyway. What you do want to see is the actual channel level on the meters regardless of how loud the control room and phones output levels might be.

PFL means Pre-Fader Listen (post-EQ). With the PFL Solo switch engaged, solo will not be affected by a channel's mute switch position.

VERY IMPORTANT! Remember, PFL taps the channel signal before the fader. If you have a channel's fader set way below “U” (unity gain), solo will not know that and will send a unity gain signal to the CR outs, phones output and meter display, which may raise some eyebrows.

25. Channel Fader

This is the last control in a channel's signal path, and it adjusts the level of each channel onto the main mix. The “U” mark indicates unity gain, meaning no increase or decrease of signal level. All the way up provides an additional 10 dB, should you need to boost a section of a song. If you find that the overall level is too quiet or too loud with the level near unity, check that the gain control is set correctly.

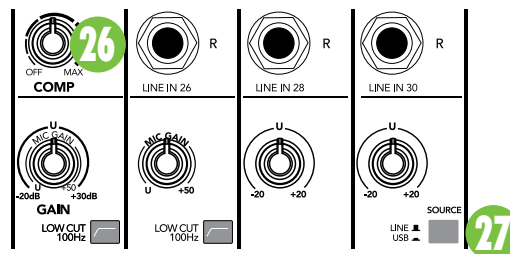

26. Compressor [ProFX16v2, ProFX22v2, ProFX30v2]

Each of the last four mono channels of the ProFXv2 mixer has an in-line compressor circuit with a variable threshold. This is very useful for compression of vocals, and snare drums, for example, so you might consider connecting your vocal and drum mics to these channels, rather than one of the other channels.

When the incoming signal exceeds the threshold level set by this knob, the signal level is automatically compressed. This reduces the dynamic range and reduces the chance of distortion due to overloading the input signals.



Dynamic range is the difference in level between the quietest and loudest parts of a song. A compressor “squeezes” the dynamic range, resulting in an overall steadier, more constant volume level for the signal. It helps sources, such as vocals, “sit” properly in the mix; it is very useful for live sound.

The compression ratio is fixed at around 6:1, with a soft knee response. The threshold can be adjusted clockwise from off (no compression) to 0 dBu (max).

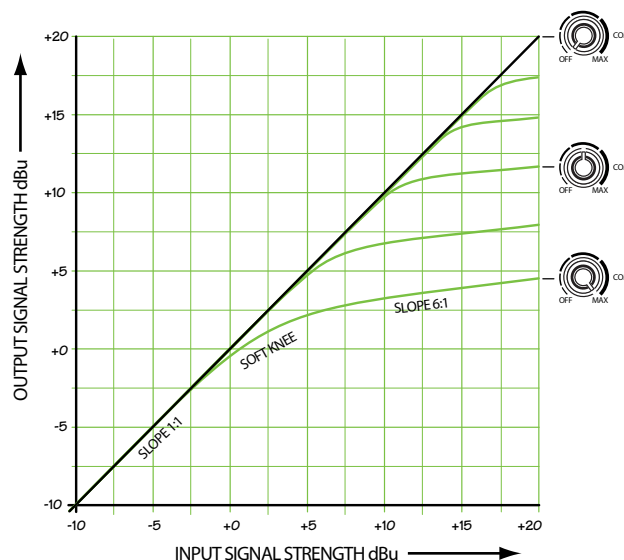

As an example, suppose the threshold is set to maximum. An incoming signal reaches the threshold of 0 dBu. As it increases beyond the threshold, it becomes compressed at a ratio of 6:1. This means that even if the input further increases by 6 dB, the actual output only increases by 1 dB. This compresses the output signal, so

there is more protection to your system from distortion and overload due to poor microphone technique (say it ain't so) and general pops, bangs and heavy metal screaming. The soft knee means that the compression slowly ramps up to 6:1 from the threshold. It does not jump abruptly to 6:1, as this would be hard knee compression, and harder on the ears too.

The graph on the previous page shows the input signal level going into the compressor, versus the output level coming out of it. It is the typical graph to view when compressors are discussed, and is just the kind of thing our engineers like to discuss during the company Christmas party¹.

If the compressor is off, then the input = output. For example an input signal level of +5 dBu results in an output level of +5 dBu. The diagonal line from lower left to upper right represents $x = y$, that is, input = output.

At the maximum compression, the threshold is set at 0 dBu, and the input to output relationship is represented by the lower curve. If the input is -5 dBu (that is, below the threshold), the output is -5 dBu. As the input reaches 0 dBu, the output is a bit less than 0 dBu. If the input is +5 dBu, the output is about +2 dBu. If the input reaches +10 dBu, then the output is +3 dBu. Notice the shapely curve of the soft knee between the diagonal slope of $x = y$ and the compressor slope of 6:1 (the compression ratio).

The other green curves represent in-between positions of the compressor knob, with higher thresholds before compression begins.

Outboard compressors often have controls such as compression ratio, threshold, soft knee/hard knee, attack time, and release time. These last two affect how quickly the compressor kicks in when the input exceeds the threshold, and how quickly it is released after it drops below the threshold. In this compressor, these parameters are specially chosen to give you the best overall performance.

Adjust the threshold carefully, so your dynamic range is still lovely, without distortion or overload during the performance. Run through a few practice screams and high-notes, and adjust the compression as required.

¹ My High School math teacher, Mr. Marvin, thought that graphs might come in handy for me one day. Finally!

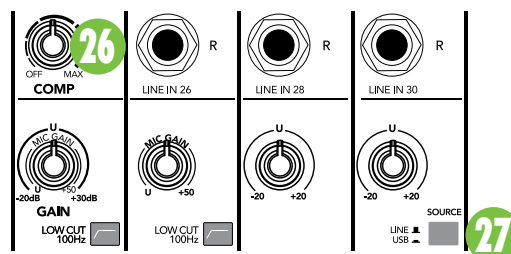

27. USB Switch [ProFX16v2, ProFX22v2, ProFX30v2]

The USB switch on the last stereo channel provides stereo playback of iTunes®, or a DAW via the USB connection. Like any other input, this signal may also be EQ'd, sent to an aux bus, or mixed in with the other signals and assigned to subgroups or main outs. This switch overrides the TRS inputs.

Additional Inputs and Outputs

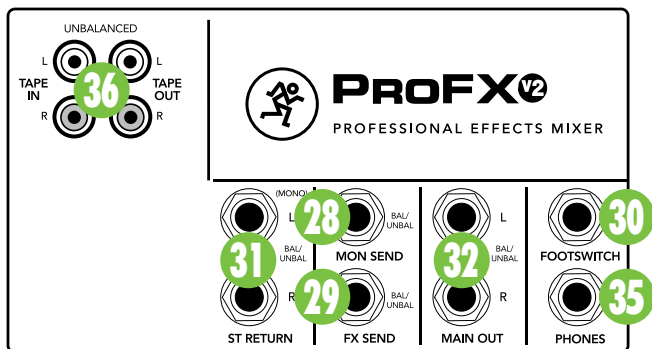

ProFX8v2 • ProFX12v2

28. Mon Send

Stage monitors allow the talented musicians in the band to hear themselves clearly on stage. This can be a good thing! The monitor mix may be carefully adjusted in level using the aux mon controls. These tap a portion of each channel's signal to provide a 1/4" TRS output here to feed external stage monitors. These could either be passive stage monitors powered by an external amplifier, or powered stage monitors with their own built-in amplifier.

The monitor signal is the sum (mix) of all the channels whose aux mon control is set to more than minimum. If they want "more me and less Brian," you may turn up their channel's aux mon control, and turn down Brian's.

The overall output level may be adjusted with the aux master mon knob and mon 1 may have its EQ tweaked with the graphic EQ if the main mix/mon 1 switch is engaged. Alternatively, you could add an external graphic EQ between this output and your powered monitors. This will allow you to adjust the EQ, and minimize the chance of feedback from nearby microphones.

The monitor output is not affected by the main mix fader or the channel faders. This allows you to set up the monitor mix and level just right, and not have it change when a channel fader or the main mix fader is adjusted. This is known as "pre-fader."

NOTE There is one mon send jack on each ProFX8v2 and ProFX12v2, two mon send jacks on each ProFX16v2 and ProFX22v2 and three mon send jacks on each ProFX30v2.

29. FX Send

This 1/4" TRS line-level output may be used to feed an external effects processor (FX), such as a nice sound effect, or delay unit. The output from this jack is an exact copy of what goes into the internal FX processor, being the careful mix of all channels whose aux FX control is turned to more than minimum.

(The processed output of the internal FX does not come out of this output, but is added internally to the main mix or monitor mix.)

The overall output level may be adjusted with the aux master FX knob. (This knob also affects the level going into the internal FX.)

The output is "post-fader," so any changes to the channel faders will also affect the level going to the external processor.

The processed output from the effects processor is usually returned to the aux/stereo returns or a spare channel, and you may carefully mix the original unprocessed channel (dry) and the processed channel (wet). Altering the original channel fader increases both the wet and dry signals and keeps them at the same delicate ratio. For example, the reverb remains at the same level relative to the original.

30. FX Footswitch [ProFX8v2, ProFX12v2, ProFX16v2, ProFX22v2]

This 1/4" TRS connector is where to connect your favorite footswitch. This allows you to easily mute or un-mute the internal effects at will. Any one-button on/off footswitch will work.

If the internal FX have already been muted with the internal FX mute switch, then the footswitch has no effect.

NOTE The ProFX30v2 has an additional mon send jack in place of an FX footswitch jack.

31. Stereo (Aux) Return L/R

The stereo (aux) returns are designed for 1/4" TRS balanced or 1/4" TS unbalanced signals, from -20 dB to +20 dB. They allow the stereo processed output from external effects processors or other devices to be added to the main mix.

Level adjustment of the incoming signals is made with the aux return controls.

You may also use these inputs to add any stereo line-level signals to your main mix, so it could be another line-level source, not just an effects processor.

If you are connecting a mono source, use the left (mono) stereo return input, and the mono signals will appear on both sides of the main mix.

32. Main Out L/R

The 1/4" TRS output connectors provide balanced or unbalanced line-level signals. Connect these to the next device in the signal chain like an external processor (compressor/limiter), or directly to the inputs of the main amplifier. These are the same signal that appears at the XLR main outputs, but 6 dB lower than the XLR outputs. When the meters read "0", these TRS outputs are at 0 dBu.

The male XLR connectors provide a balanced line-level signal that represents the end of the mixer chain, where your fully mixed stereo signal enters the real world. Connect these to the left and right inputs of your main power amplifiers, powered speakers, or serial effects processor (like a graphic equalizer or compressor/limiter). The XLR outputs are 6 dB hotter than the TRS outputs.

NOTE The XLR output jacks on the ProFX8v2 and ProFX12v2 are located on the rear panel.

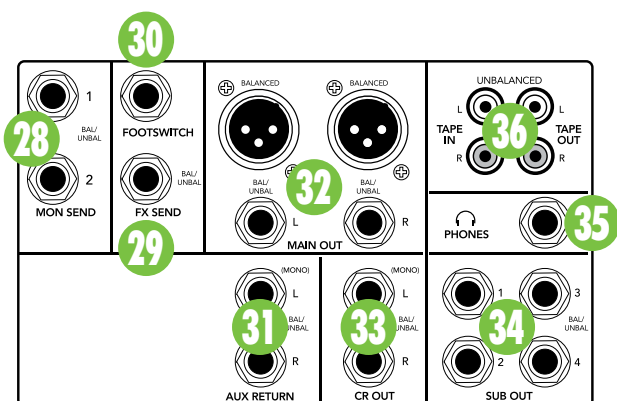

ProFX16v2 • ProFX22v2 • ProFX30v2

33. CR Out L/R [ProFX16v2, ProFX22v2, ProFX30v2]

These 1/4" jacks are usually patched to the inputs of a control room amplifier or a headphone distribution amplifier.

34. Sub Out 1-4 [ProFX16v2, ProFX22v2, ProFX30v2]

These four 1/4" jacks are usually patched to the inputs of a multitrack deck or to secondary amplifiers in a complex installation.

35. Phones

This 1/4" TRS connector supplies the output to stereo headphones. It is the same signal that is routed to the control room outputs.

- The phones volume is controlled with...
- ...the phones knob right above the mon fader [ProFX8v2, ProFX12v2].
 - ...the cr/phones knob right above the main mix fader [ProFX16v2, ProFX22v2, ProFX30v2].

Whenever a solo switch is engaged, you will only hear the soloed channel(s) in the headphones. This gives you the opportunity to audition the channels before they are added to the main mix. (Solo signals reaching the headphones are not affected by the channel level or main level, therefore turn down the phones level first, as soloed channels may be loud.)

- The phones output follows standard conventions:
- Tip = Left channel
 - Ring = Right channel
 - Sleeve = Common ground

VERY IMPORTANT! **WARNING:** The headphone amp is loud and can cause permanent hearing damage. Even intermediate levels may be painfully loud with some headphones. **BE CAREFUL!** Always turn the phones level control all the way down before connecting headphones or pressing a solo switch, or doing anything new that may affect the headphone volume. Then turn it up slowly as you listen carefully.

36. Tape Inputs / Outputs

The stereo unbalanced RCA inputs allow you to play a CD player, MP3 player, or other line-level source. The tape in jacks accept an unbalanced signal using standard hi-fi hookup cables.

The stereo unbalanced RCA outputs allow you to record the main stereo mix onto a hard disk recorder or automatic CD burner, for example. This lets you make a recording for posterity/archive/legal purposes whenever the band gets back together again.

The tape output is the stereo main mix, and it is not affected by the main mix fader. The output could also be used as an extra set of main outputs for feeding another zone.



Stereo Graphic EQ, Main Meters and more!

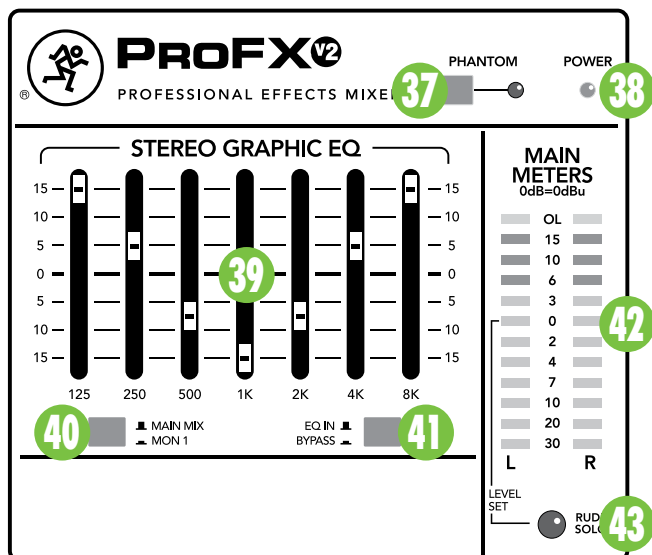

37. 48V Phantom Power Switch

Most modern professional condenser mics require 48V phantom power, which lets the mixer send low-current DC voltage to the mic's electronics through the same wires that carry audio. (Semi-pro condenser mics often have batteries to accomplish the same thing.) "Phantom" owes its name to an ability to be "unseen" by dynamic mics (Shure SM57/SM58, for instance), which don't need external power and aren't affected by it anyway.

Press this switch in if your microphone requires phantom power. (Always check the position of this switch before connecting microphones.) The accompanying LED will illuminate red to indicate that phantom power is active. This is a global switch that affects all mic channels' XLR jacks at once.



Never plug single-ended (unbalanced) microphones, or ribbon mics into the mic input jacks if phantom power is on.

Do not plug instrument outputs into the mic XLR input jacks with phantom power on, unless you know for certain it is safe to do so. Be sure the main mix fader is turned down when connecting microphones to the mic inputs when phantom power is turned on, to prevent pops from getting through to the speakers.

38. Power LED

This LED will illuminate green when the mixer is turned on, as a reminder of how on it really is. If it is not on, then it is off, and the mixer becomes a rather nice weight for keeping your morning newspaper from blowing away in the wind.

If it does not turn on, make sure the power cord is correctly inserted at both ends, the local AC mains supply is active, and the power switch is on.

39. Stereo Graphic EQ

This 7-band graphic equalizer adjusts the main mix output. It affects the line-level outputs, but not the headphones, tape outputs, or the USB output. In the ProFX16v2, ProFX22v2 and ProFX30v2, the control room and phones are post-EQ and post-main fader. In the ProFX8v2 and ProFX12v2, the phones are pre-EQ and pre-main fader.

This EQ may be used for a monitor mix instead of the main mix if the main mix/mon 1 switch is engaged. It may also be quickly bypassed using the EQ in/bypass switch.

Each slider allows you to adjust the level of its frequency band, with up to 15 dB of boost or cut, and no change in level at the center (0 dB) position. The frequency bands are: 125 Hz, 250 Hz, 500 Hz, 1 kHz, 2 kHz, 4 kHz and 8 kHz.

The EQ section comes before the main mix fader and meters. As with the channel EQ, just take it easy. There is a large amount of adjustment, and if you are not careful, you can upset the delicate balance of nature. Although it may not seem cool to actually turn down controls, with EQ it is often the best option. Turn down the offending frequency range rather than boosting the desired range. You may use it to reduce the level of some frequency bands where feedback occurs.

40. Main Mix / Mon 1 Switch

This switch allows you to choose if the stereo graphic EQ is used for the stereo left and right main mix or if it is used for monitors. For example, there may be times when the graphic EQ may be used wisely in the monitor mix to reduce feedback in the monitors from nearby microphones. This only affects the monitor 1 output.

41. EQ In / Bypass Switch

This switch allows you to quickly engage or disengage the stereo graphic EQ. This may be used for quick checks of your EQ settings, or to shorten the signal path if you do not need to use the EQ.

42. Main Meters

These peak meters are made up of two columns of twelve LEDs, with three colors to indicate different ranges of signal level, traffic light style. They range from -30 at the bottom, to 0 in the middle, to +20 (OL) at the top.

When a channel is soloed [ProFX16v2, ProFX22v2, ProFX30v2], the right meter shows no reading, and the left meter shows the level of that channel's signal level, pre-fader.

The left meter's 0 dB LED is labeled "level set" to show where the level should be when adjusting a channel's gain in the solo mode.

When 0 dBu (0.775 V) is at the main left and right TRS outputs, it shows as 0 dB on the meters.

You can get a good mix with peaks flashing anywhere between -20 and +10 dB on the meters. Most amplifiers clip at about +10 dBu, and some recorders aren't so forgiving either. For best real-world results, try to keep your peaks between "0" and "+6." Remember, audio meters are just tools to help assure you that your levels are "in the ballpark." You don't have to stare at them (unless you want to).

43. Rude Solo LED [ProFX16v2, ProFX22v2, ProFX30v2]

This large LED flashes red when one or more solo switches are engaged. This acts as a reminder that what you hear in the control room and headphones is the soloed channel(s). If you forget that you are in solo mode, you can easily be tricked into thinking that something is wrong with your mixer. Hence, the rude solo light. Please forgive its rudeness, it is only trying to help, and wants to be your friend.

Aux Masters, Aux Returns and Internal FX

44. Aux Masters

These provide overall control over the aux mon and aux FX levels just before they are delivered to the aux mon and aux FX outputs, as well as internal FX in the case of the FX master.

Auxiliary is usually the control you turn up when the lead singer glares at you, points at his stage monitor, and sticks his thumb up in the air. (It would follow that if the singer stuck his thumb down, you'd turn the knob down, but that never happens.)

NOTE The aux master mon 1 knob on the ProFX16v2, ProFX22v2 and ProFX30v2 is the mon fader on the ProFX8v2 and ProFX12v2.

45. Stereo (Aux) Returns

These controls set the overall level of line signals received from the stereo (aux) return L/R jacks. Signals passing through these controls go directly to the main mix and monitor mix where they are combined with signals from the channels.

46. Internal FX

These knobs route the effects output to the mon and mains independently. Use the mon controls to provide effects to monitors. Slowly add effects to the monitors by turning the mon knobs clockwise. Use the aux master to monitor the amount sent. The FX output to the mains will be heard directly from the PA.

47. Preset Selector

Rotate this endless control to select one of the 16 preset effects. When the rotation stops, that preset will be loaded and become operational. The current preset number is shown in the display. The different presets are shown in the table below and on the mixer's silkscreen near the stereo graphic EQ. Further details of each preset are explained in Appendix C on page 38. Only one preset may be selected at a time.

1	Bright Room	9	Chorus
2	Warm Lounge	10	Chorus + Reverb
3	Small Stage	11	Doubler
4	Warm Theater	12	Echo
5	Warm Hall	13	Delay 1 (Fast)
6	Concert Hall	14	Delay 2 (Medium)
7	Plate Reverb	15	Delay 3 (Slow)
8	Cathedral	16	Pan Delay

48. Preset Display

This display shows the number of the currently selected effects preset, as shown in the list of presets above. Rotate the preset selector knob right or left to change a preset.

A new preset will be loaded approximately 1/4 of a second after you stop turning the knob, and it will be stored into the FX memory after about one second. When the mixer is turned on, the FX section will load up the last-used preset.

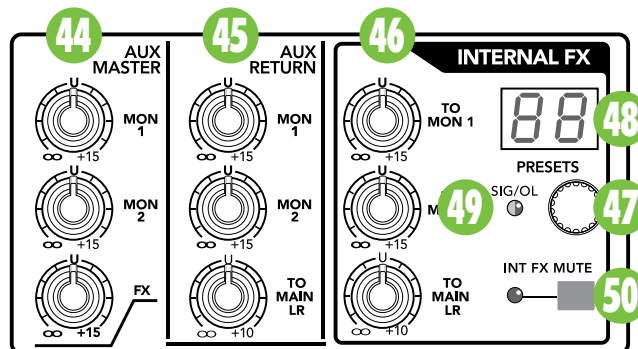

ProFX16v2 • ProFX22v2 • ProFX30v2

49. SIG / OL LED

This bi-colored LED illuminates green when the signal level going into the effects processor is within a good operating range (sig). It illuminates red if the effects processor is overloaded with too strong of a signal (ol). Turn down the FX send master level and check the channel sends if these light red regularly.

The signals going into the processor are affected by the channel gain, EQ, and channel faders, as well as the channel FX sends and the FX send master.

NOTE This LED only illuminates green (sig) on the ProFX16v2, ProFX22v2 and ProFX30v2.

50. Int FX Mute Switch and LED

When engaged, the internal effects processor is muted, and its output will not appear on the main mix or monitor mix. The adjacent mute LED will illuminate as a reminder that the effects are muted. When power is first applied, this LED will illuminate and the FX will be muted for about 10 seconds while the little FX gerbils inside settle down.

If this switch is not engaged, then the internal effects are set free and may be added as required to the main mix and/or monitor mix.

If this switch is not engaged, then the internal effects may be muted or un-muted with a footswitch [ProFX8v2, ProFX12v2, ProFX16v2 and ProFX22v2].

51. Mute and OL LED (for stereo returns) [ProFX8v2 and ProFX12v2]

Press this switch in to mute the signals coming into the stereo return inputs.

The adjacent LED will light if the signal coming into the stereo return inputs is too high, and this may cause distortion due to overloading.

The OL LED comes before the stereo return fader, so the fader has no effect in your efforts to turn off the OL LED.

Check external processors and other devices, and turn down their levels until the OL LED does not come on.

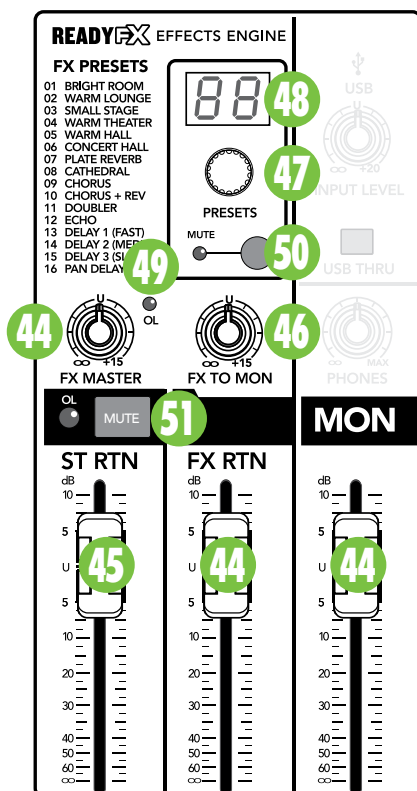

ProFX8v2 • ProFX12v2

Main & Subs Mix, USB Out, 2-Track Return, and more!

52. USB Input Level [ProFX8v2, ProFX12v2]

This control adjusts the signal level of the two channels coming in from the computer, via the USB port, relative to the mix of the other channels. Adjust it carefully to achieve the desired mix with the other channels.

The USB input from audio software could be individual instrument tracks, a mix of tracks, or processed tracks.

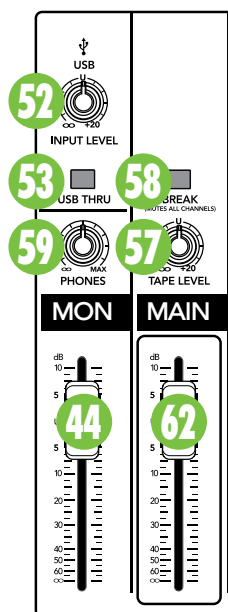

ProFX8v2 • ProFX12v2

53. USB Thru [ProFX8v2, ProFX12v2]

In addition to a mix of the other channels, the USB output to the computer may contain any input from the computer if this switch is down. (This switch only affects the output to the computer, not the headphones or main mix.)

- If disengaged (out), the USB output to the computer will just be the main mix. This is a good position for overdubbing, as any playback from the computer may be played through the main speakers and headphones, while playing along with a guitar and recording only the guitar via USB. This is also good for live recording as a safeguard against feedback. Here, the USB level knob should also be down.
- If pressed in, the USB output to the computer will be the main mix, including any audio coming in from the computer. This is a good position to record live performances where playback of audio from the computer is also part of the performance.

54. USB Out Switch [ProFX16v2, ProFX22v2, ProFX30v2]

This switch allows flexibility on the recordable signals. The default switch configuration (disengaged) allows the main L/R mix to be recorded for convenient stereo mixes of the show. Engaging the switch routes subgroups 1-2 over the USB connection to your favorite DAW software for an alternate 2-track recording.

55. 2-Track Return Tape / USB Switch [ProFX16v2, ProFX22v2, ProFX30v2]

This determines if the 2-track return gets its signal from the RCA “tape” inputs (switch disengaged) or USB (switch engaged).

56. 2-Track Return Level [ProFX16v2, ProFX22v2, ProFX30v2]

This knob controls the overall level to the mains of the tape (RCA) or USB, depending on the position of the 2-track return tape/USB switch. This knob's level ranges from off, through unity (center detent position), on up to 15 dB of extra gain (fully clockwise).

57. Tape Level [ProFX8v2, ProFX12v2]

This knob controls the input level of signals entering the tape inputs. It is conveniently located close to the break switch so all channels may be quickly muted while bringing up the background music while the band is taking a break.

58. Break Switch and LED

This important “take-a-break” switch quickly mutes all the microphones and line-level inputs to the main outs, or outs and phones when the band is between sets. This will prevent protestors or rogue karaoke singers from storming the stage at the interval.

The monitor send and FX send are not affected. If there is no sound coming out of the system, be sure to check this switch first.

It is possible to play the stereo RCA tape inputs in the main stereo mix or play audio coming in from the computer via the USB inputs. For example, a soothing CD may be played while the band is off stage.

NOTE The adjacent break LED [ProFX16v2, ProFX22v2 and ProFX30v2] will illuminate as a reminder that the channels are muted.

59. CR / Phones

As one might expect, this knob controls the levels of both the stereo control room and the headphones. Make sure that this knob is fully off [counter-clockwise] before selecting or adding a new source.

Whatever the selection, the control room outputs may also be used for other applications. The sound quality is just as impeccable as the main outputs. It may be used as an additional main mix output and this one will have its own level control. However, be aware that if a solo switch is engaged, the mix will be interrupted:

When a channel's solo switch is engaged, any existing selection is replaced by the solo signal, appearing at the control room outputs, phones and at the left meter. The audible solo levels are then controlled by the control room knob. The solo levels appearing on the meters are not controlled by the control room knob – you would not want that, anyway. What you do want to see is the actual channel level on the meters regardless of how loud the control room and phones output levels might be.



Control room is available on the ProFX16v2, ProFX22v2 and ProFX30v2.



Solo signals reaching the headphones and monitor outputs are not affected by the channel level or main level; therefore, turn down the phones level and monitor level first, as soloed channels may be loud.

60. Subs Assign Switches [ProFX16v2, ProFX22v2, ProFX30v2]

One popular use of the subs is to use them as master faders for a group of channels on their way to the main mix fader. Let us say you have a drum kit hogging up seven channels and you are going to want to control their group volume more conveniently. You do not want to try that with seven hands or seven fingers, so just unassign these channels from the main mix and reassign them to subs 1-2, engage the assign to main mix left on sub 1 and assign to main mix right on sub 2. Now you may ride the entire drum mix with two faders – subs 1 and 2.

If you engage just one assign to main mix button per group (left or right), the signal sent to the main mix fader will be the same level as the sub outs. If you want the subgroup to appear in the center of the main mix, engage both the assign to main mix left and right buttons. The signal will be sent to both sides, and reduced in level by 3 dB like a pan pot, so the overall level is the same, whether the group is assigned to main left, main right, or both.

61. Sub 1-4 Faders [ProFX16v2, ProFX22v2, ProFX30v2]

As you might expect, these faders control the levels of the signals sent to the sub out jacks. All channels that are assigned to subs, not muted, and not turned fully down will appear at the sub outs.

The sub signal is off when its fader is fully down, the “U” marking is unity gain, and fully up provides 10 dB additional gain. Remember that if you are treating two subs as a stereo pair, sub 1 and 2 for example, make sure that both sub faders “ride” together to maintain the left/right balance.

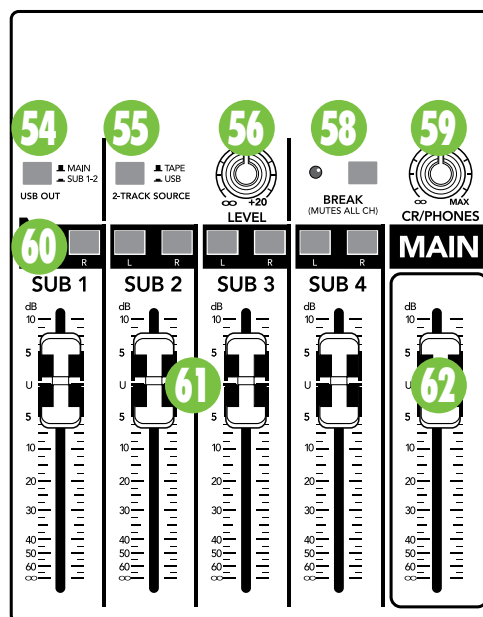

ProFX16v2 • ProFX22v2 • ProFX30v2

62. Main Mix

This stereo fader allows you to adjust the levels of the main mix signals sent to the XLR and 1/4" main line-level outputs and the tape outputs.

This gives you the ultimate feeling of power and control over the sound levels sent to your audience. Adjust this control carefully, with your good eye on the meters to check against overloading, and your good ear to the levels to make sure your audience (if any) is happy.

The main mix signals are off with the fader fully down, the “U” marking is unity gain, and fully up provides 10 dB of additional gain. This additional gain will typically never be needed, but once again, it’s nice to know that it’s there. The fader is stereo, as it affects both the left and right of the main mix equally. This is the ideal control to slowly bring down at the end of a song (or quickly in the middle of a song if the need ever arises).

This control does not affect the mon send or FX send outputs.

Appendix A: Service Information

If you think your mixer has a problem, please check out the following troubleshooting tips and do your best to confirm the problem. Visit the Support section of our website (www.720trees.com) where you will find lots of useful information such as FAQs, documentation and any updated PC drivers etc. You may find the answer to the problem without having to send your mixer away.

Troubleshooting

Bad Channel

- Is the channel EQ set up nicely?
- Is the channel gain set correctly?
- Is the channel level up enough?
- Is the channel OL led on?
- Is the channel pan set in the middle?
- Try the same source signal in another channel, set up exactly like the suspect channel.
- Is phantom power required for your microphone?

Bad Output

- Is the main level turned up?
- Are the EQs set to reasonable levels?
- Are any aux returns maxed out?
- Unplug anything from the other line-level outputs, such as monitor out, just in case one of the external pieces has a problem.
- Make sure that you are not overdriving the amplifiers. Check the loudspeaker average load impedance is not less than the minimum the amplifier can handle. Check the speaker wiring.

Noise

- Turn the channel gains down, one by one. If the sound disappears, it's either that channel or whatever is plugged into it, so unplug whatever that is. If the noise disappears, it's from your whatever.

Power

- The power LED should come on if the mixer is connected to a suitable live AC mains outlet, and the power switch is on. Check to make sure that the power cord is securely plugged in.

Repair

For warranty service, refer to the warranty information on page 39.

Non-warranty service is available at a factory-authorized service center. To locate your nearest service center, visit www.720trees.com, click "Support" and select "Locate a Service Center." Service for ProFXv2 Series mixers living outside the United States can be obtained through local dealers or distributors.

If you do not have access to our website, you can call our Tech Support department at 1-800-898-3211, Monday-Friday during normal business hours, Pacific Time, to explain the problem. Tech Support will tell you where the nearest factory-authorized service center is located in your area.

Appendix B: Technical Information

Specifications

Noise Characteristics

Equivalent Input Noise (EIN) (150 Ω Source Impedance, 20 Hz to 20 kHz)	
Mic in to Insert Send out, max gain	-125 dBu ¹ -128 dBu ²
Residual Output Noise	
All outputs, master levels off, all channel levels off	-95 dBu
All outputs, master levels unity, one channel level unity	-80 dBu ¹ -85 dBu ²

Frequency Response

Mic input to any output (gain at unity, +0 dB / -1 dB)	
	20 Hz to 30 kHz ¹ 20 Hz to 40 kHz ²

Distortion (THD+N)

(22 Hz to 80 kHz bandwidth)	
Mic in to Main Out (+4 dBu output)	<0.03% ¹ <0.01% ²

Attenuation and Crosstalk

Adjacent Inputs @ 1 kHz	-90 dBu
Inputs to Outputs @ 1 kHz	-80 dBu
Fader Off @ 1 kHz	-75 dBu
Mute Switch / Break Switch Mute @ 1 kHz	-90 dBu ¹ -100 dBu ²

Common Mode Rejection Ratio (CMRR)

Mic in to Main out, max gain, 1 kHz	70 dB
-------------------------------------	-------

Maximum Levels

All inputs	+22 dBu
Main Out XLR	+28 dBu
All other outputs	+22 dBu

Impedances

Mic in	3.8 kΩ ¹ 3.3 kΩ ²
Channel Insert Return	10 kΩ
All other inputs	≥20 kΩ
Tape out	1 kΩ
Phones out	25 Ω
All other outputs	120 Ω Unbalanced, 240 Ω Balanced

Equalization

ProFX8v2 • ProFX12v2

Low	±15 dB @ 80 Hz
Mid	±15 dB @ 2.5 kHz
High	±15 dB @ 12 kHz
Low Cut Filter	18 dB/octave @ 100 Hz

ProFX16v2 • ProFX22v2 • ProFX30v2

Mono Channels	
Low	±15 dB @ 80 Hz
Mid	±15 dB 100 Hz – 8 kHz
High	±15 dB @ 12 kHz
Low Cut Filter	18 dB/octave @ 100 Hz
Stereo Channels	
Low	±15 dB @ 80 Hz
Mid	±15 dB @ 2.5 kHz
High	±15 dB @ 12 kHz

Maximum Voltage Gain (EQ Flat)

Mic Input Channel to	
Insert Output	50 dB
Tape Output	60 dB
USB Output	50 dB ¹ 60 dB ²
1/4" Main Output	70 dB
XLR Main Output	76 dB
Monitor Send	76 dB ¹ 81 dB ²
FX Send	90 dB
Mono Line Input Channel to	
Insert Output	30 dB
Tape Output	40 dB
USB Output	30 dB ¹ 40 dB ²
XLR Main Output	56 dB
Monitor Send	56 dB ¹ 61 dB ²
FX Send	70 dB
Stereo Line Input Channel to	
Tape Output	30 dB
USB Output	30 dB
XLR Main Output	46 dB
Monitor Send	46 dB ¹ 51 dB ²
FX Send	60 dB ¹ 55 dB ²
Tape Input to	
XLR Main Output	36 dB
USB Input to	
XLR Main Output	36 dB
Stereo Return to	
Mon Output	30 dB ²
XLR Main Output	26 dB

¹ ProFX8v2, ProFX12v2.

² ProFX16v2, ProFX22v2, ProFX30v2.

Specifications continued...

Digital Effects

I/O	Mono Input, Stereo Output
Number of Presets	16

Meters

Main L/R Mix	
Two columns of 12 segments each:	
OL (+20 dBu), +15, +10, +6, +3, 0 (0 dBu), -2, -4, -7, -10, -20, -30	

Graphic EQ

Frequency Centers	125, 250, 500, 1k, 2k, 4k, 8k
Gain	±15 dB
Assignable to Main or Monitor, bypassable	

USB

Format	USB 1.1
I/O	Stereo Input, Stereo Output
A/D/A	16 bit, 44.1 kHz / 48 kHz

Phantom Power

48 VDC to all Mic channels simultaneously

AC Power Requirements

Power Consumption	20 watts (ProFX8v2) 30 watts (ProFX12v2) 40 watts (ProFX16v2) 45 watts (ProFX22v2) 50 watts (ProFX30v2)
Universal AC Power Supply Power Connector	100 – 240 VAC, 50 – 60 Hz 3 Pin IEC

Physical Dimensions and Weight

ProFX8v2

Height	3.6 in / 91 mm
Width	11.4 in / 290 mm
Depth	14.1 in / 358 mm
Weight	7.1 lb / 3.2 kg

ProFX12v2

Height	3.6 in / 91 mm
Width	14.6 in / 370 mm
Depth	14.1 in / 358 mm
Weight	9.0 lb / 4.1 kg

ProFX16v2

Height	3.8 in / 97 mm
Width	18.7 in / 475 mm
Depth	16.0 in / 407 mm
Weight	13.0 lb / 5.9 kg

ProFX22v2

Height	3.8 in / 97 mm
Width	25.1 in / 639 mm
Depth	16.0 in / 407 mm
Weight	18.0 lb / 8.2 kg

ProFX30v2

Height	3.8 in / 97 mm
Width	33.6 in / 853 mm
Depth	16.6 in / 422 mm
Weight	25.0 lb / 11.4 kg

Options

ProFX8v2

Bag	P/N 0020636
Cover	P/N 0020638

ProFX12v2

Bag	P/N 0020637
Cover	P/N 0020639
Rack Ear Kit	P/N 2045757-00

ProFX16v2

Bag	P/N 2036809-10
Cover	P/N 2036809-12
Rack Ear Kit	P/N 2036168-00

ProFX22v2

Bag	P/N 2036809-11
Cover	P/N 2036809-13

ProFX30v2

Cover	P/N 2036809-30
-------	----------------

LOUD Technologies Inc. is always striving to improve our products by incorporating new and improved materials, components, and manufacturing methods. Therefore, we reserve the right to change these specifications at any time without notice.

The "Running Man" is a registered trademark of LOUD Technologies Inc. All other brand names mentioned are trademarks or registered trademarks of their respective holders, and are hereby acknowledged.

Please check our website for any updates to this manual: www.720trees.com.

©2015 LOUD Technologies Inc. All Rights Reserved.

ProFX8v2 and ProFX12v2 Dimensions

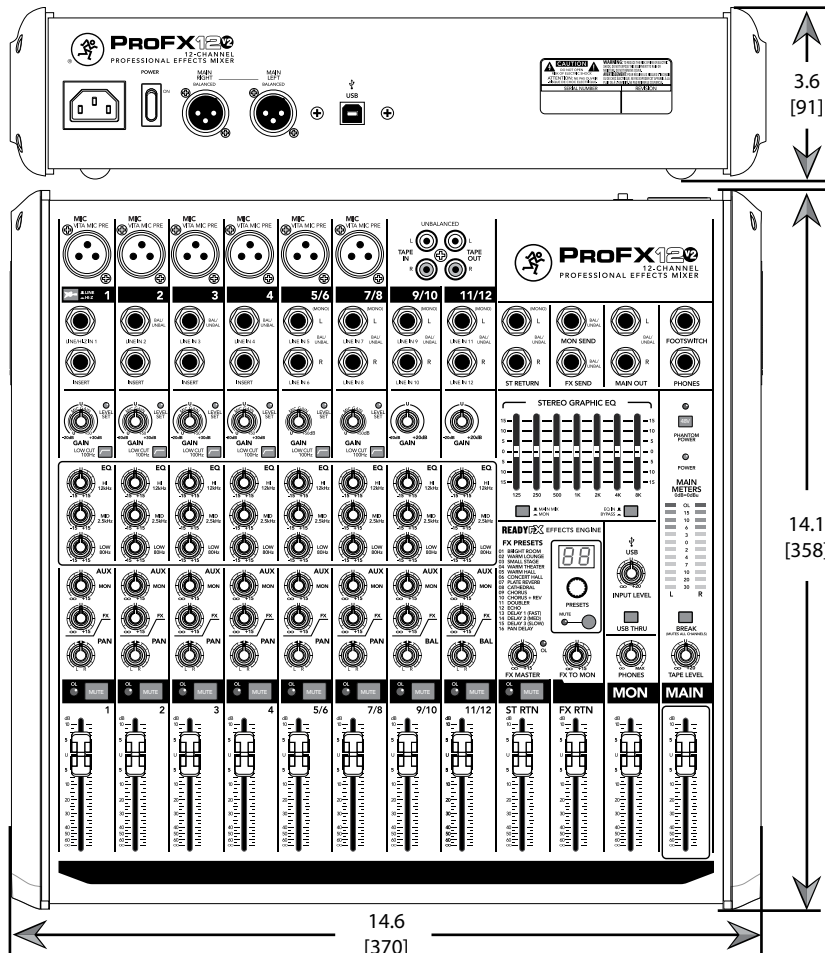
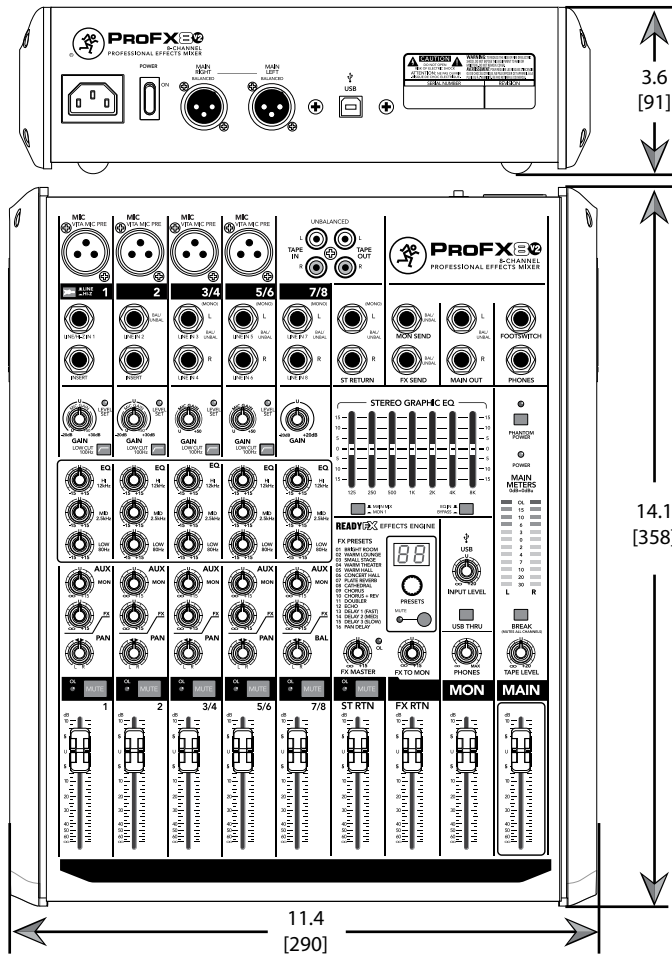

ProFX16v2 Dimensions

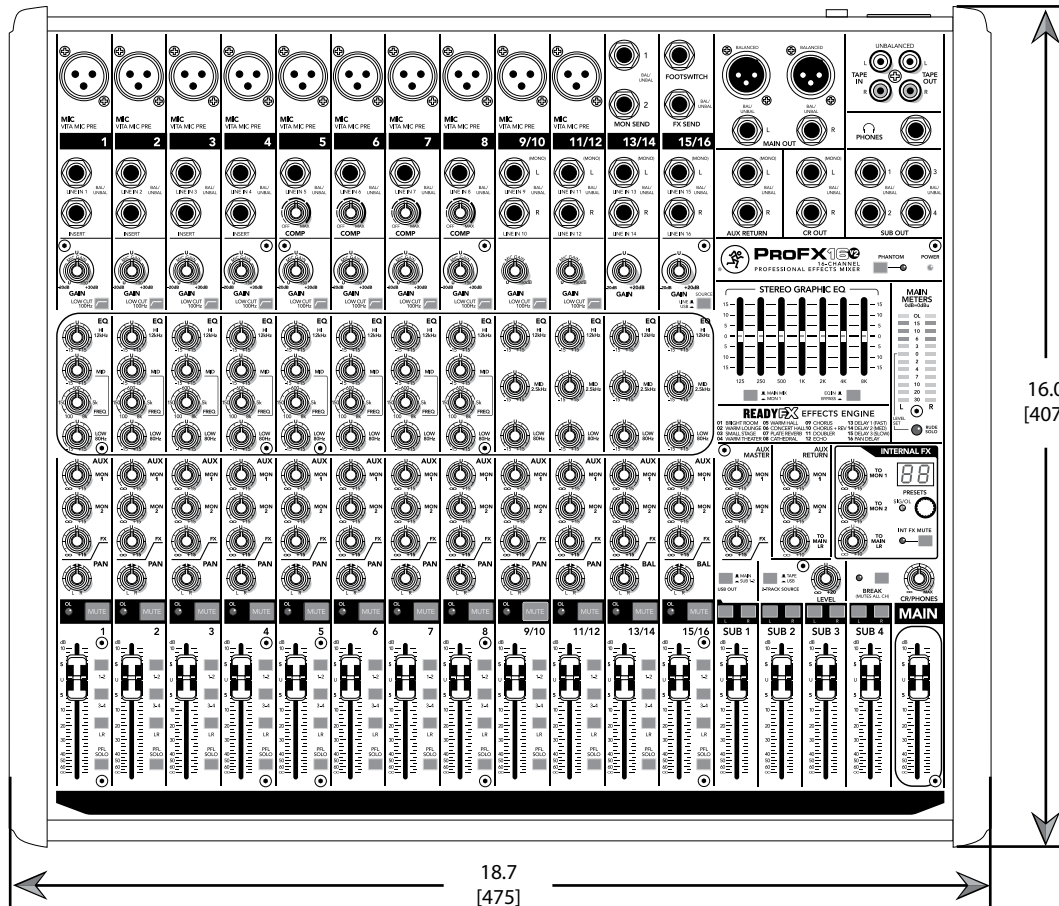
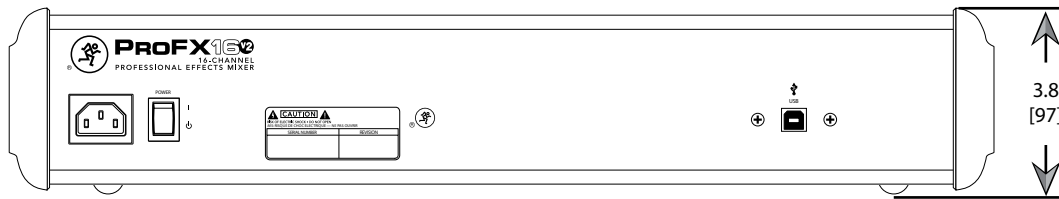

ProFX22v2 Dimensions

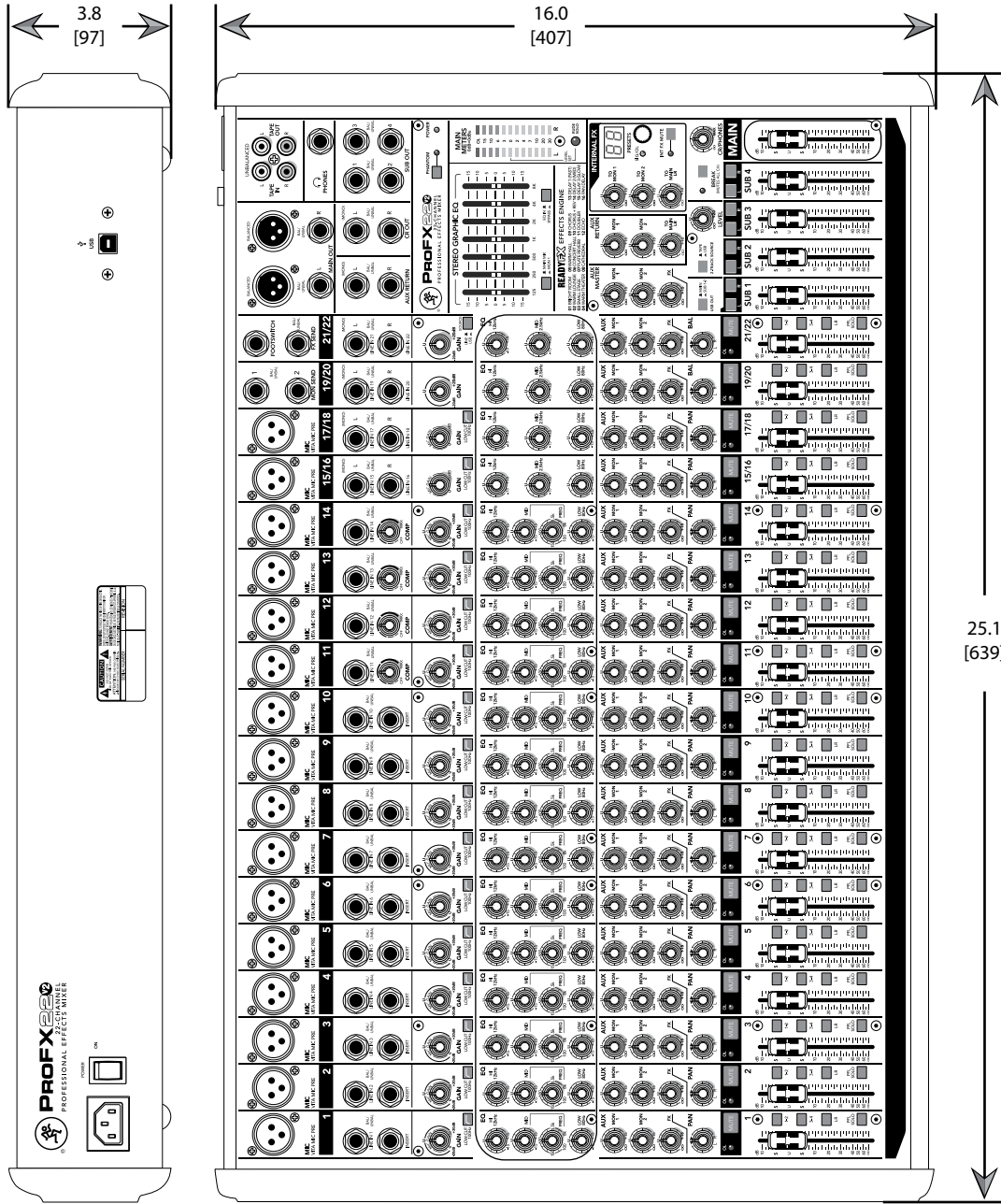

ProFX8v2 and ProFX12v2 Block Diagram

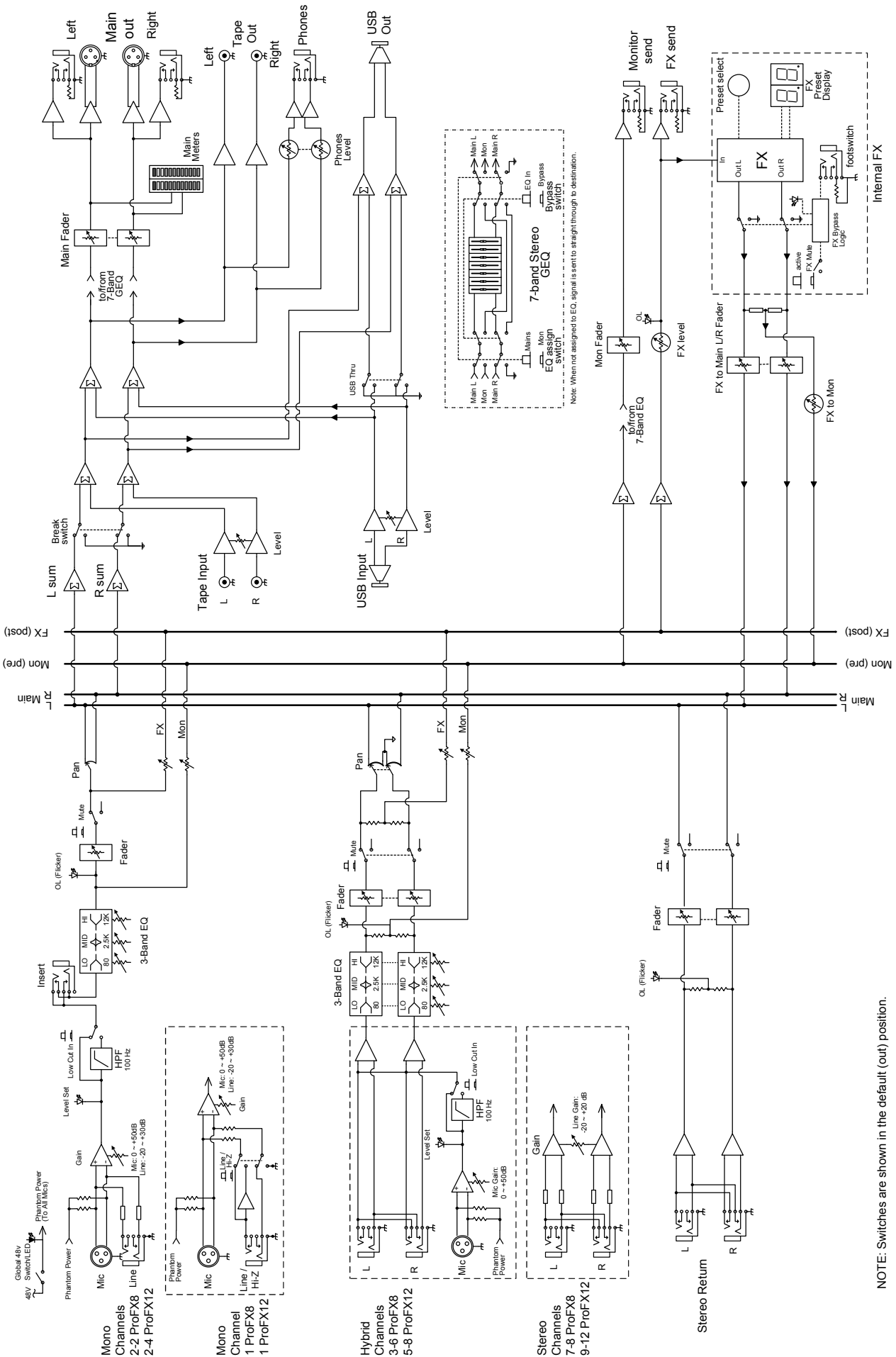

NOTE: Switches are shown in the default (out) position.

ProFX30v2 Block Diagram

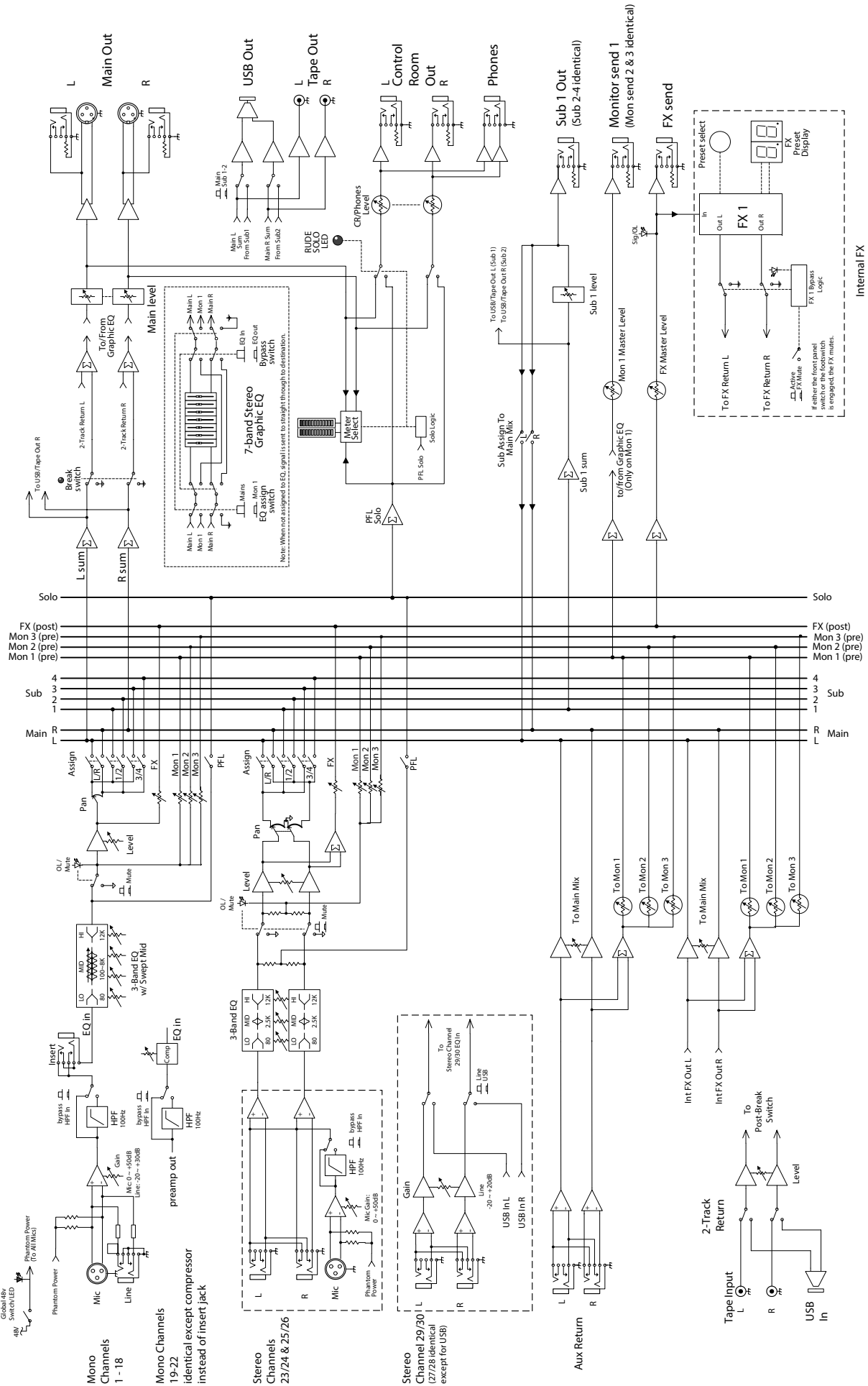

Track Sheet – Mono Channels

MIC VITA MIC PRE	MIC VITA MIC PRE	MIC VITA MIC PRE	MIC VITA MIC PRE	MIC VITA MIC PRE	MIC VITA MIC PRE	MIC VITA MIC PRE	MIC VITA MIC PRE
LINE IN BAL/ UNBAL	LINE IN BAL/ UNBAL	LINE IN BAL/ UNBAL	LINE IN BAL/ UNBAL	LINE IN BAL/ UNBAL	LINE IN BAL/ UNBAL	LINE IN BAL/ UNBAL	LINE IN BAL/ UNBAL
INSERT	INSERT	INSERT	INSERT	INSERT	INSERT	INSERT	INSERT
GAIN LOW CUT 100Hz	GAIN LOW CUT 100Hz	GAIN LOW CUT 100Hz	GAIN LOW CUT 100Hz	GAIN LOW CUT 100Hz	GAIN LOW CUT 100Hz	GAIN LOW CUT 100Hz	GAIN LOW CUT 100Hz
EQ HI 12kHz	EQ HI 12kHz	EQ HI 12kHz	EQ HI 12kHz	EQ HI 12kHz	EQ HI 12kHz	EQ HI 12kHz	EQ HI 12kHz
MID	MID	MID	MID	MID	MID	MID	MID
LOW 80Hz	LOW 80Hz	LOW 80Hz	LOW 80Hz	LOW 80Hz	LOW 80Hz	LOW 80Hz	LOW 80Hz
AUX MON 1	AUX MON 1	AUX MON 1	AUX MON 1	AUX MON 1	AUX MON 1	AUX MON 1	AUX MON 1
MON 2	MON 2	MON 2	MON 2	MON 2	MON 2	MON 2	MON 2
MON 3	MON 3	MON 3	MON 3	MON 3	MON 3	MON 3	MON 3
FX	FX	FX	FX	FX	FX	FX	FX
PAN	PAN	PAN	PAN	PAN	PAN	PAN	PAN
MUTE	MUTE	MUTE	MUTE	MUTE	MUTE	MUTE	MUTE
dB 1-2	dB 1-2	dB 1-2	dB 1-2	dB 1-2	dB 1-2	dB 1-2	dB 1-2
3-4	3-4	3-4	3-4	3-4	3-4	3-4	3-4
LR	LR	LR	LR	LR	LR	LR	LR
PFL SOLO	PFL SOLO	PFL SOLO	PFL SOLO	PFL SOLO	PFL SOLO	PFL SOLO	PFL SOLO

Track Sheet – Comp & Stereo Channels

 MIC VITA MIC PRE		 MIC VITA MIC PRE		 MIC VITA MIC PRE		 MIC VITA MIC PRE		 MIC VITA MIC PRE		 MIC VITA MIC PRE	
 LINE IN BAL/UNBAL		 LINE IN BAL/UNBAL		 LINE IN BAL/UNBAL		 LINE IN BAL/UNBAL		 LINE IN BAL/UNBAL		 LINE IN BAL/UNBAL	
 OFF MAX COMP		 OFF MAX COMP		 OFF MAX COMP		 OFF MAX COMP		 OFF MAX COMP		 OFF MAX COMP	
 U +50 -20dB GAIN LOW CUT 100Hz		 U +50 -20dB GAIN LOW CUT 100Hz		 U +50 -20dB GAIN LOW CUT 100Hz		 U +50 -20dB GAIN LOW CUT 100Hz		 U +50 GAIN LOW CUT 100Hz		 U +50 GAIN LOW CUT 100Hz	
 HI 12kHz -15 +15 EQ		 HI 12kHz -15 +15 EQ		 HI 12kHz -15 +15 EQ		 HI 12kHz -15 +15 EQ		 HI 12kHz -15 +15 EQ		 HI 12kHz -15 +15 EQ	
 MID 600-1.5k -15 +15 EQ		 MID 600-1.5k -15 +15 EQ		 MID 600-1.5k -15 +15 EQ		 MID 600-1.5k -15 +15 EQ		 MID 2.5kHz -15 +15 EQ		 MID 2.5kHz -15 +15 EQ	
 LOW 80Hz -15 +15 EQ		 LOW 80Hz -15 +15 EQ		 LOW 80Hz -15 +15 EQ		 LOW 80Hz -15 +15 EQ		 LOW 80Hz -15 +15 EQ		 LOW 80Hz -15 +15 EQ	
 MON 1 ∞ +15 AUX		 MON 2 ∞ +15 AUX		 MON 3 ∞ +15 AUX		 MON 1 ∞ +15 AUX		 MON 2 ∞ +15 AUX		 MON 3 ∞ +15 AUX	
 FX ∞ +15 AUX		 FX ∞ +15 AUX		 FX ∞ +15 AUX		 FX ∞ +15 AUX		 FX ∞ +15 AUX		 FX ∞ +15 AUX	
 L R PAN		 L R PAN		 L R PAN		 L R PAN		 L R PAN		 L R PAN	
 MUTE		 MUTE		 MUTE		 MUTE		 MUTE		 MUTE	
 dB 10 5 0 U 5 10 20 30 40 50 60 ∞ 1-2 3-4 LR PFL SOLO		 dB 10 5 0 U 5 10 20 30 40 50 60 ∞ 1-2 3-4 LR PFL SOLO		 dB 10 5 0 U 5 10 20 30 40 50 60 ∞ 1-2 3-4 LR PFL SOLO		 dB 10 5 0 U 5 10 20 30 40 50 60 ∞ 1-2 3-4 LR PFL SOLO		 dB 10 5 0 U 5 10 20 30 40 50 60 ∞ 1-2 3-4 LR PFL SOLO		 dB 10 5 0 U 5 10 20 30 40 50 60 ∞ 1-2 3-4 LR PFL SOLO	

PROFX 30-CHANNEL PROFESSIONAL EFFECTS MIXER

STEREO GRAPHIC EQ

15 10 5 0 5 10 15 | 15 10 5 0 5 10 15

125 250 500 1k 2k 4k 8k

MAIN MIX MON 1 EQ IN BYPASS

READYFX EFFECTS ENGINE

01 BRIGHT ROOM 05 WARM HALL 09 CHORUS 13 DELAY 1 (FAST)
 02 WARM LOUNGE 06 CONCERT HALL 10 CHORUS + REV 14 DELAY 2 (MED)
 03 SMALL STAGE 07 PLATE REVERB 11 DOUBLER 15 DELAY 3 (SLOW)
 04 WARM THEATER 08 CATHEDRAL 12 ECHO 16 PAN DELAY

INTERNAL FX

PRESETS SKI/OL INT FX MUTE

MAIN METERS
 0dB=0dBu
 OL 15 10 6 3 0 2 4 7 10 20 30
 L R

SUB 1 SUB 2 SUB 3 SUB 4 MAIN

dB 10 5 U 5 10 20 30 40 50 60 ∞

Appendix C: Table of Effects Presets

No.	Title	Description	Example of its use
01	Bright Room	This room has a bright tone with lots of scattered reflections to simulate harder, more reflective surfaces.	Useful on vocals that require a brighter reverb to cut through the mix, or for giving acoustic instruments a livelier vibe.
02	Warm Lounge	This preset features a medium sized room sound, with just enough enhancement of the lower mids to produce a warm tone.	Useful for vocals on songs that require a larger, more "wet" sound, or for giving dimension to bright horns without adding harshness.
03	Small Stage	This preset simulates the sound of a small concert stage, with a medium reverb time and reverberant space.	Useful for vocals or guitars in fast paced, high-energy songs that call for a "live" sounding reverberation.
04	Warm Theater	This reverb has a warm bodied tone and medium long reverb time to simulate the live acoustics of a theater space.	Perfect for vocals, drums, acoustic and electric guitars, keyboards and more.
05	Warm Hall	This reverb simulates the sound of a spacious, yet cozy, heavily draped and carpeted concert hall with an especially warm tone.	Perfect for adding natural concert hall ambience to close-mic'ed orchestral instruments.
06	Concert Hall	This hall reverb is characterized by its large, spacious sound, long pre-delay, and vibrant tone.	Adds life to acoustic instruments and vocals from solos to full-on symphonies and choirs.
07	Plate Reverb	This preset emulates vintage mechanical reverberation that was generated with a metal plate. Its sound is characterized by lots of early reflections and no pre-delay.	Perfect for thickening percussive instruments, such as a snare drum, or tight vocal arrangements.
08	Cathedral	This reverb emulates the extremely long tails, dense diffusion and long pre-delays and reflections that would be found in a very large, stone walled house of worship.	Gives amazing depth to choirs, wind instruments, organs and soft acoustic guitars.
09	Chorus	This preset provides a soft, ethereal sweeping effect that is useful for thickening and for making a particular sound pop out of the mix.	Perfect for enhancement of electric and acoustic guitar and bass, or to add a dramatic effect to vocals, particularly group harmonies and choirs.
10	Chorus + Reverb	This preset perfectly combines the chorus effect above with a large, roomy reverb.	This effect thickens the sound with chorus while adding warmth and spaciousness thanks to the smooth reverb.
11	Doubler	This effect simulates the sound of a vocal or instrument being recorded twice (double-tracked) on a multi-track recorder.	Provides a vibe that is similar to chorus without the subtle swirl.
12	Echo	A single-repeat echo, not as fast as the Doubler. This effect provides a single, relatively rapid delay of the original signal, with the added warmth that vintage tape-based echo units provided.	Also known as Slap Back Echo, use it to make a vocal or guitar stand out in the mix without extra volume.
13 14 15	DLY 1 (Fast) DLY 2 (Med) DLY 3 (Slow)	These three presets provide delay with delay times of fast, medium and slow.	These work best with full, up-beat music like rock where the delay needs to cut through the mix.
16	Pan Delay	This fast delay bounces signal back 'n' forth from Left to Right and back again. Overall decay time is shorter than DLY 1-3.	This works best in a stereo mix.

ProFXv2 Series Limited Warranty

Please keep your sales receipt in a safe place.

This Limited Product Warranty ("Product Warranty") is provided by LOUD Technologies Inc. ("LOUD") and is applicable to products purchased in the United States or Canada through a LOUD-authorized reseller or dealer. The Product Warranty will not extend to anyone other than the original purchaser of the product (hereinafter, "Customer," "you" or "your").

For products purchased outside the U.S. or Canada, please visit www.720trees.com/warranty to find contact information for your local distributor, and information on any warranty coverage provided by the distributor in your local market.

LOUD warrants to Customer that the product will be free from defects in materials and workmanship under normal use during the Warranty Period. If the product fails to conform to the warranty then LOUD or its authorized service representative will at its option, either repair or replace any such nonconforming product, provided that Customer gives notice of the noncompliance within the Warranty Period to the Company at: www.720trees.com/support or by calling LOUD technical support at 1.800.898.3211 (toll-free in the U.S. and Canada) during normal business hours Pacific Time, excluding weekends or LOUD holidays. Please retain the original dated sales receipt as evidence of the date of purchase. You will need it to obtain any warranty service.

For full terms and conditions, as well as the specific duration of the Warranty for this product, please visit www.720trees.com/warranty.

The Product Warranty, together with your invoice or receipt, and the terms and conditions located at www.720trees.com/warranty constitutes the entire agreement, and supersedes any and all prior agreements between LOUD and Customer related to the subject matter hereof. No amendment, modification or waiver of any of the provisions of this Product Warranty will be valid unless set forth in a written instrument signed by the party to be bound thereby.

Need help with your mixer?

- **Visit www.720trees.com and click Support to find: FAQs, manuals, addendums, and other useful information.**
- **Email us at: techmail@loudtechinc.com.**
- **Telephone 1-800-898-3211 to speak with one of our splendid technical support chaps (Monday through Friday, normal business hours, Pacific Time).**



16220 Wood-Red Road NE
Woodinville, WA 98072 • USA
Phone: 425.487.4333
Toll-free: 800.898.3211
Fax: 425.487.4337
www.720trees.com

Free Manuals Download Website

<http://myh66.com>

<http://usermanuals.us>

<http://www.somanuals.com>

<http://www.4manuals.cc>

<http://www.manual-lib.com>

<http://www.404manual.com>

<http://www.luxmanual.com>

<http://aubethermostatmanual.com>

Golf course search by state

<http://golfingnear.com>

Email search by domain

<http://emailbydomain.com>

Auto manuals search

<http://auto.somanuals.com>

TV manuals search

<http://tv.somanuals.com>