

## Copyright

Copyright © 2005 by Xsense Connectivity, Inc. (dba Macsense Connectivity). All rights reserved. No part of this documentation may be reproduced in any form or by any means or used to make any directive work (such as translation or transformation) without permission from Xsense Connectivity, Inc. Xsense Connectivity, Inc. reserves the right to revise this documentation and to make changes in content without obligation among Xsense Connectivity, Inc. to provide notification of such revision or change. All products and their associated features are subject to change or upgrade at the time of the shipment or of the sales.

## FCC Notice

This equipment has been tested and found to be FCC Rules certified. These restrictions are designed to provide protection against harmful interference from residential installations. This equipment generates radio frequencies that may cause interference with radio communications if not used in accordance with the instructions. Interference may even occur during proper installation. If this equipment causes interference, the user is suggested to correct it by one or more of the following:

- Reorient or relocate the receiving antenna.
- Increase the separation between the equipment and receiver.
- Connect the equipment into an outlet on a circuit that is separate from the one to which the receiver is connected.
- Consult the dealer or an experienced radio/television technician for help.

## CE Declaration of Conformity

The equipment complies with the requirements relating to electromagnetic compatibility, the essential protection requirement of Council Directive/EEC on the approximation of the Member States relating to Electromagnetic compatibility.

## Trademarks

All products and brand names are trademarks and/or registered trademarks of their respective companies.

## Safety Precautions

- Follow all warnings and instructions marked on the product.
- Slots and openings on the device are provided for ventilation. To protect it from overheating, these openings must not be blocked or covered.
- Do not use or store this product in the environment that exceeds temperature and humidity specifications. Do not place this product near a radiator or heat register, or in a built-in installation unless adequate ventilation is provided.
- Before cleaning, unplug this product from wall outlet. Do not use liquid cleansers or aerosol cleansers. Use a damp cloth for cleaning.
- Do not place cords or cables where they may be walked on or tripped over.
- Be sure to comply with any applicable local safety standards or regulations.
- General-purpose cables are provided with this product. The use of any other cables or requirements mandated by local authority is user's responsibility.
- Cables attached to devices in different locations with different power sources and grounding may cause hazardous voltage. Consult a qualified electronic consultant before installing the product to check if this phenomenon exists and, if necessary, take corrective action.
- Never touch un-insulated telephone wires or terminals unless the line has been disconnected.
- Avoid using telephone equipment or installing the product during an electrical storm.
- Never install this product, or any kind of telephone jacks, lines, network cables, or power connections in wet locations.
- Never spill liquid of any kind on this product



# TABLE OF CONTENTS

<b>1.0 INTRODUCTION .....</b>	<b>3</b>
1.1 Benefits .....	3
1.2 Features .....	3
1.3 Ideal Applications .....	4
1.4 Wireless Network Planning .....	6
<b>2.0 BEFORE YOU START.....</b>	<b>9</b>
2.1 Package Contents .....	9
2.2 System and Other Requirements .....	9
<b>3.0 GETTING TO KNOW YOUR AEROPAD MINI .....</b>	<b>11</b>
3.1 Front LED's and Back Panel .....	11
3.2 Installation .....	12
3.3 Hardware Reset .....	12
<b>4.0 Basic Configuration.....</b>	<b>13</b>
4.1 Manually setting TCP/IP Values .....	13
4.1.1 Mac OS X 10.x.....	14
4.1.2 Mac OS 8/9 .....	15
4.1.3 Windows 2000/XP .....	15
4.1.4 Windows 95/98/ME .....	17
4.2 Access the Web-Config Pages .....	18
4.2.1 Configure using the included Setup Wizard .....	19
4.3 Activating AeroPad Mini.....	22
<b>5.0 WEB-CONFIG PAGES .....</b>	<b>23</b>
5.1 Status .....	23
5.2 Basic Setting .....	24
5.3 IP Setting.....	25
5.5 Advanced Setting .....	27
5.6 Security .....	28
5.7 Tools.....	28
<b>6.0 TROUBLESHOOTING .....</b>	<b>31</b>
6.1 Common Problems and Solutions .....	31
6.2 Glossary .....	33
<b>APPENDIX .....</b>	<b>37</b>
Specifications .....	37



---

## 1.0 INTRODUCTION

Congratulations on your purchase of the **Macsense AeroPad Mini**, the **802.11g Ethernet Adapter for Mac/PC**. Welcome to the Macsense/Xsense Product Family.

A fast growing trend today is wireless networking. By going wireless you reduce the hassle of cable clutter, the expensive need to run cabling in the home or office and the aggravation altogether to crawl under that desk for the last time to see if that Ethernet cable is connected. The convenience of where and when you want to connect to your network or Internet is now yours! Situate your computer in the most convenient location without regards to whether there is an access point or router nearby.

AeroPad Mini follows a WLAN standard called IEEE. The 802.11g standard has emerged delivering speeds of up to 54Mbps and the ability to take the power of the Internet with you. Imagine the ease and speed of which you can connect to your wireless network and to the Internet.

The AeroPad Mini is a perfect solution for those older computers, such as the iMac and iBook, without a wireless solution, the AeroPad Mini gives them the wireless capability they deserve.

AeroPad Mini (WUA-800) is an improvement on its predecessor, the AeroPad Plus (WUA-700).

AeroPad Mini is specifically designed for Small Office and Home Office needs. It provides a complete SOHO solution for Internet surfing, and is easy to configure and operate even for non-technical users. Instructions for installing and configuring AeroPad Mini can be found in this manual. Before you install and use AeroPad Mini, please read this manual carefully to take full advantage of AeroPad Mini.

### 1.1 Benefits

- Eliminates the clutter, hassle, and cost of cabling.
- Longer operating range gives you more room to move around.
- Supports any desktop or laptop, Mac or PC with an Ethernet port and USB port.
- WEP/WPA-PSK encryption provides the highest security.
- Compatible with Apple AirPort Base Station and all 802.11g/b-compliant access points.

### 1.2 Features

- Interoperable with IEEE 802.11g/b 2.4GHz-compliant devices.
- *Low power consumption* <less than 460 mA>, and *supports power over USB* which provides the best mobility.
- High-speed data transfer rate of 54,48,36,24,18,12,11,9,6, 5.5, 2 and 1

Mbps

- Auto-fallback to lower data rate in noisy environments.
- Achieving data rate up to *54Mbps* for 802.11g and *11Mbps* for 802.11b with wide range coverage.
- AeroPad Mini supports and Mac OS 7, 8, 9 and OS X, Windows 98, Me, 2000, XP.
- No driver or software installation required.
- Supports computer-to-computer (ad-hoc) connection without an access point.
- Works with all standard Internet applications.

---

**Note: Maximum wireless signal rate based on IEEE Standard 802.11g specifications. Actual data throughput will vary. Network conditions and environmental factors lower actual data throughput rate.**

---

### 1.3 Ideal Applications

There are basically two types of wireless networks: Infrastructure and Ad-hoc. An **Infrastructure** network uses one or more access points (such as the Macsense XRouter Aero, or Apple AirPort Base Station) as a gateway, linking the wireless network to a wired LAN. As a result, computers on your wireless network have access to all the features of your wired LAN including email, Internet access, network printers and file servers.



This is in contrast with another related wireless topology, called **Ad-hoc** network, in which each wireless workstation communicates with one another without the existence of an access point.

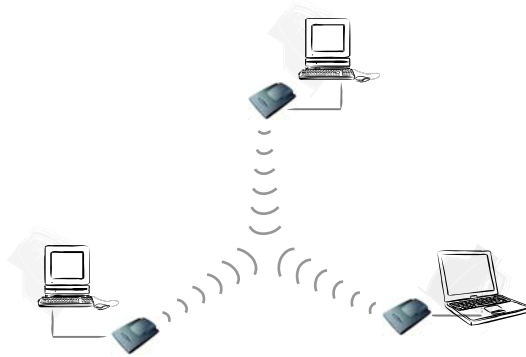

Although Ad-hoc allows for wireless connection between computers without an access point, it is Infrastructure with its central wireless access point that will be the most common.

### Other Applications

The AeroPad Mini is the perfect wireless 802.11b/g solution for computers that are not wireless ready. But since no drivers are required for the AeroPad Mini, it can be extended beyond computers, for use with ANY device with an Ethernet port. These Ethernet devices include game consoles like Xbox and PlayStation 2, and DVRs such as Tivo.

These Ethernet devices no longer are restricted by long Ethernet cable clutter to connect to the internet. With AeroPad Mini, now these devices can be placed anywhere in the house.

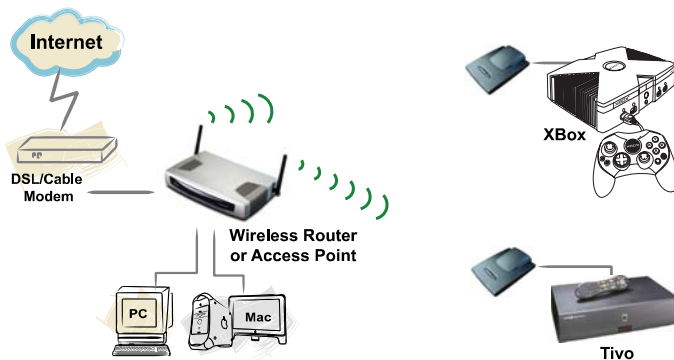

The AeroPad Mini unwires game console by connecting two consoles together wirelessly. Configure the AeroPad Mini in ad-hoc mode for peer-to-peer data transmission, or configure it to infrastructure mode to connect to the internet and

join multiple-player games.

TiVo has a built in Ethernet port which can be connected to the AeroPad Mini. This will allow the TiVo to connect wirelessly to the local network, allowing it to access media content (music, photos, and video) on your computer or on the Internet. AeroPad Mini simplifies connection by eliminating long cable clutter.

## 1.4 Wireless Network Planning

Although the arrival of affordable wireless technologies has provided a great deal of flexibility in how you connect to the Internet, there still is some needed planning in setting up a WLAN network.

A WLAN can in some respects be considered much like a wired network with the exception that wireless adapters will transmit the data over radio frequency waves instead of within a shielded Ethernet cable. Because of this, the initial location of the Access Point or wireless router is extremely important. Situating the AeroPad Mini so that it has the least amount of obstruction is highly advisable.

The setup of all wireless devices involved is quite important, as they should share the same radio channel and ESSID. Without these common settings, they will not be able to communicate with one another. Any additional encryption settings for security measures must be configured identically on all devices to accept the data transfer.

One of the greatest advantages is the adaptability of a wireless network. You can easily move a desktop computer within a room or to an entirely different room or floor without restrictions of an Ethernet cable. This, however, does take proper and precise planning of where to locate your access point(s) and how to overlap them so as to provide full wireless range.

Some other points to follow when planning a wireless network:

1. Minimize obstructions of the 802.11g/b RF waves
  - a. Centrally locate the Wireless Router or access point. All obstructions will weaken the signal to some degree.
  - b. Certain building materials (metals, concrete, etc.) should be avoided by the signal.
2. Situate the wireless devices so as to maximize signal output and reception
  - a. Situate the WLAN devices so the signal is going straight through the walls instead of at an angle.
  - b. Stay clear (3 – 5ft.) of devices that introduce “noise” to the reception, such as microwaves, monitors, etc.
  - c. Position the antenna to maximize RF signal output. If the antenna is internal, position the unit in different directions to maximize reception.
  - d. Additional access points can be placed in areas of low or no signal reception.

---

**Note: The new 802.11g/b wireless protocol has limitations as to how far the wireless**



***range can reach. Take your time to plan your wireless network properly to help provide the best range. Each obstruction can and will diminish the signal strength. So bare this in mind when planning and implementing your wireless network.***

---



---

---

## 2.0 BEFORE YOU START

Before you start using the AeroPad Mini, check for package contents and make sure you have the system requirements to use the AeroPad Mini.

### 2.1 Package Contents

- One AeroPad Mini 802.11g Ethernet Adapter
- One RJ-45 Ethernet cables
- One USB Power Cable
- One CD containing the User Manual
- Quick Start Guide

### 2.2 System and Other Requirements

- Windows 95/98/Me/2000/XP or that of later versions
- Mac OS 7.5.3 or later versions including OS X (including 10.4 Tiger)
- Computer with 10/100Mbps Ethernet port to support TCP/IP protocol
- One available USB port
- Apple Safari, Microsoft Internet Explorer, Netscape Navigator web browsers with JavaScript enabled

---

***Note: If you have access points installed on your network, you will need the following information to configure your WUA-800 AeroPad Mini: SSID (Service Set Identifier), the name of the access point in use, and Encryption, any passwords or keys used by your access point for Wireless Encryption (WEP).***

---



---

---

## 3.0 GETTING TO KNOW YOUR AEROPAD MINI

This chapter first gives a description of the LED indicators and ports of the AeroPad Mini. Then it outlines the steps in connecting the unit to your computer.

### 3.1 Front LED's and Back Panel



#### LED's:

- Power LED: ON when the unit is powered up
- LAN LED: ON indicates LAN connection; BLINK indicates LAN activity
- WLAN LED: ON indicates WLAN is working; BLINK indicates wireless activity.

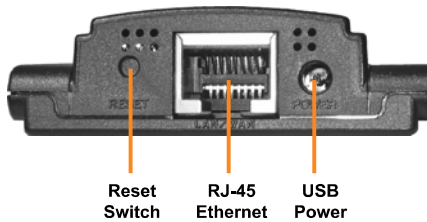

#### Ports:

- USB Power Jack: Obtain power from the host computer's USB port.
- Reset Switch: Use to reset the AeroPad Mini back to factory default settings.
- RJ-45 Ethernet Port: Connects to the Ethernet port of the host computer.

### 3.2 Installation

To connect AeroPad Mini to your computer, following the step below:

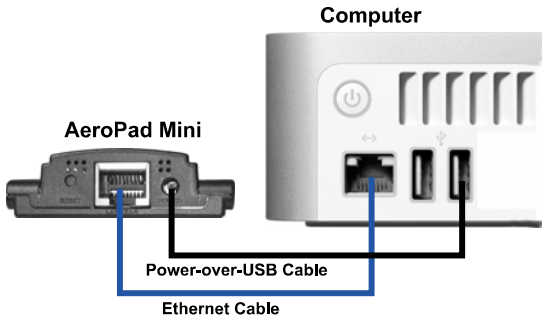

1. Plug one RJ-45 connector of the enclosed Ethernet cable to the Ethernet port on your computer; plug the other RJ-45 connector to AeroPad Mini's Ethernet port.
2. Take out the USB Power cable. Plug the USB connector into a USB port on the computer, and then plug the other end into the AeroPad Mini's power port. This will provide the AeroPad Mini with the required power to operate.
3. Make sure the switch on the base of the AeroPad Mini is set to "Client" mode (default position). AeroPad Mini would not work if it is set in any other position.



### 3.3 Hardware Reset

There may come a time when AeroPad Mini needs to do a hardware reset to return all settings to factory defaults. Note that all users settings will be replaced in a hardware reset. To do hardware reset,

1. While AeroPad Mini is powered, use a pin to poke into the Reset Switch. Push and hold for 4 seconds then release.
2. After release, the LAN and WLAN LEDs should go off and begin a reset process. Wait for all LEDs to settle as solid green. It may take up to 10 seconds for the process to complete.
3. Reset is now complete. There is no need to re-power the AeroPad Mini or your computer afterwards.

---

## 4.0 Basic Configuration

AeroPad Mini does not require drivers to be installed into your system. AeroPad Mini is configured by using any web browser (e.g. Safari, Internet Explorer, and Netscape) from your computer and accessing AeroPad Mini's *internal* configuration web pages (hereafter referred to as "web-config pages").

As with any wireless adapter, you will need to configure the AeroPad Mini before it can connect to your wireless network. Mainly, AeroPad needs to know what the *Network Name (SSID)* and the *WEP Key* (if your network is encrypted) are.

A typical network diagram for a wireless network is pictured below. AeroPad Mini is connected to a computer, giving it wireless capability. A wireless router or access point is connected to the DSL/Cable modem, and accessing the Internet. The AeroPad Mini is constantly communicating with the access point wirelessly, thereby accessing the local network resources or the Internet.

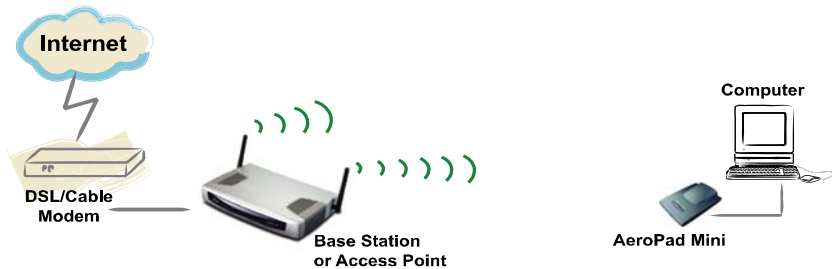

---

**Note: Wireless Router is an Access Point plus a Router. Access Point is sometimes also referred to as Base Station.**

---

To access and configure AeroPad Mini's web-config pages, following the steps below.

1. Set your computer's TCP/IP values *manually* to "192.168.1.2", Subnet Mask "255.255.255.0", and Gateway and DNS to "0.0.0.0". Refer to Section 4.1 on how to do this for each OS.
2. Use a web browser to access and configure the AeroPad Mini using the built in Setup Wizard that is included in the web-config pages. The Setup Wizard will ask for your basic wireless network information so AeroPad Mini can connect your computer to the access point. Refer to Section 4.2 for detail instructions.
3. Change your computer's TCP/IP settings back to "Acquire IP automatically" will activate AeroPad Mini and bring your computer online wirelessly. Refer to Section 4.3 for detail instructions.

### 4.1 Manually setting TCP/IP Values

The default IP address of the AeroPad Mini is "192.168.1.50". In order to access the AeroPad Mini web-config pages, you will need to first set your computer to have a fixed IP of "192.168.1.2", a Subnet of "255.255.255.0", and no Gateway

or DNS. Follow the instructions below for each OS.

### 4.1.1 Mac OS X 10.x

1. In the Finder click on the *Apple* menu and select **System Preferences**.



2. Under the *Internet and Network* section, click the **Network** icon.



3. Select the *TCP/IP* tab.
4. Click on the *Location* menu and select "Automatic"
5. Click on the *Show* menu and select "Built-in Ethernet".



6. Click on the *Configure* menu and select "Manually" (If "Manually" is not available, click on the *PPPoE* tab and uncheck "Connect using PPPoE"), click Apply Now, now select the TCP/IP tab. Click on the *Configure* menu and select "Manually".
  - a. In the *IP Address* field, enter "192.168.1.2".
  - b. In the *Subnet Mask* field, enter "255.255.255.0". (If the Subnet Mask field is not available click on the PPPoE tab and uncheck Connect using PPPoE, click Apply Now, now select the TCP/IP tab.)
  - c. Click **Apply Now** button at the bottom right hand corner of the System Preferences.
7. Close *System Preferences* window.

#### 4.1.2 Mac OS 8/9

1. Select and open TCP/IP from Control Panels under the Apple menu.

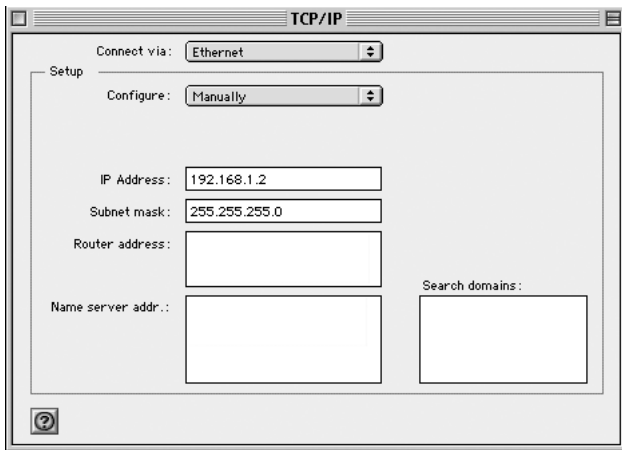

2. In the **Connect via** menu, select the **Ethernet Interface** installed in your computer.
3. In the **Configure** menu, select "Manually".
  - a. In the **IP Address** field, enter the IP address of "192.168.1.2".
  - b. In the **Subnet Mask** field enter "255.255.255.0".
  - c. Close the **TCP/IP** window and save the changes.

#### 4.1.3 Windows 2000/XP

1. Click the **Start** button, open the **Control Panel**. Click the **Network Connections** icon to open the "Network Connections" window.
2. Double click on the **Local Area Connection** icon for the applicable Ethernet adapter (usually it is the first Local Area Connection listed). The "Local Area

"Connection Properties" windows will open.

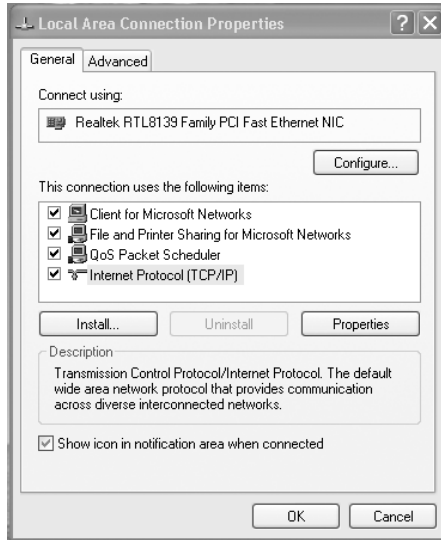

3. Select "Internet Protocol (TCP/IP)" item and click the **Properties** button.

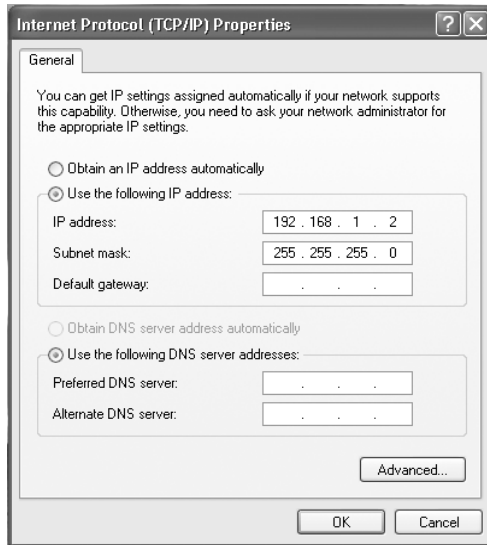

4. Select "Use the following IP address" option.
  - a. In the *IP Address* field, enter "192.168.1.2"
  - b. In the *Subnet Mask* field, enter "255.255.255.0"
  - c. Leave *Default gateway*, *DNS* fields empty.

6. Click the **OK** button in the *Internet Protocol (TCP/IP) Properties* window.
7. Click the **OK** button in the *Local Area Connection Properties* window.

#### 4.1.4 Windows 95/98/ME

1. Double-click the **Control Panel** icon in *My Computer* folder or locate it in the Start Menu. The sub-folder Control Panel is located under Settings.
2. In the Control Panel, double-click the **Network** icon. The network interface card (installed on your computer) appears along with the network protocol on the Configuration list.

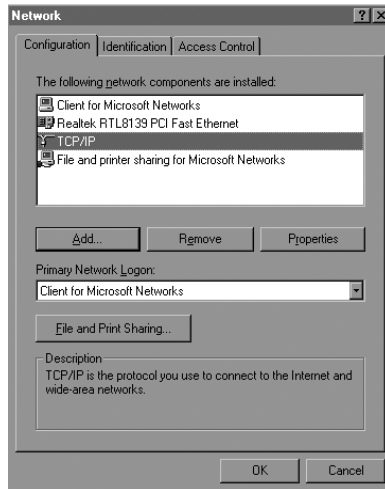

3. Double-click **TCP/IP protocol** on the list. If TCP/IP does not appear on the list, install the TCP/IP protocol first as illustrated in step 4. Clients with TCP/IP already installed may skip to step 5.
4. To install the TCP/IP protocol:
  - a. Keep your copy of Windows 95/98/Me CD-ROM on hand. (You will need it for this installation.)
  - b. Click the **Add** button from the Configuration list of the Network window. A new window will appear.
  - c. Double-click **Protocol**. Then, in the *Select Network Protocol* window, choose **Microsoft** on the *Manufacturers list*, and select **TCP/IP** on the right side of the list.
5. Follow the instructions on the screen to complete the installation process. It should prompt for a restart and then follow on with step 6, as you will now find a TCP/IP Protocol in your Network control panel.
6. After double-clicking the installed TCP/IP protocol, the *TCP/IP Properties* window appears. To have the XRouter Aero Plus automatically assign computers a correct TCP/IP configuration please follow the steps:

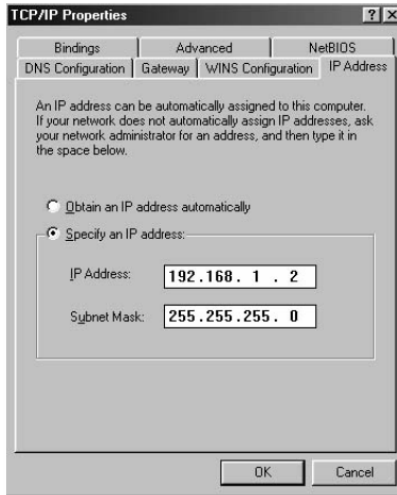

- a. Click the **IP Address** tab from the *TCP/IP Properties* window.
  - b. Select the item **Specify an IP address** to manually input unique **IP address** and **Subnet Mask**. In the IP Address field enter "**192.168.1.2**" where x is any variable of your choice ranging from 1 - 253. (We suggest assigning "1")
7. After specifying the settings of TCP/IP click OK and restart Windows to allow the settings to take effect.

## 4.2 Access the Web-Config Pages

---

**Note:** Before we continue please refer to the previous Section and make sure that you have completed the manual TCP/IP settings on your computer.

---

After your computer has been set to a manual IP Address, we can now access the AeroPad Mini's web-config pages.

Accessing and configuring the AeroPad Mini is done using any web browser (such as Apple Safari, Microsoft Internet Explorer, or Netscape Navigator).

1. Launch your web browser of choice.
2. In the URL field, type "http://192.168.1.50" and press the Enter key. "192.168.1.50" is the default fixed IP of AeroPad Mini.
3. When prompted for a username and password, type "admin" for both the username and password. "admin" is the default username and password to access AeroPad Mini's web-config pages, and it can be changed after login.



**Note: Password is case sensitive so verify that Caps Lock is off.**

4. After successful logon, an AeroPad Mini Status window will appear below.

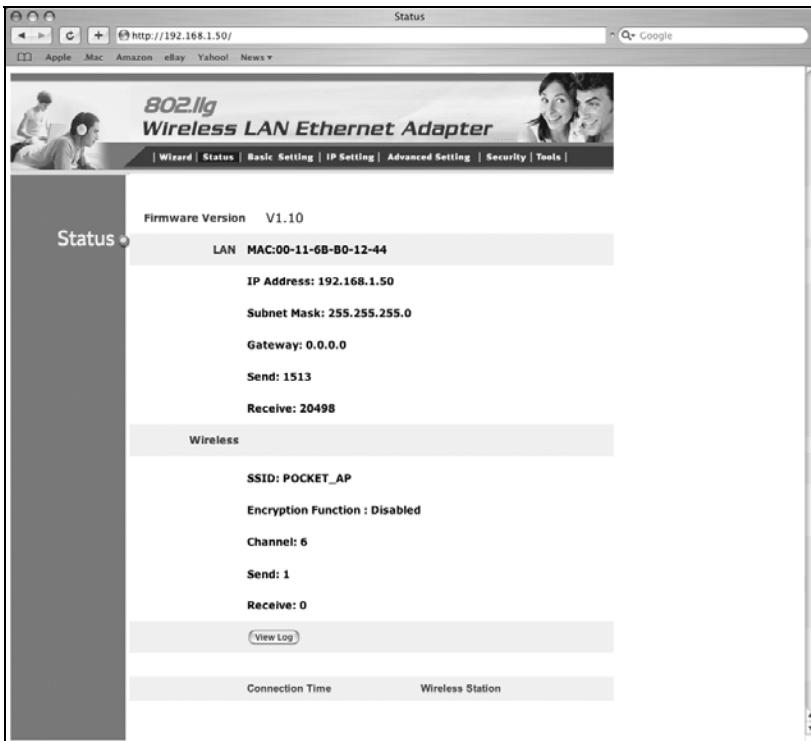

5. If the window does not appear, check your cable connections and TCP/IP settings. Also, see the Troubleshooting Section.

### 4.2.1 Configure using the included Setup Wizard

The AeroPad Mini contains a simple Setup Wizard that is provided as part of the web configuration utility. You can simply follow the step-by-step process to allow the AeroPad Mini to connect to your wireless network there are 4 easy setup

steps that you can access using the built in Wizard.

1. Click the “**Wizard**” button in the function menu. The following screen will appear: Click “**Next**” to continue.

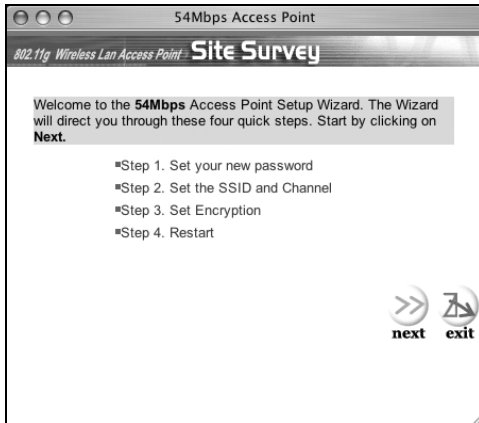

2. **Set Password** – Here you can change the Admin account password of the AeroPad Mini, this is referring to the admin password that was used to log in. After you do you this please click “**Next**” to continue.

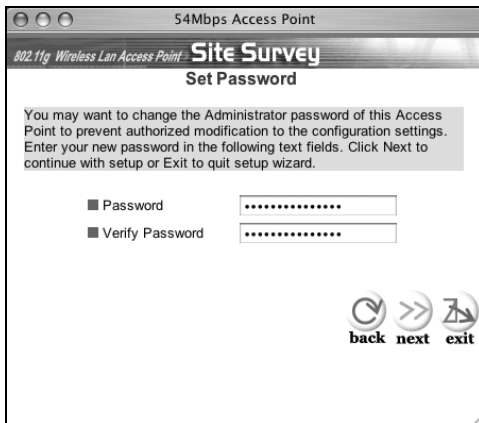

3. **Set Wireless LAN Connection** – Enter the SSID/Network Name of your wireless network here, the default ESSID is “default”. Also you can change the channel if you have your access point/base station on a different channel. Please click “**Next**” to continue.

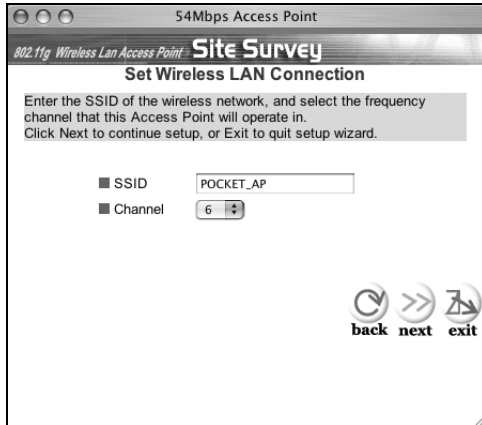

- 4. Set WEP Encryption** – If the wireless network has WEP enabled then you will have to enable WEP on the AeroPad Mini, please click **“Enabled”**. Then, select ether 64 or 128-bit WEP encryption and enter the network HEX key value in the key text box. Click **“Next”** to continue.



5. **Restart** - The Setup wizard is now completed. The new settings will take effect after the AeroPad Mini is restarted. Please click "**Restart**" to reboot the AeroPad Mini. If you wish to exit the Setup wizard without making/saving any changes click the "**Exit**" button. Also you can go back to modify any previous entries by clicking the "**Back**" button.

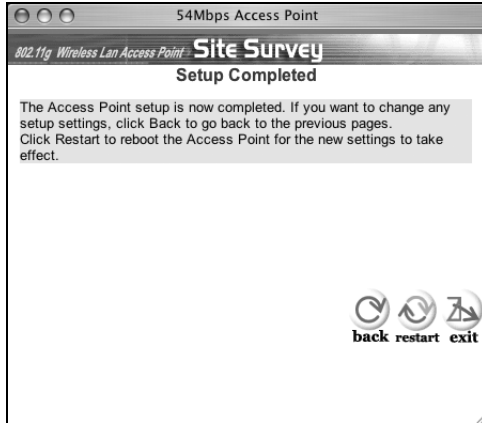

### 4.3 Activating AeroPad Mini

After AeroPad Mini is configured, the next step is to activate AeroPad Mini and get your computer online.

1. Return your computer's TCP/IP settings to "Obtain IP Automatically".
2. Reboot your computer.



---

## 5.0 WEB-CONFIG PAGES

From the last chapter, you have learned how to access the web-config pages and how to use the Setup Wizard to perform basic configuration on the AeroPad Mini. For most users, that's all that is required to access the wireless network successfully.

We will now explain all the other features of the AeroPad Mini. These web-config pages are a little more in-depth and provide the user with more information and control.

### 5.1 Status

The Status page provides read-only information on the working status of the AeroPad Mini. It displays information about the Ethernet connection between the computer and AeroPad Mini and it also shows the wireless connection going to the wireless network.

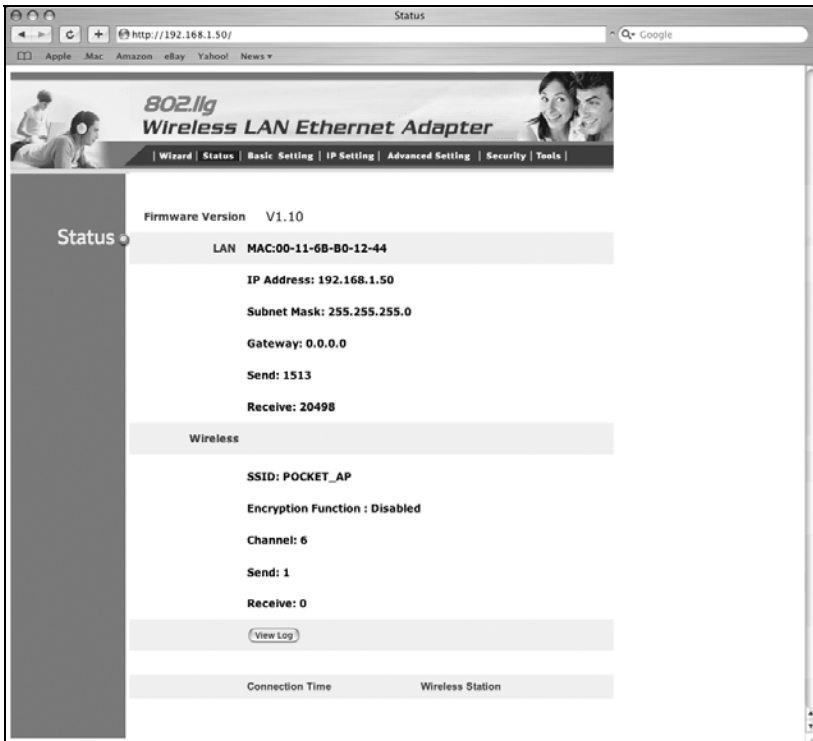

The screenshot shows a web browser window displaying the 'Status' page of the 802.1lg Wireless LAN Ethernet Adapter. The browser address bar shows 'http://192.168.1.50/'. The page has a navigation menu with 'Wizard', 'Status', 'Basic Setting', 'IP Setting', 'Advanced Setting', 'Security', and 'Tools'. The main content area is titled 'Status' and displays the following information:

Firmware Version	V1.10
LAN	MAC:00-11-6B-80-12-44
	IP Address: 192.168.1.50
	Subnet Mask: 255.255.255.0
	Gateway: 0.0.0.0
	Send: 1513
	Receive: 20498
Wireless	
	SSID: POCKET_AP
	Encryption Function : Disabled
	Channel: 6
	Send: 1
	Receive: 0
	<a href="#">View Log</a>
Connection Time	Wireless Station

**Firmware Version:** Shows the current firmware version of AeroPad Mini.

**LAN:** Shows the MAC Address, IP Address (default: 192.168.1.50), Subnet Mask, and Gateway Address. The current LAN traffic calculated in terms of

number of packets sent and received by AeroPad Mini through the wired connection is also displayed.

**Wireless:** Shows the MAC address, current ESSID, the status of Encryption Function (Enable or Disable), the current channel that is being used. The current wireless traffic that is being sent and received by the AeroPad Mini is also displayed.

**View Log:** When clicked, a log page is displayed. The log page records every event and the time that it happens. The entries can be cleared by clicking the "Clear Log" button, or to refresh the screen and see the latest log entries click the "Refresh" button.

## 5.2 Basic Setting

The Basic Setting page is the most important, initial setup page for the wireless function of AeroPad Mini. Most of the settings will already be configured by the Setup Wizard you used from the last Chapter. But you are also able to review and set all the values manually here in this page.

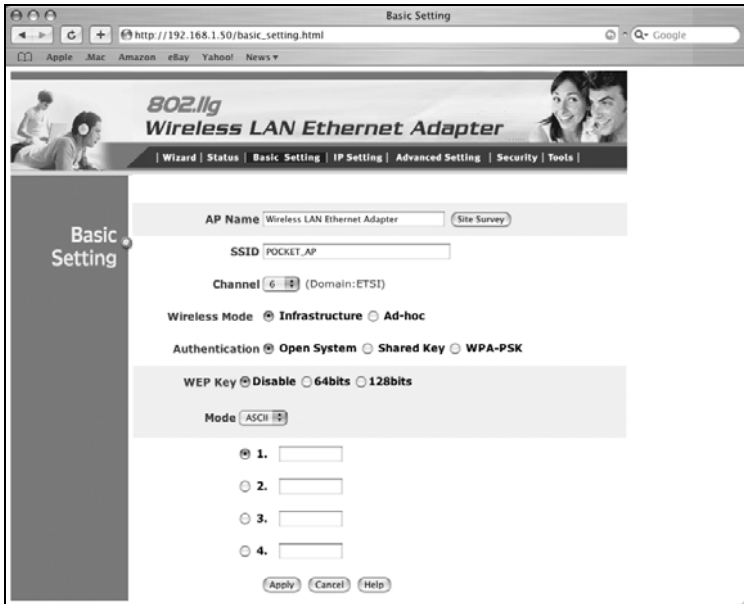

**AP Name:** The name of the AeroPad Mini, as it is recognized by the wireless network. The default name is "Wireless LAN Ethernet Adapter". If you have multiple computers each using an AeroPad Mini, then you can set each AeroPad Mini to have a unique name.

**SSID:** Also referred to as the "Network Name", it is a unique name that identifies the wireless network. Each clients and nodes in the same wireless network must have the same SSID. Default is "POCKET\_AP".

**Channel:** This is the channel that AeroPad Mini will operate on. The channel selection can range from 1 to 11 for North America (FCC) domain, 1 to 13 for European (ETSI) domain and 1 to 14 for Japanese domain.

**Wireless Mode:** The topology of your wireless network. If your wireless network has an access point, then set the Wireless Mode to "Infrastructure". If you are connecting computer-to-computer, without the existence of an access point, then set the Wireless Mode to "Ad-Hoc". Default is "Infrastructure".

**Authentication Type:** If your wireless network is protected with encryption, then the authentication type must be selected here. There are three options for authentication type: "Open System", "Shared Key", and "WPA-PSK". Default is "Open System".

---

**Note:** *The AeroPad Mini must use the same authentication type and WEP Key as the access point is configured for, otherwise the AeroPad Mini will fail to connect to the wireless network.*

---

For both the "Open System" and "Shared Key" authentication, a **WEP Key** is required. The key can be 64 or 128-bits.

Using WEP encryption on a wireless network can protect your data while it is transferred from AeroPad Mini to the access point. However, network performance is lower because the access point must decode and encode each piece of data moving from and to your AeroPad Mini.

**Mode:** There are two types of methods for entering the WEP encryption key, "HEX" and "ASCII".

A Hexadecimal WEP key is comprised of any number 0 through 9 and/or letter A through F. A 64-bit key requires 10 hex digits, or a 128-bit key requires a 26 hex digit. Example of a 64-bit and 128-bit hex keys are "AB843E72DF" and "ABCDEF12345678901234567890", respectively.

An ASCII WEP key is made up of any number 0 through 9 and/or letters A through Z.

**1, 2, 3 and 4:** WEP key is entered in either one of the four the key slots. The slot number has to match the WEP key slot defined in the access point.

If **WPA-PSK** is enabled, user needs to set the key in the Passphrase field. The key length should be 8 characters at least. Once WPA-PSK function enables, it will take some time to make the setting active.

**Apply:** Click the "Apply" button to save any of the changes that were done to the AeroPad Mini. The changes have been saved and will be effective once the AeroPad Mini is restarted.

**Cancel:** Click the "Cancel" button to clear any changes.

### 5.3 IP Setting

This page configures the **IP Address** of the AeroPad Mini. This is also the IP Address by which you use a web browser to access the web-config pages of the AeroPad Mini. It is very important that you know the IP Address of the AeroPad Mini, because otherwise, you won't be able to configure AeroPad Mini any more.

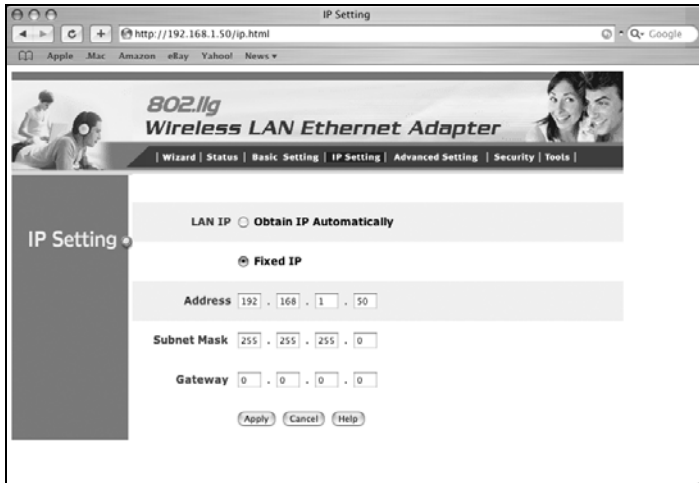

## Default AeroPad Mini Fixed IP Address

By default, the AeroPad Mini is set to a **Fixed IP** address. The default IP Address is "192.168.1.50" (Subnet Mask "255.255.255.0", and Gateway "0.0.0.0"). For most home users, there is no need to change its value.

### Changing AeroPad Mini's Fixed IP Address

But you may wish to change the default fixed IP Address of AeroPad Mini for the following reasons:

- Your local wireless network is in an IP domain other than "192.168.1.x" (x being any number from 1 to 255). If your local wireless network has an IP domain of "192.168.2.x" or "10.0.1.x", you may wish to change the default IP Address of AeroPad Mini to "192.168.2.50" or "10.0.1.50", respectively, so you can have access to the web-config pages of AeroPad Mini from your computer while your wireless network is active.
- Your local wireless network already has "192.168.1.50" assigned to an important resource, and you require AeroPad Mini to use another Fixed IP.

### Obtain AeroPad Mini IP Address Automatically

The AeroPad Mini can also be set to obtain an IP Address from your access point (or a DHCP server) automatically. This setting is not recommended usually, as you will not be able to know the IP Address of the AeroPad Mini easily, and you will have no way of getting back to its web-config pages. But this setting may be desirable if you have multiple AeroPad Minis to manage (e.g. in a lab or classroom where multiple computers are each using an AeroPad Mini) and you prefer to let a centralized DHCP server to assign IPs, and you can refer to the DHCP Client List in the DHCP server to find out the IP of each AeroPad Minis.

## 5.5 Advanced Setting

This page contains configurations for advanced users. Most users will not need to change the settings. These changes affect the wireless performance and operating modes of the AeroPad Mini. Items on this page may help increase wireless performance if set correctly.

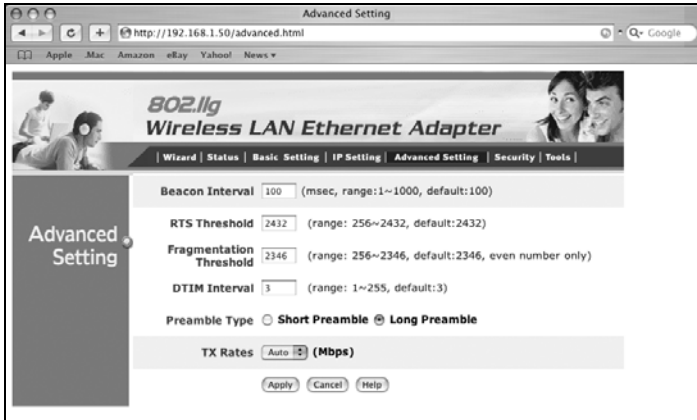

**Beacon Interval:** Sets the period of time in milliseconds that the AeroPad Mini sends out a beacon. The default is 100 milliseconds.

**RTS Threshold:** This is the size of RTS/CTS packet size. The default is 2432 bytes.

**Fragmentation Threshold:** Number of bytes used for the fragmentation boundary for directed messages. The default is 2436 bytes.

**DTIM Interval:** This indicates the interval of the Delivery Traffic Indication Message (DTIM). A DTIM field is a countdown field informing clients of the next window for listening to broadcast and multicast messages. When the access point has buffered broadcast or multicast messages for associated clients, it sends the next DTIM with a DTIM interval value. Access point clients hear the beacons and awaken to receive the broadcast and multicast messages.

**Preamble:** Select either a **Long** or **Short** Preamble type. The preamble is a sequence of bits transmitted at 1Mbps that allows the PHY circuitry to reach steady-state demodulation and synchronization of bit clock and frame start. Two different preambles and headers are defined: the mandatory supported Long Preamble and header, which interoperates with the 1 Mbit/s and 2 Mbit/s DSSS specification (as described in IEEE Standard 802.11), and an optional Short Preamble and header (as described in IEEE Standard 802.11b). At the receiver, the Preamble and header are processed to aid in demodulation and delivery of the PSDU. The Short Preamble and header may be used to minimize overhead and, thus, maximize the network data throughput. However, the Short Preamble is supported only from the IEEE 802.11b (High- Rate) standard and not from the original IEEE 802.11. That means that stations using Short-Preamble cannot communicate with stations implementing the original version of the protocol.

**TX Rates:** User also can fix the transmission at specific data rate, if choose “Auto” data rate, the Wireless Ethernet Adapter will change the data rate to have the best receive or transmit quality.

## 5.6 Security

This page sets the administrative username and password that are required to access the AeroPad Mini web-config pages. The default administrative username and password are both "admin". You can change them so no one can change your AeroPad Mini settings without your knowledge.



To change the administrator's username and passwords, follow the instructions below:

1. Enter the value in each field.
2. Repeat the same password the “**Confirm**” field.
3. Click “**Apply**”

## 5.7 Tools

The Tools page provides functions to maintain your current settings and perform firmware upgrade.



**Backup Settings:** To save the AeroPad Mini's current configuration to a file on your computer, click the "Backup" button.

**Restore settings:** To restore the AeroPad Mini to a previously saved configuration, click the "**Choose File**" button and select the file that was created when you backed up your settings. Select the saved file, click the "**Restore**" button. After the AeroPad Mini restarts the restore process is complete.

**Restore to default settings:** To restore the AeroPad Mini to factory defaults click the "**Default**" button.

---

**Note:** *Restore to default settings will clear all information that you have entered.*

---

**Firmware Upgrade:** This allows you to update your AeroPad Mini's firmware as they become available. Firmware updates may be release periodically to fix bugs or improve performance. Click on the "**Browse**" button to select the latest firmware file which you downloaded. After selecting the firmware file, click "**Upgrade**" and complete the firmware upgrade process. Once the AeroPad Mini restarts then the Firmware Upgrade process is complete.





---

---

## 6.0 TROUBLESHOOTING

This chapter provides solutions to problems that may occur during the installation and operation of the AeroPad Mini. Check the following symptoms and their possible causes before contacting Macsense Tech Support. Read the description below to solve your problems. If you can't find an answer here, check the Macsense website at [www.macsense.com](http://www.macsense.com).

### 6.1 Common Problems and Solutions

#### **My wireless network uses IP domain of "10.0.1.x", do I need to change AeroPad Mini's fixed IP to "10.0.1.50" in order to work?**

No, AeroPad Mini's default fixed IP of "192.168.1.50" is an IP for you to access its internal config-page from your computer. It does not need to be changed to the range of your wireless network in order for your computer to get online. Your computer will acquire an IP from the DHCP server (usually in the wireless router or access point) in the range of "10.0.1.x" normally, even though the AeroPad Mini continues to have a default fixed IP of "192.168.1.50".

#### **I change AeroPad Mini to acquire its IP automatically and now I can not access its web-config pages.**

It is not recommended to change AeroPad Mini's default fixed IP for this exact reason. If AeroPad Mini is to acquire its IP automatically, then the IP will no longer be its default fixed IP of "192.168.1.50" and you would have no clue what its new IP is. Without knowing new IP, you can not access its internal web-config pages any longer.

It is recommended only for advance users who have access to the DHCP Client List on your DHCP Server (usually on the wireless router or access point) to use this setting. From the DHCP Client List, you can check what IP the AeroPad Mini was assigned last, and be able to access its internal web-config pages using it.

If you have no access to the DHCP Client List, then your only option is to do a hardware reset of your AeroPad Mini, to return all settings to factory defaults. And as a result, your AeroPad Mini will be accessible again on the default fixed IP of "192.168.1.50".

#### **Why can I not access AeroPad Mini's web-config pages while I'm connected to the wireless network?**

You can not access the AeroPad Mini's web-config pages if your computer is not in the same IP domain as the AeroPad Mini. AeroPad Mini's default fixed IP is "192.168.1.50", so your computer will also need to be in the "192.168.1.x" domain in order to access AeroPad Mini's web-config pages.

When you're connected to the wireless network, your computer's IP is given by the DHCP Server (usually your wireless router or access point). If your computer's given IP is not in the range of "192.168.1.x" then you can not access AeroPad Mini's web-config pages. If you want to access AeroPad Mini's web-config pages while you're on the wireless network, you will need to change the AeroPad Mini to have the same IP domain as the wireless network. For example,

if your wireless router has an IP of "10.0.1.1", and your computer was given an IP of "10.0.1.101", then setting AeroPad Mini's fixed IP to "10.0.1.50" will make it accessible while your computer is online. You will just use a web browser and enter "http://10.0.1.50/" to access AeroPad Mini's web-config pages.

**If I have multiple AeroPad Minis in my wireless network, do I need to define each AeroPad Mini a unique fixed IP?**

No, AeroPad Mini has a default fixed IP of "192.168.1.50". This is the IP by which you use your browser to access its internal web-config pages. It is OK that each AeroPad Minis continues to have the same default fixed IP, even though multiple AeroPad Minis are being used in the same wireless network.

**Why my computer can not connect to the Internet?**

Access AeroPad Mini's web-config page and make sure that the correct SSID has been entered. If WEP is used, make sure the WEP key types (Open/Shared, 64/128-bit, Hex/ASCII, slots) are properly selected and entered. Both the SSID and WEP values should match the same in the access point of your wireless network.

Make sure that you have changed your PC's TCP/IP setting back to "Obtain an IP Address Automatically" after you completed configuration of the AeroPad Mini. If you are using a Mac, make sure it is set back to "Using DHCP".

## 6.2 Glossary

### **Access Point**

An internetworking device that seamlessly connects wired and wireless networks. Access points combined with a distributed system support the creation of multiple radio cells that enable roaming throughout a facility. In Macintosh terms, Access Point is also referred to as Base Station.

### **Ad-hoc**

An ad-hoc network is a local area network or other small network, such as wireless, in which some of the network devices are part of the network only for the duration of a communications session. In the case of mobile and portable devices, they can be a part of the network when in close proximity to the rest of the network.

### **Cable Modem**

A device that connects your PC to a local TV line and receives data at 1.5Mbps. One of its connections is connected to your PC and the other one is to the cable wall outlet. It attaches a standard 10BASE-T Ethernet card to a computer and modulates between digital and analog signals.

### **Cell**

Cell is the radio coverage area for a wireless device to communicate with an access point. The size of the cell can depend on the antenna, the speed of transmission, and the physical area.

### **Channel**

Each channel refers to a different frequency level allowing for multiple communication paths through one device, much the same way a radio operates.

### **Dynamic IP address**

A dynamic IP address is an IP address that is given out automatically from a DHCP Server to client computers or routers on a LAN or WAN.

### **Gateway**

An entrance to a network. It associates with both router and switch whereas the router gives direction as data arrives at the gateway and the switch, on the other hand, furnishes its actual path in and out of the gateway.

### **IEEE**

Abbreviation of Institute of Electrical and Electronics Engineers. Founded in 1884, the IEEE is an organization composed of engineers, scientists, and students. The IEEE is best known for developing standards for the computer and electronics industry. In particular, the IEEE 802 standards for local area networks are widely adopted.

### **IEEE 802.11 Standard**

In WLAN technology, 802.11 refers to standards set by the Institute of Electrical and Electronics Engineers. There are three specifications in the family, 802.11, 802.11a and 802.11b. 802.11 and 802.11b refer to wireless Ethernet LANs and

operate at frequencies around the 2.4 GHz range. 802.11 generally have data speeds of 1 or 2 Mbps while 802.11b can have speeds of 5.5 or 11 Mbps. 802.11b can also realize speeds up to 20 Mbps. 802.11a refers to wireless ATM systems and operates at frequencies between 5 to 6 GHz.

### **Infrastructure**

This type of network is a wireless or other type of small network where the wireless network devices are made a part of the network through the use of an access point. The access point connects the device to the rest of the network.

### **IP Address**

An identifier for a computer or device on a TCP/IP network. Networks using the TCP/IP protocol route messages base on the IP address of the destination. The format of an IP address is a 32-bit numeric address written as four numbers separated by periods. Each ranges from 0 to 255. For example, 157.124.10.1 could be a valid IP address.

### **ISM band**

The FCC and their counterparts outside of the U.S. have set aside bandwidth for unlicensed use in the ISM (Industrial, Scientific and Medical) band. Spectrum in the vicinity of 2.4 GHz, in particular, is being made available worldwide. This presents a truly revolutionary opportunity to place convenient high-speed wireless capabilities in the hands of users around the globe.

### **ISP (Internet Service Provider)**

An organization that provides access to the Internet. Small ISPs provide service via modem and ISDN while the larger ones also offer private line hookups (T1, fractional T1, etc.).

### **LAN (Local Area Network)**

A computer network that spans a relatively small area. Most LANs are confined to a single building or a group of buildings. However, one LAN can be connected to other LANs over any distance via telephone lines and radio waves. A system of LANs connected this way is called a wide-area network (WAN)

### **MAC Address (Media Access Control Address)**

On a network, it is a unique 48-bit number used in Ethernet data packets to uniquely identify an Ethernet device, such as an Ethernet adapter.

### **Protocol**

A set of rules that end points in a telecommunication use as they communicate. These end points must recognize and observe the protocol in the communication.

### **Radio Frequency**

Terms: GHz, MHz, Hz —The international unit for measuring frequency is Hertz (Hz), equivalent to the older unit of cycles per second. One megahertz (MHz) is one Million-Hertz. One gigahertz (GHz) is one Billion-Hertz. The standard U.S. electrical power frequency is 60 Hz, the AM broadcast radio frequency band is 0.55–1.6 MHz, the FM broadcast radio frequency band is 88–108 MHz, and

wireless 802.11 LANs operate at 2.4GHz.

### **Roaming**

The ability to use a wireless device and move from one access point's range to another access point without a drop or loss of connection.

### **Shared Key Algorithm**

In encryption, both the sender and the recipient use the same secret key to both encode and decode a message.

### **Spread Spectrum**

Spread Spectrum technology is a wideband radio frequency technique developed by the military for use in reliable, secure, mission-critical communications systems. It is designed to trade off bandwidth efficiency for reliability, integrity, and security. In other words, more bandwidth is consumed than in the case of narrowband transmission, but the trade off produces a signal that is, in effect, louder and thus easier to detect, provided that the receiver knows the parameters of the spread-spectrum signal being broadcast. If a receiver is not tuned to the right frequency, a spread-spectrum signal looks like background noise.

### **SSID (Service Set ID)**

A group name shared by every member of a wireless network. Only client PCs with the same SSID are allowed to establish a connection.

### **Static IP address**

A static IP address is an IP address that does not change and is manually set in client computer or router in a LAN or WAN.

### **TCP/IP**

Acronym for Transmission Control Protocol/Internet Protocol, the basic protocol of the Internet, which can be used as a communications protocol in a private network. Every computer that has direct access to the Internet has a copy of the TCP/IP program. TCP/IP uses the client/server model in which the user is the client that requests and is provided service by another computer, which is the server on a network. HTTP, FTP, Telnet, SMTP and other protocols are often packaged with TCP/IP as a "suite" in order to get to the Internet.

### **URL**

A URL (Uniform Resource Locator) is the address of a file (resource) accessible on the Internet. The URL contains the name of the protocol required to access the resource, a domain name that identifies a specific computer on the Internet, and a hierarchical description of a file location on the computer.

### **WLAN**

A WLAN in which a user can connect to a network using a wireless connection. IEEE 802.11 specifies the technology for WLANs, as well as the Wired Equivalent Privacy algorithm encryption method.

### **WEP (Wired Equivalent Privacy)**

A data privacy encryption method based on a 64-bit shared key algorithm.

**WEP Key**

A form of security and encryption used for WEP. It is a special sequence of characters used to restrict access to a wireless network.

---

# APPENDIX

## Specifications

**Model:** WUA-800

**Standards:** IEEE 802.11b, IEEE 802.11g, IEEE 802.3, IEEE 802.3u

**Device Management:** Web-Based Host Interface Ethernet RJ-45

**Signal Rate:**

(802.11g) 54, 48, 36, 24, 18, 12, 9 and 6Mbps

(802.11b) 11, 5.5, 2, and 1Mbps Security 64/128-bit WEP

WPA –PSK

MAC Address Filtering

SSID Broadcast Disable

**Wireless Frequency Range:** 2.412GHz to 2.462GHz

**Wireless Operating Range:**

802.11g (Full Power with internal antenna)

Outdoors:

164ft (50m) @ 54Mbps

492ft (150m) @ 11Mbps

656ft (200m) @ 6Mbps

**Power:** Power over USB port

**Radio and Modulation Type:**

(For 802.11g OFDM)

BPSK @ 6 and 9Mbps

QPSK @ 12 and 18Mbps

16QAM @ 24 and 36Mbps

64QAM @ 48 and 54Mbps

(DSSS)

DBPSK @ 1Mbps

DQPSK @ 2Mbps

CCK @ 5.5 and 11Mbps

(802.11b DSSS)

DBPSK @ 1Mbps

DQPSK @ 2Mbps

CCK @ 5.5 and 11Mbps

**Wireless Transmit Power:**

(For 802.11g)

31mW (15dBm) @ 54Mbps

40mW (16dBm) @ 48Mbps

40mW (16dBm) @ 36, 24, 18, 12, 9, and 6Mbps

(For 802.11b)

50mW (17dBm) @ 11, 5.5, 2, and 1Mbps

**Receiver Sensitivity:**

(For 802.11g)

6Mbps: -87dBm

9Mbps: -85dBm  
12Mbps: -82dBm  
18Mbps: -81dBm  
24Mbps: -80dBm  
36Mbps: -79dBm  
48Mbps: -71dBm  
54Mbps: -69dBm  
(For 802.11b)  
1Mbps: -90dBm  
2Mbps: -90dBm  
5.5Mbps: -86dBm  
11Mbps: -85dBm

**LEDs:** Power, LAN, WLAN

**Temperature:**

Operating: 32°F to 131°F (0°C to 55°C)  
Storing: -4°F to 149°F (-20°C to 65°C)

**Humidity:**

Operating: 10%~90% (non-condensing)  
Storing: 5%~95% (non-condensing)

**Certifications:** FCC, CE

**Dimensions:** 3 2/16" x 2 3/8" x 3/4" (8cm x 6cm x 1.7cm)

**Weight:** 2oz (50g)

**Warranty:** 1 Year

*Specifications subject to change without prior notice.*



## **MACSENSE STANDARD LIMITED WARRANTY**

Macsense warrants this product against any defects in manufacturing for the warranty period of one year. If you require warranty service, be sure to have your proof of purchase and a barcode from the product packaging on hand when calling. Warranty service cannot be processed without proof of purchase.

Macsense cannot offer direct refunds for any product purchased in the retail channel. Proper refund must be done through the retail channel where the product was purchased. In no event shall Macsense's liability exceed the price paid for the product from direct, indirect, special, incidental, or consequential damages resulting from the use of the product, its accompanying software, or its documentation.

Macsense offers cross shipments, a faster process for processing and receiving your replacement. Macsense pays for UPS Ground only. All customers located outside of the United States and Canada shall be held responsible for shipping, custom duties, and handling charges. Please call Macsense Tech Support for more details.

To get tech support:

By knowledgebase: <http://www.macsense.com/knowledgebase/>

By Email: [support@macsense.com](mailto:support@macsense.com)

To register the product:

<http://www.macsense.com/registration/>

## Free Manuals Download Website

<http://myh66.com>

<http://usermanuals.us>

<http://www.somanuals.com>

<http://www.4manuals.cc>

<http://www.manual-lib.com>

<http://www.404manual.com>

<http://www.luxmanual.com>

<http://aubethermostatmanual.com>

Golf course search by state

<http://golfingnear.com>

Email search by domain

<http://emailbydomain.com>

Auto manuals search

<http://auto.somanuals.com>

TV manuals search

<http://tv.somanuals.com>