



Magellan[®] Maestro[™] 3250



User Manual

IMPORTANT SAFETY WARNINGS

The Magellan Maestro is a vehicle-navigation aid designed to assist you in arriving to your selected destinations. When using the Magellan Maestro, these safety rules must be followed to prevent accidents that can result in injury or death to yourself or others:

- California and Minnesota law prohibits mounting any item to your windshield. Please check with your state or local law enforcement for applicable regulations regarding windshield mounting. Go to www.magellanGPS.com for alternate mounting solutions. An adhesive disk is supplied with the Magellan Maestro for use as an alternate mounting solution to the dashboard.
- When driving, the need to view the display is minimal. Voice prompts will guide you to your destination. The driver should enter data or program the Magellan Maestro only when the vehicle is stopped. Only a vehicle passenger should enter data or program the Magellan Maestro while the vehicle is moving.
- It is your responsibility to comply with all traffic laws.
- Every attempt is made to ensure that the database is accurate. However, roadways, points of interest (POIs), and business and service locations may change over time. The database does not include, analyze, process, consider, or reflect any of the following: legal restrictions (such as vehicular type, weight, height, width, load and speed restrictions); road slope or grade; bridge height, width, weight, or other limits; population density; neighborhood quality or safety; availability or proximity of law enforcement, emergency rescue, medical, or other assistance; construction work zones or hazards; road or lane closures; road, traffic, or traffic facilities' safety or condition; weather conditions; pavement characteristics or conditions; special events; traffic congestion. It is your responsibility to disregard any unsafe, hazardous, or illegal route suggestions.
- Keep the Magellan Maestro safe from extreme temperature conditions. For example, do not leave it exposed to direct sunlight for an extended period of time.
- Take care when mounting the Magellan Maestro in your vehicle, whether using the windshield mount or other mount or accessories, that it does not obstruct the driver's view of the road, interfere with the operation of the vehicle's safety devices such as air bags, or present a hazard to occupants of the vehicle should the Magellan Maestro be dislodged while driving. You assume the risks associated with damage to your vehicle or vehicle occupants as the result of your choices in mounting the Magellan Maestro.
- Laws in some states prohibit wearing stereo headphones while operating a motor vehicle. Please contact your state's Department of Motor Vehicles for information.
- The battery in the Magellan Maestro is rechargeable and should not be removed. In the event it should need to be replaced, please contact Magellan Technical Support.

About Charging the Magellan Maestro

- An optional AC adapter is available as an accessory for your Magellan Maestro. Use of another type of AC adapter can result in malfunction and/or possible fire hazard due to battery over heating.
- Use only the car charger approved for / supplied with your Magellan Maestro. Use of another type of car charger will result in malfunction and/or damage to the receiver.
- For safety reasons, the battery in your Magellan Maestro will stop charging when the ambient temperature is less than 32°F (0°C) or more than 113°F (45°C).
- It will take approximately 4 hours of charging the Maestro through the cigarette lighter adapter or optional AC adapter to obtain a full battery charge.

About the Battery

- Do not attempt to replace the battery. Please contact Magellan Technical Support for issues related to the battery.
- Use the charger approved for your Magellan Maestro.

IMPORTANT SAFETY WARNINGS

Federal Communication Commission Interference Statement

This equipment has been tested and found to comply with the limits for a Class B digital device, pursuant to Part 15 of the FCC Rules. These limits are designed to provide reasonable protection against harmful interference in a residential installation. This equipment generates, uses and can radiate radio frequency energy and, if not installed and used in accordance with the instructions, may cause harmful interference to radio communications. However, there is no guarantee that interference will not occur in a particular installation. If this equipment does cause harmful interference to radio or television reception, which can be determined by turning the equipment off and on, the user is encouraged to try to correct the interference by one of the following measures:

- -Reorient or relocate the receiving antenna.
- -Increase the separation between the equipment and receiver.
- -Connect the equipment into an outlet on a circuit different from that to which the receiver is connected.
- -Consult the dealer or an experienced radio/TV technician for help.

This device complies with Part 15 of the FCC Rules. Operation is subject to the following two conditions: (1) This device may not cause harmful interference, and (2) this device must accept any interference received, including interference that may cause undesired operation.

FCC Caution: Any changes or modifications not expressly approved by the party responsible for compliance could void the user's authority to operate this equipment.

IMPORTANT NOTE:

FCC Radiation Exposure Statement:

This equipment complies with FCC radiation exposure limits set forth for an uncontrolled environment. End users must follow the specific operating instructions for satisfying RF exposure compliance.

This transmitter must not be co-located or operating in conjunction with any other antenna or transmitter.

In order to maintain compliance with FCC regulations, shielded cables must be used with this equipment. Operation with non-approved equipment or unshielded cables is likely to result in interference to radio and TV reception. The user is cautioned that changes and modifications made to the equipment without the approval of manufacturer could void the user's authority to operate this equipment.

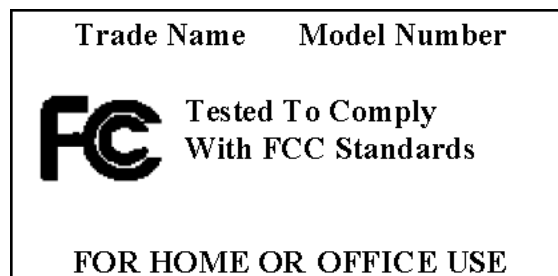

The Magellan Maestro must be installed and operated at a distance no closer than 8 inches (20 cm) from the user.

This Class B digital apparatus meets all requirements of the Canadian Interference-Causing Equipment Regulations.

Cet appareil numérique de la classe B respecte toutes les exigences du Règlement sur le matériel brouilleur du Canada.

IMPORTANT SAFETY WARNINGS

IC statement

Operation is subject to the following two conditions:

1. This device may not cause interference and
2. This device must accept any interference, including interference that may cause undesired operation of the device.

IMPORTANT NOTE:

IC Radiation Exposure Statement:

This equipment complies with IC radiation exposure limits set forth for an uncontrolled environment. End users must follow the specific operating instructions for satisfying RF exposure compliance.

This transmitter must not be co-located or operating in conjunction with any other antenna or transmitter.

The information provided in this document is subject to change without notice. Improvements and enhancements to the product may occur without any formal notification. Check the Magellan website (www.magellanGPS) for product updates and additional information.

© 2007 Magellan Navigation, Inc. All rights reserved. The Magellan Logo, Magellan, Maestro, TrueView, SmartDetour, and SmartVolume are trademarks of Magellan Navigation, Inc. No part of this user manual may be reproduced or transmitted in any form or by any means, electronic or mechanical, including photocopying and recording, for any purpose other than the purchaser's personal use, without the prior written permission of Magellan Navigation, Inc.

604-0012-001 A

Table of Contents

Table of Contents	1
Magellan Maestro 3250	1
Front View	2
Side Views	2
Back View	2
Installation Instructions	3
Selecting the Location	3
Cleaning the Area	3
Applying the Adhesive Disk	3
Attach the Cradle	3
Adjustable Mount	4
Secure the Mount to the Windshield or Adhesive Disk	4
Adjust the Mount for Optimum Viewing	4
Connecting Power and FM Antenna	4
Security	4
Region	5
Fundamentals	6
Powering on the Magellan Maestro	6
<i>Turning the Magellan Maestro On</i>	6
<i>Turning the Magellan Maestro Off</i>	6
<i>Selecting Auto-Power Shutdown Time</i>	6
Volume	6
<i>Changing the Volume from the Map Screen.</i>	6
<i>Changing the Volume from User Options</i>	7
Brightness	7
<i>Accessing the Brightness Control</i>	7
The Main Menu	7
<i>Accessing the Main Menu</i>	7
.Main Menu - Page 1	8
.Main Menu - Page 2	9
The Keypad	10
Keypad Overview	10
<i>Special Keys</i>	10
Selecting From List	10
Notes on Entering Data	11

Map Screen	12
<i>Accessing the Map Screen</i>	14
2D Mode	14
<i>Setting the Map Modes (2D or 3D)</i>	14
<i>Panning on the Map</i>	14
<i>Saving a Position While Panning</i>	14
<i>Routing to a Panned Position</i>	15
Current Location Screen	15
<i>Accessing the Current Location Screen</i>	15
<i>Saving Your Current Location to Your Address Book</i>	15
Maneuver List Screen	16
<i>Accessing the Maneuver List</i>	16
<i>Excluding a Maneuver</i>	16
GPS Status Screen	16
<i>Accessing the GPS Status Screen</i>	17
Zoom Levels	17
<i>Setting Zoom Levels</i>	17
Volume	17
<i>Changing the Volume from the Map Screen.</i>	17
 Home Address	 18
<i>Creating a Home Address</i>	18
<i>Creating a Route to the Home Address</i>	18
<i>Changing the Home Address</i>	18
<i>Accessing the Home Address from the Address Book</i>	19
 Enter Address	 20
Entering an Address	20
<i>Creating a Route to a New Address</i>	20
My Addresses	22
<i>Accessing the My Addresses Menu</i>	22
Previous Destinations	22
<i>Routing to a Previous Destination (Method 1)</i>	22
<i>Routing to a Previous Destination (Method 2)</i>	23
<i>Saving a Previous Destination to Your Address Book</i>	23
<i>Deleting a Previous Destination</i>	23
Address Book	24
<i>Accessing an Address in Your Address Book</i>	24
<i>Routing to an Address in Your Address Book</i>	24
<i>Editing an Address in Your Address Book</i>	24

<i>Deleting an Address in Your Address Book</i>	24
Favorites	25
<i>Accessing an Address from Favorites</i>	25
<i>Routing to an Address from Your Favorites List</i>	25
<i>Editing an Address from Your Favorites List</i>	25
<i>Deleting an Address from Your Favorites List</i>	25
Creating a New Entry	26
<i>Creating a New Entry to You Address Book by Selecting on the Map</i>	26
<i>Creating a New Entry to You Address Book by Entering an Address</i>	26
<i>Creating a New Entry to You Address Book from a POI</i>	26
<i>Creating a New Entry to You Address Book from by Intersections</i>	27
Intersection	27
<i>Creating a Route to Two Intersecting Streets</i>	28
Points of Interest (POI)	29
Categories and Subcategories	29
<i>Creating a Route to a POI by Category</i>	29
<i>Creating a Route to a POI by Name</i>	30
Enhanced POIs	30
<i>Loading a POI File</i>	30
<i>Selecting Categories for Display on the Map</i>	31
<i>Setting Alarms</i>	31
<i>Setting Alarm Parameters</i>	32
<i>Routing to an Enhanced POI</i>	32
<i>Saving an Enhanced POI to Your Address Book</i>	33
AAA TourBook®	33
Travelling on a Route	34
Map Screen	34
Split-Screen	34
Maneuver List	34
You Have Arrived	35
Types of Routes	35
Route Method	35
Special Routing Functions	36
<i>Routing to a POI Near an Approaching Freeway Exit</i>	36
<i>Cancelling a Route</i>	36
<i>Detouring off a Route</i>	36
<i>Changing the Route Method</i>	37

AAA TourBook®	38
Overview	38
AAA TourBook®	38
<i>Accessing the AAA TourBook®</i>	<i>38</i>
AAA TourBook® Information	39
<i>Getting AAA TourBook® Information</i>	<i>39</i>
<i>Routing To the Selected POI</i>	<i>39</i>
Show Your Card & Save®	40
<i>Getting Show Your Card & Save® Information</i>	<i>40</i>
<i>Routing to the Selected POI</i>	<i>40</i>
Approved Automotive Repairs	41
<i>Getting Approved Automotive Repair Information</i>	<i>41</i>
<i>Routing to the Selected Automotive Facility</i>	<i>41</i>
AAA Branch Offices	42
<i>Getting AAA Branch Office Information</i>	<i>42</i>
<i>Routing to the Selected AAA Branch Office</i>	<i>42</i>
Campgrounds	43
<i>Getting Campground Information</i>	<i>43</i>
<i>Routing To the Selected Campground</i>	<i>43</i>
AAA Roadside Assistance	44
Overview	44
The AAA Roadside Assistance Screen	44
<i>Accessing AAA Roadside Assistance</i>	<i>44</i>
<i>Entering Your AAA Membership Number</i>	<i>44</i>
Trip Planner	45
<i>Creating a Trip</i>	<i>45</i>
<i>Optimizing a Trip</i>	<i>46</i>
<i>Starting a Trip</i>	<i>47</i>
<i>Editing a Trip</i>	<i>47</i>
<i>Deleting a Trip</i>	<i>47</i>
<i>Renaming a Trip</i>	<i>48</i>
Exit POIs	49
<i>Routing to a POI Near an Approaching Freeway Exit</i>	<i>49</i>
Bluetooth	50
Introduction	50
<i>Accessing the Bluetooth Main Menu</i>	<i>50</i>
Pair Mode	50

<i>Pairing a Phone to the Magellan Maestro</i>	50
Establish Connection	51
<i>Establishing a Bluetooth Connection</i>	51
Place a call	51
<i>Placing a Call</i>	51
<i>Placing a Call Using the Address Book</i>	52
<i>Placing a Call Using Call History</i>	52
<i>Placing a Call Using Redial</i>	52
Failed Call	52
Call Connected	53
Incoming call	53
<i>Answering an Incoming Call</i>	53
Voice Control	54
Activating Voice Control	54
<i>Sample Nearest Restaurant</i>	54
Tips on Speaking Voice Commands	55
Traffic	56
<i>Activating the Free Subscription</i>	56
Glossary	57
Understanding How The TrafficKit Works	57
RDS-Traffic Operating Modes	57
Selecting Categories of Traffic Events	58
Re-routing Mode	58
Traveling with the Re-routing Mode On	59
Alert Only Mode	59
Traveling with the Alert Mode On	60
Traffic Alert Icon	61
Viewing Traffic Details	61
Viewing Traffic Details at Higher Zoom Levels	61
How To Disable the RDS	61
FAQs	62
User Options	63
<i>Selecting Map Region</i>	63
<i>Accessing System Settings</i>	63
<i>Checking Battery Life</i>	63
<i>Adjusting the Volume</i>	63
<i>Adjusting the Display Brightness</i>	64

<i>Setting Auto Power Off Time</i>	64
<i>Setting Time Zone</i>	64
<i>Selecting Units of Measure</i>	65
<i>Displaying Contact Us Information</i>	65
<i>Displaying Product Information</i>	65
<i>Performing Diagnostics</i>	66
<i>Accessing the Trip Computer</i>	66
<i>Selecting POIs to be Displayed on the Map</i>	67
<i>Deleting Addresses from the Address Book (Global)</i>	67
<i>Setting the Map in 3D or 2D Mode</i>	67
<i>Setting the Map Display to Heading Up or North Up</i>	68
<i>Setting Split Screen (TrueView™) Options</i>	68
<i>Setting Auto Night Map Display</i>	68
<i>Setting Detour Options</i>	69
<i>Using the Simulator</i>	69
<i>Setting Tone Options</i>	70
<i>Viewing Technical GPS Information</i>	70
<i>Setting the GPS Position</i>	70
<i>Backing Up and Restoring Data</i>	71
<i>Backing Up Data</i>	71
<i>Restoring Data</i>	71
<i>Viewing Map Information</i>	71

Magellan Maestro 3250

The Magellan Maestro 3250 is a vehicle navigation product that utilizes GPS signals from satellites to calculate your precise location and compute details about its travel. Knowing its position and movement, it can then overlay this information on detailed maps provided by NAVTEQ® to provide a visual representation of your location.

With the Magellan Maestro 3250 you can:

- Store your home address and quickly get routing details to your home.
- Create and save addresses in your address book that can be accessed at any time and get routing information to that address.
- Route to an address that you enter using the keypad and Magellan's QuickSpell feature for easy, errorless entry.
- Route to any point of interest (POI) that has been preloaded into your Magellan Maestro.
- Route to a POI that appears on the map while traveling simply by tapping on the POI icon.
- Route to an intersection by selecting the streets.
- Create a trip with multiple destinations using the trip planner. Handy for business people who need routing information to many destinations.
- View POIs that are ahead of you on the freeway. The exit POI function provides you with a list of gas stations, restaurants, hotels and auto repair shops located nearby exits you are approaching while traveling on a freeway.
- Customize your Magellan Maestro to meet your needs using the User Options menu.
- Use the AAA TourBook® to select a destination and get routing details to travel by. The AAA TourBook® also includes ratings, discount information for AAA members, hours of operation, information about the POI and other valuable facts.
- Access AAA Roadside Assistance for quick and easy access to information about your location to assist in getting AAA services to your location.
- Use the voice command and control to operate the Magellan Maestro hands-free.
- Connect a Bluetooth-enabled cell phone for hands-free phone calls.

The interface for the Magellan Maestro is easy and simple to follow once you understand the basics. You may never need to refer to this manual but if you do we have tried to present it in a form that you can access the function you are trying to complete and follow the steps provided.

The Magellan Maestro has a built-in battery so in most cases you will be able to follow these instructions while reading them on your computer screen without plugging the Maestro to AC power. You should note that while indoors you may not get any satellite signals so your location information would not be updated. However, the power of the SiRFstarIII™ chipset installed in the Magellan Maestro will get satellite signals in some very rough locations so you may notice the Magellan Maestro computing a position, even indoors.

This document is set up to be printed on 8.5" x 11" (letter) paper should you desire a printed version for your reference.

Front View

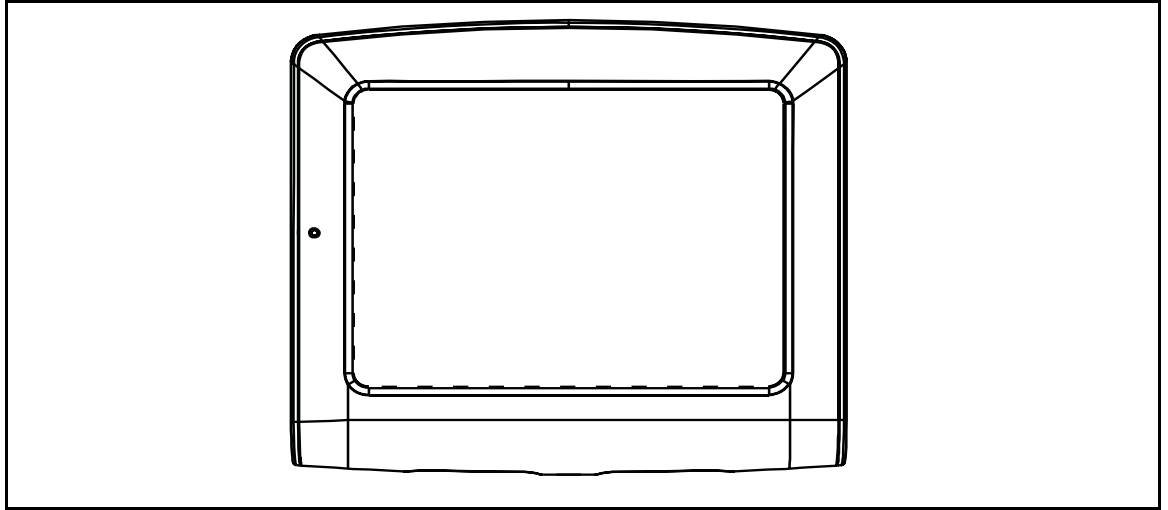

Side Views

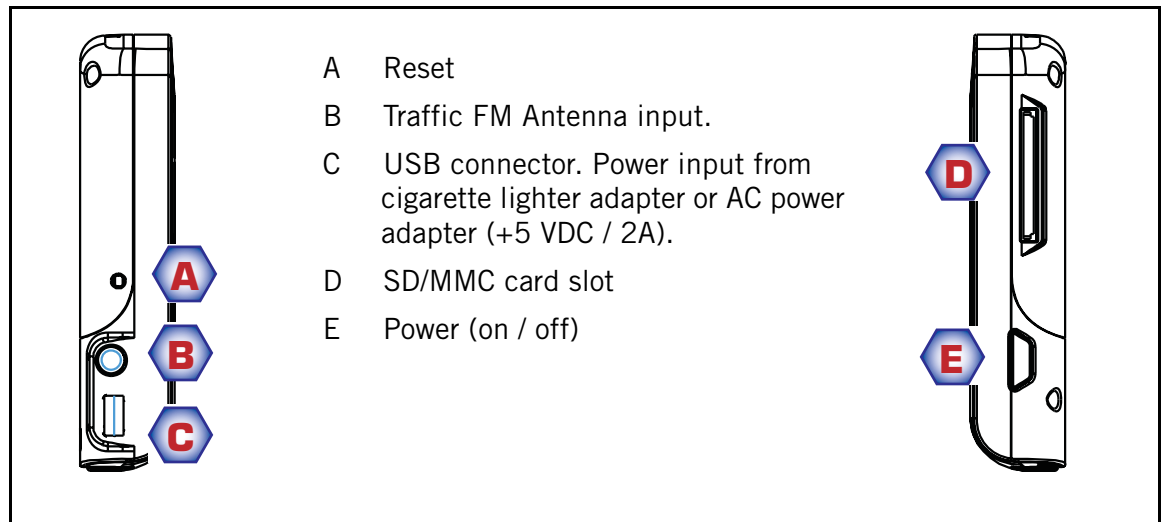

Back View

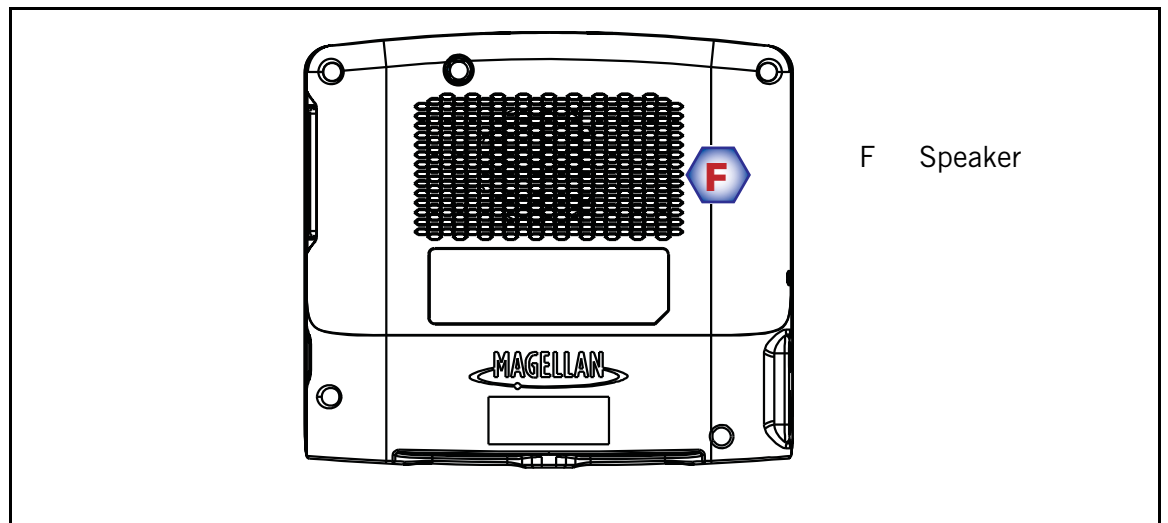

Installation Instructions

Installation of the Magellan Maestro is simple and easy. The hardest part will be picking the best location.

Selecting the Location

A few tips on selecting the proper location.

- Mount the Magellan Maestro in a place where it can be easily seen and will not interfere with your view of the road.
- The Magellan Maestro should be mounted in such a way that the antenna, (located in the top of the receiver), has an unobstructed view of the sky through the windshield.
- Select whether it will be mounted using the adjustable mount to the windshield or the supplied adhesive disk. Be sure to check your local and regional laws before mounting to the windshield. Some states, like California and Minnesota, have laws restricting the mounting of any device on the windshield.
- If planning to use the adhesive disk, a smooth surface on the dash board will need to be selected. Do not attach the adhesive disk to the windshield.
- Make sure that the Magellan Maestro or any cabling will not be disturbed in the event that the airbags are deployed.

Cleaning the Area

Use the alcohol pad that came with the Magellan Maestro to clean the area on the windshield or dash that has been selected for mounting the Magellan Maestro. Let the area dry completely.

Applying the Adhesive Disk

(Skip if mounting directly to the windshield.) Remove the protective tape from the back of the adhesive disk. Apply the disk with the adhesive side towards the dash. Maintain pressure on the disk for 5 minutes to allow it to set in place. Allow the disk 24 hours to cure before continuing.

Attach the Cradle

Align the tabs on the cradle to the indents on the bottom of the Magellan Maestro. Swivel the cradle up so that it is flush against the back of the receiver and snaps into place.



Please note that the mounting bracket supplied with the Magellan Maestro may be different than the one shown in this document.

Adjustable Mount

Line up the two tabs on the adjustable mount with the holes on the back of the Magellan Maestro. Once the adjustable mount is flush with the Magellan Maestro, push the receiver down until it locks in place with the adjustable mount.

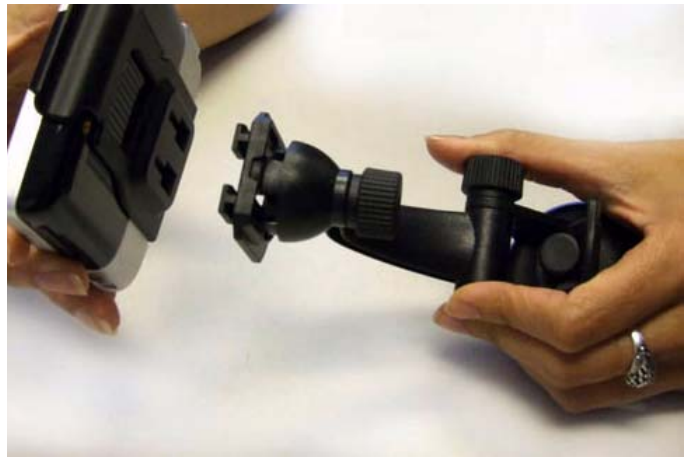

Secure the Mount to the Windshield or Adhesive Disk

Make sure that the lever at the base of the adjustable mount is in the up position. Place the base of the mount firmly over the area of the windshield to be used or the adhesive disk. Push the lever at the base of the mount all the way down until it snaps in place. Carefully let go of the assembly, making sure that it is securely mounted.

Adjust the Mount for Optimum Viewing

Loosen the adjustment locking knobs and position the Magellan Maestro for optimum viewing. Once set, tighten the locking knobs. (Never attempt to adjust the mount while driving.)

Connecting Power and FM Antenna

Plug the end of the cigarette lighter adapter into a 12 VDC cigarette lighter receptacle in the vehicle. Connect the other end to the Magellan Maestro's USB connector as shown. If there is power at the receptacle, the Magellan Maestro will power on. (Note: some vehicles apply power to the cigarette lighter receptacle only when the ignition is on.)

Connect the FM Traffic Antenna connector (from the cigarette lighter adapter into the FM antenna receptacle.



Security

It is recommended that the Magellan Maestro is not left in plain view while unattended for reasons of theft.

Region

By default, the Magellan Maestro has the region setting for the lower 48 United States. If you are travelling in Alaska, Hawaii, Canada or Puerto Rico you must change the region in User Options.

- 1 From the Main Menu, tap on the right arrow to access the second page of the Main Menu.
- 2 Tap on **User Options**.
- 3 Tap on **Region**.
- 4 Tap on the map region desired.

Powering on the Magellan Maestro

The On/Off button is located on the bottom right side of the Magellan Maestro as shown in the Overview chapter.

Turning the Magellan Maestro On

1. Press and hold the On/Off button for 1-2 seconds.
2. Read the Warnings and tap **OK**.

Turning the Magellan Maestro Off

1. Press and hold the On/Off button for 1-2 seconds.

Selecting Auto-Power Shutdown Time



The Magellan Maestro can be set up to shut down automatically using the time durations you can select. The receiver will turn off after the selected duration has passed when; A) the position hasn't changed and B) the touchscreen hasn't been pressed.

1. Access the *Main Menu*.
2. Tap the **Next** arrow to access the *Main Menu Page 2*.
3. Tap **User Options**.
4. Tap **System Settings**.
5. Tap **Power**.
6. Select Auto-Power Off time; Never, 10 Minutes, 20 Minutes or 30 Minutes.
7. Tap **Save**.
8. Tap the **Back** arrow to return to the *Main Menu*.

Volume

There are two ways to access the volume controls; one is tapping the speaker icon on the Map screen and the other is through User Options.

Changing the Volume from the Map Screen.

1. Tap the speaker icon  .
2. Tap on the Mute button to mute the volume or tap inside the volume adjust bar below the Mute button to change the volume levels.
3. Tap  .

If you have the volume muted the speaker icon is displayed with a line through it indicating it is muted. To unmute, tap the speaker icon again and the Maestro will automatically unmute. To make any other adjustments to the volume, press the speaker icon again.

Changing the Volume from User Options

1. Access the *Main Menu*.
2. Tap the **Next** arrow to access the *Main Menu Page 2*.
3. Tap **User Options**.
4. Tap **System Settings**.
5. Tap **Volume**.
6. Tap on the Mute button to mute the volume or tap inside the volume adjust bar below the Mute button to change the volume levels.
7. Tap .

Brightness

Accessing the Brightness Control

1. Access the *Main Menu*.
2. Tap the **Next** arrow to access the *Main Menu Page 2*.
3. Tap **User Options**.
4. Tap **System Settings**.
5. Tap **Brightness**.
6. Tap inside the brightness adjust bar to set the desired brightness.
7. Tap .

On the *Brightness* screen there is a checkbox for “On-battery dimming (75%)” When checked, the Magellan Maestro will dim to 75% of the brightness when operating exclusively on battery power. This prolongs the battery life between charges. It can be turned off by tapping on the checkbox.

The Main Menu

The *Main Menu* screen is the center for all the available functions for the Magellan Maestro. The *Main Menu* consists of two pages with large, easy to access icons.

Accessing the Main Menu

From the *Map* screen tap the **Menu** button. 

From the other screens, tap the **Back** button. 

.Main Menu - Page 1

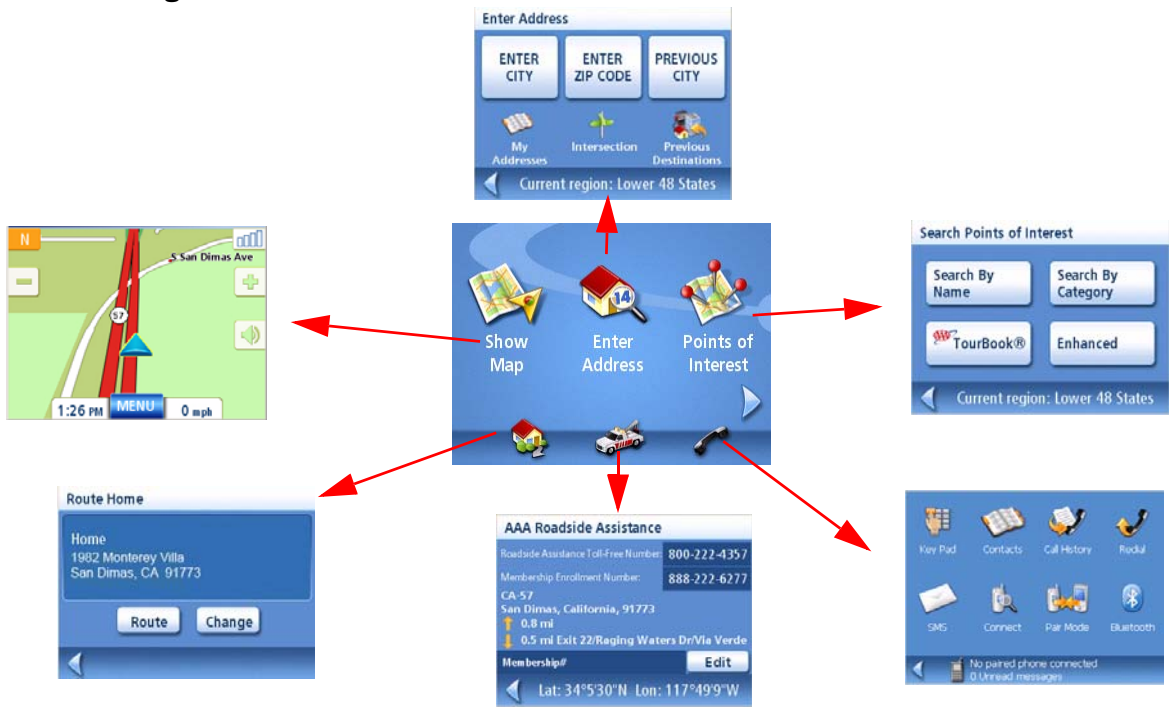

Show Map: Displays the map with your current position (if computing a position from the GPS signals) indicated by the blue triangle. See the Map Screen chapter for details.

Enter Address: Displays *Enter Address* menu. Addresses can be entered by first entering the city, zip code, or by selecting a city from a list of cities you have already used as destinations. Also provides access to your address book (my addresses) or to create a route to an intersection. See the chapter on Routing to an Address for details.

Points of Interest: Displays the *Search Points of Interest* menu. Search for POIs by entering the name or by selecting from a list of available categories.

Home: If you have created a Home address, press the Home button for quick access to your home. If a Home address has not been created, a prompt is displayed to do so. See the Home Button chapter for more information.

AAA Roadside Assistance: Displays the *AAA Roadside Assistance* screen. For more information on the *AAA Roadside Assistance* screen, see the chapter on AAA Roadside Assistance.

BlueTooth Menu: Displays the BlueTooth menu used to pair the Maestro with a BlueTooth-enabled phone as well as initiate phone calls and user options.

.Main Menu - Page 2

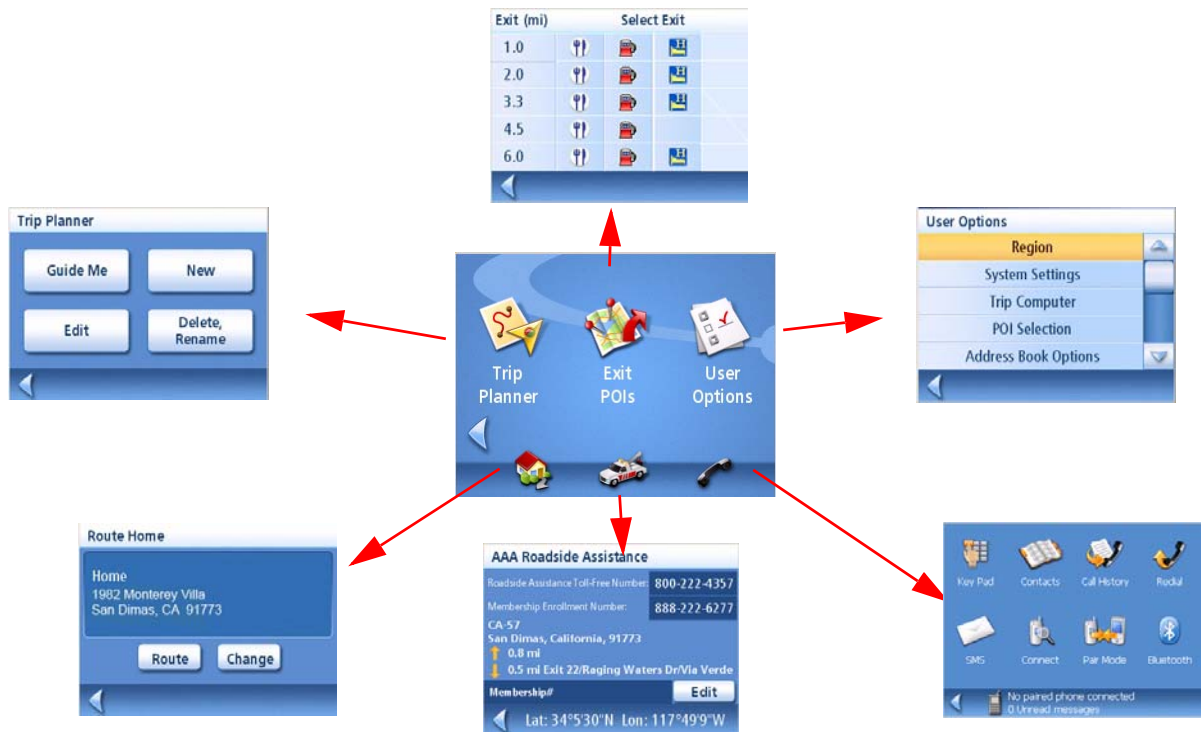

Trip Planner: Opens the Trip Planner menu where you can create, edit, delete, rename or activate a trip.

Exit POI's: (Accessible only while on a freeway.) Provides a listing of restaurants, gas stations, or hotels near approaching freeway exits. You can select one of the POIs presented and create a route to it.

User Options: Accesses the User Options menu. This menu can be used to access functions used to customize the Magellan Maestro to your personal needs.

Home: If you have created a Home address, press the Home button for quick access for routing to your home. If a Home address has not been created, a prompt is displayed to do so. See the Home Button chapter for more information.

AAA Roadside Assistance: Displays the AAA Roadside Assistance screen. For more information on the AAA Roadside Assistance screen, see the chapter on AAA Roadside Assistance.

BlueTooth Menu: Displays the BlueTooth menu used to pair the Maestro with a BlueTooth-enabled phone as well as initiate phone calls and user options.

The Keypad

Understanding the keypad while entering an address is an important part of using your Magellan Maestro. The keypad is the most common means of entering data into the Magellan Maestro.

Keypad Overview

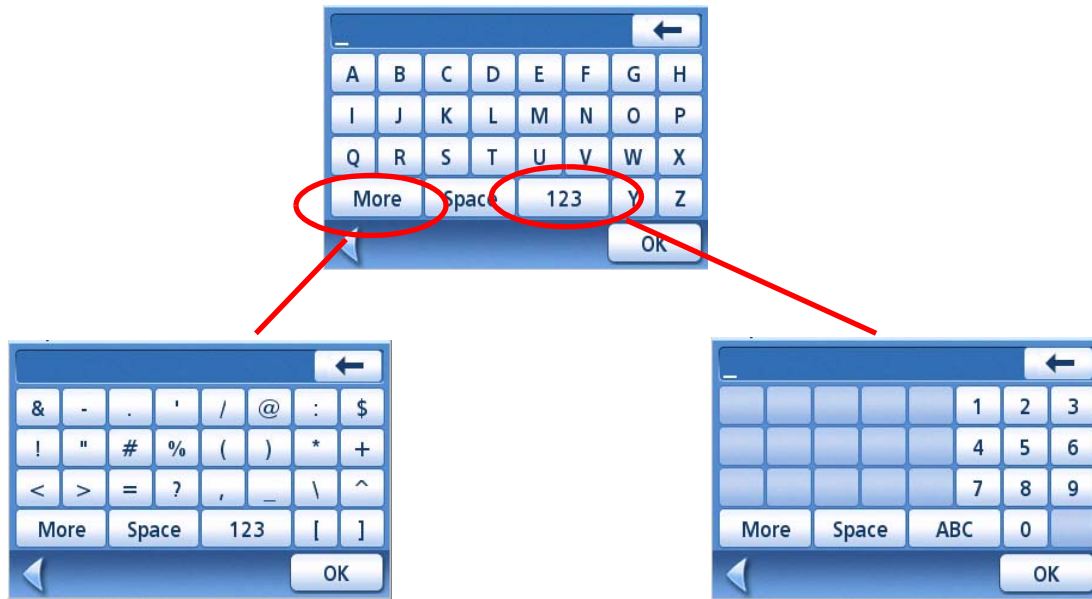

Special Keys

	Alphabetic Keypad		Numeric Keypad
	Symbols Keypad		Spacebar
	Backspace		
	Accept		Cancel

Selecting From List

After tapping "OK" to accept your input you may get a list of items found in the database. The sample here shows the result of tapping "OK" after entering "LOS A". Use the scroll bar to move up and down the list and tap on the desired item in the list to continue.

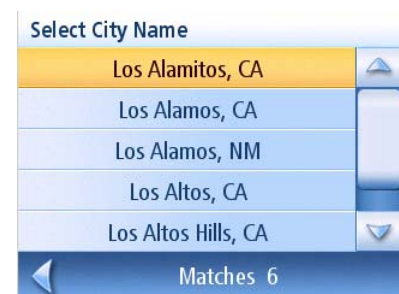

Notes on Entering Data

If you are having trouble getting the results you expected here are a few useful tips.

- Make sure that you have spelled the name correctly. If you are unsure of the spelling, just enter a few characters and tap “OK”. A long list of names will be displayed but you can step through the list and probably be able to find the correct spelling.
- Check for apostrophes and hyphens. If you are not seeing the POI you are looking for in the POI list, check to see if the name has an apostrophe or hyphen.
- When entering a street name you can use the street prefix (N. E. W. S. etc.) to narrow the search. For example to find N. Main St. you could enter “N. Main” or “N Main”.
- The more characters you enter, the smaller the list of possible options from which to choose.

Map Screen

The most commonly used screen will be the *Map* screen. Whether on a route or just travelling around town, chances are the *Map* screen will be displayed. There are two unique modes that the *Map* screen can be displayed in; normal and routing.

In normal mode, your position is shown on the map along with the time and your speed. As you travel, your position will be updated, giving you a clear view of your position and surrounding streets.



Map Screen - Normal Mode

- A** Street name currently on.
- B** Direction indicator. Tap to view the Current Location screen where you can save your position into your Address Book.
- C** Zoom out
- D** POI icon. Sample shown here is for a gas station. Tap on the POI icon to create a route to that POI. Note: If there are multiple POIs in the same area, a list of those POIs will be displayed. Tap on the name in the list to access the routing function.
- E** Current position icon
- F** Time of day
- G** Main Menu button. Tap to display the *Main Menu*.
- H** Current speed of travel
- I** Volume control. Tap to display the *Volume Setting* screen where the loudness can be adjusted or muted. (If the volume has been muted, tapping this button unmutes the volume without displaying the Volume Setting screen.)
- J** Zoom in
- K** Satellite Status. All four bars in green is optimal. Tap to display the *GPS Status* screen.

In routing mode additional information is displayed providing detailed information about the route you've selected.



Map Screen - Routing Mode

- A** Street name currently on.
- B** Direction indicator. Tap to view the Current Location screen where you can save your position into your Address Book.
- C** Zoom out
- D** POI icon. Sample shown here is for a gas station. Tap on the POI icon to create a route to that POI. Note: If there are multiple POIs in the same area, a list of those POIs will be displayed. Tap on the name in the list to access the routing function.
- E** Current position icon
- F** Next maneuver icon. Tap on the icon to display the *Maneuver List* screen.
- G** Distance to next maneuver. Tap to repeat the last voice command.
- H** Main Menu button. Tap to go to the Main Menu screen. Note that the Main Menu screen is different when there is an active route. See the chapter on Routing for details.
- I** Tap to toggle between distance remaining to reach destination, approximate time remaining until the destination is reached and the approximate the time of day to arrive at the destination.
- J** Street name for the next maneuver
- K** Graphical representation of the route
- L** Volume control. Tap to display the *Volume Setting* screen where the loudness can be adjusted or muted. (If the volume has been muted, tapping this button unmutes the volume without displaying the Volume Setting screen.)
- M** Zoom in
- N** Satellite Status. All four bars in green is optimal. Tap to display the *GPS Status* screen.

Accessing the Map Screen

1. On the Main Menu, tap **Show Map**.



2D Mode

The map is normally displayed in 3D mode but you can set the map to 2D mode if so desired. Choose the mode that is best suited for you.

In 2D mode, you can pan across the map looking for a location to route to or save in your address book.

Setting the Map Modes (2D or 3D)

1. From the *Map* screen, tap **MENU**.
2. Tap the **Next arrow** to access page 2 of the *Main Menu*.
3. Tap **User Options**.
4. Tap **Map Options**.
5. Tap **3D Map** or **2D Map**.
6. Tap **Save**.



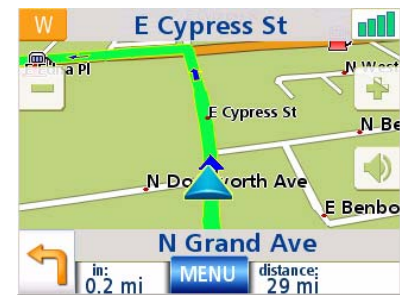

Map Screen in 2D Mode









Map Screen in 3D Mode

Panning on the Map



1. While viewing the *Map* screen in 2D mode, slide your finger or stylus across the map.
2. The location icon changes to . (The circle is the crosshairs for a position and the red arrow points to your current location.)
3. To exit panning, tap  and the map is returned to your current position.

Saving a Position While Panning

1. Pan the map until the icon crosshairs are over the location you want to save to your address book. (Must be a position that does not have a POI icon displayed.)
2. Tap in the center of the icon circle. (If nothing happens then you are not zoomed in enough. Tap the zoom in icon and try again.)
3. On the *Route To This Address?* screen, tap .
4. Edit Information:
Tap  on the Edit Name line to create a name for this location.
Tap on any of the three (work, home, mobile) phone buttons to enter a phone number.
Tap  on the Edit Information line to add additional information. (Up to 35 characters can be entered.)
5. If you want to tag this location as one of your favorites, tap on the "Favorite" check box.

- When the details for this address are acceptable, tap .
- If you want to now route to this address tap  or if you are done tap .
- Tap  to exit panning and return the icon to your current position.

Routing to a Panned Position

- Pan the map until the icon crosshairs are over the location you want to route to.
- Tap in the center of the icon circle. (If nothing happens then you are not zoomed in enough. Tap the zoom in icon and try again.)
- On the *Route To This Address?* screen, tap ,
- Select the routing method desired and tap the Calculate Route  button.

Current Location Screen

This screen is accessed from the *Map* screen whether you are on a route or just normal driving.





The *Current Location* screen displays approximate address information, the next and previous cross streets, as well as your latitude/longitude. To the right is a compass point in your direction of travel, calculated elevation, and speed. The bottom bar displays the current time and date.



Accessing the Current Location Screen

- From the *Map* screen, tap the direction icon in the upper left corner.

Saving Your Current Location to Your Address Book

- Access the *Current Location* screen.
- Tap .
- Edit Information:
Tap  on the Edit Name line to create a name for this location.
Tap on any of the three (work, home, mobile) phone buttons to enter a phone number.
Tap  on the Edit Information line to add additional information. (Up to 35 characters can be entered.)
- If you want to tag this location as one of your favorites, tap on the "Favorite" check box.
- When the details for this address are acceptable, tap .

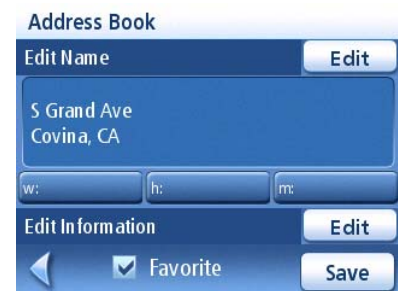

Saving Current Location

Maneuver List Screen

This screen is accessed from the Map screen and only when routing. (Note: The Maneuver List screen is not available until you begin moving on the route.)

Each line in the maneuver list provides details about the maneuver in the order that they are to be made, with the next maneuver at the top.

The bottom bar of the Maneuver List indicates the distance and time to the next maneuver as well as the total distance computed for the route.

The Maneuver List can be modified if you want to exclude one of the maneuvers should you want to avoid travelling one of the streets listed. Instructions to exclude one of the maneuvers is described in this chapter.

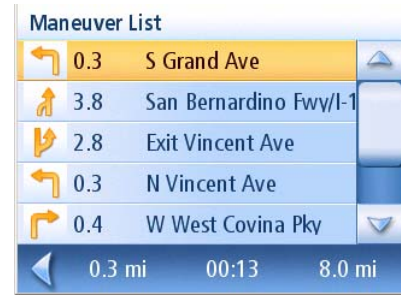

Maneuver List

The maneuver highlighted indicates that you will be instructed to make a left turn in 0.3 miles on S. Grand Ave.

Accessing the Maneuver List

1. Tap the maneuver icon in the lower left corner of the Map screen. This icon is displayed only while on an active route.

Excluding a Maneuver

This is used to modify the route to possibly avoid routing on a particular street.

1. Access the Maneuver List.
2. Tap on the item in the list with the street you want to try and avoid.
3. Confirm the exclusion by tapping on . (Tap the back arrow to cancel.)
4. The Magellan Maestro recalculates the route and displays the Maneuver List with the newly computed maneuvers.

GPS Status Screen

1. The *GPS Status* screen is also accessed from the *Map* screen and displays the status of the GPS satellites in a graphical format. (More technical information on the GPS status can be found in under the User Options menu: Main Menu Page 2 > User Options > GPS Options > GPS Status.)

Green bars indicate that the Magellan Maestro is using these satellites to compute the position; orange bars indicate that the Magellan Maestro is trying to lock on to the satellite signal; and no bar shown indicates a satellite that is not being tracked. The longer the bars, the better the signal.

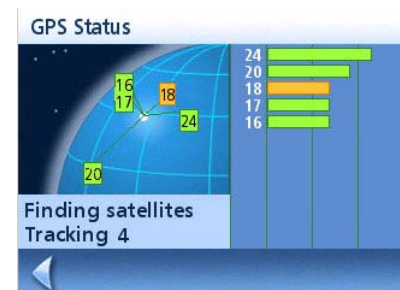

GPS Status Screen

Accessing the GPS Status Screen



1. From the *Map* screen, tap the GPS Signal Strength icon in the upper right corner.

Tap on the back arrow to return to the *Map* screen.

Zoom Levels

There are 23 zoom levels in the Magellan Maestro, ranging from 100 feet to 1200 miles. Select the zoom level that best suits your needs.



Setting Zoom Levels

1. While viewing the *Map* screen, tap on the  (zoom in) or  (zoom out).

Volume

The volume can be adjusted or muted from the *Map* screen. (The volume can also be adjusted from User Options > System Settings > Volume.)

Changing the Volume from the Map Screen.

1. Tap the speaker icon .
2. Tap on the Mute button to mute the volume or tap inside the volume adjust bar below the Mute button to change the volume levels.
3. Tap .

If you have the volume muted the speaker icon is displayed with a line through it indicating it is muted. To unmute, tap the speaker icon again.

Home Address

Your home address can be entered and saved in the Magellan Maestro for quick and easy access when you need to create a route home.

Creating a Home Address

These instructions only apply if you have never entered a home address or if it has been deleted.

1. Tap the Home Address icon  on the *Main Menu* screen.
2. Confirm “Do you want to enter your HOME address?” Tap **Yes**.
3. Follow the prompts to enter the address to be used as your HOME address.
4. When the Address screen is displayed, edit the information and top **SAVE** to continue.
5. The HOME address is saved in your address book and you are returned to the *Main Menu* screen.

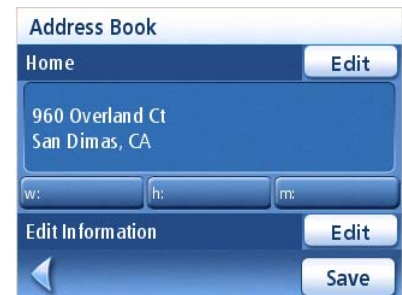

Creating a Route to the Home Address

1. Tap the Home Address icon  on the *Main Menu* screen.
2. Tap **Route**.
3. Select the Route Method desired and tap the orange **Calculate Route** button.



Changing the Home Address

1. Tap the Home Address icon  on the *Main Menu* screen.
2. Tap **Change**.
3. Confirm “Do you want to replace the HOME address with a new address?” Tap **Yes**.
4. Follow the prompts to enter the address to be used as your new HOME address.

- When the Address screen is displayed, edit the information and tap **SAVE** to continue.
- The new HOME address is saved in your address book and you are returned to the *Main Menu* screen.

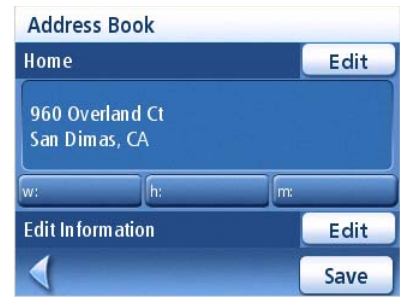

Accessing the Home Address from the Address Book

- From the *Main Menu*, tap the **Enter Address** icon.
- Tap the **My Addresses** icon.
- Tap **Address Book**.
- Tap **List All**.
- The list of addresses in your address book are displayed with the home icon on the line of your HOME address.
- Tap on the home item in the list to create a route to, edit or delete the HOME address.

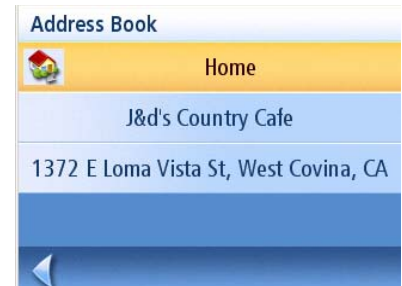

Enter Address

The Enter Address function is used to create a route from a newly entered address, an address in your address book or to an intersection of two streets.

Entering an Address

While creating an address the first step is to indicate what city the address is in. This can be done by inputting the name of the city, entering the zip code for the city or by selecting a city that has been previously used.

Creating a Route to a New Address

1. From the *Main Menu*, tap the **Enter Address** icon.



2. Select the method to enter the city: **Enter City**, **Enter Zip Code**, or **Previous City**.

Enter City:

Use the keypad to enter the first few characters of the city name. Tap **OK** to display the list of cities found.

Tap on the desired city in the list.

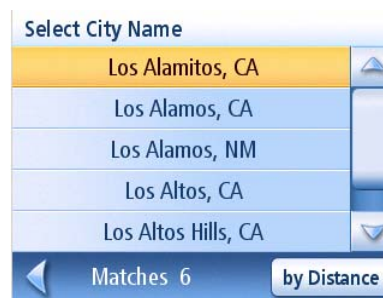

List of Cities

Enter Zip Code:

Use the keypad the zip code for the city. Tap **OK** when the zip code is complete.

The button in the lower right corner is used to select the sorting order of the list, by zip code or alphabetically.

Tap on the desired city in the list.

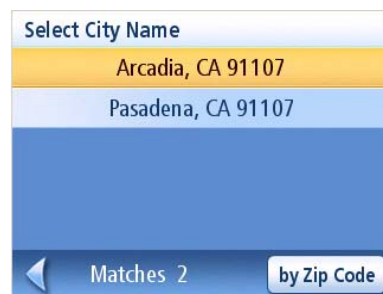

Cities with the Zip Code Entered

Previous City:

Tap on the desired city in the list.

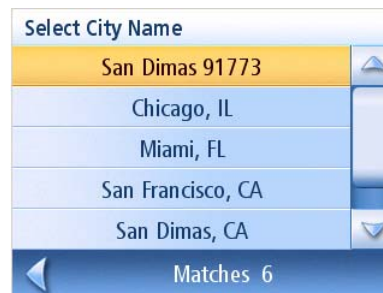

List of Cities Previously Used

3. With the city selected, the keypad will be displayed asking for the street name. Use the keypad with QuickSpell to enter the street name. Enter the first few characters of the street name and tap OK or continue entering characters until the list of streets is displayed. You can use street prefixes (N, E, W, S, etc.) if desired.

Samples the city Pasadena, California:

Entering "ALLE" results in:

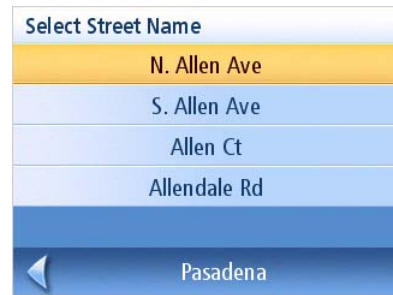

Entering "N A" or "N. A" results in:

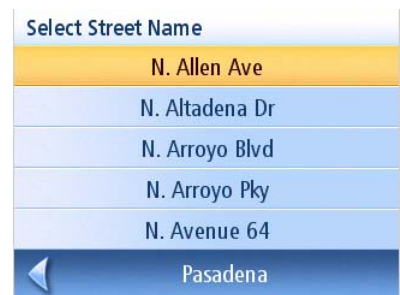

However, typing in "NOR" can give some unexpected results if you are trying to type in the word "NORTH ALLEN".:

Entering "NOR"



To resolve this, use the back arrow from the street list and continue typing in the word NORTH. Now all streets beginning with "North" as well as streets with the north prefix are displayed.

Entering "NORTH"

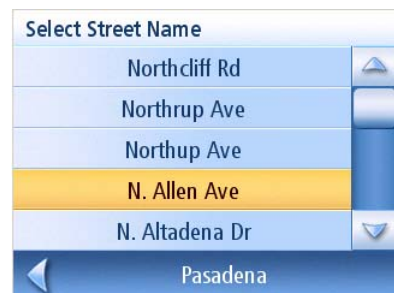

- Use the scroll bars to the right if necessary to view the name of the street desired. Tap on the street name to continue.
- Use the keypad to enter the street number for the address. Note in the top left corner is the range of acceptable street numbers.
- Tap **Done** when the address is complete.
- Select the desired route method and tap the orange **Calculate Route** button to begin routing.

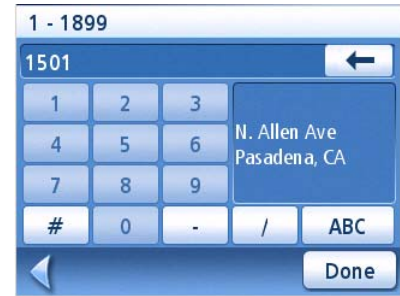

My Addresses

My Addresses is where you store addresses that you want to keep as future destinations as well as access addresses that you have gone to recently that may not be in your address book. The address book can hold up to 250 addresses.

Accessing the My Addresses Menu

- From the *Main Menu*, tap the **Enter Address** icon.



- Tap on the **my addresses** icon.



- The *My Addresses Menu* is displayed.



Previous Destinations

Routing to a Previous Destination (Method 1)

- From the *Main Menu*, tap the **Enter Address** icon.





- Tap on the **Previous Destinations** icon.





- Select the destination from the list of previous destinations.
- Select the Route Method and tap the orange **Calculate Route** button.



Routing to a Previous Destination (Method 2)

1. From the *Main Menu*, tap the **Enter Address** icon. 
2. Tap on the **my addresses** icon. 
3. Tap on **Previous Destinations**.
4. Select the destination from the list of previous destinations.
5. Tap on **Route**.
6. Select the Route Method and tap the orange **Calculate Route** button.

Saving a Previous Destination to Your Address Book

1. From the *Main Menu*, tap the **Enter Address** icon. 
2. Tap on the **my addresses** icon. 
3. Tap on **Previous Destinations**.
4. Select the destination from the list of previous destinations.
5. Tap on **Edit**.
6. Apply any edits you want to make to this destination before saving.
7. Check Favorite if you want this addresses store in your address book as a Favorite.
8. Tap **Save** to store the address.
9. The *Previous Destination* screen is displayed. Tap **Route** to route to this destination or the **Back** arrow to return to the list of previous destinations.



Deleting a Previous Destination

1. From the *Main Menu*, tap the **Enter Address** icon. 
2. Tap on the **my addresses** icon. 
3. Tap on **Previous Destinations**.
4. Select the destination from the list of previous destinations.
5. Tap on **Delete**.
6. Confirm Deletion. Tap **Yes**.
7. The *Enter Address Menu* will be displayed.

It is possible to delete all of the destinations in the Previous Destination List by accessing User Options > Address Book Options > Clear Previous.

Address Book

Accessing an Address in Your Address Book

1. From the *Main Menu*, tap the **Enter Address** icon. 
2. Tap on the **my addresses** icon. 
3. Tap on **Address Book**
4. Tap List All to view the entire contents of your address book or tap on Search Address Book to search for entries by searching on the name.
5. From the list of addresses found, tap on the address record desired.

Routing to an Address in Your Address Book

1. Access the address record from your address book as described in *Accessing an Address in Your Address Book*.
2. Tap on **Route**.
3. Select the Route Method and tap on the orange **Calculate Route** button to continue.

Editing an Address in Your Address Book

1. Access the address record from your address book as described in *Accessing an Address in Your Address Book*.
2. Tap on **Edit**.
3. Use the *Edit Address Book* screen to modify the name, information or phone numbers. The street address cannot be changed.
4. Tap **Save** when done.



Deleting an Address in Your Address Book.

1. Access the address record from your address book as described in *Accessing an Address in Your Address Book*.
2. Tap on **Delete**.
3. Confirm deletion. Tap **Yes**.
4. You are returned to the list of addresses in your address book. If the list is now empty, you are returned to the previous screen.

Favorites

Favorite addresses operate the same as other addresses in your address book. Addresses in your address book can be marked as favorites to speed up the search for commonly used addresses.

Accessing an Address from Favorites

1. From the *Main Menu*, tap the **Enter Address** icon. 
2. Tap on the **my addresses** icon. 
3. Tap on **Favorites**
4. From the list of addresses found, tap on the address record desired.

Routing to an Address from Your Favorites List

1. Access the address record from your Favorites as described in *Accessing an Address from Favorites*.
2. Tap on **Route**.
3. Select the Route Method and tap on the orange **Calculate Route** button to continue.

Editing an Address from Your Favorites List

1. Access the address record from your Favorites as described in *Accessing an Address from Favorites*.
2. Tap on **Edit**.
3. Use the *Edit Address Book* screen to modify the name, information or phone numbers. The street address cannot be changed.
4. Tap **Save** when done.



Deleting an Address from Your Favorites List

1. Access the address record from your Favorites as described in *Accessing an Address from Favorites*.
2. Tap on **Delete**.
3. Confirm deletion. Tap **Yes**.



Creating a New Entry

This is used to create a new address and save it in your address book. You can create an entry by selecting it on the map, entering the address, selecting an address from the list of POIs or choosing a street intersection.



Creating a New Entry to Your Address Book by Selecting on the Map

1. From the *Main Menu*, tap the **Enter Address** icon. 
2. Tap on the **my addresses** icon. 
3. Tap on **Create New Entry**.
4. Tap on **Select on Map**.
5. The Map screen is displayed in 2D mode. Use your finger or stylus to pan around the map. When the crosshair icon is over the location you want to add to your address book, tap in the center of the crosshairs. (Note: you may need to zoom into a lower zoom level if the edit Address Book screen is not displayed.)
6. Edit the name, information and phone numbers for the location you selected on the map. Tap the Favorites checkbox if you want this saved as a favorite address.
7. Tap **Save**.

Creating a New Entry to Your Address Book by Entering an Address

1. From the *Main Menu*, tap the **Enter Address** icon. 
2. Tap on the **my addresses** icon. 
3. Tap on **Create New Entry**.
4. Tap on **Enter Address**.
5. Enter the address following the prompts. Detail on address entry can be found in this chapter in the Entering an Address section,
6. Edit the name, information and phone numbers for the location you selected on the map. Tap the Favorites checkbox if you want this saved as a favorite address.
7. Tap **Save**.

Creating a New Entry to Your Address Book from a POI

1. From the *Main Menu*, tap the **Enter Address** icon. 
2. Tap on the **my addresses** icon. 



3. Tap on **Create New Entry**.
4. Tap on **POIs**.
5. Select the category from the list of POI categories.
6. If a subcategory list is displayed, select ALL Subcategories or one from the list.
7. Select search criteria:

Near Current Position Displays POIs in the category selected nearest to your current position. If no POIs are within a 50 mile radius, the search is empty and an alert displayed.

Near What City?: Enter a city name using the keypad (no QuickSpell) and select the city center desired from the resulting list. This will display POIs in the category selected nearest to the city center selected.(



Near Address: Enter an address using the standard address entry function. This will display POIs in the category selected nearest to the address entered.
8. Tap on the POI name desired from the list. Use the **Prev** and **Next** buttons to scroll up and down the list.(
9. Edit the name, information and phone numbers for the POI selected. Tap the Favorites checkbox if you want this saved as a favorite address.
10. Tap **Save**.

Creating a New Entry to Your Address Book from by Intersections

1. From the *Main Menu*, tap the **Enter Address** icon. 
2. Tap on the **my addresses** icon. 
3. Tap on **Create New Entry**.
4. Tap on **Intersection**.
5. Select the city that the intersection is located in by entering the city name, entering the zip code or selecting from the previous cities list.
6. Search for the first street by spelling out the street name following the guidelines presented in *Entering an Address*. Tap on the street from the list of streets.
7. Search for the second street the same as in step 6. However, the Magellan Maestro uses QuickSpell to allow you to select only streets that intersect with the street selected in step 6. Tap on the intersecting street from the list of streets.
8. Edit the name, information and phone numbers for the POI selected. Tap the Favorites checkbox if you want this saved as a favorite address.
9. Tap **Save**.

Intersection

Creating a Route to Two Intersecting Streets

1. From the *Main Menu*, tap the **Enter Address** icon. 
2. Tap on the **intersection** icon. 
3. Select the city that the intersection is located in by entering the city name, entering the zip code or selecting from the previous cities list.
4. Search for the first street by spelling out the street name following the guidelines presented in *Entering an Address*. Tap on the street from the list of streets.
5. Search for the second street the same as in step 6. However, the Magellan Maestro uses QuickSpell to allow you to select only streets that intersect with the street selected in step 6. Tap on the intersecting street from the list of streets.
6. Select the Route Method and tap on the orange **Calculate Route** button.

Points of Interest (POI)

The Magellan Maestro has POIs preloaded that can be used as a destination for a route. Selecting a restaurant or finding an ATM nearby is at your fingertips.

Categories and Subcategories

POIs are categorized into unique categories from gas stations to wineries. Most, but not all categories are further organized into subcategories. Restaurants have, for example, 16 subcategories that provide a way to search for restaurants serving Chinese food, or fast food, and even Swiss food.

Creating a Route to a POI by Category

1. From the *Main Menu*, tap the **Points of Interest** icon.
2. Select **Search by Category**.
3. Use the scroll bars to view the categories and tap on the desired category name.

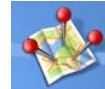

Category List

4. If a subcategory is displayed, use the the scroll bars to view the subcategories and tap on the desired subcategory name. Select ALL SUBCATEGORIES if you are unsure what subcategory best suits your needs.
5. Select the search criteria: **Near Current Position**, **Near What City?** (requires entering a city name) or **Near Address** (requires entering an address).
6. The top portion of the display shows detailed information about the highlighted POI in the list. The arrow and distance indicates the direction and distance in a straight line from your current position to the POI. Use the Prev and Next buttons to step up and down the list of POIs found. Tap on the POI name to continue.
7. Select the route method and tap on the orange **Calculate Route** button to begin.



Sample Restaurant Sub Category List



Restaurants Near Current Position

Creating a Route to a POI by Name

1. From the *Main Menu*, tap the **Points of Interest** icon.

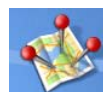

2. Select **Search by Name**.
3. Spell the name of the POI to be used as the destination. You need not enter the full name, but the more characters you enter, the easier it will be to find the exact POI you are searching for.
4. Select the search criteria: **Near Current Position, Near What City?** (requires entering a city name) or **Near Address** (requires entering an address).



Sample Search by Name Input

5. The top portion of the display shows detailed information about the highlighted POI in the list. The arrow and distance indicates the direction and distance in a straight line from your current position to the POI.

Not that searching by name will show all POIs that meet the name criteria, regardless of category. In the sample shown here, there are home improvement centers (Lowe's) and parks (Lowell Brandt Park).

Use the Prev and Next buttons to step up and down the list of POIs found. Tap on the POI name to continue.



Search Result for LOWE Near Position

6. Select the route method and tap on the orange **Calculate Route** button to begin.

Enhanced POIs

Enhanced POIs are points of interest that are user-created using the POI Manager software found on the CD-ROM. After loading a POI file to an SD / MMC card and loading it in the Magellan Maestro, you can route to those POIs quickly.

Loading a POI File

1. Save a POI file created with the POI Manager to an SD/MMC card and install the card in the SD/MMC slot on the left side of the Magellan Maestro.

2. From the *Main Menu*, tap the **Points of Interest** icon.

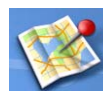

3. Select **Enhanced**.
4. Select **My POI**.

5. Select **Change My POI File**.
6. Select **Select a POI File**.
7. Select the POI file to be loaded from the list of available POI files by tapping on the file name.

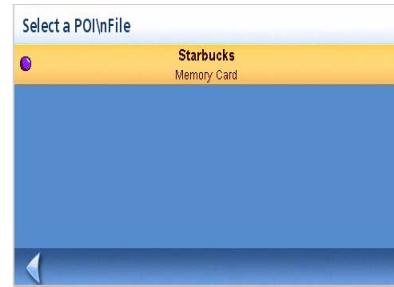

POI File List

Selecting Categories for Display on the Map

A POI file must be loaded (see *Loading a POI File*) for this function to operate.

1. From the *Main Menu*, tap the **Points of Interest** icon.
2. Select **Enhanced**.
3. Select **My POI**.
4. Select **Change My POI File**.
5. Select **Display Categories**.
6. Use the checkbox to the left of the category name to select or deselect the category. (Checked means this category will have its icon displayed on the map.)

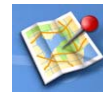

Tap **Mark All** to check all categories or **Clear All** to uncheck all categories.

7. Tap **Save** when done.

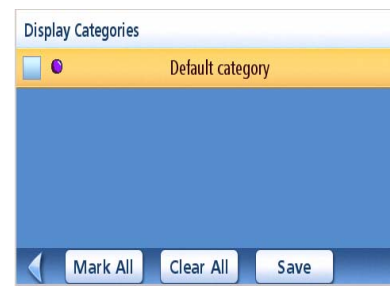

Enhanced POI Category List

Setting Alarms

A POI file must be loaded (see *Loading a POI File*) for this function to operate. An enhanced POI can have an alarm that will alert you when you are in range set by "Alert Parameters." Note that all POIs in the categories selected will have their alarms set to on. A POI file must be loaded (see *Loading a POI File*) for this function to operate.

1. From the *Main Menu*, tap the **Points of Interest** icon.
2. Select **Enhanced**.
3. Select **My POI**.



4. Select **Change My POI File**.
5. Select **Set Alarms**.
6. Use the checkbox to the left of the category name to select or deselect the category. (Checked means this category will have its alarms turned on.)
Tap **Mark All** to check all categories or **Clear All** to uncheck all categories.
7. Tap **Save** when done.

Setting Alarm Parameters

An enhanced POI can have an alarm that will alert you when you are in range set by "Alert Parameters." Note that all POIs in the categories selected will have their alarms set to on. A POI file must be loaded (see *Loading a POI File*) for this function to operate.

1. From the *Main Menu*, tap the **Points of Interest** icon. 
2. Select **Enhanced**.
3. Select **My POI**.
4. Select **Change My POI File**.
5. Select **Set Alarms**.
6. Select the category from the category list whose alarm parameters are to be changed.
7. Set the detection angle, the first warning and the last warning by tapping on the button with the current setting.
8. Use the keypad to enter in new values and tap **OK**.
9. Tap **Save** when done.

Routing to an Enhanced POI

A POI file must be loaded (see *Loading a POI File*) for this function to operate.

1. From the *Main Menu*, tap the **Points of Interest** icon. 
2. Select **Enhanced**.
3. Select **My POI**.
4. Select **Select Category**.
5. Select the category containing the POI you want to route to from the category list.
6. Select **Nearest** (near your current position) or **Spell POI Name** (requires entering the POI name).
7. Select the POI to be routed to from the "Select POI" list.

8. Tap **Route**.
9. Select the routing method desired and tap the orange **Calculate Route** button to continue.

Saving an Enhanced POI to Your Address Book

A POI file must be loaded (see *Loading a POI File*) for this function to operate.

1. From the *Main Menu*, tap the **Points of Interest** icon. 
2. Select **Enhanced**.
3. Select **My POI**.
4. Select **Select Category**.
5. Select the category containing the POI you want to route to from the category list.
6. Select **Nearest** (near your current position) or **Spell POI Name** (requires entering the POI name).
7. Select the POI to be routed to from the “Select POI” list.
8. Tap **Save**.
9. Edit the POI information and tap **Save**.
10. The *Route To This POI* screen is displayed again. Tap on **Route** to create a route or **Cancel** to quit.

AAA TourBook®

The AAA TourBook® is a special feature of the Magellan Maestro that gives users access to a special set of POIs from the AAA TourBook®. Please see the chapter on the AAA TourBook® for complete details.

Travelling on a Route

Map Screen

When a route has been calculated it will be displayed on the *Map* screen in green with blue arrows indicating direction of travel. The top of the screen displays the name of the street you are on. The bottom provides information about the next maneuver needed.

The sample to the right shows that the next maneuver will be to turn right in 3.3 miles on Fairplex Dr. The total distance to the destination is 4.7 miles.

As the route progresses, voice alerts will be used to prompt you of upcoming maneuvers. If you miss a prompt, or want it repeated, tap on the 'next maneuver in xxx mi.'" data field.

There is also a bell that will alert you where the maneuver is to be performed. (This tone can be changed in User Options > Tone Options.)

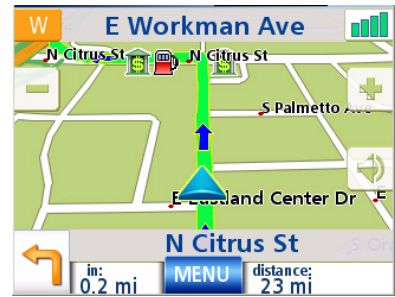

Map Screen with Route Shown

Split-Screen

As a maneuver is approached, the Magellan Maestro displays a split-screen alerting you of the upcoming maneuver. This screen will close automatically as the maneuver gets closer or you can tap **ESC** to close this screen and return to the *Map* screen. (This screen can be set to not display in User Options > Map Options.)



Split-Screen

Maneuver List

The Maneuver List displays all of the maneuvers needed to be made to complete the route and arrive at the destination. To view the Maneuver List, tap on the maneuver icon in the bottom left corner of the *Map* screen. (The Maneuver List is described in detail in the Map chapter of this manual.)



Maneuver List

You Have Arrived

Finally, the Magellan Maestro will provide a visual alert when you have arrived at the destination. Tap the **Back** arrow to return to the *Map* screen. (The Magellan Maestro will automatically return to the *Map* screen after a fixed time if you do not tap the **Back** arrow.)

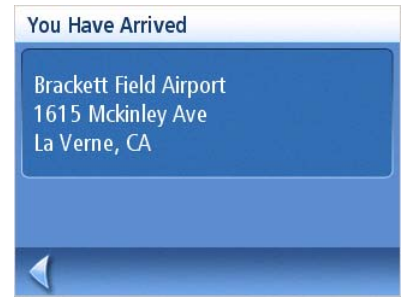

You Have Arrived.

Types of Routes

There are a wide variety of ways to create a route and each of them are discussed in the chapter that they are associated with. Some of the more common methods and the chapter they are described are:

- A route to a new address (*Street Address*)
- A route to an address in your address book (Street Address)
- A route to a Previous Destination (Street Address)
- A route to a street intersection (Street Address)
- A route to a POI preloaded in the Magellan Maestro (Points of Interest)
- A trip (a route with multiple destinations) (Trip Planner)
- A route to your home address (Home Address)

Route Method

Regardless of which route type has been created, the Magellan Maestro needs to know how the route is to be calculated. Routes can be calculated by Fastest Time, Shortest Distance, Least Use of Freeways or Most Use of Freeways. To select the route method, tap on the radio button for the desired method.

The Magellan Maestro can be set to avoid toll roads as much as possible by tapping on the Avoid Toll Roads checkbox.

The View on Map  button displays the Map screen with the destination shown. Tap on **ESC** to return to the Route Method screen.

When the route method has been selected and you are ready to begin calculating the route, tap on the Route Calculate button.



Route Method



Route Calculate button









Special Routing Functions

When a route is active, the Main Menu functions are changed to support special routing functions.

Routing to a POI Near an Approaching Freeway Exit

Note: This function is available only while on a freeway. Also, when you create a route to a POI near an exit, the original route will be cancelled. You will need to reset the original route when you are ready to continue.

1. From the *Map* screen, tap **MENU**.
2. Tap the **Exit POIs** icon. 
3. Tap on the POI icon (restaurant, gas station or hotel) for the exit required.
4. A list of POIs in the category selected that are near the exit chosen will be displayed.
5. Tap on the POI in the list that you want routing directions to.
6. Select the Route Method and tap the orange **Calculating Route** button.

Exit (mi)	Select Exit		
1.2			
2.3			
2.9			

Exit POI List

Cancelling a Route

1. From the *Map* screen, tap **MENU**.
2. Tap the **Cancel Route** icon. 
3. Confirm cancelling of the route. Tap **Yes**.

Detouring off a Route

1. From the *Map* screen, tap **MENU**.
2. Tap the **Detour** icon. 
3. Select the distance to avoid (3 mi., 5 mi., 10 mi. or Custom) that will be used to calculate the route will then put you back on the original route.
4. Tap **Route**.
5. The detour will be calculated using the same routing method used to create the route.

Changing the Route Method

If you travel off the computed route, the Magellan Maestro will automatically re-calculate the routing information to get you to your original destination using the routing method you selected when creating the route. However, if you want to change the routing method (while on or off the route), you will need to use the re-route function.

1. From the *Map* screen, tap **MENU**.

2. Tap the **Reroute** icon.



3. Select the desired routing method and tap the orange **Calculate Route** button.

Overview

AAA TourBook® travel information can help make your trip safe, easy and hassle-free. As a AAA member, Magellan Maestro offers you the exclusive advantage of discount listings wherever your AAA membership card is accepted.

AAA TourBook®

The first step is to select the *AAA TourBook® Menu*. From this menu, you can access information and directions for the following.

- AAA Approved/Diamond Rated accommodations and restaurants, and AAA recommended destinations, attractions and events.
- Businesses that participate in the **AAA Show Your Card & Save®** program.
- AAA-approved auto repair facilities.
- AAA branch offices.
- AAA-rated campgrounds.

Accessing the AAA TourBook®

- 1 From the *Main Menu*, tap **Points of Interest**.
- 2 Tap the **AAA TourBook®** button.
- 3 The AAA TourBook® Menu is displayed as shown here.



AAA TourBook® Menu

Canadian TourBook® Guides and Roadside Assistance is provided by the Canadian Automobile Association (CAA), an affiliate of AAA.

AAA TourBook® Information

Search the AAA TourBook® for information on accommodations, restaurants, destinations, attractions and events. Once selected, use the Route button to tell the Magellan Maestro to navigate you to that point of interest.

Getting AAA TourBook® Information

- 1 Access the *AAA TourBook® Menu*.
- 2 Tap on **AAA TourBook® Information**.
- 3 Tap on **Accommodations, Restaurants, Destinations, Attractions, or Events**.
- 4 Select the search criteria: **Near Current Position, Near What City?, Near Address, or Spell Name**. Follow the instructions for entering the information needed.



AAA TourBook® Information Menu

- 5 Use the **Prev** and **Next** to scroll through the list of AAA TourBook® entries.

The information at the top of the display provides you with:

- an arrow indicating the direction of the POI,
- the distance (as the crow flies) to the POI,
- the address,
- AAA's rating for the highlighted POI, and
- the phone number.



Sample Restaurant List

- 6 Tap on the POI in the list to get more information.

The tabs along the top spotlight the information that has been recorded for this location. Description, Hours of Operation, Parking/Credit Cards are just a few of the tabs that may be presented. The arrows to the right of the tabs help you step through the tabs that cannot fit on the display.



Additional Information

Routing To the Selected POI

- 1 Once the POI has been selected and the additional information is displayed (as described above), tap the **Route** button.
- 2 Select the method you want the route to be calculated and press the **calculate route** button to begin. (*For more information on routing methods see the Route chapter of this manual.*)

Show Your Card & Save®

Search for businesses that offer discounts for AAA members with the Show Your Card & Save® program. Once selected, use the Route button to tell the Magellan Maestro to navigate you to that point of interest.

Getting Show Your Card & Save® Information

- 1 Access the AAA TourBook® Menu.
- 2 Tap on **Show Your Card & Save®**.
- 3 Tap on **Accommodations/Travel, Restaurants, Attractions, Automotive, Shopping** or **Healthcare**.
- 4 Select the search criteria: **Near Current Position, Near What City?, Near Address,** or **Spell Name**. Follow the instructions for entering the information needed.
- 5 Use the and to scroll through the list of AAA Show Your Card & Save® entries.

The information at the top of the display provides you with:

- an arrow indicating the direction of the POI,
- the distance (as the crow flies) to the POI,
- the address,
- SAVE icon indicating that this is a Show Your Card & Save® business, and
- the phone number.

- 6 Tap on the POI in the list to get more information.

The tabs along the top spotlight the information that has been recorded for this location. Method of Business, Offer Type, and Service Description are just a few of the tabs that may be presented. The arrows to the right of the tabs help you step through the tabs that cannot fit on the display.



Show Your Card & Save Menu



Sample Attraction List

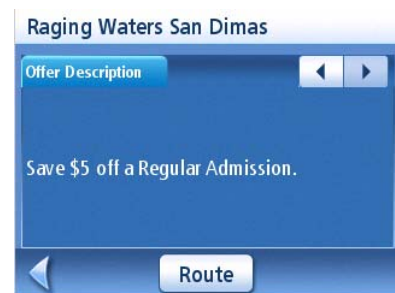

Additional Information

Routing to the Selected POI

- 1 Once the POI has been selected and the additional information is displayed (as described above), tap the button.
- 2 Select the method you want the route to be calculated and press the calculate route button to begin. (For more information on routing methods, see the Route chapter of this manual.)

Approved Automotive Repairs

Search for AAA-approved automotive repair facilities for detailed information on hours of operation as well as services offered. Once selected, the Magellan Maestro can provide you with routing instructions.

Getting Approved Automotive Repair Information

- 1 Access the *AAA TourBook® Menu*.
- 2 Tap on **Approved Automotive Repair**.
- 3 Select the search criteria: **Near Current Position, Near What City?, Near Address, or Spell Name**. Follow the instructions for entering the information needed.

- 4 Use the and to scroll through the list of AAA-approved automotive repair facilities.

The information at the top of the display provides you with:

- an arrow indicating the direction of the automotive facility,
- the distance (as the crow flies) to the automotive facility,
- the address, and
- the phone number.

- 5 Tap on a automotive facility in the list to get more information.

The tabs along the top spotlight the information that has been recorded for this location. Hours of Operation and Services Offered tabs may be presented. The arrows to the right of the tabs help you step through the tabs that cannot fit on the display.



Sample Approved Auto Repair List



Additional Automotive Repair Information

Routing to the Selected Automotive Facility

- 1 Once the automotive facility has been selected and the additional information is displayed (as described above), tap the button.
- 2 Select the method you want the route to be calculated and press the calculate route button to begin. (*For more information on routing methods see the Route chapter of this manual.*)

AAA Branch Offices

Search for AAA branch offices with information on hours of operation and services offered. Once selected, use the Route button to tell the Magellan Maestro to navigate you to that AAA branch office.

Getting AAA Branch Office Information

- 1 Access the *AAA TourBook® Menu*.
- 2 Tap on **AAA Branch Offices**.
- 3 Select the search criteria: **Near Current Position**, **Near What City?**, **Near Address**, or **Spell Name**. Follow the instructions for entering the information needed.
- 4 Use the and to scroll through the list of AAA branch offices.

The information at the top of the display provides you with:

- an arrow indicating the direction of the branch office,
- the distance (as the crow flies) to the AAA branch office,
- the address, and
- the phone number.

- 5 Tap on the AAA branch office in the list to get more information.

The tabs along the top spotlight the information that has been recorded for this location. Hours of Operation and Services Offered can be viewed by tapping the appropriate tab.



Sample Branch Office List

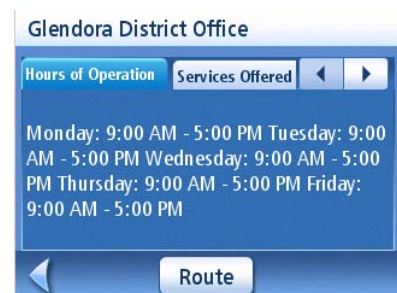

Additional AAA Branch Office Information



Routing to the Selected AAA Branch Office

- 1 Once the branch office has been selected and the additional information is displayed (as described above), tap the button.
- 2 Select the method you want the route to be calculated and press the calculate route button to begin. (*For more information on routing methods see the Route chapter of this manual.*)

Campgrounds

Search for campgrounds that have been rated by AAA. Once selected, use the Route button to tell the Magellan Maestro to navigate there.

Getting Campground Information

- 1 Access the *AAA TourBook® Menu*.
- 2 Tap on **Campgrounds**.
- 3 Select the search criteria: **Near Current Position, Near What City?, Near Address, or Spell Name**. Follow the instructions for entering the information needed.
- 4 Use the  and  to scroll through the list of campgrounds.

The information at the top of the display provides you with:

- an arrow indicating the direction of the campground,
- the distance (as the crow flies) to the campground,
- the address,
- AAA's rating and Show Your Card & Save[®] icon if applicable, for the highlighted campground, and
- the phone number.



Sample Restaurant List

- 5 Tap on the campground in the list to get more information.

The tabs along the top spotlight the information that has been recorded for this location. Facility/Sites, Activities/Services, and Terms/Restrictions information is accessible by tapping on the tab. The arrows to the right of the tabs help you step through the tabs that cannot fit on the display.



Additional Information

Routing To the Selected Campground

- 1 Once the campground has been selected and the additional information is displayed (as described above), tap the  button.
- 2 Select the method you want the route to be calculated and press the calculate route button to begin. (*For more information on routing methods see the Route chapter of this manual.*)

AAA Roadside Assistance

Overview

This screen contains all of the information you will need to provide AAA Roadside Assistance emergency services to your pinpoint location and speed up your service. AAA members will appreciate having the AAA toll-free number and their AAA membership number at their fingertips.

The AAA Roadside Assistance Screen



To receive AAA Roadside Assistance you need to have a AAA membership in your possession. If you are not a AAA member, use the Membership Enrollment Number to sign up.

Accessing AAA Roadside Assistance

- 1 From the Main Menu, tap on the tow truck icon.



Tap on the tow truck to access Roadside Assistance.

Entering Your AAA Membership Number

- 1 Access the Roadside Assistance screen.
- 2 Tap on .
- 3 Use the keyboard to enter your AAA membership number. Tap when done.

Trip Planner

The Trip Planner is used to create a route with multiple destinations. In this document we refer to a route with multiple destinations as a “Trip”.

Creating a Trip

1. From page 2 of the Main Menu, tap the **Trip Planner** icon.
2. Select **New** from the Trip Planner Menu.
3. Use the keypad to enter in a name for this trip.
4. Tap **OK**.



Enter a Trip Name

5. Begin by adding the first destination in the trip. Tap **Add**.
6. Select the method to be used to find or create the destination icon: **Enter Address, Address Book, POIs, or Intersection**.
7. Follow the instructions for the method chosen to select the destination.

See the chapters on *Enter Address* and *POI* for help in selecting destinations.

8. When the destination is found the *Add Address to Trip* screen is displayed. Tap **Save**.

Tap add to begin

Tap Save to Add the Address

- The list of trip destinations is displayed.



First Destination Added

- Tap on the destination name to bring up the menu.

Shortcut: if you just want to append a destination to the list, use the **Append** button at the bottom of the display.

- Repeat steps 5 through 9 until the trip is complete with all desired destinations.

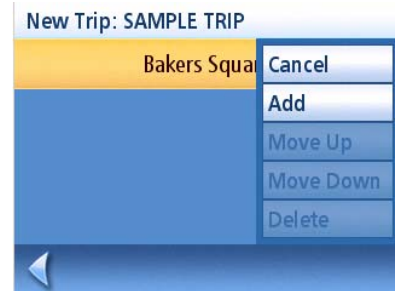

Tap on Heroes Bar & Grill to open menu.

- Tap **Save**.

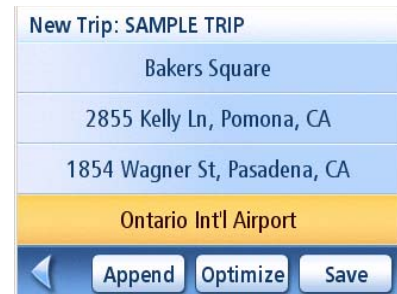

Saving completed trip.

Optimizing a Trip

While creating a trip or editing a trip you can optimize the order of the destinations but using the Optimize button.

- View the trip list, either while creating the trip or from the **Edit** button when selecting **Trip Planner**.
- Tap **Optimize**.
- Tap **Save** to store the changes to the trip.

Starting a Trip

1. From page 2 of the Main Menu, tap the **Trip Planner** icon.
2. Select **Guide Me** from the Trip Planner Menu.
3. Select the trip to be used from the stored trips list.
4. Tap on the destination in the list to be used to as the first destination in the trip.

In the example shown, tapping on 'Heroes Bar & Grill' (first destination in the list) would activate a trip that be from your current position to Heroes Bar & Grill, then Pasadena, CA, then Arcadia, CA and finally Home.

Tapping on the destination in Pasadena, CA would activate a trip that goes from your current position to Arcadia and then Home.

5. Select the routing method to be used and tap the orange **Calculate Route** button.

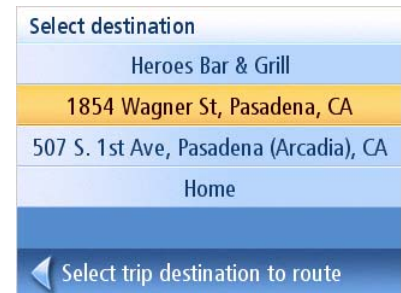

Select first destination.

Editing a Trip

1. From page 2 of the Main Menu, tap the **Trip Planner** icon.
2. Select **Edit** from the Trip Planner Menu.
3. Select the trip to be edited from the stored trips list.
4. Tap on the destination to be edited. You can:

Add a destination following the one selected.

Move the destination up in the list.

Move the destination down in the list.

Delete the destination from the trip.

5. When the trip has been edited, tap **Save**.

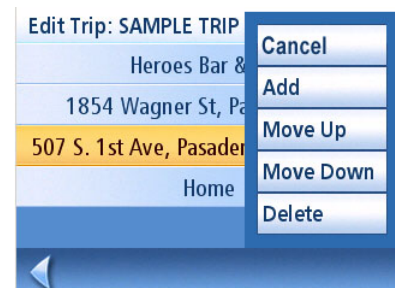

Edit Trip

Deleting a Trip

1. From page 2 of the Main Menu, tap the **Trip Planner** icon.
2. Select **Delete, Rename** from the Trip Planner Menu.



3. Tap **Delete**.
4. Select the trip to be deleted from the stored trips list.
5. Confirm the deletion of the trip. Tap **Yes**.

Renaming a Trip

1. From page 2 of the Main Menu, tap the **Trip Planner** icon. 
2. Select **Delete, Rename** from the Trip Planner Menu.
3. Tap **Rename**.
4. Select the trip to be renamed from the stored trips list.
5. Use the keypad to edit the name of the trip.
6. Tap **OK**.

Exit POIs

The Exit POI function provides a way of accessing commonly used POIs that are near an exit you are approaching while travelling on a freeway. Exit POIs include restaurants, gas stations and hotels. Exit POIs can be accessed while on a route or just driving, as long as you are on a freeway.

Routing to a POI Near an Approaching Freeway Exit

Note: This function is available only while on a freeway. Also, when you create a route to a POI near an exit, the original route will be cancelled if you are travelling on a route. You will need to reset the original route when you are ready to continue.

1. From the *Map* screen, tap **MENU**.
2. Tap the **Exit POIs** icon. 
3. Tap on the POI icon (restaurant, gas station or hotel) for the exit required.



Exit POI List

4. A list of POIs in the category selected that are near the exit chosen will be displayed.
5. Tap on the POI in the list that you want routing directions.
6. Select the Route Method and tap the orange **Calculating Route** button.



Sample List of Automotive POIs

Bluetooth

Introduction

The Bluetooth function of the Magellan Maestro allows you to use the Magellan Maestro as a hands-free device for a *Bluetooth* enabled mobile phone. You can answer and dial your phone by using the Magellan Maestro touchscreen..

Accessing the Bluetooth Main Menu

1. From the *Main Menu* screen, tap 

:



Bluetooth Main Menu

Pair Mode

If this is the first time the feature is used and no mobile phone is paired or connected, the system will automatically switch “Pair Mode” and will wait for you to pair your mobile phone.

To pair a new phone or if the automatic pairing at first use was cancelled, you must pair the phone with the Magellan Maestro before the Bluetooth function can be used.

Pairing a Phone to the Magellan Maestro

1. Access the *Bluetooth Main Menu*.

2. Tap on the **Pair with a Device** icon. 

3. The pairing search screen is displayed.

Pairing will fail if the process cannot be finished within 1 minute.

4. To pair your mobile phone, please consult the user manual for your mobile phone.

During the pairing process on your mobile phone you will be asked to input a passkey. You can input any combination of numbers but 1111 is suggested.

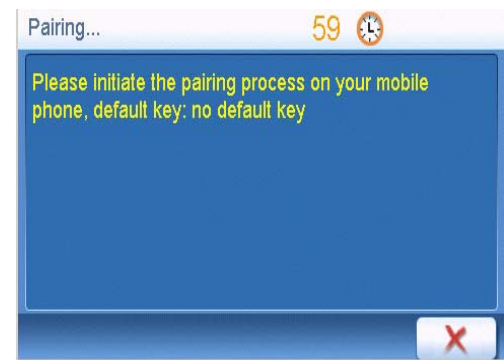

Pairing Search

5. A passkey input window will pop up on your Magellan Maestro. You need to input the same numbers as you input to your mobile phone to this pop up window.



Passkey Request screen

Establish Connection

Once paired you will still need to establish connection with the mobile phone if the message “No paired phone connected” appears at the bottom of the *Bluetooth Main Menu* screen.



If your mobile phone doesn’t support “Hands-free” service and just supports the “Headset” service, you needn’t connect. If you dial a number out from your mobile phone or incoming call the “Headset” service shall be connected automatically. The main interface shall show up with a status message “xx connected, partial function supported only”,

Establishing a Bluetooth Connection

1. Access the *Bluetooth Main Menu*.
2. Tap the **Search for Devices** icon. 
3. The Searching for devices screen will appear. Once a device is found it will return to the Bluetooth Main Menu with a message at the bottom of the screen indicated that a device is connected.

Place a call

Placing a Call

1. Access the *Bluetooth Main Menu*.
2. Tap the **Call** icon. 
 - You can input 13 characters: “0~9”, * and # with the buttons in the keypads. Input “+” by pressing * for about 1 second.
 - You can tap  to delete the phone number you have input. Press the button for about half a second and the entire row will be deleted.



Call screen

- Once you have input the phone number you want to dial, tap  to place the call.



Placing a Call Using the Address Book

- Access the *Bluetooth Main Menu*.
- Tap the **Call** icon. 
- Select the search criteria; **List All** or **Search Address Book**.
- After searching or listing your entire address book, select the address from the list shown.
- If there is a phone number recorded for the address the “w:” (work), “h:” (home) or “m:” (mobile) will appear as a button. Tap the desired button and the call will be initiated.

Placing a Call Using Call History

The “Call History” window displays a list of Incoming / Outgoing / Missed. calls.

- Access the *Bluetooth Main Menu*.
- Tap the **Call History** icon. 
- Select the type of calls to be displayed.

-  Incoming Calls
-  Outgoing Calls
-  Missed Calls

- Tap  to call back.



Call screen



Tap  to delete a record selected. Tap  to delete all records on the page.

Placing a Call Using Redial

- Access the *Bluetooth Main Menu*.
- Tap the **Redial** icon. 





Failed Call

If a call fails due to network trouble or other unknown reasons, the “Dialing Failed” window will pop up:

- Tap  to redial.
- Tap  to cancel dial.

Call Connected

If a call connects, the “Connected” window shall pop up:



- Tap  to display a keypad to input the extension after connected.
- Tap  to transfer the call to your mobile phone.
- Tap  to turn off the microphone in the Magellan Maestro.
- Tap  to hang up the call.



Connected screen

Incoming call

Answering an Incoming Call

1. When there is an incoming call, the “Incoming Call” window will pop up:
 - Tap  to pick up the incoming call.
 - Tap  to mute the incoming call ring.
 - Tap  to reject the incoming call.

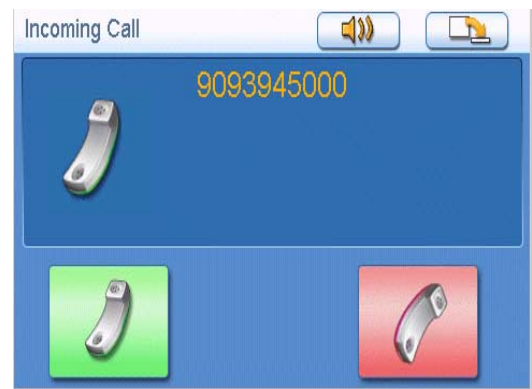

Incoming Call

Voice Control

The Magellan Maestro includes voice control software for many of the most commonly used commands. This provides hands-free operation of the Magellan Maestro for most of the functions you will use on a daily basis.

Activating Voice Control

To place the Magellan Maestro in a 'listening' mode for voice commands, you need to first 'wake up' the voice control software by speaking the attention word "Magellan". Upon waking up the Magellan Maestro, the Say a Command screen is displayed. This is a list of available commands that can be used for reference. The command you want to use does not need to be displayed, this list is for easy reference only.

1. Speak "Magellan".
2. Speak the command.

Speaking "Previous" or "Next" scrolls the list up and down.

After speaking the command, additional screens may be displayed that also can be voice controlled.



Command List

Sample Nearest Restaurant

1. Speak "Magellan".
2. Speak "Nearest Restaurant".



3. Speak “Chinese Food”.

Speak the number of the item in the list to select it. Speak “Previous” or “Next” to scroll up and down the list of items.

Say the number of the restaurant you want to go to and the Magellan Maestro will begin calculating the route to the chosen destination.

Say a Command’ Choices

The following is a list of common commands that can be spoken after saying the wake up word “Magellan.”

- “Roadside Assistance”
- “Where am I?” or “Current Location”
- “Go Home”
- “Nearest Restaurant”
- “Nearest Gas”
- “Nearest ATM”
- “Nearest Bank”
- “Nearest Coffee”
- “Reroute”
- “Distance to Destination”

Restaurants have a shortcut that will skip the cuisine screen shown in the sample. Instead of saying “Nearest Restaurant”, say “Nearest Chinese Restaurant”.

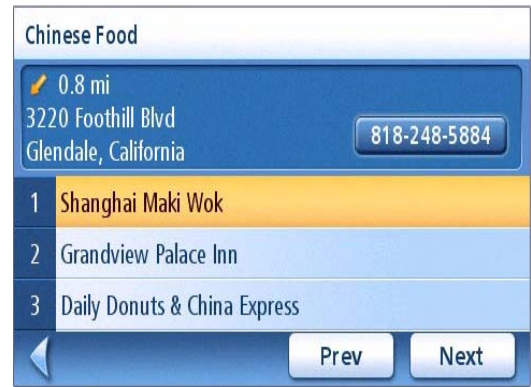

Tips on Speaking Voice Commands

No response to commands - If the navigation unit is not responding to your commands, first try relocating the Magellan Maestro so the microphone is closer and/or pointed towards you. Remember to speak in a normal, natural voice. Wind noise and talk radio stations can “confuse” the voice recognition software, so turn off the radio and roll up your windows.

- **Avoid speaking too soon.** The most common speech recognition problem people have is answering a question before the navigator has stopped speaking. The speech input circuits are inactive while the navigator is outputting speech. To avoid this problem, wait for at least one half second before answering a navigator question.
- **Turn down the radio,** especially when listening to talk radio stations.
- **Avoid speaking a command while others are talking.**
- **Avoid fans blowing across the microphone.** This problem occurs very often in summer when the air conditioning is turned up high. Turn down the fan or reposition the Magellan Maestro.
- **Roll up the window if road noise is too high.** In some cars, the interior noise increases dramatically with car speed. The best thing to do with noisy cars is to close the windows. Positioning the Magellan Maestro closer to you can also help.
- **Avoid shouting.** Shouting puts stress into the voice which actually degrades speech recognition performance. If the navigator is not hearing you, try moving the Magellan Maestro closer and lowering your voice.

Traffic

A subscription is required to be able to receive and use the traffic alert information. Included with the TrafficKit is a coupon providing you with a limited free subscription. When the free subscription is about to expire you will be prompted with information reminding you that you need to renew the subscription. You can find information about renewing your subscription at www.magellanGPS.com.

Activating the Free Subscription

1. Locate the serial number for your Magellan vehicle navigation receiver. It can be found on the back of the unit. Write this number down as you will need it later. S/N: _____
2. Locate the subscription coupon that is included in the Magellan TrafficKit. At the bottom of the coupon is a Subscription Activation Code that you will need to enter when prompted.
3. Go to www.magellanGPS.com/Traffic-Coupon and follow the instructions.
4. Write down the activation code that you receive upon completing the instructions. Code: _____
5. Turn on the receiver.
6. Access the **Traffic Options** function. (Select 'User Options' from the Main Menu.)
7. Select **Subscription** from the menu. At the Subscription screen, select **Subscribe**.
8. Using the keypad, enter the code you received in step 4 and press **OK**.
9. Your subscription is active and your vehicle navigator is *Traffic-Ready*.

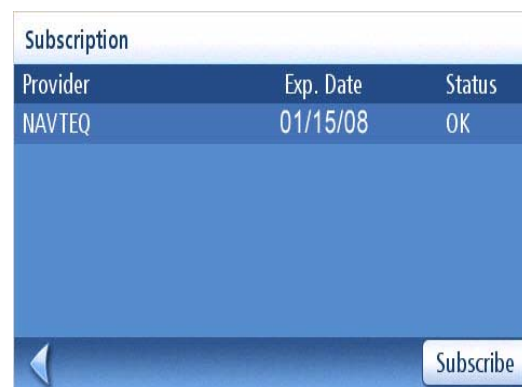

Glossary









RDS: Radio Data System. Infrastructure that broadcasts digital information on the FM band. The TrafficKit module can only receive and decode the free-access service.

TMC: Traffic Message Channel, one of the types of information that a Radio Data System can broadcast.

TrafficKit: *TrafficKit* is the Magellan brand name for the RDS-Traffic module which receives the Traffic messages.

Traffic Message: A message received by the TrafficKit module that contains the description of a Traffic event.

Traffic Event: An event liable to disturb the flow of traffic. The list of possible Traffic events that can be received are provided below, along with the corresponding road sign:

Sign	Meaning	Sign	Meaning
	Danger		Road Closed
	Slow or Stationary Traffic		Severe Weather
	Lane Reduction		Special Equipment Required
	Road Work		Vehicle Related Restriction
	Accident		

Alert Mode: Traffic events are received for informational purposes.

Re-routing Mode: This mode will reroute the vehicle if a Traffic event impacts the route, and a faster alternative route is available.

Understanding How The TrafficKit Works

Please read the following statements before using the TrafficKit.

1. You can enable and disable Traffic event categories. By default, all categories are enabled.
2. Selected Traffic events will either alert and/or re-route you depending on the operating mode.
3. All selected event categories will be displayed on the map screen in the form of traffic event icons.
4. If you are not routing to a destination, the RDS function will only display Traffic events on the map screen.

RDS-Traffic Operating Modes

Traffic events that impact your route can be processed in one of the following two modes:

Re-routing Mode. (Default) Traffic events affecting your route will trigger the receiver to automatically calculate a new route, if a faster alternative route is available.

Alert Mode. Traffic events affecting your route will be reported to you in the form of warning messages.

Selecting Categories of Traffic Events

You may choose the Traffic event categories you would like to be informed of as they occur:

1. Access the **Main Menu** and select **User Options**.
2. Scroll down the list and select **Traffic Options**.
3. Select **Incident Options**.
4. In the displayed list, check all categories of Traffic events (incidents) you want processed, and deselect events that are of no interest. For best routing Magellan recommends leaving all of the boxes checked.
5. The existing categories of Traffic events are listed at the beginning of this manual in the Glossary.
6. Checking an option in this list implies that:
7. The Map screen will show ALL the received events pertaining to this category at their respective locations.
8. Select the **Save** button to confirm all your choices.

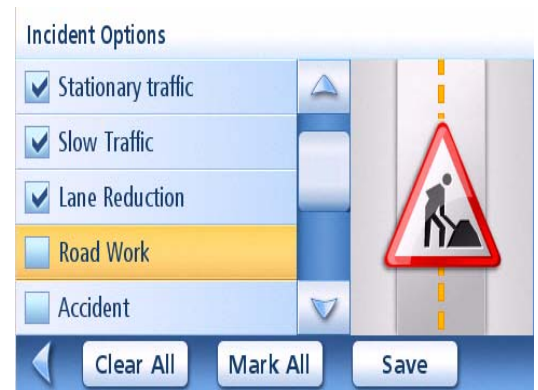

Re-routing Mode

Setting the Re-routing Mode

1. Access the **Main Menu** and select **User Options**.
2. Scroll down the list and select **Traffic Options**
3. Select **Traffic Selection**.
4. Unless already done, check the **Traffic Active** option
5. Check the **Use alternative route** option. Note that this causes the button just underneath to be renamed "Reroute option".

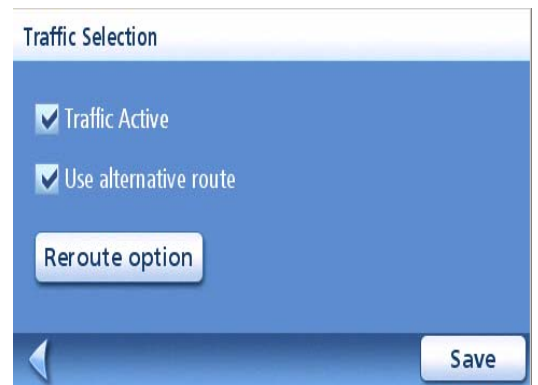

6. Select the **Reroute Option** button on the screen. A new screen appears on which you can set the distance from the event that will trigger the alternative route.



Check one of the following options:

Live Alert: With this option checked, the receiver will search for a faster alternative route whenever a Traffic event arises on your current route. This will happen at the time the event is received, regardless of your distance to the event.

Dist. to event < 40 mi: With this option checked, the receiver will re-route you only if the distance to this Traffic event, is less than 40 miles from your current location (not a point-to-point distance but that measured along the route).

Dist. to event < 20 miles: Same as above for a distance of 20 miles.

Dist. to event < 10 miles: Same as above for a distance of 10 miles.

7. Select **Save** to confirm your choice and then **Save** again to return to your guidance screen.

Traveling with the Re-routing Mode On

The following will occur whenever a Traffic event that affects your route is received:

- The receiver will analyze the impact this event will have on your route.
- A “Re-calculating the route” message will pop up on the screen along with the reason for the re-calculation.
- Once the alternate route has been computed, it will compare the alternative route with the original route, and will decide which is the best route to follow, taking time and distance into consideration.
- If the original route is still the best one to follow, the route will be unchanged, and the time portion of the status bar will be updated to reflect the delay. The traffic icon will appear in the lower right corner of the map display. Tapping this icon brings up a list of the traffic events on the route.
- If the alternative route is the best route to follow, the receiver will start guiding you along this route.
- The map screen will also show road signs corresponding to Traffic events, including those not affecting the route.
- Events that affect your route will also appear as road signs in the maneuver list.

Alert Only Mode

This mode **will not** provide you with new routing information, it will only alert you to the event.

1. Access the **Main Menu** and select **User Options**.

2. Scroll down the list and select **Traffic Options**
3. Select **Traffic Selection**.
4. Check the **Traffic Active** option and make sure the **Use alternative route** option is deselected.
5. Select the **Alert Options** button on the screen. A new screen appears on which you can set the options relevant to the Alert mode.

Check one or more of the following options:

Live Alert: When checked, the receiver will inform you of a traffic event located along your route as soon as it is detected.

Reminder at 40 mi: If you check this option, the receiver will remind you of the traffic event it has received earlier. The message will appear when this event, located somewhere along your route, is 40 miles away from your current location (not a point-to-point distance but measured along the route).

Reminder at 20 mi: Same as above but the distance from the event is only 20 miles

Reminder at 10 mi: Same as above but the distance from the event is only 10 miles

6. Select **Save** to validate your choices and then come back to your usual guidance screen.

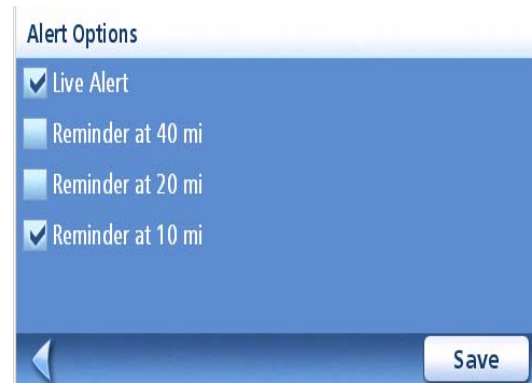

Traveling with the Alert Mode On

When you use the TrafficKit in the Alert Mode, the following will occur when new Traffic events are received:

- If an event affects your route, a warning message will appear on the screen at a time or distance defined in the Alert Options menu.
- If you do not acknowledge the message by pressing the **ENTER** button, it will automatically disappear after 10 seconds. Additional warning messages, if any, will appear in turn on the screen.
- Events that affect your route will also appear as road signs in the maneuver list, and also in the lower part of the TrueView screen.
- The map screen will show road signs corresponding to the Traffic events, including those which do not affect the route. You can obtain detailed information on any event by selecting the icon on the map screen. A dialog box will open containing a description of the event.

Traffic Alert Icon



If a traffic incident occurs on your route, the traffic alert icon will be displayed in the lower right corner of the map screen.

Viewing Traffic Details

- While viewing the Map screen and traveling on a route, tap on the Traffic Alert icon when it is displayed. A Traffic Event List is displayed with all known traffic incidents listed in order of distance from your present position on your route.
- Tap on one of the events listed to receive additional details about the traffic event.
- (Detailed information can also be displayed by tapping on an event icon displayed on the map.)

Viewing Traffic Details at Higher Zoom Levels

To avoid cluttering the screen, as you zoom out beyond the 8-mile zoom level, only the following events are displayed:

- Accidents
- Slow traffic (moving less than 20 mph)
- Road closed
- Special equipment required
- Severe weather.

How To Disable the RDS

When you do not want to use the RDS function:

1. Access the **Main Menu** and select **User Options**.
2. Scroll down the list and select **Traffic Options**
3. Select **Traffic Selection**.
4. Deselect the **Traffic Active** box
5. Click **Save** to confirm your choice.

When the RDS function is off all incoming Traffic messages are ignored.

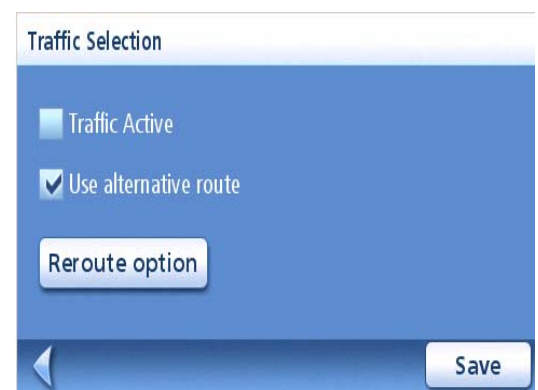

FAQs

Q1- *How does the TrafficKit module choose the frequency on which to receive Traffic data?*

A1: This is an automated procedure. When you turn on the system, the TrafficKit module analyzes the 5 best frequencies stored in its memory. These frequencies are classified in order of signal strength. The module then tests if Traffic data is available on the first station. If the first station is sending Traffic messages, the module will stay on that frequency, otherwise it will test the next one until it finds a station that delivers Traffic data.

If none of the 5 frequencies can be used, the TrafficKit module will start scanning the entire FM band. It will search for the best five frequencies on which Traffic data is available and will tune in to the strongest station. These five best frequencies will be saved in memory to be used the next time the system is powered up.

Q2- *Why do we have to wait between 2 and 5 minutes before the RDS module starts delivering RDS data?*

A2: This is the average time for the module to test all the possible frequencies on the FM band and choose the best one in terms of signal level and Traffic data availability/quality.

User Options

Use User Options to customize the Magellan Maestro to better suit your needs from a GPS navigator. Tapping the **Back** arrow from any of the *User Option* screens will cancel the changes.

Selecting Map Region

Choose the map region you will be travelling in.

1. From page 2 of the Main Menu, tap **User Options**.
2. Tap **Region**.
3. Tap on the desired map region (Lower 48 States, Canada, Alaska, Hawaii, or Puerto Rico).

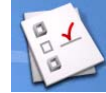

Accessing System Settings

Commonly used settings are found in the System Settings section of User Options.

1. From page 2 of the Main Menu, tap **User Options**.
2. Tap **System Settings**.

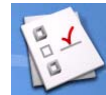

Checking Battery Life

1. From page 2 of the Main Menu, tap **User Options**.
2. Tap **System Settings**.
3. The battery life indicator is found at the bottom of the screen. All green indicated full battery life.

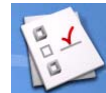

Adjusting the Volume

Volume can also be adjusted by tapping on the speaker icon on the *Map* screen.

1. From page 2 of the Main Menu, tap **User Options**.
2. Tap **System Settings**.
3. Tap **Volume**.
4. Tap along the adjustment bar to increase or decrease the speaker volume.
5. Tap **Mute** to turn the speaker off. Tap **Mute** again to turn the speaker back on.
6. Tap **Save**.

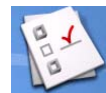

Adjusting the Display Brightness

1. From page 2 of the Main Menu, tap **User Options**. 
2. Tap **System Settings**.
3. Tap **Brightness**.
4. Tap along the adjustment bar to increase or decrease the display brightness.
5. Tap **On-battery dimming (75%)** to set it on or off. (Checked is on.) Checking it on will save battery life while operating the Magellan Maestro without external power.
6. Tap **Save**.

Setting Auto Power Off Time

The auto power setting will define the time that the Magellan Maestro will automatically turn off if it hasn't moved or the touchscreen accessed.

1. From page 2 of the Main Menu, tap **User Options**. 
2. Tap **System Settings**.
3. Tap **Power**.
4. Select **Never**, **10 Minutes**, **20 Minutes** or **30 Minutes**.
5. Tap **Save**.

Setting Time Zone

1. From page 2 of the Main Menu, tap **User Options**. 
2. Tap **System Settings**.
3. Tap **Time Zone**.
4. Use the “-” and “+” buttons to set through the time zones until the time zone for your area is displayed.
5. Check Daylight Savings if daylight savings is in effect for your time zone. (Daylight savings is not automatically adjusted.)
6. Tap **Save**.

Selecting Units of Measure

1. From page 2 of the Main Menu, tap **User Options**.
2. Tap **System Settings**.
3. Tap **Units of Measure**.
4. Select **Miles/Feet** or **Kilometers/Meters**.
5. Tap **Save**.



Displaying Contact Us Information

1. From page 2 of the Main Menu, tap **User Options**.
2. Tap **System Settings**.
3. Tap .
4. Tap **Contact Us**.
5. Tap **Back** arrow.

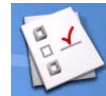

Displaying Product Information

1. From page 2 of the Main Menu, tap **User Options**.
2. Tap **System Settings**.
3. Tap **Next**.
4. Tap **Product Information**.
5. Tap **Next** to view additional product information.
Tap **Prev** to return to page 1.
6. Tap the **Back** arrow to exit.

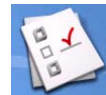

Performing Diagnostics

1. From page 2 of the Main Menu, tap **User Options**.
2. Tap **System Settings**.
3. Tap **Next**.
4. Tap **Diagnostics**.
5. Tap **Audio Test**, **Touchscreen Test** or **Video Test**.
6. When done, tap the **Back** arrow to exit.

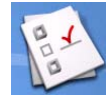

Accessing the Trip Computer

The trip computer records your average speed, the time in hours of the trip, the time in hours that you were driving, and the distance of the trip. This information can be saved to a file for easy access when the information is needed.

1. From page 2 of the Main Menu, tap **User Options**.
2. Tap **Trip Computer**.
3. Select the Current Trip or a Saved Trip from the list.
4. Select **Stop** to stop recording information.

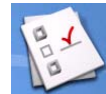

Select **Reset** to set all the information to zero. Select **Reset** when you are starting a trip or route that you want to record details for.

Current		
Running...		
Average Speed	8	mph
Trip Time	00:00	hrs
Drive Time	00:02	hrs
Trip Distance	0.3	mi

◀ Stop Reset Save

Current Trip Computer

Select **Save** to store the trip computer information to a file. You will be prompted to enter a name for the file. Input a name and tap **OK**.

5. Tap the **Back** arrow to exit.

Selecting POIs to be Displayed on the Map

In some areas the map can be cluttered with POIs making it difficult to find what you are looking for. Use POI Selection to set what categories of icons will be shown and which ones will be hidden.

1. From page 2 of the Main Menu, tap **User Options**.

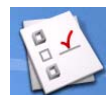

2. Tap **POI Selection**.
3. Tap on the POI category in the list to toggle its display setting on or off. (Checked POIs will be displayed.)

Tap **Mark All** to check all POI categories.

Tap **Clear All** to uncheck all POI categories.

4. Tap **Save** to save changes and exit.



POI Selection Screen

Deleting Addresses from the Address Book (Global)

The chapter on addresses discusses how to delete individual addresses from the address book. Address Book Options provides a way of globally deleting addresses from the address book.

1. From page 2 of the Main Menu, tap **User Options**.

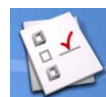

2. Tap **Address Book Options**.
3. Tap **Clear Addresses** to delete all of the addresses in your Address Book.
Tap **Clear Favorites** to delete only those addresses marked as Favorites from your Address Book.
Tap **Clear Previous** to delete previous destinations from the Address Book.
4. Tap the **Back** arrow to exit.

Setting the Map in 3D or 2D Mode

See the chapter on Maps for information regarding 3D and 2D modes of the map.

1. From page 2 of the Main Menu, tap **User Options**.



2. Tap **Map Options**.
3. Select **3D Map** or **2D Map**.
4. Tap **Save** to record the changes and exit.

Setting the Map Display to Heading Up or North Up

The map can be displayed with the top of the display in the direction of your heading or North.

1. From page 2 of the Main Menu, tap **User Options**.
2. Tap **Map Options**.
3. Select **Heading Up** or **North Up**. (Note, North Up is available only when the map is set to 2D mode.)
4. Tap **Save** to record the changes and exit.

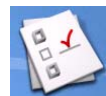

Setting Split Screen (TrueView™) Options

As you approach a maneuver, the display changes to the split screen mode. Under Map Options you can turn off the split screen or set it to be just the TrueView portion of the split screen.

1. From page 2 of the Main Menu, tap **User Options**.
2. Tap **Map Options**.
3. Tap **Auto TrueView** to turn set it to on or off. (Checked is on and the TrueView image will be displayed.)
4. Tap Split TrueView to set the TrueView display to split or single view. (Checked sets split screen on.)

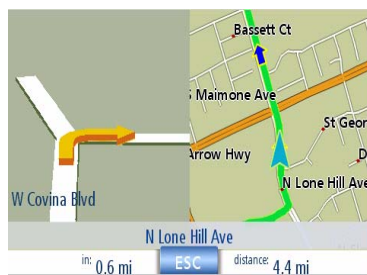
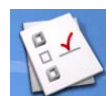

TrueView Split Screen



TrueView Single Screen

5. Tap **Save** to record the changes and exit.

Setting Auto Night Map Display

Normally the map is displayed in the pastel colors for daytime use and a black background for nighttime use. Unchecking the Auto Night Mode will keep the map display using the pastel colors.

1. From page 2 of the Main Menu, tap **User Options**.
2. Tap **Map Options**.
3. Tap on **Auto Night Mode**. (Checked indicates that the map will automatically change to night colors; unchecked and the map will always use the day colors.) Note: If the screen has

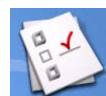

already switched to night colors, unchecking the box will not cause the display to go to the day colors. The switch to day colors will occur the following morning and then stay in day colors.)

4. Tap **Save** to record the changes and exit.

Setting Detour Options

Normally the map is displayed in the pastel colors for daytime use and a black background for nighttime use. Unchecking the Auto Night Mode will keep the map display using the pastel colors.

1. From page 2 of the Main Menu, tap **User Options**.

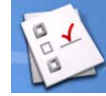

2. Tap **Detour Options**.
3. Select the default for the distance to be used to detour around traffic problems while routing.

Set the alert timer. (Enter the time from the keypad.)

Check Enable automatic detour on or off. (Checked is on and the Magellan Maestro will automatically offer detour routing when it computes you are stuck in slow or stopped traffic situations.)

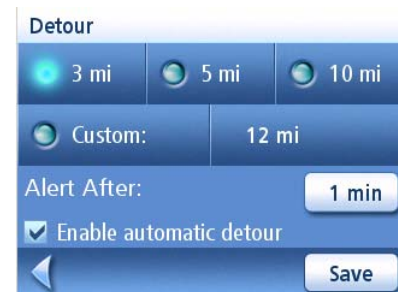

Detour Options Screen

4. Tap **Save** to record the changes and exit.

Using the Simulator

When turned on, the simulator will offer the option of simulating movement on a route. Useful for learning about the Magellan Maestro while not driving.

1. From page 2 of the Main Menu, tap **User Options**.

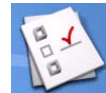

2. Tap **Simulator Mode**.
3. Tap **Propose simulator mode when calculating route**. When checked, the Magellan Maestro will ask if you want the route simulated when it is created. Simulation mode will ignore actual movement and should only be used for training purposes.

Tap on the speed factor desired.

Tap **<<1mi** or **1m>>** to set the route forward or backwards 1 mile.

Tap **Restart** to begin the route you are currently simulating back to the beginning.

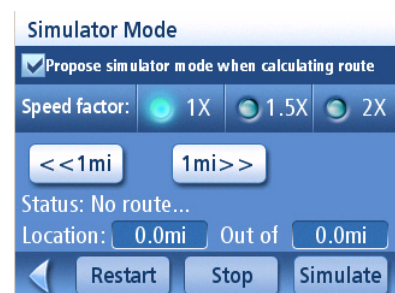

Simulator Mode Screen

Tap **Stop** to end simulating the current route you are simulating.

(The Simulate button is presently not active.)

4. Tap **Back** arrow to record the changes and exit.

Setting Tone Options

Provides a way of selecting the tone used to announce arrival at a maneuver or destination.

1. From page 2 of the Main Menu, tap **User Options**.



2. Tap **Tone Options**.
3. Select **Bell, Chime** or **Beep**.
4. Tap **Save** to record the changes and exit.

Viewing Technical GPS Information

This screen provides technical information about the satellites being used to compute the GPS position.

1. From page 2 of the Main Menu, tap **User Options**.

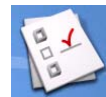

2. Tap **GPS Options**.
3. Tap **GPS Status**.

PRN: pseudo random number that identifies the satellite

AZ: Azimuth of the satellite

EL: Satellite elevation

SNR: Satellite signal-to-noise ratio

TTF: Time to First Fix (in seconds)

MFG GPS Status			
PRN	AZ	EL	SNR
00	000	00	0
01	009	02	4
02	018	04	8
04	036	08	16
05	045	10	20
06	054	12	24
07	063	14	28

TTF in second: 1; SAT(U/T): 2/3

4. Tap **Back** arrow to exit.

Setting the GPS Position

Setting a GPS position is useful if you are not getting satellite information quickly because the Magellan Maestro has travelled over 500 miles while turned off. Setting the GPS position will allow the Magellan Maestro to compute which satellites are available and calculate the position quicker.

1. From page 2 of the Main Menu, tap **User Options**.

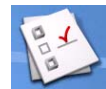

2. Tap **GPS Options**.
3. Tap **Set GPS Position**.
4. Follow the prompts to enter the address where you currently are.
5. Tap **Done** when finished entering the address.

Backing Up and Restoring Data

Backup and restore provides a way of storing the address book and other data to a SD/MMC card. When the data has been backed up, it can be restored at any time. Please note that when you restore from backed up data, address book and other data will be replaced with the data. The Magellan Maestro cannot append backed up data to your existing data.

Backing Up Data

1. From page 2 of the Main Menu, tap **User Options**. 
2. Insert a SD or MMC card with available space into the SD slot of the Magellan Maestro. Note that backing up data will overwrite any back up files on the SD or MMC card.
3. Tap **Backup and Restore**.
4. Tap **Backup**.
5. Confirm backup. Tap **Yes**.
6. Operation successful! Tap **OK**.
7. Tap **Back** arrow to exit.

Restoring Data

1. From page 2 of the Main Menu, tap **User Options**. 
2. Insert a SD or MMC card with available space into the SD slot of the Magellan Maestro. Note that backing up data will overwrite any back up files on the SD or MMC card.
3. Tap **Backup and Restore**.
4. Tap **Restore**.
5. Confirm restore. Tap **Yes**.
6. Operation successful! Tap **OK**.
7. Tap **Back** arrow to exit.

Viewing Map Information

1. From page 2 of the Main Menu, tap **User Options**. 

2. Tap **Map Information**.
3. Tap **Back** arrow to exit.



Map Information	
Geographic Area:	USA
Basemap NavStreets version:	27
Detailed map NavStreets version:	27
Map Library Version:	v.36
Navigator Build Date:	Feb 28 2007

Map Information Screen

Free Manuals Download Website

<http://myh66.com>

<http://usermanuals.us>

<http://www.somanuals.com>

<http://www.4manuals.cc>

<http://www.manual-lib.com>

<http://www.404manual.com>

<http://www.luxmanual.com>

<http://aubethermostatmanual.com>

Golf course search by state

<http://golfingnear.com>

Email search by domain

<http://emailbydomain.com>

Auto manuals search

<http://auto.somanuals.com>

TV manuals search

<http://tv.somanuals.com>