

# 750<sub>M</sub><sup>™</sup>

## *Vehicle Navigation System*

*Installation & Reference Addendum*



*Vehicle Navigation Made Portable*

# MAGELLAN

## TABLE OF CONTENTS

# *The Magellan 750M™*

## *Vehicle Navigation Made Portable™*

<b>Precautions</b> .....	2
<i>Important Information: Please Read This First!</i>	
DO .....	2
DO NOT .....	2
Battery Precautions .....	3
<b>Components</b> .....	4
<b>Installation Preparation</b> .....	6
DO .....	6
DO NOT .....	6
Component Placement .....	7
Battery Connection .....	8
Moving from Fixed Vehicle Mount .....	9
<b>Installation</b> .....	10
<b>Initialization</b> .....	13
<b>Calibration</b> .....	15
Full Calibration .....	15
Quick Calibration .....	17
<b>Operations</b> .....	18
Battery Charger .....	18
Battery Operation / Stand-Alone Mode .....	18
Map Area Switching .....	19
Preparing Navigation Computer for 750NAV .....	
In-Vehicle Fixed Installation .....	19
<b>Storage</b> .....	20
<b>Troubleshooting</b> .....	21
<b>750M Care and Maintenance</b> .....	25
<b>750M Replacement Parts</b> .....	25
<b>Battery Replacement &amp; Disposal</b> .....	26
<b>Map Area Illustration</b> .....	27

# PRECAUTIONS



*This symbol is intended to alert the user to the presence of important operating instructions. Failure to heed the instructions can result in injury or material damage.*



*This symbol indicates information which can be helpful in the use of the 750M Navigation System.*

## **Important Information: Please Read This First!**

**To reduce the risk of personal injury, please follow these important Dos and Do Nots....**

### **DO...**



- Secure the Display to ashtray, glove box or other suitable location.



- Make certain GPS Antenna Wire is not in driver's or passengers' way when placed on vehicle roof.

### **DO NOT...**



- **DO NOT** expose the 750M™ to damp locations or to any type of fluids.



- **DO NOT** place Carry Case on dashboard, rear deck or in truck bed.



- **DO NOT** place Display on a seat or in a location where it is not secure.







- **DO NOT** operate system without the Battery attached to the Battery Cable.











- **DO NOT** obstruct any airbag or other vehicle safety device.

## BATTERY PRECAUTIONS

### DO...

-  • Only charge the Battery using the Battery Charger supplied to avoid damage.
-  • The Battery contains diluted sulfuric acid, a very toxic substance. If sulfuric acid contacts skin or clothing, immediately wash with plenty of clean water. If the acid splashes into eyes, immediately flush with plenty of clean water and consult a physician. Sulfuric acid in the eyes may cause a loss of eyesight and acid on the skin will cause burns.
-  • Check the Battery for any sign of irregularities in appearance. If any cracks or deformities are noticed, replace the Battery with a new one. Call Magellan Customer Service center at 1-877-4CARNAV (1-877-422-7628) for a replacement.
-  • Avoid mechanical shock to Battery such as dropping which may cause damage and/or deterioration to the Battery.

### DO NOT...

-  • **DO NOT** connect the Battery to direct power; use the specified Battery Charger.
-  • **DO NOT** use a dry cloth or duster to clean the Battery. Avoid static electricity that could cause the Battery to explode. If the Battery requires cleaning, disconnect the Battery from the Battery Cable and clean with a slightly damp cloth only.
-  • **DO NOT** expose the Battery to extremely hot temperatures or leave in direct sunlight, in front of a stove, or near a fire.
-  • **DO NOT** use the Battery in a dusty environment which may short the battery.
-  • **DO NOT** throw the Battery in a fire or extreme heat which may cause the Battery to emit toxic gas or explode.
-  • **DO NOT** attempt to disassemble or destroy the Battery, as injury may result.
-  • **DO NOT** allow metallic objects or liquids to contact or short-circuit the Battery terminals, as burns or injuries may result.
-  • **DO NOT** apply organic solvents such as paint thinner, gasoline, kerosene, or liquid detergents to the Battery which may cause leakage.

## COMPONENTS

**If any part is missing, please contact a Magellan retailer or Magellan's customer service department at 1-877-4-CARNAV (1-877-422-7628).**

Upon purchasing the 750M verify that the product box contains both a Carry Case (which contains all of the 750M components) and the Battery.



**Carry Case with Shoulder Strap**



**Battery**

Before installation, please verify that the pre-assembled 750M system in the Carry Case includes the following components:



**Docking Station with Navigation Computer**



**Display**



**Antenna and  
Antenna Spool**



**Quick Mount Bracket**



**Battery Charger**



**Power Adapter**



**Battery Cable**

The 750M Carry Case has been designed to provide Magellan's Portable Vehicle Navigation system with expandable functionality and user friendliness.

Special features include the Air Vents and a Communication Port Access Flap. Additionally, the system is pre-assembled and fits neatly into specialized compartments for ease of use.

The Air Vents are designed to allow proper airflow to the 750M Navigation Computer, therefore, must not become obstructed. The Access Flap is designed for accessibility to the 750M Communication Ports. As future developments of the 750M occur, such as software updates, map changes, etc., these ports will allow the user to make changes easily.

**Display,  
Antenna,  
Power  
Adapter,  
and Battery  
Charger  
Compartment**

**Computer  
and Battery  
Compartment**



**Air Vent**

**Air Vent**

**Expansion Ports  
Access Flap**

## INSTALLATION PREPARATION



**To optimize 750M operation and to reduce the risk of damage to vehicle or the 750M ...**

### **DO...**

- Position Carry Case to eliminate movement while driving with handle facing toward front of vehicle.
- Place Carry Case in the same orientation each time the system is used to reduce calibration requirements.
- Complete calibration steps when system is powered up for the first time and after the 750M has:
  - been moved to a different vehicle;
  - or has its in-vehicle location changed.
- Place GPS Antenna on vehicle roof so that it has a clear view of the sky. If obstructed by a rack or other attached roof equipment, the GPS Antenna may not receive satellite signals.

### **DO NOT...**

- **DO NOT** obstruct Carry Case Air Vents from airflow. Failure to keep Air Vents free of obstructions could cause permanent damage to the 750M Navigation Computer.
- **DO NOT** allow any part of the 750M to become wet, moist or allow any part of the 750M to become exposed to any liquids.
- **DO NOT** expose any 750M part to extreme heat or cold for extensive periods of time.
- **DO NOT** tangle, kink, or excessively twist GPS Antenna Wire when winding or unwinding from Antenna Storage Spool.
- **DO NOT** store antenna on Navigation Computer side of Carry Case.

## Component Placement

The 750M vehicle navigation system components are pre-assembled in the Carry Case as shown in the picture below with the exception of the Battery.





## Battery Connection

It is important that the Battery be connected to the Battery Cable before using the 750M system. Please be sure that the Battery is attached to the Battery Cable each time the system is used.

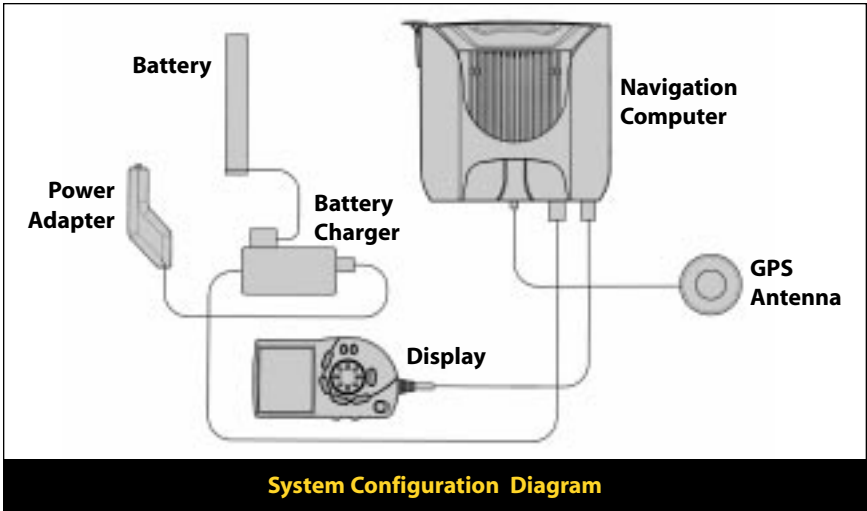

Upon first use of the 750M or if the Battery has become disconnected, be sure to connect the Battery to the Battery Cable. Verify that the Battery is connected correctly using the 'BATTERY TEST' button. When pressed, the Battery Status Indicator should illuminate indicating the charge of the battery. A reading of 70% or greater is preferred. Refer to 'Battery Charger' in the 'Operations' section for further details.



**DO NOT operate the system without the Battery attached to the Battery Cable. A 12-volt power source exists at the Battery Cable conductors even if the Battery is removed during 750M operation.**



**When unpacking Battery, check that it is free of cracks, deformities and leakage. Replace if necessary by calling Magellan Customer Service at 1-877-4CARNAV (1-877-422-7628).**



**Mount the Battery only in the upright position.**



**Battery in Upright Position**



**Correctly Installed Battery**

Open the Navigation Computer side of the Carry Case and locate the Battery Cable . Place the Battery in the Carry Case, conductor side up, under the elastic strap, and secure the fasteners. Connect the Battery Cable to the exposed metal electrodes of the Battery.

### **Moving from Fixed Vehicle Mount to Carry Case**

To remove the Navigation Computer from the fixed vehicle mount to the 750M Carry Case, follow these simple steps:

1. Pull the red locking tab on Docking Station in vehicle.
2. Grasp the Navigation Computer and pull outward.
3. Open the Navigation Computer side of the Carry Case.
4. Ensure the red locking tab is pulled out.
5. Insert the Navigation Computer into Docking Station inside the Carry Case.
6. Lock the 750M into place by pressing the red locking tab.
7. Close the Carry Case.



**Navigation Computer Removal**



**Installation in Carry Case**

# INSTALLATION

## Step 1: Place Carry Case in Vehicle

While the preferred placement of the Carry Case depends on the vehicle being driven, **ALWAYS** place case:

- On a vehicle floor or seat that allows easy driver accessibility and optimal passenger comfort;
- With its Air Vent side up and with its handle facing the front of the vehicle;
- In the **SAME** orientation each time the system is used;
- In a location where movement will be eliminated while driving;
- In a location that minimizes stress on cables.

Please refer to the examples below.



**The 750M Carry Case is equipped with Air Vents that deliver air circulation to the Navigation Computer. Failure to keep Air Vents free of airflow obstructions could cause permanent damage to the 750M system.**

## Step 2: Connect Power Adapter to Vehicle

- a) Unzip case compartment containing the Display
- b) Take out the Power Adapter
- c) Connect to the vehicle accessory power port
- d) Ensure that the Battery Charger is in the 'AUTO' position
- e) Verify that all connections to the Docking Station, Battery and Battery Charger are secure.

**TIP**

**When the Power Adapter is connected to the vehicle accessory power port, and the Battery Charger switch is in the 'AUTO' position, the 750M will automatically power up when vehicle is started and will automatically shutdown when vehicle is turned off.**

### Step 3: Antenna Setup

The GPS Antenna is located inside the Display compartment of the Carry Case.

- a) Unwind GPS Antenna Wire from the Antenna Storage Spool.
- b) Place the GPS Antenna on the vehicle roof.
- c) Verify that the end of the GPS Antenna Wire is securely attached to the rear of the Docking Station.

**TIP**

**When placing the GPS Antenna on the roof, ensure that the GPS Antenna Wire will not be severely pinched.**

**TIP**

**It is important that the GPS Antenna is in complete view of the sky and that it is not blocked by a rack or other equipment attached to the roof of the vehicle.**



**When placing GPS Antenna on the vehicle roof be certain that the GPS Antenna Wire does not interfere with vehicle operation and that it does not impede driver's or passengers' safety.**



**Avoid tangling, kinking, or excessive twisting of the GPS Antenna Wire when winding or unwinding from the Antenna Storage Spool. While unwinding and routing the Antenna Wire, inspect it for damage. If the Antenna Wire shows signs of extreme kinking or insulation damage, call Magellan Customer Service department for replacement parts at 1-877-4CARNAV (1-877-422-7628).**



**Do not pass antenna through door window to prevent damage to vehicle finish and/or antenna.**

### Step 4: Mount Display

The 750M is designed to be used in virtually any vehicle. Each user will need to find a safe, comfortable location to temporarily mount the Display. The Display should be mounted in a location that is easily viewed at a glance. With the specially designed Quick Mount Bracket attached to its back, the Display can be held in place by attaching it to an ashtray, glove compartment or other suitable location.



***When mounting the Display take care to ensure that it is clear of vehicle operation, airbags and function controls.***



***Avoid excessive force in operation! Damage may result if excessive force or leverage is applied.***



***Take care when removing or replacing the Quick Mount Bracket and be aware that heavy accidental impacts may result in damage.***



***Do not mount display in a place or manner where driver or passengers are likely to have an impact with the display in a collision or during heavy braking.***



***Securely mount the display in a manner which will not allow the display to become a projectile in a collision or during heavy braking.***



***Do not install display mount bracket into vehicle air vents as damage will occur!***

To temporarily attach the Display, follow these simple steps:

- a) Locate the center (smaller) tab of the Quick Mount Bracket and bend it outward at approximately a 45 degree angle.
- b) Select a location that will provide optimum Display viewing.
- c) Gently insert the center tab and push downward until the Quick Mount Bracket grips the surface. The Display should be held snugly against the surface and face horizontally or slightly upward.
- d) If the Display faces too far down and is difficult to view, bend the center tab outward further and bend both side (larger) tabs out as well. Try to maintain the approximate 45 degree angle between the center tab and side tabs. The angles between the Display back and the side tabs may need to be adjusted for optimum fit.

## INITIALIZATION

Initialization must be conducted prior to the first use of the 750M or when the Navigation Computer has been moved from a fixed vehicle installation in order to achieve maximum performance. Before using the 750M for the first time conduct Steps 1 through 15.

**Step 1:** Move the vehicle to an open area away from buildings, trees, and other obstructions. The vehicle must remain in an open area throughout the entire GPS initialization process.

**Step 2:** Ensure the 750M is powered on.

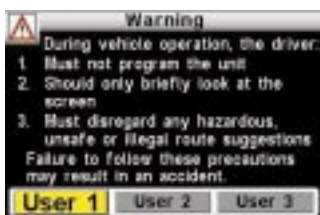

**Step 3:** After the system starts, the "Warning" screen will appear, select "User 1", press **ENTER** button on the Display.

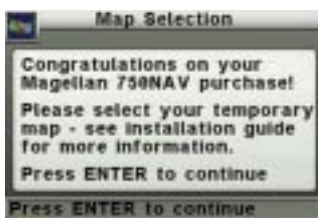

**Step 4:** If not done previously, Select a Temporary Map Area by following these steps, otherwise proceed to Step 6:

- Determine desired Map Area by referring to Map Area illustration on page 27.
- Press **ENTER**.
- Scroll down to highlight desired map Area.
- Press **ENTER**.

The system will restart itself. If unable to determine the correct Map Area or to register the system and obtain a permanent unlock code, please call Magellan Customer Service at 1-877-4CARNV (1-877-422-7628). Refer to the 750NAV manual for complete details.

**Step 5:** Select 'User 1' again, press **ENTER**.

**Step 6:** Press the **OPTION** button.



**Step 7:** Using the 8 position cursor on the Display, scroll to and select the 'Configuration' icon, press **ENTER**.

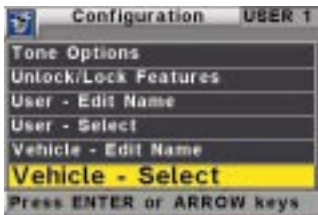

**Step 8:** Scroll to 'Vehicle-Select', press **ENTER**.

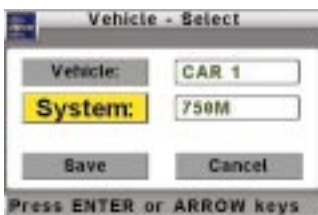

**Step 9:** Scroll to 'System' and choose '750M' by pressing **ENTER**.



**Step 10:** Scroll to 'Save', press **ENTER**. Then press **CANCEL**.



**Step 11:** Scroll to the 'Diagnostics' icon, press **ENTER**.

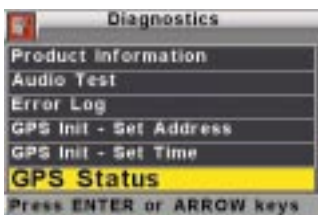

**Step 12:** Scroll to 'GPS Status', press **ENTER**.

GPS Status

CH	PRN	AZ	EL	SNR	U/N
1	17	163	40	47	U
2	9	88	50	52	U
3	21	383	44	45	U
4	15	307	42	44	U
5	26	56	19	46	U
6	23	43	73	51	U
7	29	247	38	48	U
8	3	275	14	49	U

CANCEL-exit, ENTER-next

**Step 13:** When information is displayed showing at least four (4) GPS satellites being used (indicated by a U in the U/N column), press **ENTER** to verify a position calculation.



**Step 14:** Check the latitude and longitude information and ensure that the data reads anything other than zeroes. If the system does not show GPS satellite data or a vehicle position is not generated in several minutes, go to the 'Troubleshooting' section, otherwise, GPS initialization is complete.

**Step 15:** Press the CANCEL key three (3) times to return to 'Select Destination' (Main Menu) screen.

## CALIBRATION

The 750M utilizes two calibration processes to maximize ease of use and accuracy of vehicle positioning. Full calibration offers maximum accuracy. Quick calibration requires minimal time but does not give maximum accuracy until the 750M has been driven several miles.

Complete the Full Calibration Procedure when the 750M:

- is powered up for the first time.
- has its in-vehicle location or orientation changed.

Complete the Quick Calibration Procedure when the 750M is moved from vehicle to vehicle.

No Calibration is needed if 750M system has not been moved.

### TIP

**To reduce calibration time when moving the 750M among vehicles, Magellan suggests developing calibration profiles for the different vehicles in which the 750M will be used. To do this, press the OPTION key on the Display, select 'Configuration' icon, then scroll to 'Vehicle-Edit' and press ENTER. Now input the vehicle types. For detailed instructions, please refer to the User Guide provided with the 750NAV Owner's Packet.**

### TIP

**If the 750M has not been used in two weeks or more, the satellite information will no longer be current and it may take from 12–24 minutes for the 750M to download the correct satellite information.**

## Full Calibration

**Step 1:** Move the vehicle to a safe area with reasonably flat, level terrain. Locate an area where the vehicle can be driven as straight as possible for approximately 2 blocks and where accelerating and stopping the vehicle can be done safely.



**Step 2:** If the 750M is not on, verify that the slide switch on the Battery Charger is in the 'AUTO' position then press **POWER** and allow the system to power up.

**Step 3:** Select desired user and press **ENTER** to arrive at 'Select Destination' screen (Main Menu).

**Step 4:** Press **OPTION** to arrive at 'User Options' screen.

**Step 5:** Select the 'Diagnostics' icon, press **ENTER**.

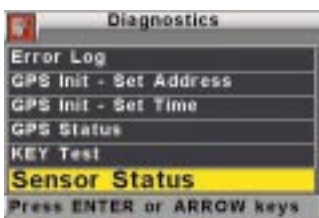

**Step 6:** Scroll to 'Sensor Status', press **ENTER**.

**Step 7:** Vehicles with automatic transmission, place foot firmly on the brake and put vehicle into drive. If using manual transmission, place foot firmly on brake and keep transmission in neutral.

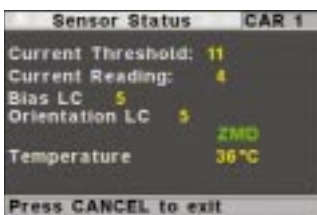

**Step 8:** Wait for the vehicle to be motionless and verify that there is a green ZMD (zero motion detected) displayed on the right center side of the screen.



**Step 9:** Press **LOCATE**. 'Computing new ZMD threshold' will appear on bottom of Display screen.

**Step 10:** Wait for 'Computing new ZMD threshold' to disappear (approximately 10 seconds).

**Step 11:** Accelerate to 10-15 miles per hour, then stop.

**TIP** *The ZMD indicator disappears when the 750M detects motion.*

**Step 12:** While stopped, wait for the ZMD indicator to reappear. Now repeat the acceleration and stop process four more times.

**TIP** *For verification, the Bias LC and Orientation LC (Learn Count) numbers must increment as the system calibrates to the vehicle. If this is not true, refer to the 'Troubleshooting' section.*



**Step 13:** Press **CANCEL** three (3) times to get to 'Select Destination' screen and then press **VIEW** to get to the 'Map' screen.

Verify that the Direction and Signal Strength Indicator located at the bottom left corner of the Display, is green, indicating that the system has located GPS satellites. If this is not true, refer to the 'Troubleshooting' section.

Ensure vehicle icon is correctly displayed on the Map or press **LOCATE** to check current location.

The 'Full Calibration' procedure is now complete and the 750M is ready for inputting a destination. For further instructions, consult the 750NAV User Manual.

### Quick Calibration

After initialization, the 'Quick Calibration' function is activated upon power up. To utilize this feature, simply follow the instructions on the Display when prompted. The steps required for a 'Quick Calibration' are as follows:

**Step 1:** If the 750M is not on while the vehicle is running, turn it on by pressing the **POWER** button.

**Step 2:** Select desired user and press **ENTER** to arrive at the 'Quick Calibration' screen.

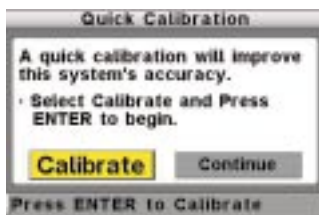

**Step 3:** Highlight 'Calibrate', press **ENTER**.

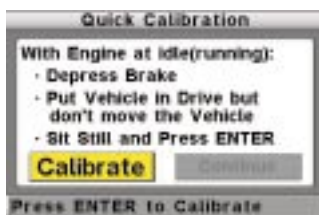

**Step 4:** Follow on-screen instructions.

**Step 5:** Press **VIEW** button.

**Step 6:** Verify that the Direction and Signal Strength Indicator located at the bottom left corner of the Display, is green, indicating that the system has located GPS satellites. If this is not green, refer to the 'Troubleshooting' section.

The 'Quick Calibration' procedure is now complete and the 750M is ready for inputting a destination. For further instructions, consult the 750NAV User Manual.

### Battery Charger

The Battery Charger provides power to the 750M and charges the Battery only during 750M operation. It also incorporates a Battery Test Circuit that allows the user to check the charge on the Battery. Using the 'BATTERY TEST' Button and reading the five (5) multi-colored Battery Status Indicators, a user can determine the state of the Battery, from 'LOW' to '100%'. To determine true Battery power level, either disconnect the Power Adapter or place the Charger switch in 'OFF', otherwise charging voltage will be displayed. Be cautious of leaving the Battery in an automobile exposed to extreme heat or cold. In these situations take the 750M into a home or office when not in use. Extreme temperature may cause the Battery to fail.

Battery charge time varies with age, initial battery power, and temperature and can take up to 12 hours from fully depleted to '100% charge. Operating the 750M does not require the Battery to be at 100%, but operating the 750M with the Battery power level below 'LOW' may prevent automatic backup of destination address and last location information.

To test the Battery simply locate and push the 'BATTERY TEST' Button which is recessed on the bottom of the Battery Charger and read the corresponding Battery Status Indicator.

The Battery Charger has a switch with three selections:

**AUTO:** In the 'AUTO' position, the charger will power the 750M, trickle charge the Battery, and store addresses and last location information during shutdown.

**BATTERY:** In the 'BATTERY' position, no charging occurs. The 'BATTERY' position allows the 750M to be used in a stand-alone mode without the Power Adapter. If the 750M is used in the 'BATTERY' position until the battery power is depleted, address book and last location information may be lost.

**OFF:** In the 'OFF' position, the Battery is not charged when used with the Power Adapter connected to the vehicle's power accessory port, but will allow the 750M to operate. The 'OFF' position is used to shutdown the 750M when in a stand-alone mode, or to check Battery power with the Power Adapter connected and 750M in use.

### Battery Operation / Stand-Alone Mode

The 750M Battery is a lightweight, 12 volt, sealed lead acid type that is pre-charged to be ready for operation. Its sealed construction makes it leak resistant. The Battery has an optimum discharge time of 2 amp hours that should be sufficient to operate the 750M for up to one hour if necessary.



**Battery capacity degrades at low temperatures and over the life of the system.**

In the event that the vehicle power port is unusable, such as a blown fuse, or if required for an airport security check, the 750M can be used solely from a new, fully charged Battery for periods up to 1 hour. To do so, simply slide the Battery Charger switch to 'BATTERY'. Be certain to slide the Battery Charger switch back to 'OFF' or 'AUTO' when finished to avoid depleting the Battery.

### Map Area Switching

The 750M incorporates a feature called 'Auto Map Switching'. When the 750M is transported from one Map Area to another, it will automatically sense the change and then switch to the correct Map Area within several minutes if other Map Areas have been purchased and unlocked. In the event that the 750M needs to be manually switched to a different Map Area, it can be easily done as follows:

**Step 1:** Refer to Map Area illustration on page 27.

**Step 2:** Press **OPTION** to arrive at the 'User Options' screen.

**Step 3:** Scroll to the 'Configuration' icon, press **ENTER**.

**Step 4:** Scroll to 'Map Selection', press **ENTER**.

**Step 5:** Scroll to the desired Map Area and confirm that map is unlocked. If not, call Magellan Customer Service at 1-877-4CARNAV (1-877-422-7628), otherwise, press **ENTER**.

**Step 6:** The 750M will ask "Confirm Map Change". Highlight 'Yes', press **ENTER**.

The 750M will power down to save this change and will restart automatically. Select desired user and continue enjoying the 750M.

### Preparing Navigation Computer for 750NAV In-Vehicle Fixed Installation

After use of 750NAV Navigation Computer in a 750M configuration, the Vehicle Type must be returned to the 750NAV mode. This is done as follows:

**Step 1:** Proceed to the "User Options" Menu, press **OPTION**.

**Step 2:** Scroll to the 'Configuration' icon, press **ENTER**.

**Step 3:** Scroll to 'Vehicle Select', press **ENTER**.

**Step 4:** Scroll to and highlight 'System' and choose 750NAV by pressing **ENTER**.

**Step 5:** Scroll to and highlight, 'Save', press **ENTER**.

**Step 6:** Shutdown, press **POWER**.

The Navigation Computer is ready for return to the 750NAV In-Vehicle Fixed Installation.

## STORAGE

The 750M will automatically shutdown when the vehicle ignition is turned to off. If the 750M needs to be removed while the vehicle is still running, simply press the **POWER** button to shutdown the system manually. Return the Display, Power Adapter, and GPS Antenna to the Carry Case. Store the GPS Antenna on the Antenna Storage Spool by winding the Antenna Wire around the Antenna Storage Spool and placing the GPS Antenna on the Antenna Storage Spool top where it is magnetically retained.



***Avoid tangling, kinking, or excessive twisting of the GPS Antenna Wire when winding or unwinding from the Antenna Storage Spool. While unwinding and routing the Antenna Wire, inspect it for damage. If the Antenna Wire shows signs of extreme kinking or insulation damage, call Magellan Customer Service department for replacement parts at 1-877-4CARNAV (1-877-422-7628).***

Be certain that the Battery Charger switch is in either the 'AUTO' or the 'OFF' position when the 750M will not be in use. Failure to do so will drain the Battery and pre-empt use in the Stand-Alone Mode.

When the 750M will not be used for extended periods, remove the Battery and store in upright, dry, dimly lit location.

## TROUBLESHOOTING

Problem	Possible Cause(s)	Solution(s)
GPS will not initialize within several minutes or GPS Signal Indicator did not turn green.	<ol style="list-style-type: none"> <li>1. Insufficient GPS signal strength due to nearby obstructions.</li>   <li>2. GPS Antenna not connected to Docking Station.</li>   <li>3. GPS Antenna wire is damaged.</li>   <li>4. GPS satellite data is old.</li> </ol>	<ol style="list-style-type: none"> <li>1.               <ol style="list-style-type: none"> <li>a) Move to open area away from trees or tall buildings.</li> <li>b) Ensure GPS Antenna is on exterior of vehicle and not obstructed by roof racks or antennas.</li> </ol> </li>   <li>2. Connect GPS Antenna to Docking Station.</li>   <li>3. Inspect GPS Antenna Wire and connector for damage, and if necessary call Magellan Customer Service at 1-877-4CARNAV (1-877-422-7628) for replacement.</li>   <li>4. Wait 12 – 24 minutes to receive new data and then verify that the Direction and Signal Strength Indicator is green.</li> </ol>
Push-Buttons will not react.	Systems needs to be reset.	Push Power Button and hold for 15 seconds .
Display stays on when vehicle ignition is turned off.	Switch on Battery Charger is in BATTERY position.	Slide switch on Battery Charger to AUTO position.
Temporary map expired.	Database has not been registered and unlocked.	Register the 750M and obtain an unlock code by calling 1-877-4CARNAV (1-877-422-7628).

Problem	Possible Cause(s)	Solution(s)
Display does not turn on.	<ol style="list-style-type: none"> <li data-bbox="397 151 660 175">1. No power to the system.</li> <li data-bbox="397 756 660 808">2. Power to the 750M is turned off.</li> <li data-bbox="397 850 660 875">3. Display is not connected.</li> <li data-bbox="397 946 660 998">4. Vehicle is not running.</li> <li data-bbox="397 1073 660 1125">5. Brightness/Contrast control turned down.</li> <li data-bbox="397 1232 660 1284">6. Carry Case is placed upside down.</li> </ol>	<ol style="list-style-type: none"> <li data-bbox="688 151 958 716">1. <ol style="list-style-type: none"> <li data-bbox="717 151 958 269">a) Verify all connections to the Docking Station, Battery Charger, and Battery.</li> <li data-bbox="717 277 958 367">b) Ensure fuse for the vehicle's Accessory Power Port is good.</li> <li data-bbox="717 375 958 464">c) Turn switch on Battery Charger to 'AUTO' position.</li> <li data-bbox="717 472 958 716">d) Ensure fuse for 750M Power Adapter is good by unscrewing endcap on Power Adapter and removing fuse. Replace with 3 amp miniature barrel fuse.</li> </ol> </li> <li data-bbox="688 756 958 813">2. Push <b>POWER</b> button on the 750M Display.</li> <li data-bbox="688 850 958 907">3. Verify Display Cable is plugged in properly.</li> <li data-bbox="688 946 958 1036">4. Vehicle must be running to power up system; start vehicle.</li> <li data-bbox="688 1073 958 1192">5. Turn up Brightness/Contrast thumb wheel control on Display.</li> <li data-bbox="688 1232 958 1289">6. Turn Carry Case so that Air Vent side is up.</li> </ol>

Problem	Possible Cause(s)	Solution(s)
Will not save last position.	<ol style="list-style-type: none"> <li>1. Battery or Battery Charger is not properly connected.</li> <li>2. Back-up Battery has no power</li> </ol>	<ol style="list-style-type: none"> <li>1. Verify all connections to Battery and Battery Charger</li> <li>2. Check Battery voltage by pressing button on side of the Battery Charger. If indicator reads low after charging, replace battery.</li> </ol>
No roads are displayed.	<ol style="list-style-type: none"> <li>1. Incorrect map area has been selected or Automatic Map switching has not occurred.</li> <li>2. Map view scale is too large.</li> <li>3. Map Area not purchased.</li> <li>4. Vehicle is in an area where the road or street data is not contained in the 750M map database.</li> <li>5. User has panned to an area where there are no roads.</li> </ol>	<ol style="list-style-type: none"> <li>1. a) Refer to Map Area illustration on page 27 and manually select the proper map b) If unsure of correct map selection, call customer service at 1-877-4CARNAV (1-877-422-7628).</li> <li>2. Press the zoom key ' - ' to change the Map scale.</li> <li>3. Purchase desired Map Area by calling 1-877-4CARNAV (1-877-422-7628)</li> <li>4. Not every city in the U.S. and Canada is included in the 750M map database. Magellan continues to add new cities, streets, and roads. Check availability and schedule for new Map Area coverage by calling Magellan Customer Service 1-877-4CARNAV (1-877-422-7628).</li> <li>5. Press CANCEL to return the vehicle icon to the correct location.</li> </ol>



Problem	Possible Cause(s)	Solution(s)
<p>Poor vehicle positioning performance.</p>	<ol style="list-style-type: none"> <li>1. GPS Antenna is not connected.</li> <li>2. GPS Antenna is incorrectly located.</li> <li>3. Carry Case is not placed in same orientation.</li> <li>4. Carry Case has shifted from its calibrated position due to a sudden stop, acceleration or turn.</li> <li>5. Improper calibration process due to steep grade or excessive acceleration.</li> </ol>	<ol style="list-style-type: none"> <li>1. Connect GPS Antenna to Docking Station.</li> <li>2. GPS Antenna needs an unobstructed view of the sky from the exterior of the vehicle. Ensure luggage racks or accessories are not blocking the satellite signal to the GPS Antenna.</li> <li>3. Place the bag in its original orientation.</li> <li>4. Eliminate possible movement of Carry Case.</li> <li>5. Conduct Full Calibration.</li> </ol>
<p>Bias or Orientation Learn Count will not increment.</p>	<ol style="list-style-type: none"> <li>1. Acceleration rate is too severe for 750m to accept.</li> <li>2. Bias and Orientation Learn Counts are at upper count limit.</li> <li>3. Calibration is being conducted on terrain with too much incline.</li> </ol>	<ol style="list-style-type: none"> <li>1. Accelerate moderately.</li> <li>2. The 750m is designed to have count limits of 20 and 50. This does not necessarily indicate a malfunction. Continue normal operation.</li> <li>3. Conduct calibration on terrain that is as level as possible, less than 2% grade.</li> </ol>

## 750M CARE & MAINTENANCE

Designed to provide years of trouble-free use, the Magellan 750M system requires little or no maintenance. As with all electronic equipment, care should be taken to avoid system damage. Following the suggestions below will ensure maximum functionality and enjoyment of the 750M.

- Most common multi-purpose cleaners will not harm the Display or Navigation Computer unit. DO NOT spray cleaner directly onto the Display; apply cleaner to a cloth first and then wipe the Display with dampened cloth. Harsh chemicals such as those found in hair spray, insect repellent and nail polish can damage the Display lens. Do not spray or use these near the Display.
- Refrain from getting any part of the 750M wet with water or any other liquid.
- The system is designed to be rugged, but can be damaged if dropped. Use caution when removing and transferring the system from one location to another.
- Do not expose the 750M system to extreme heat or cold temperatures for extensive periods of time.
- Roads, addresses, business, and service locations change from time to time. The 750M can be updated with the latest road and Points of Interest data. Visit a local dealer or call toll-free 1-877-4CARNV (1-877-422-7628) for product information upgrades.

## 750M REPLACEMENT PARTS

- Antenna Storage Spool
- Battery
- Battery Cable
- Battery Charger
- Carry Case
- Carry Case Shoulder Strap
- Display
- Docking Station
- GPS Antenna
- Navigation Computer
- Power Adapter
- Quick Mount Bracket

## BATTERY REPLACEMENT & DISPOSAL

### Replacement

Replace the Battery when:

1. Charge or discharge characteristics of the Battery change.
2. The Battery no longer holds a charge as indicated by the Battery Status Indicator consistently showing 'LOW' after charging.
3. Any time there is an indication of Battery leakage.
4. The Battery case is deformed or cracked.

When the original Battery included with the 750M system needs to be replaced, be sure to contact Magellan to purchase a replacement. Only use batteries and chargers approved by Magellan, otherwise the warranty may be voided. To purchase a new Battery or Battery Charger contact the Magellan Customer Service department at 1-877-4CARNAV (1-877-422-7628).

### Disposal

The proper disposal of 750M system Battery is critical, both from the viewpoint of environmental stewardship and from compliance with federal and state environmental laws. The owner of the 750M is responsible for the proper disposal of the Battery included with the system as well as all replacement batteries purchased.

The 750M system Battery is a sealed lead acid type. It is chemically identical to common automotive starter batteries and must be recycled. To recycle the 750M system Battery, please take it to any site that accepts automotive lead acid batteries for recycling. Examples include retailers of automotive batteries, automotive service centers, scrap metal dealers, etc.



**Magellan 750m Map Areas**

**W**elcome to the Magellan 750<sub>M</sub> portable vehicle navigation and information system. The 750<sub>M</sub> provides 750<sub>NAV</sub> functionality without the need for permanent installation. Pre-assembled in a convenient Carry Case, the 750<sub>M</sub> offers on-the-go vehicle navigation and information. The included Power Adapter, Battery and Battery Charger provide system power. Simply attach the Battery to the system, plug the system into the Accessory Power Port, place the Antenna on the roof, and go!





2950 Waterview  
Rochester Hills, MI 48309  
Toll Free Number: 1-877-4 CAR NAV  
[www.magellangps.com](http://www.magellangps.com)

## Free Manuals Download Website

<http://myh66.com>

<http://usermanuals.us>

<http://www.somanuals.com>

<http://www.4manuals.cc>

<http://www.manual-lib.com>

<http://www.404manual.com>

<http://www.luxmanual.com>

<http://aubethermostatmanual.com>

Golf course search by state

<http://golfingnear.com>

Email search by domain

<http://emailbydomain.com>

Auto manuals search

<http://auto.somanuals.com>

TV manuals search

<http://tv.somanuals.com>