

MAGELLAN

GPS 4000 XL Satellite Navigator

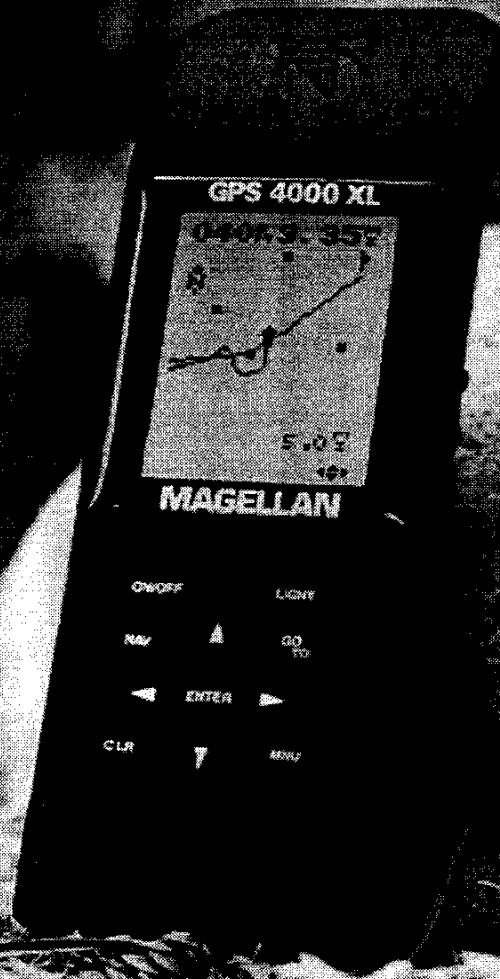

User Manual

Cur



WARNINGS

USE GOOD JUDGEMENT

This product is an excellent navigation aid, but does not replace the need for careful orienteering and good judgement. Never rely solely on one device for navigating.

USE CARE

The Global Positioning System (GPS) is operated by the U.S. Government, which is solely responsible for the accuracy and maintenance of GPS. The accuracy of position fixes can be affected by the periodic adjustments to GPS satellites made by the U.S. Government and is subject to change in accordance with the Department of Defense civil GPS user policy and the Federal Radionavigation Plan.

USE CAUTION

Accuracy can also be affected by poor satellite geometry. When the accuracy warnings appear on the screen, use the data with extreme caution.

USE PROPER ACCESSORIES

Use only Magellan cables and antennas; the use of non-Magellan cables and antennas may severely degrade performance or damage the receiver, and will void the warranty.



LICENSE AGREEMENT



Magellan grants you, the purchaser, the right to use the software supplied in and with MAGELLAN GPS products (the "SOFTWARE") in the normal operation of the equipment. You may make copies only for your own personal use and for use within your organization.

The SOFTWARE is the property of MAGELLAN and/or its suppliers and is protected by United States copyright laws and international treaty provisions; therefore, you must treat this SOFTWARE like any other copyright material.

You may not use, copy, modify, reverse engineer or transfer this SOFTWARE except as expressly provided in this license. All rights not expressly granted are reserved by MAGELLAN and/or its suppliers.

* * *

© 1996 by Magellan Systems Corporation. All rights reserved.

No part of this User Guide may be reproduced or transmitted in any form or by any means, electronic or mechanical, including photocopying and recording, for any purpose other than the purchaser's personal use without the written permission of Magellan Systems Corporation.

Magellan™, GPS 4000 XL™ are the trademarks of Magellan Systems Corporation.

Part No. 22-60093-000

CVF
2



 **MAGELLAN**
SYSTEMS CORPORATION
960 Overland Court
San Dimas, California 91773 USA
(909) 394-5000

22-60093-000



*CVR
4*

GPS 4000 XL Field Reference Card

Battery Installation:
Install four AA alkaline batteries as shown.

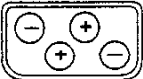

Bottom View

NOTE: When instructed to: Select ITEM

Highlight the menu item and press **ENTER**.

Turning the Receiver On:
ON/OFF Press and hold until **COPYRIGHT** is displayed

Setting Contrast:
From any NAV Screen **ENTER** Select **CONTRAST**

Adjust the **CONTRAST** **ENTER**

Viewing SAT STATUS Screen:
MNU Select **SAT STATUS**

Saving a Position as a Landmark:
From any NAV Screen **ENTER** Select **SAVE POS**

Choose one

Enter LMK Name **ENTER**

ENTER Receiver-generated name

Creating a Landmark:
From any NAV Screen **ENTER** Select **CREATE LMK**

Enter LMK name, latitude, longitude, and elevation

Viewing a Landmark:
MNU Select **LMK MENU** Select **Landmark**

Clearing a Landmark:
MNU Select **LMK MENU** Select **Landmark**

ENTER Select **DELETE LMK** Confirm **DELETE**

Activating a GOTO:
GOTO Select **Landmark**

Accessing the Route Menu:
MNU Select **ROUTE MENU**

- or -
From any NAV Screen **ENTER** Select **ROUTE MENU**

Creating a Route:
From Route Menu Select **EMPTY Route*** Select **"FROM" LMK**

Select **"TO" LMK** Repeat for each leg (20 max) **ENTER**

* if no empty route, a route must be deleted

Reversing a Route:
From Route Menu Select **Route** **ENTER** Select **REVERSE**

Creating a Backtrack:
GOTO Select **BCKTRK**

SETUP: (Defaults in bold)

Coordinate System	LAT/LON UTM, OSGB, Irish, Swiss, Finnish Swedish, User
Elevation Mode	2D, 3D
Time Display	LOCAL AM/PM LOCAL 24 HR UT
Speed Units	KNOTS, MPH, KPH
Distance Units	NAUT MILES ST MILES, KM
Elevation Units	FEET, METERS
North Reference	MAG, TRUE
Map Datum	WGS84, Other...
LMK Sort	ALPHABETIC, NEAREST
Plot Setup	Track Up 0.5 DIST
NMEA	OFF 0183A B C
Baud Rate	4800, Other
Map Scale	1:024,000 Inches, CM

MAGELLAN
SYSTEMS CORPORATION
960 Overland Ct., San Dimas, CA 91773
(909) 394-5000

22-60101-000



Contents

Introduction

Welcome to the GPS 4000 XL	1
Packing List	1
Conventions Used in this Manual	1

Getting Started

GPS 4000 XL Description	3
Installing the Batteries	4
First Time Use	4
Initializing the Receiver	5
Proper Handling - Signal Reception	9
Taking your First Position Fix	10
Saving Your Position as a Landmark	10
Saving a Landmark with Different Coordinates	11
Introduction to Routes	11
Creating a GO TO	12
Navigating with the GPS 4000 XL	12

Reference

Powering the GPS 4000 XL	13
Inputting Data	14
Turning the Display Light On/Off	14
Contrast	15
Using the GPS 4000 XL NAV Screens	16
Viewing the NAV Screens	16
1ST and 2ND POSITION Screens	17
NAV 1 Screen	17
NAV 2 Screen	18
Customizing the NAV Screens	19
POINTER screen	20
PLOTTER screen	21
Deleting Plotter Track	22

Accessing the PAN N SCAN Functions	22
Creating a Landmark From PAN N SCAN	23
Creating a GO TO Route in PAN N SCAN	23
Viewing a LMK Message in PAN N SCAN	23
Creating a GO TO COORD	24
ROAD Screen	24
Viewing Destination Landmark Messages	25
The Bell Icon Alert	25
Working with Landmarks	26
Saving a Position as a Landmark	26
Attaching a Message to a Landmark	27
Creating a Landmark with User-Entered Coordinates	28
Viewing a Stored Landmark	30
Viewing a Landmark Message	31
Editing a Landmark Message	31
Deleting a Landmark Message	31
Projecting a Landmark	
From the Position Screen	32
From an Existing Landmark	32
Landmark Projection	33
Triangulation	33
Map Projection	34
Editing a Landmark	35
Deleting a Landmark	36
Using the LAST FIX Buffer	37
Viewing the Last Fix Buffer	37
Copying a Last Fix as a Landmark	37
Deleting a Last Fix	38
Working With Routes	39
GO TO (Activating)	39
Creating a Coordinate GO TO Route	39
Creating a Backtrack Route	39
Accessing the Route Menu	40
Creating a Route	40
Deactivating a Route	42
Activating a Route	42
Reversing a Route	43

Editing a Route	43
Adding a Leg to the End of a Route	44
Inserting a Leg in a Route	44
Deleting a Leg from a Route	45
Replacing a Landmark in a Route	45
Viewing a Leg in a Route	46
Activating a Leg of a Route	47
Deleting a Route	47
Using the SUN/MOON Screen	48
Accessing the SUN/MOON screen	48
Tracking with the Trip Odometer	48
Accessing the Trip Odometer Screen	48
Resetting the Odometer	49
Resetting the Trip Odometer	49
Clearing Memory with CLEAR MENU	50
Clearing All Last Fixes	50
Clearing Plotter Track	50
Clearing All Landmarks and Routes	50
Clearing All Memory	51
Customizing the GPS 4000 XL	51
Initializing	51
Selecting a Coordinate System	52
Selecting the Elevation Mode	52
Selecting Time Display and Changing the Time	53
Selecting Speed Units	54
Selecting Distance Units	54
Selecting Elevation Units	54
Selecting the North Reference	55
Selecting a Map Datum	55
Selecting NMEA Format	56
Selecting the Baud Rate	56
Activating or Deactivating the 2ND POS Screen	57
Changing the Landmark Sorting Order	57
Setting the Plotter Orientation	57
Setting Map Scale and Measurement Units	58
Setting Plotter Track History	58
Adjusting Screen Contrast	58



Using the Map Distance Tool	59
Viewing the Status of Available Satellites	59
Simulating Navigation with the GPS 4000 XL	60
<i>Icons</i>	<i>62</i>
<i>Warnings and Other Messages</i>	<i>63</i>
<i>Troubleshooting</i>	<i>64</i>
Possible Problems and Corrective Steps	64
Contacting Customer Service	65
<i>Connecting External Power/Device</i>	<i>67</i>
<i>Connecting to an External Antenna</i>	<i>68</i>
<i>Upload/Download Landmark Data</i>	<i>69</i>
<i>Swivel Mounting Bracket</i>	<i>70</i>
<i>NMEA Data Messages</i>	<i>72</i>
<i>Listing of Available Datums</i>	<i>77</i>
<i>Specifications</i>	<i>78</i>
<i>Coordinate Systems</i>	<i>79</i>
<i>What is GPS?</i>	<i>83</i>
<i>Where to Get More Information on GPS</i>	<i>85</i>
<i>Abbreviations</i>	<i>87</i>
<i>City Reference Chart</i>	<i>88</i>
<i>Glossary</i>	<i>93</i>
<i>Index</i>	<i>95</i>





Introduction

Welcome to the GPS 4000 XL

Congratulations on your purchase of the Magellan GPS 4000 XL satellite navigator. The GPS 4000 XL represents the latest technical innovation from the world's foremost GPS receiver manufacturer. Since introducing the world's very first commercial, hand-held GPS receiver in 1989, Magellan has led the way with innovative GPS products to meet a wide range of positioning and navigation needs.

Designed specifically for outdoor sports recreation, the GPS 4000 XL is ideal for hiking in the backcountry, mapping fishing hot spots, marking trails, or just finding your way around in the Great Outdoors. Magellan has established a reputation for product excellence and customer support. Our customers include sailors, commercial fishermen, pilots, geologists, explorers, surveyors and the Allied Forces in Desert Storm.

To help you get started using your new Magellan GPS 4000 XL, turn to the section titled "Getting Started." This quick-start session will have you recording landmark locations and navigating in no time at all. After you've learned the basics, the rest of this manual will give you detailed information about all of the features and functions of your GPS 4000 XL satellite navigator. A Reference Section, Troubleshooting, and Appendix with Glossary are included as well.

Packing List

Before you begin, make sure that your package includes the items listed on the GPS 4000 XL box. If any items are missing or damaged, contact Magellan customer service immediately at (909) 394-5000.

Optional accessories are available from Magellan Systems or your local dealer for your GPS 4000 XL Satellite Navigator.

Conventions Used in this Manual

The reference section of this manual is designed to assist you in the use of your Magellan GPS 4000 XL. Each topic in the reference section includes a brief description of the activity chosen, a pictorial view of the keys to press, and a detailed description with sample screens of how to perform the activity. As you become more familiar with your receiver, you will be able to use the pictorial view of the keys as a "quick reference" to perform the desired activity. When you are instructed to "select" an item from a list you need to highlight the item and press ENTER.



In the reference section you will be given instructions to follow. **Bolded** words indicate the key or keys to be pressed; *italics* indicate the name of the screen to be viewed; and ALL CAPS indicate a menu item to be selected.

Also in the reference section are alerts to inform you of some cautions or notes that will assist you in using your Magellan GPS 4000 XL.



The stop sign indicates the information enclosed is very important and should be read before moving on.



The Magellan logo denotes information that can help you use or understand your receiver. While this information is not required to perform the activity, it may provide you with a better understanding of the activity or shortcuts you can use.

Getting Started

This section will show you how to begin using your GPS 4000 XL for the first time. You will learn how to:

- Install the batteries
- Initialize the receiver
- Get a position fix
- Save your first landmark
- Create a GO TO
- Begin navigating

GPS 4000 XL Description

The GPS 4000 XL is a self-contained hand-held GPS receiver designed for general purpose position locating and navigation. It has a built-in antenna located at the top of the receiver, a high-contrast backlit LCD, and keypad. Using four AA batteries, inserted from the battery door found at the base of the receiver, the GPS 4000 XL will operate continuously for up to 24 hours.

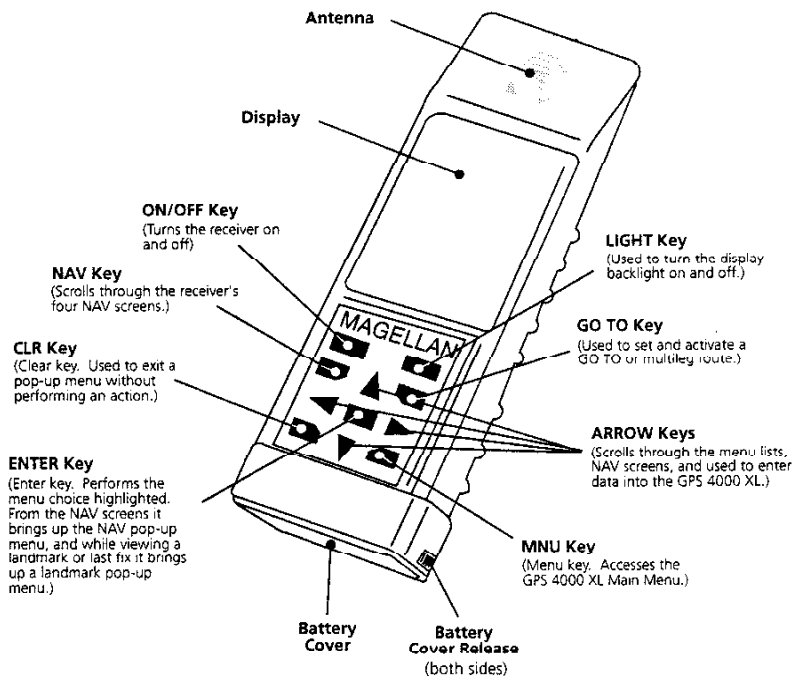

Receiver Accuracy. The satellite constellation that provides the GPS information your receiver uses is maintained by the Department of Defense (DoD) for use by the U.S. armed forces and its allies. GPS positioning for general use provides 25 meter RMS accuracy or better. Since the signals generated by these

satellites are publicly accessible, the DoD has introduced errors into the satellite signals for security reasons. These errors are referred to as Selective Availability (SA).

At present, your GPS position will be accurate to within 100 meters horizontally and 150 meters vertically. Your horizontal coordinates may be slightly more than 100 meters from your actual position about 5% of the time, due to the errors introduced by Selective Availability. Elevation may vary even more.

Installing the Batteries

The GPS 4000 XL uses four AA alkaline batteries that are installed from the bottom of the receiver. To remove the battery cover, hold the receiver in one hand and with the other hand press in the two battery cover release tabs found on each side of the receiver. With the tabs pressed in, the battery cover can now be removed. When inserting or removing the battery cover you will notice some resistance. This is because the battery cover contains a rubber gasket to seal the battery compartment from water and dirt.

Insert the batteries as shown below and replace the battery cover. Make sure that the rubber gasket is seated correctly in the groove.

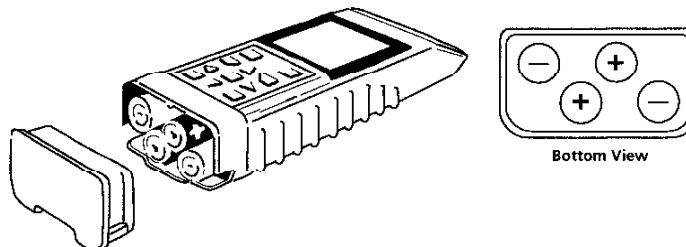

The receiver's memory will remain intact for up to 20 minutes when the batteries are removed. This allows you to change the batteries without losing the receiver's memory. If batteries are left out of the unit for more than 20 minutes, memory such as stored landmarks and satellite data will be lost and the unit will need to be reinitialized.

First Time Use

The constellation of 24 GPS satellites circling the globe is in constant motion and before your receiver can tell you where you are, it needs to know where the satellites are relative to itself. It does this with the use of an internal almanac where it has stored in memory a general location and a time and date. The almanac tells the receiver which satellites are in view, based on the time and location of the receiver.



The problem is that until it is initialized, the receiver doesn't know its approximate location, so it doesn't have a reference point in selecting which satellites to use. Without knowing its approximate location, the receiver may take 15 minutes or more to find your current position. Telling your receiver the initial position, time and date is called *initializing* your receiver; initializing enables it to begin tracking satellites, and therefore, calculating your position, much faster.

Initializing the Receiver

You do not need to initialize your receiver each time you use it. Follow these steps to initialize the GPS 4000 XL if this is the first time you are using it, if the receiver memory has been cleared or if the receiver has been transported more than 300 miles while turned off. In the latter case, you are not automatically prompted by the receiver to reinitialize and the *POSITION* screen is displayed instead of the initialization warning after the start-up screens. The *POSITION* screen tells you the coordinates of the last position received. These coordinates are not necessarily those of your current position.

Inputting Approximate Position. To give your receiver an approximate idea of its current location, you will need to enter the approximate latitude, longitude, date, and time of where you are now.

Since you may not know the latitude and longitude coordinates of your present position, the GPS 4000 XL provides you with a world map and list of geographic regions in the receiver's Initialize function under Setup. This allows you to choose the general area of the world you are in, and the specific country or province of your current position. Selecting the appropriate location from the list will give your receiver a starting point for tracking satellites. This will greatly shorten the time it will take the receiver to get your position for the first time (referred to as Time To First Fix).

Turn the receiver on by holding down the ON/OFF key until the start-up screens appear.

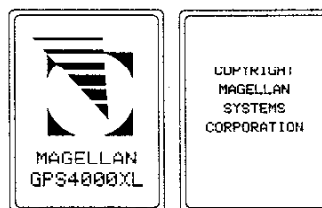

If the receiver has not been initialized previously, or if the receiver's total memory has been cleared, you will see the following screen, prompting you to press **ENTER** to initialize.

Press **ENTER** to Initialize.

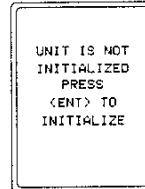

If you choose to press **NAV** to continue without initializing manually, the receiver displays the *POSITION* screen with null values for the latitude and longitude (00°00.00N, 000°00.00W). In this case, the receiver will self-initialize, which may take 15 minutes or more. We recommend initializing manually to allow the receiver to get a position fix sooner.

The world map screen appears with a list of locations around the globe. This list extends to a second page which can be viewed using the **UP/DOWN ARROWS**. Highlight the general area of the world where you are located and press **ENTER**.



A list of countries, provinces or states within that general area appears. Use the **UP/DOWN ARROWS** to select the country, province or state of your location and press **ENTER**.



The receiver displays the Initialize page with the highlight active in the elevation field. Use the **LEFT/RIGHT** and **UP/DOWN ARROWS** to enter your present elevation if you know it, and press **ENTER**. If you do not know your elevation, press **ENTER**.

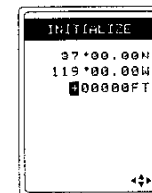

If this is not the first time you have used your receiver, or if it is the first time but your receiver has already begun acquiring satellite signals, the following time and date entry may not be displayed.

Input your local time. Take extra care to input the time correctly (to within 10 minutes), including the AM/PM designator. Use the **ARROW KEYS** to change the time. Use the **UP/DOWN ARROWS** to change "AM" to "PM" if necessary. When the time is correct, press **ENTER**.

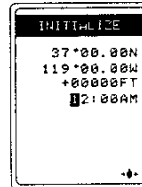

Please note that if you are located in a half-hour time zone, you will need to manually reset the time, after the receiver has taken a position fix, by adding or subtracting one half hour. Please refer to Customizing - Time Display for directions on resetting time.

Your receiver requires just one more piece of information and that is the date. Use the **UP/DOWN ARROWS** and **RIGHT/LEFT ARROWS** to set the correct date. Your display should resemble the one shown at right. Double-check all of the information entered. Then, press **ENTER**.

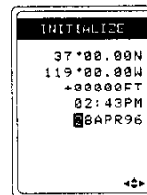

If you notice that you made a mistake, press **MNU**, highlight **SETUP MENU**, press **ENTER**. Select **INITIALIZE**, press **ENTER** and start over.

Initializing With Known Coordinates

If you know your present latitude and longitude, you may enter them directly (instead of choosing a geographic location from the list). In this case, highlight **ENTER COORD** and press **ENTER**. The City Reference Chart, found in the appendix, provides coordinates of many major cities.



Press the **UP ARROW**. Notice that the highlighted number has incremented by one. Keep pressing the **UP ARROW** until the first digit matches the first number you found for latitude. If you go past the number you want, you can use the **DOWN ARROW** to step down or continue using the **UP ARROW** and loop through the number sequence.



When the correct number is displayed, press the **RIGHT ARROW** to step to the second digit on the latitude line.

What's important to remember here is that the **UP/DOWN ARROW**s step up or down through the numbers and the **RIGHT/LEFT ARROW**s move the highlight to the right or left.

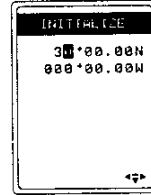

Continue entering the latitude. Use the **RIGHT ARROW** to highlight the "N" at the end of the latitude line. Latitude may be north "N" or south "S" and may be changed, if necessary, by using the **UP/DOWN ARROW**. Once the latitude is correct, press **ENTER**.

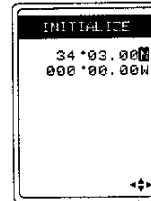

The cursor (highlighted area) has now jumped down to the first character on the longitude line. Following the same procedure as before, enter the longitude and "E" or "W".

Your display should now resemble the one shown to the right with your latitude and longitude. If all of the information for the latitude and longitude is correct, press **ENTER**. (If you notice now that you made a mistake in the latitude or longitude, press **MNU**, highlight **SETUP MENU** and press **ENTER**. Select **INITIALIZE**, press **ENTER** to start over.)

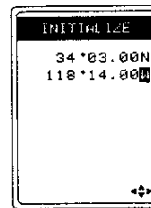

The receiver will prompt you for your local elevation, time and date. Use the **UP/DOWN** and **RIGHT/LEFT ARROW**s to enter these as described above; press **ENTER** to confirm each screen.

The receiver is now ready to perform one of its primary functions, providing you with your current position.

Proper Handling - Signal Reception

Since the GPS 4000 XL receives information it needs from satellites orbiting the earth, the antenna needs to have a relatively unobstructed view of the sky.

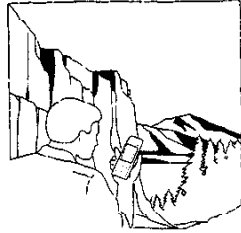

Blocked or Partially Blocked View of the Sky. The cliffs to the left may block the satellite signal. Physical obstructions will block satellite signals from reaching the receiver. If unable to get a position fix, move the receiver so it has a clearer view of the sky.

Clear View of the Sky. The receiver has a clear view of the sky in all directions allowing it to choose from all of the satellites currently available.

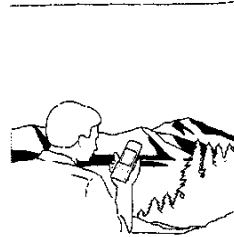

If the view of the sky is poor (large cliffs or buildings on both sides, heavy foliage, or other obstructions) the satellite signals can be blocked and the GPS 4000 XL may take longer to compute a position fix.

Holding the Receiver. The GPS 4000 XL is designed to fit comfortably in your hand. Hold the receiver with the antenna above your hand and the flat portion of the antenna towards the sky.

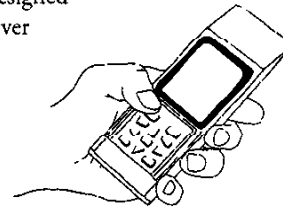

Do **not** place metallic decals or labels over the antenna portion of the receiver. Drastic reductions in signal levels can occur. This can dramatically decrease the GPS 4000 XL's signal reception.

Taking Your First Position Fix

To get a position fix, you must be outside with a clear view of the sky and away from any large obstructions (buildings, large trees, etc.).

If the receiver is off, press the **ON/OFF** key to turn the receiver on, or if you have just finished initializing the receiver, press the **NAV** key until the screen showing your coordinates is displayed. This screen is called the *POSITION* screen.

The *POSITION* screen appears with the latitude, longitude, and elevation that you entered during *INITIALIZE*. The word "SEARCHING" appears indicating that the receiver is searching the sky for satellites.

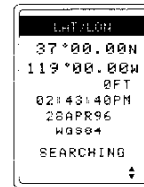

In a short period of time, the receiver will locate the satellites and begin receiving information. The first indication of this is that "SEARCHING" is replaced with a bar graph indicating the receiver's progress toward acquiring GPS data from the satellites.

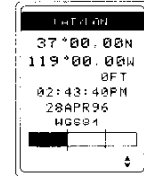

Within a few minutes, the bar graph will disappear and be replaced with the local time. This indicates that your receiver is receiving GPS information and has computed your present position. Everything that you do from now on is based on the position information received.

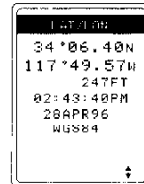

The position fix updates as you change location. As long as the batteries are good, the most recent position fix will be retained by the receiver's memory, even while the receiver is turned off, until you either clear the memory or reinitialize.

Saving Your Position as a Landmark

You now have a position fix that defines your current position. You can save this position in the receiver's memory and navigate back to it later.

From the Position screen, or any NAV page, press **ENTER, ENTER, ENTER, ENTER**. You will see a predefined "name" for this landmark flash briefly above the coordinates. You could have entered a name of your own using the **ARROW** keys after the second **ENTER**. The procedure for entering a name is better defined with *Saving a Position as a Landmark* in the Reference Section.

The display returns to the position screen.



You have now stored this position in memory. It's that easy. Until you clear the landmark or the receiver's memory, that landmark will be there for you to use. No matter where in the world you go, as long as you can take position fixes, your GPS 4000 XL can guide you back to this spot.

Saving a Landmark with Different Coordinates

You can also create a new landmark with coordinates that differ from your current position. For example, let's practice by entering a landmark for Magellan Systems Corporation in San Dimas, California.

From the *POSITION* screen press **ENTER**, then press the **DOWN ARROW** to highlight **CREATE LMK**, and press **ENTER** again.

This looks identical to the screen you saw when you were saving your position as a landmark. This function differs in that it allows you to change the coordinates and elevation of the landmark.

Using the **RIGHT/LEFT ARROWs** and the **UP/DOWN ARROWs** you can assign a name to this landmark following the same principles you used in initializing the receiver. Key in the name **MAGELN** for this landmark. When you have finished, press **ENTER**. Note that you could have named this landmark anything you wanted (up to 6 characters). Enter the latitude ($34^{\circ}06.58N$) and the longitude ($117^{\circ}49.58W$) for Magellan, confirming each line with **ENTER**.

Enter 922 feet for the elevation and press **ENTER**. Press **ENTER** again confirming that you do not want to add a message. The display returns to the position screen. A landmark named "MAGELN" has now been placed into memory and is ready for you to use.

Introduction to Routes

A route is a planned course of travel defined by a series of landmarks. To create a route, you select landmarks that you have stored in the receiver's memory. These landmarks are then connected to form the segments or "legs" of the route. A route may contain from one to twenty legs and you may store up to 5 routes.

Suppose you were on a fishing trip in the area shown. You want to go from the camp site to the island in the middle of the bay.

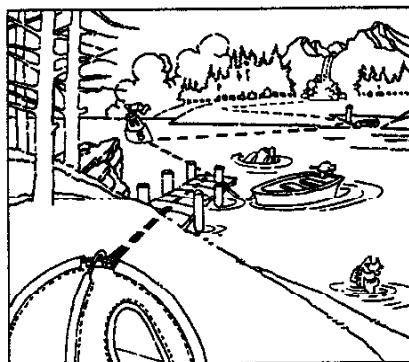

Before you start, turn the receiver on and let it get a position fix. Once you have a fix, save it as a landmark. That way you'll be able to create a route back to the camp at the end of the day, even if darkness or weather conditions (cloud cover, rain, etc.) make it difficult to use your own navigation skills.

In addition, you can instantly create a one-leg route called a GO TO. A GO TO route uses your present position as its start and any landmark you select from memory as the destination.



If the receiver has not yet computed a position fix, then the start of the GO TO may not represent your current position. It will, however, correct the navigation information after a position fix is acquired.

Creating a GO TO

A GO TO is the direct line from your current position to any landmark you have in memory. For this example, you will create a GO TO from your current position to Magellan Systems.

Press **GO TO**. Landmarks appear in two columns of eight landmarks per column (once you have created a sufficient number of them) and the first three options are ROUTE, BCKTRK and COORD. The ROUTE option is highlighted. The rest of the list consists of landmarks in alphabetical order. Use the **DOWN ARROW** to highlight the landmark MAGELN.

Press **ENTER**. You have now created a GO TO route to the landmark named MAGELN. Your GPS 4000 XL returns to the last NAV screen viewed and immediately begins computing the information you need to get to Magellan, no matter where you are.



It is necessary to have a current position fix in order for the receiver to compute navigation information. If you do not have a position fix, the navigation information will be displayed with dashes until a position fix is acquired.

Navigating with the GPS 4000 XL

The GPS 4000 XL has seven different screens that provide you with information that you can use to navigate by.

Press **NAV**, then the **UP/DOWN ARROWS** to cycle through the different screens. As you use your GPS 4000 XL you will probably find that one of the NAV screens is more suitable than the others for your particular needs. *The POSITION 1, NAV 1, NAV2, POINTER, PLOTTER, ROAD* and (if turned on in SETUP) *POSITION 2* screens are constantly updating and contain the information necessary to guide you to your destination.

Reference

Powering the GPS 4000 XL

Turning the Receiver On

Press the ON/OFF key and hold down until the "GPS 4000 XL" screen is displayed (approximately 5 seconds). The MAGELLAN GPS 4000 XL copyright display will quickly flash on the screen and then the *POSITION* screen appears.

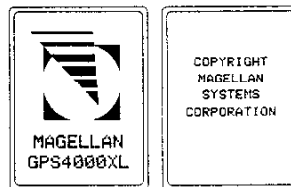

If the receiver has not been initialized previously, or if the receiver's memory has been cleared, you will see the following screen, prompting you to press ENTER to initialize or NAV to continue.

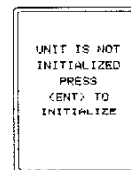

Press ENTER to initialize. The *INITIALIZE* screen appears showing the world map with a 2-page list of general locations around the globe.



If you press NAV to continue without initializing manually, the receiver displays the *POSITION* screen with null values for the latitude and longitude (00°00.00N, 000°00.00W). In this case, the receiver will self-initialize, which can take more than 15 minutes. See *Initializing the Receiver* under Getting Started.

The receiver begins its search for available satellites and displays "SEARCHING" on the screen.

Once the receiver begins receiving signals from a satellite, "SEARCHING" is replaced with a sliding bar that displays the progress of the receiver in acquiring additional satellite signals.



When the receiver is tracking three or more satellites it will compute a position fix. The sliding bar will disappear and the lock icon will close. If initialized, the GPS 4000 XL will get your position fix within 3-5 minutes.

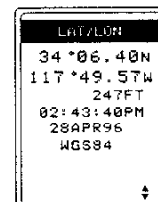



The position may be displayed in LAT/LON, UTM, OSGB, Irish, Swiss, Swedish, Finnish and User Grid coordinates and the time may be displayed in 24-hour, AM/PM local time, or UT (Universal Time or Greenwich Mean Time). These options may be changed in SETUP MENU. Note that in LAT/LON format, you are asked to choose between DEG/MIN.MM, DEG/MIN.MMM and DEG/MIN/SEC. This is because fractions of one minute can be expressed as decimals (hundredths and thousandths) or seconds (there are 60 seconds to one minute of latitude or longitude).

Turning the Receiver Off

ON/OFF

Press the ON/OFF key. The receiver will begin a countdown sequence that will last for 5 seconds. Pressing any key (except ON/OFF) will stop the receiver from turning off. Pressing the ON/OFF key a second time causes the unit to shut off immediately.

Inputting Data



Moves the cursor one space, left or right



Scrolls through the alphanumeric list

The UP/DOWN and RIGHT/LEFT ARROWs have different functions depending on the screen being viewed.

While on some screens the UP/DOWN or RIGHT/LEFT ARROWs are used to access additional pages, on other screens they allow you to input data, such as landmark names or coordinates, to adjust the CDI scale, or to select menu items.

The ARROW ICONS in the status line indicate which arrow keys are currently available for use.

Turning the Display Light On/Off

LIGHT

To activate the display light when the unit is on, press the LIGHT key. To deactivate the display light, press the LIGHT key again.



The GPS 4000 XL will indicate that the light is on with a light bulb (☀) icon at the bottom of the screen next to the arrow icons.



The display light causes an increase in battery drain resulting in shorter battery life.

Contrast

Used to adjust the contrast of the display.

From any
NAV Screen

ENTER

Highlight
CONTRAST
Press **ENTER**

Use **↑/↓** arrows
to adjust display
contrast

From any of the NAV screens, press the **ENTER** key to activate the pop-up menu. Use the **UP/DOWN ARROW** to highlight **CONTRAST**.

Press **ENTER**. A sliding bar graph appears below the word **CONTRAST**. Use the **RIGHT/LEFT ARROW** keys to adjust the screen contrast setting to the desired level.



Press **ENTER** to return to the last viewed NAV screen, or **CLR** to return to the NAV menu.



The contrast adjustment bar can also be accessed from the **SETUP** menu.

Using the GPS 4000 XL NAV Screens

Viewing the NAV Screens

The GPS 4000 XL will display your position and progress towards your destination on seven different navigation screens that can be accessed by pressing the NAV key.

Once you are viewing any NAV screen you can scroll to the next by using the UP or DOWN ARROW. Pressing the NAV key will scroll in the same direction as the DOWN ARROW.

The *1st POSITION* screen displays the coordinates of your current location, which you can compare to a map. It also displays the date, time, and datum. You can select the coordinate system of your choice under SETUP.

The *NAV 1*, *NAV 2*, and *POINTER* screens display information that will help you arrive at your destination.

The *PLOTTER* screen displays a graphical representation of your travels relative to your planned route.

The *ROAD* screen displays a graphical representation of cross track error and a Course Deviation Indicator.

A *2nd POSITION* screen (not shown) is available when turned on using the SETUP menu. This screen is identical to the *1st POSITION* screen shown at the top of the flow chart. This screen is used to display the current position in a coordinate system different from the one being used for the *1st POSITION* screen. When turned on, it appears below the road screen.

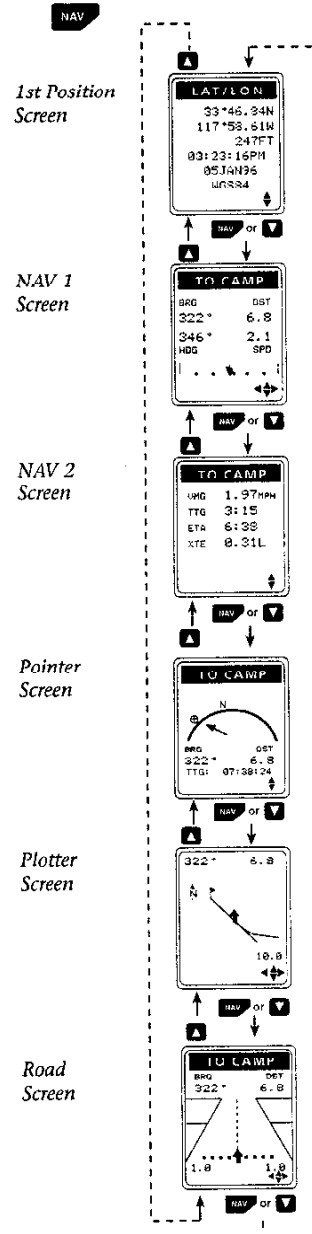

1st and 2nd POSITION Screen

The POSITION screens display position, elevation, and time of day.

From any NAV screen, access the 1ST POSITION screen by pressing NAV or the UP/DOWN ARROWs repeatedly. The 2ND POSITION screen may be viewed by activating it under 2ND POS SCR in SETUP; the 2ND POSITION screen becomes part of the screen sequence until it is deactivated.

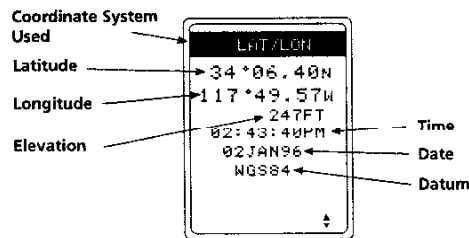

1ST POSITION Screen (with LAT/LON coordinated selected)

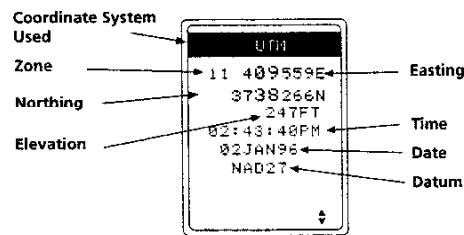

2ND POSITION Screen (with UTM coordinates selected)

Other coordinate systems are also available for use on the position screen by selecting them under COORD SYSTEM. If you are using another system, the coordinates will appear differently and may require a different datum. Refer to the map legend for the appropriate datum.

NAVI Screen

If the receiver has an active route or GO TO and is computing position fixes, this screen gives the bearing (BRG) and distance (DST) to the destination landmark of the current leg. In addition, if you are moving, the heading (HDG) and speed (SPD) are displayed. Access this screen using the UP/DOWN ARROWs from any of the other NAV screens or by pressing NAV repeatedly.

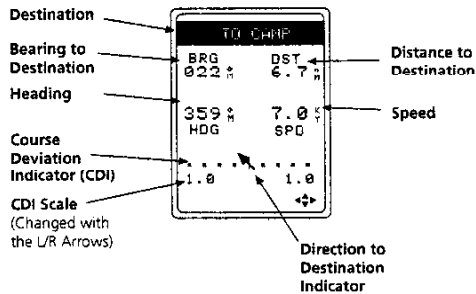

Course Deviation Indicator (CDI). The CDI is a graphical indication of your position relative to your planned course, giving you an indication of how far left or right of the planned course you are and the direction you need to turn to get to the destination. The **Direction to Destination** indicator will be located on one of the dots or in the center of the CDI.

The distance units (miles, nautical miles, or kilometers) can be selected from the Setup menu.

 For distances exceeding 999, the units (NM, MI or KM) are not shown on the NAV screen due to space constraints. (e.g. 1000 MI will read simply "1000".)

You can use the **RIGHT/LEFT ARROW**s to change the scale. Each dot represents a quarter unit.

.....↑..... With the arrow in the center you are on course. With the arrow pointing straight ahead you should continue moving in the same direction you are heading to arrive at the destination. If the arrow points downward, you are on the course line, but traveling in the opposite direction. If the receiver is not moving, the arrow points up as a default.

.....↖..... With the arrow on the first dot to the right, you are to the right of the course line. The arrow points approximately 45° to the left so not only do you need to move to the left, you need to turn to the left as well.

.....←..... The horizontal arrow on the third dot to the left indicates you are traveling approximately 90° to the left of your destination.

NAV 2 Screen

In addition to the NAV 1 screen the GPS 4000 XL can display a NAV 2 screen which contains additional navigation information for your route.

If the receiver has an active route or GO TO and is computing position information, the *NAV 2* screen displays VMG (velocity made good) to the destination landmark of the active (current) leg. In addition, if you are moving, the TTG (time to go), ETA (estimated time of arrival), and XTE (cross track error) are displayed. Access the *NAV 2* screen by using the UP/DOWN ARROWs from any of the other NAV screens or by pressing NAV repeatedly.

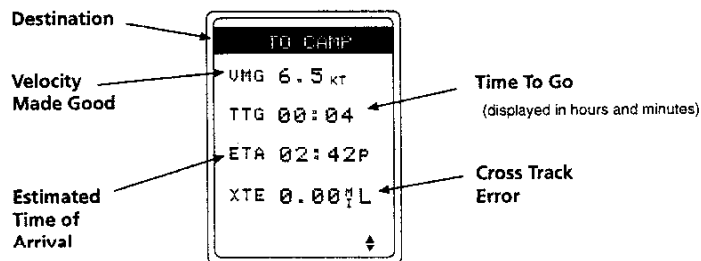

Cross Track Error (XTE) is represented numerically in the distance units selected from the SETUP MENU. If the cross track error is to the left of the courseline, the displayed value shown with an "L" after it or an "R" if the cross track error is to the right.

The cross track error value is displayed to two decimal places for distances of 9.99 distance units or less, and with one decimal place for distances over 9.99 distance units.

Customizing the NAV Screens

The *NAV 1* and *NAV 2* screens can be customized to display the data fields you find most convenient for navigation.

When you access these screens for the first time, the fields shown are the default choices. The *NAV 1* screen displays BRG, DST, HDG, and SPD fields, while the *NAV 2* screen displays VMG, TTG, ETA, and XTE fields.

Available options include:

BRG	Bearing to the active landmark
DST	Distance to the active landmark
SPD	Speed
HDG	Heading
VMG	Velocity made good toward active landmark
CTS	Course to steer
ETA	Estimated time of arrival (NAV 2 only)
TTG	Time to go to the active landmark (NAV 2 only)
XTE	Cross track error (NAV 2 only)

Press the NAV key from any screen to view a NAV screen. Continue to press NAV as necessary until the NAV screen is shown.

Press ENTER to display the pop-up menu. Use the UP/DOWN ARROWs to highlight CUSTOMIZE. Press ENTER.

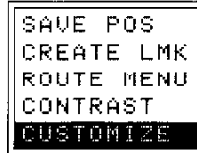

The pop-up menu disappears and the display returns to the NAV screen from which you came.

Customizing the NAV 1 Screen

When the pop-up menu disappears and the display returns to the NAV 1 screen, the first field is highlighted. (The first default is BRG, but another option may appear if you have previously customized the fields.)

Use the UP/DOWN ARROWs to select the field to edit, and the RIGHT/LEFT ARROWs to scroll through the various options for each field.

After you have selected an option, press the UP/DOWN ARROWs to move to the next field, where you scroll through the list of options again using the RIGHT/LEFT ARROWs.

When you have finished selecting all of the options you wish to include in the NAV 1 screen display, press ENTER to exit and save the selections.

Customizing the NAV 2 Screen

When the pop-up menu disappears and the display returns to the NAV 1 screen, the first field is highlighted. (The first default is VMG, but another option may appear if you have previously customized the fields.)

Use the UP/DOWN ARROWs to select the field to edit, and the RIGHT/LEFT ARROWs to scroll through the various options for each field.

After you have selected an option, press the UP/DOWN ARROWs to move to the next field, where you scroll through the list of options again using the RIGHT/LEFT ARROWs.

When you have finished selecting all of the options you wish to include in the NAV 2 screen display, press ENTER to exit and save the selections.

POINTER Screen

If there is an active GO TO or route this screen points to your destination and displays bearing, distance, and Time To Go to reach the destination. Access this screen using the UP/DOWN ARROWs or the NAV key from any of the other NAV screens. If you are moving, the top of the screen is referenced to the direction you are moving, otherwise, the top of the screen is referenced to North.

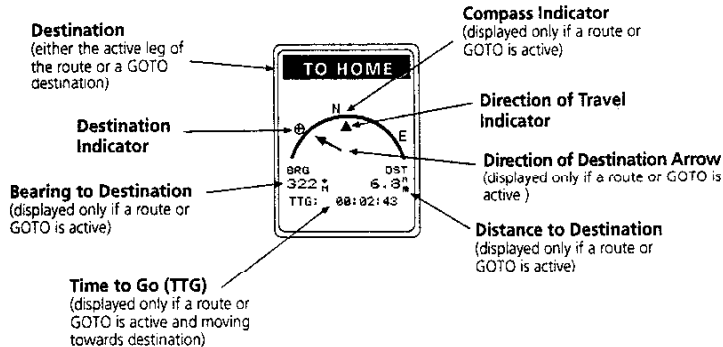

 If the destination is more than 90° to the left or right of your current position, the Destination Indicator disappears but the Direction to Destination arrow (→) will still point towards the destination. The Direction of Travel indicator, (▲), is displayed when you are moving. The top of the screen is referenced to your direction of travel. If the Direction of Travel indicator is not shown, then the receiver is not moving (at least 1 mph) and the top of the screen is referenced to North.

 The Direction to Destination arrow (→) appears when a route or GO TO is active. If the receiver is moving, the top of the display should be pointed straight in front of you so that the arrow will indicate which way you need to turn to head toward the destination landmark. If you are not moving, the arrow still appears but the top of the display is referenced to North.

PLOTTER Screen

This screen provides you with a track history of your route traveled, and your bearing and distance to the destination indicated at the top of the screen. Access this screen using the UP/DOWN ARROWs from any of the other NAV screens.

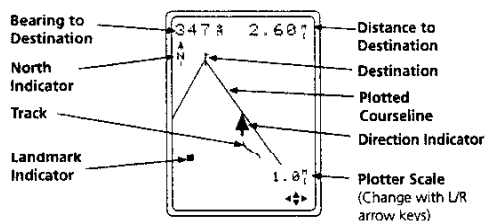

The Direction Indicator (located near the center of the screen) is also your current position as it relates to the plot drawn. The screen is dynamic and updates as you are viewing this display.

The Plotter Scale is shown in the lower portion of the display. Using the RIGHT/LEFT ARROWs, adjust the plotter scale to .20, .50, 1.0, 2.0, 5.0, 10, 20, 50, or 100 distance units. The selected scale represents the distance from the left to the right edge of the screen.

Deleting Plotter Track

The DELETE TRK option in the *PLOTTER* screen NAV menu allows you to clear track history on the *PLOTTER* screen.



From the *PLOTTER* screen, press ENTER to access the *PLOTTER* screen NAV menu. Highlight DELETE TRK and press ENTER.

A confirmation screen appears. Select YES to delete the track, or NO to return to the *PLOTTER* screen without erasing track and press ENTER. To exit the confirmation screen and return to the NAV menu, press CLR.



Since the receiver stores the track history, it is advisable to delete the track before navigating on a new route or GO TO to avoid unnecessary clutter on the *PLOTTER* screen.

Accessing the PAN N SCAN Functions

The GPS 4000 XL is equipped with a PAN N SCAN function that allows you to access landmark information relative to your position by placing the cursor over the landmark on the *PLOTTER* screen



From the *PLOTTER* screen, press ENTER to access the NAV MENU. You will notice that this menu is different from the NAV MENU accessed from other navigation screens in that it has two additional features, PAN N SCAN and DELETE TRK.

Highlight PAN N SCAN and press ENTER.

The *PAN N SCAN* screen is similar to the *PLOTTER* screen, however a vertical and horizontal line form a crosshair cursor.

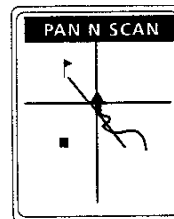

Use the UP/DOWN and RIGHT/LEFT ARROWs to move the crosshairs anywhere on the screen or beyond.

When the cross hairs cover a landmark on the screen, represented by a solid square, the screen's title bar displays the name of the landmark.

Just below the landmark name, the bearing (BRG) and distance (DST) to reach the landmark covered by the crosshairs are displayed.

Landmarks are represented by ■, Destinations are represented by ▸.

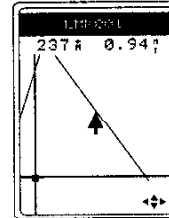

Creating a Landmark From PAN N SCAN

Press ENTER when the cross hairs are not positioned over an icon to display the PAN N SCAN submenu with the options CREATE LMK and GO TO.

Highlight CREATE LMK and press ENTER.



The *CREATE LMK* screen appears. Use the UP/DOWN and RIGHT/LEFT ARROWs, to assign a name to the new landmark or press ENTER to accept the unit-generated landmark name whose coordinates will be those of the crosshairs position.

Viewing a Landmark Message in PAN N SCAN

Position the crosshairs on the *PAN N SCAN* screen over an icon until the landmark name, bearing to the landmark, and distance to the landmark are displayed. Press ENTER to bring up the PAN N SCAN submenu. With a landmark selected the menu options are VIEW MSG and GO TO.



Highlight VIEW MSG and press ENTER.



If you have not attached a message to the landmark selected at the crosshair position, the message "NO MESSAGE" is displayed.

Creating a GO TO Route in PAN N SCAN

Position the cursor on the *PAN N SCAN* screen over an icon until the landmark name, bearing to the landmark, and distance to the landmark are displayed. Press ENTER. The PAN N SCAN submenu is displayed.



Select **GO TO** from the Menu and press **ENTER**. The receiver sets a **GO TO** route to the selected landmark and returns to the *PLOTTER* screen.



Creating a **GO TO COORD** from *PAN N SCAN*

Position the cursor on the *PAN N SCAN* screen at the point to which you wish to navigate, where no landmark exists. Press **ENTER**. The *PAN N SCAN* submenu appears with the options **CREATE LMK**, and **GO TO**.

Select **GO TO** and press **ENTER** to create a **GO TO** route to the coordinates at the crosshairs position and return to the *PLOTTER* screen, which now displays a course line from your present position to the **COORD** just created.



This **LMK COORD** created is temporary and will be removed from memory when the receiver is powered off.

ROAD Screen

The *ROAD* Screen provides a graphical representation of cross track error and a course direction indicator. Access this screen using the **UP/DOWN ARROWS** from any of the other *NAV* screens.

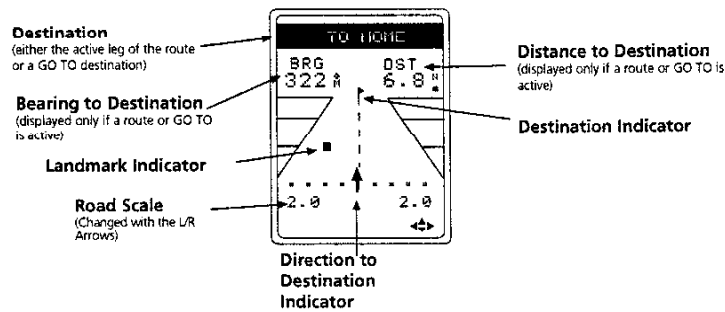

Use the **RIGHT/LEFT ARROWS** to adjust the scale of the **CDI** or 0.2, 0.4, 1.0, 2.0, 4.0, or 8.0 distance units.

Viewing Destination Landmark Messages

When the destination landmark of the leg of the route you are navigating on or the destination landmark of a GO TO has an attached menu, the GPS 4000 XL provides you with a convenient method of viewing the message.

While you are navigation on a route or a GO TO you can press the ENTER key from any NAV screen to display the NAV pop-up menu. If the destination landmark has an attached message the last menu item in the pop-up menu will be VIEW MSG. From here you can access the VIEW MSG menu item and be presented with a MESSAGE screen displaying the attached message. If there is not a VIEW MSG option, press CLR to return to the NAV screen.

To view the attached message:



From any NAV screen press ENTER. If the destination landmark has an attached message highlight VIEW MSG and press ENTER.

The pop-up menu shown here is for the NAV 1 screen and may differ as to the options available depending upon which NAV screen you are viewing but in all cases, if a message is available, VIEW MSG will be at the bottom of the pop-up menu.

The MESSAGE screen is displayed. The top half of the screen displays the attached message and the bottom half of the screen displays CLOSE if you are within 0.2 distance units of the landmark.

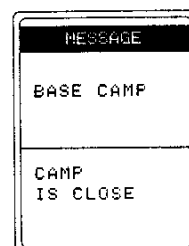
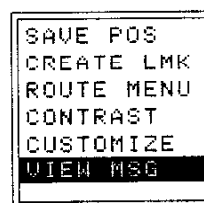

See the section *Working with Landmarks* for information on creating the attached messages.

The Bell Icon Alert

While navigating with the GPS 4000 XL you will be alerted by the bell icon at the bottom of the display when you are within 0.2 distance units of the approaching destination landmark, whether you are on a route or a GO TO. The bell icon will remain on until you begin navigating on the next leg of the route if you are using a multileg route, or in the case of a GO TO, the bell will remain on as long as you are within 0.2 distance units of the GO TO landmark.

Working with Landmarks

Landmark is the term used to describe an exact location or position that the GPS 4000 XL has stored in its memory. The GPS 4000 XL uses these landmarks as reference points in routes. As you become more familiar with routes and navigating with your GPS 4000 XL, landmarks and their usage will become readily apparent.

Saving a Position as a Landmark

This feature allows you to store into the receiver's memory the current position as a landmark.

From any NAV screen, press ENTER, highlight SAVE POS and press ENTER. This tells the receiver that you want to store the current position as a landmark. The cursor is in the upper left corner of the display, in edit mode, enabling you to assign a name to this position. From here the landmark name can be user-created or receiver-generated as described below.

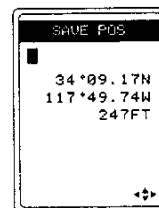

The landmark's name may be created by the user, (keyed with the UP/DOWN and RIGHT/LEFT ARROWS) or created automatically by the receiver.

The landmark name can be created by the receiver or you can input a name yourself to designate, for example, a deer stand, a fishing hole or where you left your truck. If you press ENTER without creating a name the receiver assigns a landmark name. Landmark names assigned by the receiver appear in the format LMKxxx, where the xxx is a sequential number (001, 002, etc. up to 200).

Saving the Position as a Landmark (Receiver-Created Name)

To allow the receiver to name the landmark, press ENTER. After pressing ENTER the receiver presents the option to add a message to the newly created landmark. Select NO if no message is desired or select YES and input a message for this landmark using the UP/DOWN ARROWS to change the cursor character and the LEFT/RIGHT ARROWS to change the cursor position.



If YES, use arrows to enter message. Press ENTER when done.

Saving the Position as a Landmark (User-Created Name)



Use the **ARROWs** to assign a landmark name that describes the position being saved. A landmark name can have from 1 to 6 characters. When you have finished entering the name, press **ENTER**. After pressing **ENTER** the receiver presents the option to add a message to the newly created landmark. Select **NO** if no message is desired or select **YES** and input a message for this landmark using the **UP/DOWN ARROWs** to change the cursor character and the **LEFT/RIGHT ARROWs** to change the cursor position.



You may save a landmark from any NAV screen. You may also save a landmark from the *PAN N SCAN* screen. (Refer to *Accessing PAN N SCAN Functions* for details.)



If you attempt to assign the same name to more than one landmark, the message **DUPLICATE LANDMARK NAME** appears on the screen. Press the **CLR** key to return to the pop-up menu and try again.

Attaching a Message to a Landmark

After creating a landmark, whether by saving your current position or by entering position coordinates you will be prompted to create a message. This allows you to attach a message to the landmark that can better describe or provide additional information about the landmark. Landmark messages can contain up to two lines of text with a maximum of 10 characters per line. A maximum of 25 landmarks may have messages.



Note that the **ENTER** key does not move the cursor to the next line in the message. You must use the **LEFT/RIGHT ARROWs** to move the cursor to the next line.

After creating a landmark or saving a position you will be prompted as to whether or not you wish to create a message. To create the message, highlight YES and press ENTER.

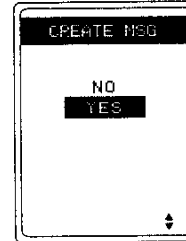

The CREATE MSG screen is displayed allowing you to use the arrow keys to enter your message. The LEFT/RIGHT ARROWs move the cursor to the left or right respectively. The UP/DOWN ARROWs scroll through the available alphanumeric characters. When you have finished composing your message, press ENTER and the display returns to the last viewed NAV screen.



If there are already 25 landmarks with attached messages you will be presented with the alert message, MESSAGES ALL USED. Press ENTER to leave this screen and return to the last viewed NAV screen.

It is possible to add a message to this landmark but you will first need to delete a message from a landmark or completely delete a landmark that has a message attached. You may then add a message to this landmark using the EDIT LMK function. See *Working with Landmarks* for a complete explanation of all these functions.

Creating a Landmark with User-Entered Coordinates

This is similar to saving a position as a landmark but offers the ability to change the coordinates to ones of your choice. As in *Saving a Position as a Landmark*, you can assign a name to this landmark or have the receiver automatically generate a landmark name.

From any NAV Screen	ENTER	Highlight CREATE LMK Press ENTER	ENTER	Use arrows to enter a landmark name and press ENTER or press ENTER by itself to use a receiver-generated name
Use arrows to change coordinate information. Press ENTER to move to the next line.			ENTER	Message? NO YES Press ENTER
If YES, use arrows to enter message. Press ENTER when done.				

From any NAV screen, press the **ENTER** key. Use the **UP/DOWN ARROW** keys to highlight **CREATE LMK**.

Press **ENTER** to display the *CREATE LMK* screen

Either input a landmark name (with the **UP/DOWN** and **RIGHT/LEFT ARROW**s) and press **ENTER** or press **ENTER** without entering a name and the receiver will automatically assign a name.



There are three possible formats for LAT/LON coordinates: DEG/MIN.MM, DEG/MIN.MMM, and DEG/MIN/SEC (see Changing Coordinate Systems in *Customizing the Receiver*). In all formats MIN can never be set greater than 59 and in DEG/MIN/SEC the SEC can never be greater than 59.

Input the desired latitude using the **UP/DOWN ARROW**s to scroll through the number list, and use the **RIGHT/LEFT ARROW**s to move the cursor left and right. With the cursor on the last character in the latitude the **UP/DOWN ARROW** toggles between N and S. Press **ENTER** to confirm and continue.



Input the desired longitude using the **RIGHT/LEFT** and the **UP/DOWN ARROW**s. With the cursor on the last character in the longitude the **UP/DOWN ARROW** toggles between E and W. Press **ENTER** again to save the changes.

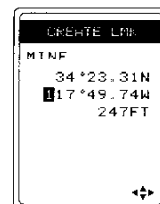

You may now input the elevation. If you do not know the elevation, press **ENTER** to accept the displayed value.

The **CREATE MSG** screen is displayed prompting you as to whether or not you want to add a message to this landmark. Highlight **YES** and press **ENTER** to add a message. The prompt is removed and you may use the arrow keys to enter a message. Press **ENTER** when you have completed the message.

See *Attaching a Message to a Landmark* for more information on attaching a message.

Viewing a Stored Landmark

The receiver has a storage capacity of 200 landmarks. Each one may be viewed through the menu of landmark names.

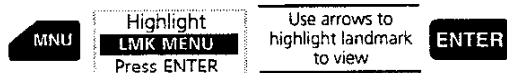

Press **MNU**. Use the **DOWN ARROW** to highlight **LMK MENU**.

Press **ENTER**. The *Landmark Menu* appears, listing all recorded landmarks in two columns, displayed alphabetically or in order of closest to farthest from your current position (**NEAREST**). You can change the order that the landmarks are displayed to alphabetic by using **Landmark Sort** from the **SETUP** menu. See *Customizing the GPS 4000 XL* for more information.

Use the **UP/DOWN** and **RIGHT/LEFT ARROWS** to scroll through the list, which may extend to more than one screen and include up to 200 named landmarks.



Press **ENTER** to view the stored landmark. This screen indicates the bearing (**BRG**) and distance (**DST**) to the landmark from the current position as well as the position information for the landmark. The time and date displayed indicates when the landmark was created.

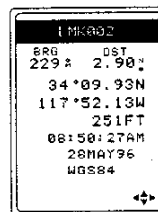

While you are viewing a stored landmark you can use the **RIGHT/LEFT ARROWS** to page through the other landmarks in the list. The **UP/DOWN ARROWS** are used to scroll through the **1ST POSITION** and **2ND POSITION** screens for the landmark as well as any attached message.

Press **CLR** to return to the previous menu or **NAV** to exit the View Landmarks function.

Viewing a Landmark Message

While viewing a stored landmark you may view and/or edit the associated message for the displayed landmark. Use the UP/DOWN ARROWs to view the MESSAGE screen.

Editing a Landmark Message

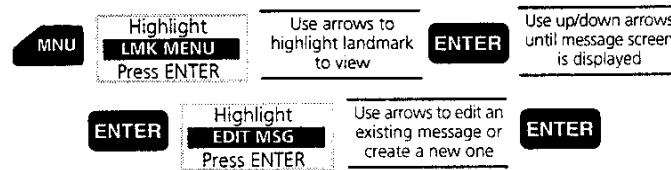

Press MNU. Use the UP/DOWN ARROWs to select LMK MENU and press ENTER. Use the ARROWs to highlight a landmark from the landmark list and press ENTER to access the LANDMARK screen.

Use the UP/DOWN ARROWs to access the MESSAGE screen and press ENTER to bring up the message submenu. Highlight EDIT MSG and press ENTER. (If you decide not to edit the message, press CLR to return to the MESSAGE screen.)



The cursor is active on the first character of the message. Use the UP/DOWN and LEFT/RIGHT ARROWs to edit the message and press ENTER when done. The display returns to the MESSAGE screen.

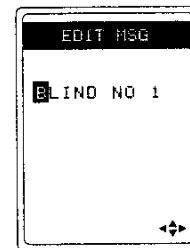

Deleting a Landmark Message

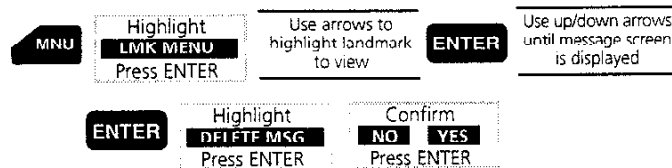

Press MNU. Use the UP/DOWN ARROWs to select LMK MENU and press ENTER. Use the ARROWs to highlight a landmark from the landmark list and press ENTER to access the LANDMARK screen.

Use the UP/DOWN ARROWs to access the MESSAGE screen and press ENTER to bring up the message submenu. Highlight DELETE MSG and press ENTER.

The DELETE MSG screen is displayed with a prompt requiring that you confirm the message deletion. Highlight YES to delete the message or NO to leave the message intact and press ENTER.

The display returns to the MESSAGE screen which now indicates "NO MESSAGE."

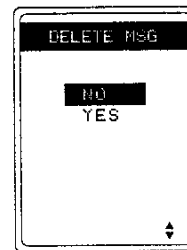

Projecting a Landmark

This function allows you to project a landmark, which means to create a landmark at a certain distance and direction from an existing landmark, landmarks, or from your current position. There are three methods of projecting a landmark: LMK PROJECT (landmark projection), MAP PROJ (map projection), and TRIANGULATION.

There are two ways to access the landmark projection menu. It can be accessed from the POSITION screen or from an existing landmark in the receiver's memory.

From the Position Screen

To project a landmark from your present position, access the POSITION screen and press ENTER to access the position submenu. Highlight PROJECTION and press ENTER. Another menu is displayed with the options LMK PROJ, MAP PROJ, and TRIANG.

From an Existing Landmark

To project a landmark from an existing landmark, press MNU. Use the DOWN ARROW to highlight LMK MENU and press ENTER. Scroll using the UP/DOWN or RIGHT/LEFT ARROWs and select the landmark you wish to use to project a new landmark from and press ENTER. From this landmark screen, press ENTER to access the landmark function menu.

From the landmark function menu, select PROJECTION and press ENTER. Another menu is displayed with the options LMK PROJ, MAP PROJ, and TRIANG.

The three types of landmark projection methods differ in what information is required. A brief explanation of each method and how the required information is entered will now be described.



Landmark Projection (LMK PROJ). Landmark projection uses the distance and bearing from an existing landmark to “project” a new landmark.

After selecting LMK PROJ from the landmark projection submenu, the *LMK PROJ* screen appears with the cursor positioned on the first character in the distance field (DIST).

Use the UP/DOWN and LEFT/RIGHT ARROWs to key in the distance at which you wish to project the new landmark. When you have finished, press ENTER to confirm and continue.

The cursor appears in the bearing field (BRG). Use the UP/DOWN and LEFT/RIGHT ARROWs to key in the bearing at which you wish to project the new landmark. Press ENTER to confirm.

The coordinates of the projected landmark you have just created appear on the *LMK PROJ* screen.

To save these coordinates as a landmark press ENTER. (Pressing CLR or NAV exits without saving the landmark.) You may assign a name using the UP/DOWN and LEFT/RIGHT ARROWs and press ENTER, or press ENTER without entering any information to accept a receiver-generated name. You will then be given the option of creating a message for this landmark.

The projected landmark is saved as a new landmark.

The display returns to the *LANDMARK* screen from which you projected the new landmark.

Triangulation (TRIANG). This form of projection uses two different landmarks with a user-entered bearing from each. The point that these two bearings cross will be the coordinates for the “projected” landmark.

After selecting TRIANG from the landmark projection submenu, the *TRIANG* screen appears. Use the LEFT/RIGHT ARROWs to select the current position (POS) or a saved landmark. Press ENTER and the cursor moves to the BRG (bearing) line. Use the UP/DOWN and RIGHT/LEFT ARROWs to key in the bearing from the selected landmark. Press ENTER.

The display now prompts you to select a different landmark. Use the RIGHT/LEFT ARROWs to select the current position (POS) or a saved landmark. Press ENTER and the cursor moves to the BRG (bearing) line. Use the UP/DOWN and RIGHT/LEFT ARROWs to key in the bearing from the selected landmark.



If you select the same landmark for both landmarks or if the two landmarks you select have the same coordinates, an alert will be displayed. Press ENTER to select a different landmark.



The coordinates of the projected landmark you have just created appear on the *TRIANG* screen.

To save these coordinates as a landmark press **ENTER**. You may assign a name using the **UP/DOWN** and **RIGHT/LEFT ARROW**s and press **ENTER**, or press **ENTER** without entering any information to accept a receiver-generated name. You will then be given the option of creating a message for this landmark.

The projected landmark is saved as a new landmark.

The display returns to the *LANDMARK* screen from which you projected the new landmark.

Map Projection (MAP PROJ). [Recommended for use with UTM Grids only.] Using a map with UTM grids you can project a landmark onto the map.



Since the GPS 4000 XL will be using distances measured on a map the **MAP SCALE** in the receiver must be the same as the map you are using. To change the map scale; press **MNU**, highlight **SETUP** and press **ENTER**, highlight **MAP SCALE** and press **ENTER**. The *MAP SCALE* screen is displayed. Use the **ARROW** keys to set the map scale to be the same as on the map you are using. Press **ENTER**. Use the **LEFT/RIGHT ARROW**s to select the scale of the ruler that you will be using to measure the map with. Press **ENTER** to accept.

After selecting *MAP PROJ* from the landmark projection submenu, the *MAP PROJ* screen appears. The receiver prompts you to enter the northing and easting in inches or centimeters (selected in *SETUP*) from which to compute the coordinates of the projected landmark. Enter the northing and easting using the **ARROW** keys and press **ENTER** after each selection.

The coordinates of the projected landmark you have just created appear on the *MAP PROJ* screen.

To save these coordinates as a landmark press **ENTER**. You may assign a name using the **UP/DOWN** and **LEFT/RIGHT ARROW**s and press **ENTER**, or press **ENTER** without entering any information to accept a receiver-generated name. You will then be given the option of creating a message for this landmark.

The projected landmark is saved as a new landmark.

The display returns to the *LANDMARK* screen from which you projected the new landmark.

Editing a Landmark

This function allows you to permanently change the name, coordinate values, or elevation of a stored landmark.

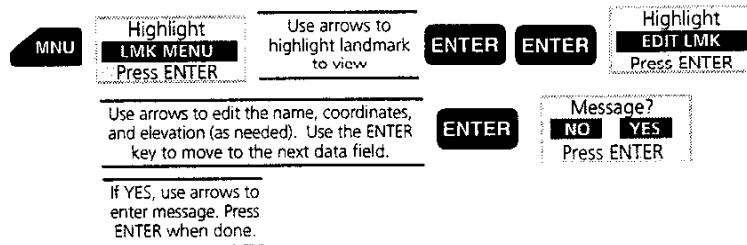

If the landmark name you are changing is currently used in a route or is the destination of a **GO TO**, an error message appears. Use the **CREATE LMK** function instead, or use a different name.

Press **MNU**. Use the **DOWN ARROW** to highlight **LMK MENU** and press **ENTER**.

The **LMK MENU** screen appears, listing all recorded landmarks by name. Landmark names are displayed in two columns and may continue to more than one page.

Use the **ARROW** keys to scroll through the list, which may include up to 200 named landmarks. Holding the arrow key down will allow the GPS 4000 XL to auto-scroll through the landmark list; the list may continue to several pages. **RIGHT/LEFT ARROW**s move between columns and from the last landmark on one page to the first landmark on the succeeding page. Highlight the landmark you wish to edit, then press **ENTER**.

The **LANDMARK** screen appears, showing the name of the selected landmark, its position and elevation.

Press **ENTER** to display the landmark function menu. Highlight **EDIT LMK** and press **ENTER**. The **LMK EDIT** screen appears with the cursor positioned in the upper left corner.

Rename the landmark, if desired, (up to 6 characters) using the **UP/DOWN ARROW**s to go through the alphanumeric scroll, and the **RIGHT/LEFT ARROW**s to position the cursor. Press **ENTER** when you have finished renaming the landmark.

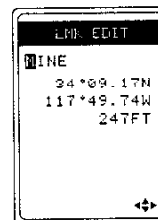

Follow the same procedure to edit the coordinates and elevation, if desired, confirming each entry with **ENTER**. The changes are recorded and the receiver returns to the *Landmark* screen.



If you attempt to use a name that is already assigned to a landmark, the message **DUPLICATE LANDMARK NAME** appears on the screen. Press the **CLR** key to return to the pop-up menu and try again.

Deleting a Landmark

Permanently removes a saved landmark from the receiver's memory.

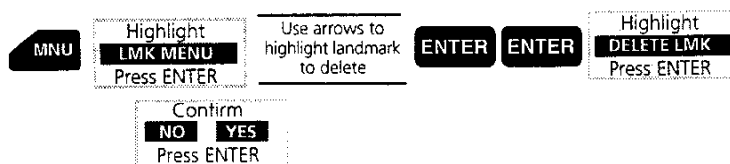

Press **MNU** key, then use the **DOWN ARROW** to highlight **LMK MENU**. Press **ENTER**. The *Landmark Menu* screen appears, displaying the names of all recorded landmarks.

Use the **UP/DOWN ARROWS** to highlight the landmark you wish to delete and press **ENTER**.

A landmark screen will appear showing the name, coordinates, bearing, distance and time and date of the selected landmark.

Press **ENTER** to access the landmark function menu. Use the **DOWN ARROW** to highlight **DELETE LMK** and press **ENTER**.

A **YES/NO** confirmation screen appears.

If you are certain that you wish to delete this landmark, then press **ENTER**. The landmark is deleted and the receiver displays the landmark screen for next landmark in the landmark list.

If you do not wish to erase this landmark, highlight **NO**, then press **ENTER**. The screen showing the selected landmark reappears.



If a landmark is contained in a route or a **GO TO**, it cannot be deleted without first clearing the route or reassigning a **GO TO**.

Using the LAST FIX Buffer

While the GPS 4000 XL is operating and taking position fixes it automatically saves a position (last fix) every 10 minutes and stores it in a special area called the LFIX buffer. The LFIX buffer, which contains up to 21 last fixes, is used when you activate the Backtrack function. When 21 fixes have been saved, the next fix is added and the oldest last fix is removed.

Viewing the Last Fix Buffer



Press MNU, and using the DOWN ARROW, select LAST FIXES.

Press ENTER to display the position screen for LFIX01 with the bearing and distance to the last fix and the time and date it was taken.

Use the RIGHT/LEFT ARROWs to scroll through the last fix buffer. (The LEFT ARROW goes back to earlier fixes.)

Copying a Last Fix as a Landmark

This function allows you to copy a last fix to the landmark list.

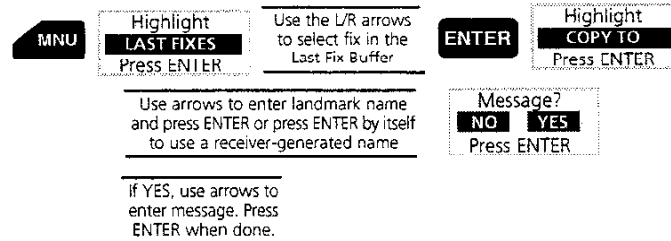

Press MNU, DOWN ARROW and select LAST FIXES.

Press ENTER to display the screen for LFIX01 with the bearing and distance to the last fix and the time and date it was taken.

Use the RIGHT/LEFT ARROWs to scroll through other fixes in the last fix buffer. (The LEFT ARROW takes you back to earlier fixes.)

Press ENTER from any last fix screen to call up the function menu, and select COPY TO.



Press **ENTER** to access the *COPY TO* screen.

Using the **UP/DOWN** and **RIGHT/LEFT ARROWS**, assign a name to the selected last fix to record it as a named landmark (up to 6 characters) without deleting it from the Last Fix Buffer. Press **ENTER** when you have finished renaming the landmark. You will be prompted to add a message to this landmark. Select **YES** to add a message.

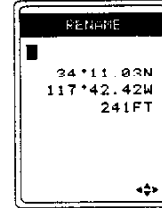

Deleting a Last Fix

This function allows you to delete a last fix from the Last Fix Buffer.

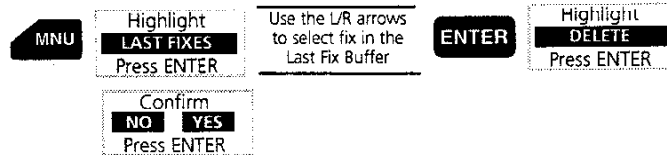

Press **MNU**, **DOWN ARROW** and select **LAST FIXES**.

Press **ENTER** to display the position screen for LFIX01 with the bearing and distance to the last fix and the time and date it was taken.

Use the **RIGHT/LEFT ARROWS** to scroll through other fixes in the last fix buffer. The **LEFT ARROW** goes back to earlier fixes.)

From the screen showing the Last Fix you wish to delete press **ENTER** to call up the function menu, and select **DELETE**. Press **ENTER**.

A confirmation screen appears. Highlight **YES** if you are certain that you wish to delete this Last Fix, press **ENTER**.

If you do not wish to delete this Last Fix, highlight **NO**, then press **ENTER**.



Last fixes are used to create backtrack routes; if you delete all last fixes, it will not be possible to create a backtrack until more last fixes are available.

Working with Routes

GO TO (Activating)

This creates and activates a GO TO, a single leg route from your current position to the landmark you select from the GO TO landmark list.

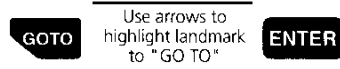

Press **GO TO**. A list of all recorded landmarks, the **ROUTE** and **BCKTRK** options, appears on the **GO TO** screen.

Use the **UP/DOWN** or **RIGHT LEFT ARROWS** to highlight the landmark to be used as the destination. The list of landmarks may extend to more than one screen as the GPS 4000 XL can store up to 200 landmarks. Press **ENTER**.



If the receiver is not locked and tracking satellites, the start of **GO TO** will be the last position computed, not necessarily the current position.

ROUTE Used to activate a route that is in memory and is not active. Selecting this option takes you to the **ROUTE MENU**. See *Activating a Route* for more details.

BACKTRACK The **BACKTRACK** option creates a route to take you back to your starting point by copying the 21 last fixes in inverse order to the first available route in the format **BX 01**, **BX 02** etc.

COORD The **COORD** option creates a **GO TO** to the coordinates of a position you enter manually.

Creating a Coordinate GO TO Route

Press **GO TO**, select **COORD** and press **ENTER**. Type in the coordinates to which you want to navigate and press **ENTER**.



The Coordinate **GO TO** Route is deleted from the receiver's memory when the GPS 4000 XL is turned off.

Creating a Backtrack Route

Press **GO TO**, select **BCKTRK** and press **ENTER**. The GPS 4000 XL displays a message indicating that it is creating a backtrack route and returns to the last viewed *NAV* screen.



If you press **GO TO** after creating a backtrack route you will notice that the receiver has created new waypoints with the name **-Bx-yy** (where **x** is the backtrack route number and **yy** is the waypoint number). These waypoints will remain in memory until you delete the backtrack route from the Route Menu (see *Deleting a Route*). After deleting the route, the **-Bx-yy** waypoints are automatically removed.



If there are no **EMPTY** routes the receiver will display the message "ROUTES FULL CLEAR ROUTE TO CONTINUE". This alerts you that you must delete a route (see *Deleting a Route*) before you may create a backtrack.

Accessing the Route Menu

The Route Menu is used to view a one-page list of up to five existing routes. A pop-up menu allows you to activate or deactivate, reverse, edit or delete the selected route, or view the legs of the route.

There are three ways of accessing the Route Menu.

Press **MNU** to access the Main Menu and select **ROUTE MENU**.



OR

From any **NAV** screen, press **ENTER** to access the submenu and select **ROUTE MENU**.



OR

Press **GO TO** to access the **GO TO** screen and select **ROUTE**.

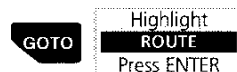

Press **CLR** to return to the **NAV** menu, **GO TO** menu or **Function** menu, depending on how the **Route Menu** was accessed.

Creating a Route

This function allows the creation of up to five multileg routes using any of the landmarks in memory. A route may contain from 1 to 20 legs.

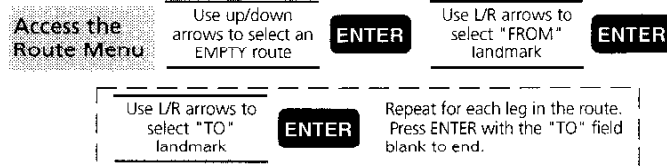

Access the ROUTE MENU by pressing **MNU**, **DOWN ARROW** to highlight ROUTE MENU, then **ENTER** or from any NAV screen press **ENTER**, **DOWN ARROW** to highlight ROUTE MENU, and **ENTER**, or press **GO TO**, select ROUTE and press **ENTER**.

The Route menu screen is displayed with five routes on one page. Use the **UP/DOWN ARROW**s to scroll through the routes.

Highlight an EMPTY route and press **ENTER**.

 If there are no empty routes in the Route Menu, you must delete a route before you can create a new one.

If you have a current position fix the first "FROM" landmark will be -STRTx where "x" is the current route number. This landmark represents your current position. You can select -STRTx if you want your route to begin at your current position.

Use the **RIGHT/LEFT ARROW**s to scroll through the list of landmarks and select the point of departure (FROM) for the first leg of the route. Press **ENTER**.



The selection is recorded and the cursor steps down to the TO line. Use the **RIGHT/LEFT ARROW**s to select the destination (TO) for the first leg of the route. The bearing and distance to the destination for this leg is also displayed and updated as you scroll through the various TO landmarks. Press **ENTER** when the desired landmark is displayed.

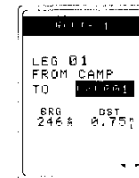

 The receiver will not accept the entry if the FROM landmark and the TO landmark have the same position or are less than 0.1 mi from each other.



The screen now shows LEG 02 of the route. You may continue to create this and other legs of the route by using the **RIGHT/LEFT ARROW**s and confirming with **ENTER** each time. When you have added as many legs to the route as desired (up to 20 legs), press **ENTER** with the TO field blank.

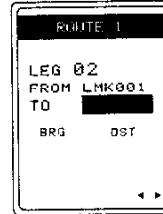

When you create a new route, this route automatically becomes the active route and the GPS 4000 XL begins navigating the first leg of the route, shown on the NAV screens.

Deactivating a Route

Used to deactivate (turn off) a route that is currently in use. The route is retained in memory and can be activated again later.

Access the Route Menu	Use up/down arrows to select a route	ENTER	Highlight DEACTIVATE Press ENTER
--------------------------	--	--------------	---

To deactivate a route, access the **ROUTE MENU** and highlight the desired route. Press **ENTER**. The word **DEACTIVATE** is highlighted at the top of the pop-up menu if the route is currently active.

Press **ENTER** to deactivate the route.



Selecting a new **GO TO** landmark (see *Creating a GO TO Route*) will also deactivate an existing route.

Activating a Route

Used to activate (turn on) a route that had been previously deactivated.

Access the Route Menu	Use up/down arrows to select a route	ENTER	Highlight ACTIVATE Press ENTER
--------------------------	--	--------------	---

Access the **ROUTE MENU**. Highlight the desired route and press **ENTER**.

The word **ACTIVATE** is highlighted at the top of the pop-up menu if the route is currently deactivated. Press **ENTER** while **ACTIVATE** is highlighted to activate the route. After activating the route, the receiver returns to the last viewed NAV screen.



Reversing a Route

Reverse Route takes the selected route in memory and reverses the order of the landmarks in the route, enabling you to return to your starting point. For example, a three-leg route from point A to B to C to D would be reversed, navigating back from point D to C to B to A.

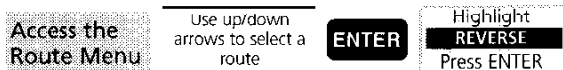

Access the ROUTE MENU. Select the desired route and press **ENTER** to access the pop-up menu.

Use the **DOWN ARROW** key to highlight **REVERSE** and press **ENTER**. After reversing the route the receiver returns to the Route Menu.



Editing a Route

The edit option displays a summary of the selected route, including starting and ending landmarks, number of legs, and total distance of the route. It allows you to view, insert, delete and replace individual legs of a route.



Access the ROUTE MENU. Select the desired route and press **ENTER** to access the pop-up menu.

Use the **DOWN ARROW** key to highlight **EDIT** and press **ENTER**.

Use the **UP/DOWN ARROWS** to scroll through the consecutive legs of the route. Pressing the **DOWN ARROW** displays Leg 1, Leg 2 and so forth. Pressing the **UP ARROW** displays the previous leg.

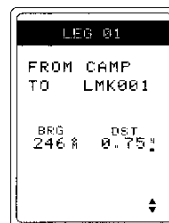

From the page displaying the leg of the route you wish to edit, press **ENTER** to access the **EDIT** menu. The **INSERT** or **ADD LEG** option is highlighted.

Adding a Leg to the End of a Route

This option allows you to add a landmark at the end of an existing route.

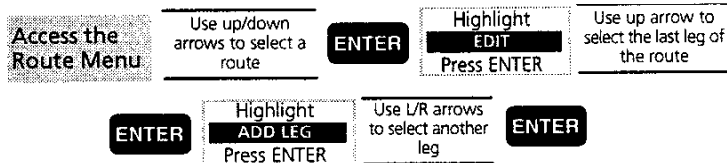

Access the ROUTE MENU. Use the DOWN ARROW key to highlight EDIT and press ENTER. Use the UP/DOWN ARROWs to scroll through to the last leg of the route and press ENTER to access the LEG EDIT menu. Highlight ADD LEG and press ENTER.

The cursor appears in the TO field. Use the RIGHT/LEFT ARROWs to scroll through the list of landmarks until you reach the landmark you wish to add to the end of the route. Press ENTER.



The landmark you add must be different from the original ending landmark by at least 0.1 mile. If the landmark added is too close to the previous landmark in the route, the unit displays the message "INVALID LEG."

Inserting a Leg in a Route

This option allows you to insert a landmark between the starting and ending points of the selected leg in the route.

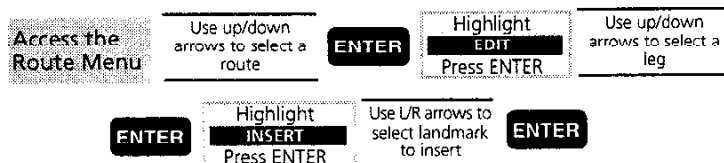

Access the ROUTE MENU. Use the DOWN ARROW key to highlight EDIT and press ENTER.

Use the UP/DOWN ARROWs to scroll through and highlight the leg of the route in which you wish to add a landmark.

Press ENTER to access the LEG EDIT menu, highlight INSERT and press ENTER. The cursor appears in the TO field.

Use the RIGHT/LEFT ARROWs to scroll through the landmark list until you reach the landmark to insert before the displayed leg. Press ENTER.

If you wish to cancel this operation, press CLR.



 The landmark you insert must be different from the original starting and ending landmarks by at least 0.1 distance units (i.e., 0.1 statute miles). If the landmark added is too close to the previous landmark in the route, the unit displays the message "INVALID LEG."

The screen returns to the leg edit menu.
When a new landmark is inserted in a leg, the current leg is divided into two legs and the numbering of the legs in the route adjusts to accommodate the new landmark.

Deleting a Leg From a Route

This function allows you to delete the destination landmark of a leg in a route, thereby deleting the leg itself, and leaving the route unbroken.

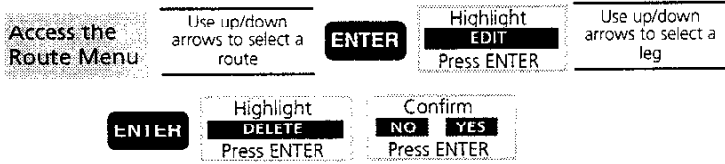

Access the ROUTE MENU. Select the desired route and press ENTER to access the pop-up menu.
Use the DOWN ARROW key to highlight EDIT and press ENTER.
Use the UP/DOWN ARROWS to scroll through and highlight the leg of the route you wish to delete. Press ENTER to access the LEG EDIT menu, highlight DELETE and press ENTER.
A confirmation screen appears. Select YES and press ENTER to delete the destination landmark shown, or select NO and press ENTER to cancel.

Replacing a Landmark in a Route

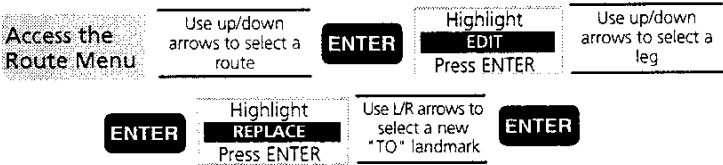

Access the ROUTE MENU. Select the desired route and press ENTER to access the pop-up menu.
Use the DOWN ARROW key to highlight EDIT and press ENTER.

Use the **UP/DOWN ARROW**s to scroll through and view the leg whose destination landmark you wish to replace. Press **ENTER** to access the **LEG EDIT** menu, highlight **REPLACE** and press **ENTER**.

Use the **RIGHT/LEFT ARROW**s to scroll through the list of landmarks until you reach the landmark you wish to insert in place of the destination landmark of the leg displayed. Press **ENTER**.

If you wish to cancel and escape, press **CLR**. When the leg is replaced, the screen returns to the **LEG EDIT** menu.



The landmark used as a replacement must be different from the original starting and ending landmarks by at least 0.1 distance units (i.e., 0.1 statute miles).

Viewing a Leg in a Route

VIEW enables you to graphically look at each leg of the route in memory.

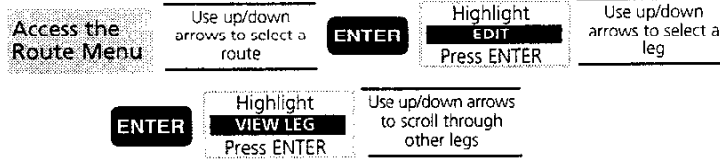

Access the **ROUTE MENU**. Highlight the desired route and press **ENTER**. Use the **DOWN ARROW** to highlight **EDIT**. Press **ENTER**.

Press **ENTER** again and use the **UP/DOWN** arrows to highlight **VIEW LEG** and press **ENTER**.

The **ROUTE** screen appears, showing a graphic representation of the first leg of the route.

Use the **UP/DOWN ARROW**s to view other legs of the route successively.

The word **ACTIVE** appears on the screen showing the active leg of the route.

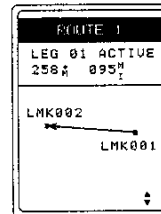

Activating a Leg of a Route

As you are navigating using a route you may find that you want to use a different leg in the route than the one that is currently active. This function will enable you to select a different leg in a route using the LEG EDIT menu and make that leg the active leg.

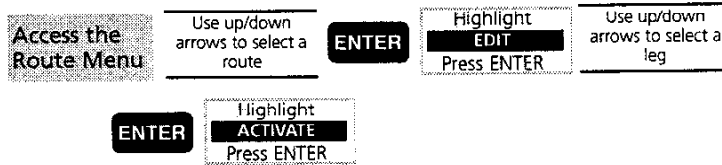

Access the ROUTE MENU. Select the desired route and press **ENTER** to access the pop-up menu. Use the **DOWN ARROW** key to highlight **EDIT** and press **ENTER**.

Use the **UP/DOWN ARROWS** to scroll through and display the leg you wish to activate, then press **ENTER**. To access the pop-up menu, choose **ACTIVATE** and then press **ENTER**.

The selected leg is activated and the display returns to the last viewed NAV screen, showing Navigation information for the active leg.

Deleting a Route

DELETE allows you to permanently clear a route from memory.



Access the ROUTE MENU. Highlight the route you wish to delete and press **ENTER** to access the pop-up menu. Use the **ARROW** keys to highlight **DELETE** and press **ENTER**.

A **WARNING** screen is then displayed requesting confirmation that you want to clear the route from memory.

Using the **UP/DOWN ARROW** keys, choose **YES** to confirm the **CLEAR** function, erasing the route from memory; or **NO** to abort the **CLEAR** function and return to the Route Menu. After making your selection press **ENTER**.

You may delete a route from memory whether it is activated or deactivated.

Using the SUN/MOON Screen

Accessing the SUN/MOON Screen

The SUN/MOON feature provides sunrise, sunset and lunar visibility information for the current or selected position on the entered date. You may select any date from 1980 through 2079. The unit displays only the last two digits of the year.

From POS
Screen

ENTER

Highlight
SUN/MOON
Press ENTER

Use arrows to
set date to
view

ENTER

From the *POSITION* screen or from any landmark screen, press **ENTER**. Highlight **SUN/MOON** and press **ENTER**.

The cursor appears on the first character of the current date. Press **ENTER** to confirm the date, or use the **UP/DOWN** and **RIGHT /LEFT ARROW**s to key in a different date, then press **ENTER**.

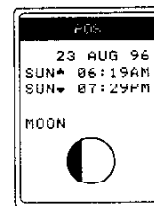

The times of the sunrise and sunset for the current or selected date and position appear. The graphic representation shows lunar visibility.

The moon symbol shown here represents a three-quarters moon.

Tracking with the Trip Odometer

This feature displays the **ODOMETER** screen which keeps track of total distance traveled as well as trip distance, similar to the odometer in an automobile.

Accessing the Odometer Screen

MNU

Highlight
ODOMETER
Press ENTER

Press **MNU** to access the Main Menu screen. Use the **UP/DOWN ARROW**s to highlight **ODOMETER** and press **ENTER**.

The **ODOMETER** screen appears, showing the total distance traveled and the distance traveled on the current trip.

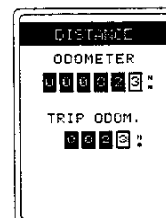

Resetting the Odometer

Press **ENTER** to display the reset menu. Use the **UP/DOWN ARROW**s to highlight **RESET ODOM** and press **ENTER**. (If you do not wish to clear the odometer, press **CLR** to return to the main menu.)

A confirmation screen appears. Select **YES** and press **ENTER** if you wish to reset, or select **NO** and press **ENTER** to return to the **ODOMETER** screen without resetting.

Resetting the Trip Odometer

Press **ENTER** to display the reset menu. Use the **UP/DOWN ARROW**s to highlight **RESET TRIP**. (If you do not wish to clear the trip odometer, press **CLR** to return to the main menu.)

A confirmation screen appears. Select **YES** and press **ENTER** if you wish to reset, or select **NO** and press **ENTER** to return to the **ODOMETER** screen without resetting.



Due to government imposed SA, the odometer figures may have errors. Do not rely on this feature for precise navigation.

Clearing Memory with CLEAR MENU

CLEAR MENU is used to globally delete last fixes, track, landmarks and routes, or everything in the receiver's memory.

MNU

Highlight
CLEAR MENU
Press **ENTER**

Press **MNU** to access the Main Menu screen. Use the **UP/DOWN ARROW**s to highlight **CLEAR MENU** and press **ENTER**. The **CLEAR MENU** screen appears. From here you can select what portion of the receiver's memory you want to clear.



Clearing All Last Fixes

This function clears all the Last Fixes from the Last Fix Buffer.



Press MNU to access the Main Menu screen. Use the UP/DOWN ARROWS to highlight CLEAR MENU and press ENTER.

Select LAST FIXES and press ENTER.

A confirmation screen then appears. Choose YES to confirm the clear function, or NO to abort and return to the CLEAR MENU screen, then press ENTER.

Clearing Plotter Track

This function of the CLEAR MENU deletes the track created on the PLOTTER screen. This helps reduce the clutter on the PLOTTER screen and can make the PLOTTER screen easier to read.



Press MNU to access the Main Menu screen. Use the UP/DOWN ARROWS to highlight CLEAR MENU and press ENTER.

Select TRACK and press ENTER.

A confirmation screen then appears. Choose YES to confirm the clear function, or NO to abort and return to the CLEAR MENU screen, then press ENTER.

Another way to delete track is directly from the PLOTTER screen. (See the section entitled DELETE TRACK.)

Clearing All Landmarks and Routes

This function clears all the landmarks from the Landmark Menu.



Press MNU to access the Main Menu screen. Use the UP/DOWN ARROWS to highlight CLEAR MENU and press ENTER.

Highlight LMKS/RTS (Landmarks/Routes) and press ENTER.

A confirmation screen then appears. Choose YES to confirm the clear function, or NO to abort and return to the *CLEAR MENU* screen, then press ENTER.

Clearing All Memory



Clearing all memory will require reinitializing the receiver as all user-entered information is lost and should be used with utmost care.

This function clears all user-entered memory, (including landmarks, routes, track, and last fixes) and turns the unit off.



Press MNU to access the Main Menu screen. Use the UP/DOWN ARROWs to highlight CLEAR MENU and press ENTER.

Select ALL and press ENTER.

A confirmation screen then appears. Choose YES to confirm the clear function, or NO to abort and return to the *CLEAR MENU* screen.

Customizing the GPS 4000 XL Satellite Receiver

Accessed from the Main Menu, Setup allows you to configure the receiver for your particular needs. Setup is also where you initialize the receiver by entering the approximate coordinates of your position to assist the receiver in getting the information it requires the first time you use the receiver, or in the unlikely event that it loses its memory.

Initializing

Allows you to establish the initial position for the receiver. This will enable the receiver to quickly search the sky for the satellites available in your area. See the *Getting Started* section for details on initializing your receiver.

Selecting a Coordinate System

This option allows you to select the coordinate system used for entering and viewing position information. The most common is LAT/LON which uses the lines (parallels and meridians) of latitude and longitude projected onto the earth and encircling it. Also available in the GPS 4000 XL are UTM, OSGB, Irish Grid, Swiss Grid, Swedish Grid, Finnish Grid and a User Grid.



Press **MNU** and use the **UP/DOWN ARROW**s to highlight **SETUP MENU** and press **ENTER**. Use the **UP/DOWN ARROW**s to highlight **COORD SYSTEM** and press **ENTER**.

If the **2ND POSITION** is active you will be given the choice between **1ST POS** or **2ND POS**. This will enable you to set a different coordinate system for each position display. Highlight **1ST POS** or **2ND POS** and press **ENTER**.

Use the **UP/DOWN ARROW**s to select the coordinate system and press **ENTER**.

Default values:

1st Position: LAT/LON, DEG/MIN.MM

2nd Position: UTM

If you select LAT/LON you will be asked if you want DEG/MIN.MMM, DEG/MIN.MM or DEG/MIN/SEC.



If you choose one of the first two options, the display is in decimal format, while the third option is based on 60 seconds in a minute. The coordinate system you ultimately select will depend upon the maps or charts that you use with your receiver.

Selecting the Elevation Mode

There are two options to choose from in setting the elevation mode; 3D (3-Dimensional) or 2D (2-Dimensional).

3D: Requires that at least four satellites be in view and spread out properly in the sky to compute a position fix, and **will** compute elevation. If only three satellites are in view while in the 3D mode, the GPS 4000 XL will automatically switch to 2D and stay in 2D until a fourth satellite is available.

2D: Requires at least three satellites in view to compute a position fix but **will not** compute elevation. Displayed elevation will be the last computed or user-entered elevation. A "2D" icon will appear at the bottom of the screen when the last fix taken is in the 2D mode.



Press MNU and use the UP/DOWN ARROWs to highlight SETUP MENU and press ENTER. Use the UP/DOWN ARROWs to highlight ELEV MODE and press ENTER.

Use the UP/DOWN ARROWs to highlight your selection, (3D or 2D), then press ENTER. The screen returns to the SETUP menu.

Default value: 3D

 If 2D is selected, the 2D icon will not appear on the bottom row of the display until **after** a position fix has been computed.

Selecting Time Display and Changing the Time

Allows you to select the mode that you want time displayed in. Can be set to local 24-hour, local 12-hour (AM/PM), or UT (universal time).

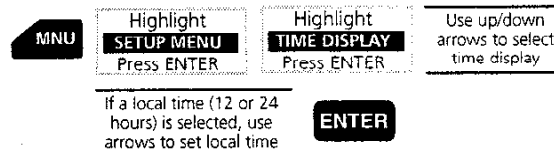

Press MNU and use the UP/DOWN ARROWs to highlight SETUP MENU and press ENTER. Use the UP/DOWN ARROWs to highlight TIME DISPLAY and press ENTER.

Use the UP/DOWN ARROWs to select the mode desired; LOCAL 24HR, LOCAL AM/PM, or UT and then press ENTER. After selecting LOCAL 24HR or LOCAL AM/PM you are prompted to enter the current local time. Use the UP/DOWN ARROWs to change local time. The time you enter needs to be within 30 minutes of the correct time. Press ENTER when finished.

Default value: LOCAL AM/PM

 Please note that if you are located in a half hour time zone, you will need to manually reset the time, after the receiver has taken its first position fix, by adding or subtracting one half hour.

Selecting Speed Units

Allows you to select the unit of measure for speed measurements.



Press MNU and use the UP/DOWN ARROWs to highlight SETUP MENU and press ENTER. Use the UP/DOWN ARROWs to highlight SPEED UNITS and press ENTER.

Use the UP/DOWN ARROWs to select the unit of measure desired; knots (KNOTS), miles per hour (MPH), or kilometers per hour (KPH), then press ENTER.

Default value: MPH



On some screens where space is limited, KPH is expressed as KH, MPH is expressed as MH and KNOTS is expressed as KT.

Selecting Distance Units

Allows you to select the unit of measure for distance values.



Press MNU and use the UP/DOWN ARROWs to highlight SETUP and press ENTER. Use the UP/DOWN ARROWs to highlight DIST UNITS and press ENTER.

Use the UP/DOWN ARROWs to select the unit of measure desired; nautical miles (NAUT MILES), statute miles (ST MILES), or kilometers (KM), then press ENTER.

Default value: ST MILES

Selecting Elevation Units

Allows you to select the unit of measure for displaying elevation values.



Press MNU and use the UP/DOWN ARROWs to highlight SETUP MENU and press ENTER. Use the UP/DOWN ARROWs to highlight ELEV UNITS and press ENTER.

Use the UP/DOWN ARROWs to select the unit of measure desired; METERS or FEET and then press ENTER.

Default value: FEET

Selecting the North Reference

Allows you to select the value of north (magnetic or true) that the receiver will use to compute bearing and heading measurements.



Press MNU and use the UP/DOWN ARROWs to highlight SETUP MENU and press ENTER. Use the UP/DOWN ARROWs to highlight NORTH REF and press ENTER.

Use the UP/DOWN ARROWs to select TRUE or MAGNETIC and press ENTER.

Default value: MAGNETIC

Selecting a Map Datum

Allows you to change the datum the receiver uses to compute position coordinates for the POSITION screen to match the datum used on a map or chart. Use the map "legend" to determine the datum required for the map or chart. If you are not using a map or chart or are unsure as to which datum to use, select WGS84.



Press MNU and use the UP/DOWN ARROWs to highlight SETUP MENU and press ENTER. Highlight MAP DATUM and press ENTER.

Use the UP/DOWN ARROWs to select the datum you wish, then press ENTER.

Default value: WGS84

See *Available Datums* for a complete list of available datums.

Selecting NMEA Format

The GPS 4000 XL can be set to output GPS data in any of three NMEA 0183 formats to interface with other marine devices or a personal computer.

Consult your autopilot, plotter or radar manual for instructions on connecting a GPS device and which NMEA format is required. The GPS 4000 XL supports the NMEA 0183 format with message sets of 0183A, 0183B, or 0183C. Refer to the *NMEA Data Message* section of this manual for the definition of the data messages. Also refer to *Selecting the Output Baud Rate*.



Press MNU and use the UP/DOWN ARROWs to highlight SETUP MENU and press ENTER. Use the UP/DOWN ARROWs to highlight NMEA and press ENTER.

Use the UP/DOWN ARROWs to select the the NMEA message set desired and press ENTER.

Default value: OFF



The Power/Data Module or the Power/Data/Antenna Module is required to connect the GPS 4000 XL to an external device. Either of these modules are available from Magellan Systems Accessories Order Department (909) 394-5000.

Selecting the Baud Rate

Connection to external devices requires that the baud rate that the data being sent or received by the GPS 4000 XL be matched to the baud rate of the external device. Check the documentation for your external device for the appropriate baud rate.



Press MNU and use the UP/DOWN ARROWs to highlight SETUP MENU and press ENTER. Use the UP/DOWN ARROWs to scroll to the second page. Highlight BAUD RATE and press ENTER.

Use the UP/DOWN ARROWs to select the required baud rate and press ENTER.

Default value: 4800 baud

Activating or Deactivating the 2nd Position Function

This function enables you to turn the 2ND POSITION screen on or off.



Press MNU and use the UP/DOWN ARROWs to highlight SETUP MENU and press ENTER. Use the UP/DOWN ARROWs to scroll to the second page of the SETUP MENU. Highlight 2ND POS SCR and press ENTER. Highlight ON or OFF and press ENTER.

Default: OFF

Changing Landmark Sorting Order

Landmark sort classifies the landmarks stored in the user landmark catalog in alphabetical order or according to their proximity to the present position with the closest listed first.



Press MNU and use the UP/DOWN ARROWs to highlight SETUP MENU and press ENTER. Use the UP/DOWN ARROWs to scroll to the second page. Highlight LMK SORT and press ENTER.

Use the UP/DOWN ARROWs to select ALPHABETIC or NEAREST, then press ENTER.

Default value: ALPHABETIC

Setting the Plotter Orientation

Plot Setup allows you to select the track orientation on the Plotter Screen from North Up or Track Up. When North up is selected, North is at the top of the display no matter which way you turn. When Track up is selected, your heading is at the top of the display and moves with you as you turn.



Default value: Plot Orientation — TRACK UP

Setting Plotter Track History



Press MNU and use the UP/DOWN ARROWs to highlight SETUP MENU and press ENTER. Use the UP/DOWN ARROWs to scroll to the second page. Highlight PLOT SETUP and press ENTER.

Use the UP/DOWN ARROWs to select PLOT ORIENT or TRACK HIST, then press ENTER.

After selecting TRACK HIST, you are given a choice of settings for the distances units used to represent the distance between points taken to plot the track history.

The track history creates a dot each time you cover the selected distance, displaying up to 48 connected dots, and then begins erasing the points first created.

Default value: Track History — 0.5 DIST

Setting Map Scale and Measurement Units

This function allows you to select the map scale and the unit of measure that will be used for map projection.

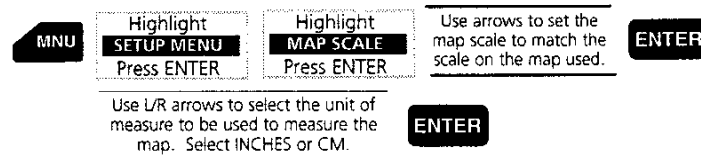

Press MNU and use the UP/DOWN ARROWs to highlight SETUP MENU and press ENTER. Use the UP/DOWN ARROWs to scroll to the second page. Highlight MAP SCALE and press ENTER.

Adjusting Screen Contrast

Used to adjust the contrast of the display.

Method 1. Press MNU and use the UP/DOWN ARROWs to highlight SETUP MENU and press ENTER. Use the UP/DOWN ARROWs to scroll to the second page. Highlight CONTRAST and press ENTER. Use the RIGHT/LEFT ARROWs to adjust contrast and press ENTER.



Method 2: From any NAV screen, press **ENTER** and select **CONTRAST**.
Use the **RIGHT/LEFT ARROW**s to adjust the contrast and press **ENTER**.

Using the Map Distance Tool (UTM Grids Only)

Using the GPS 4000 XL with UTM coordinates selected and a map also using UTM grids you can find the physical distance on the map (in inches or centimeters) between two landmarks. If you knew the location on the map of one of your saved landmarks you could then use **MAP DIST** to compute the distance on the map from a second saved landmark to assist in locating the second landmark on the map.

As in Map Projection, the GPS 4000 XL map scale must be set to match the scale of the map you are using. Refer to *Customizing the GPS 4000 XL, Setting Map Scale and Measurement Units*.

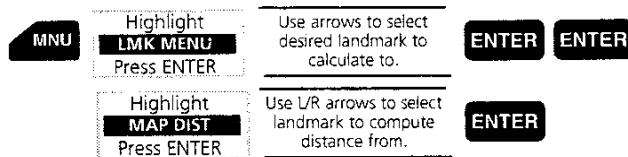

Press **MNU** and use the **UP/DOWN ARROW**s to select **LMK MENU** and press **ENTER**.

Select the landmark in the in the list you want to calculate the map distance and press **ENTER**. Press **ENTER** to access the subfunction menu, highlight **MAP DIST** and press **ENTER**.

Use the **LEFT/RIGHT ARROW**s and press **ENTER** to selection the landmark from which to measure. The default is the last position fix taken, however you may change this value in order to measure the distance between any two landmarks in memory. (The computed data is valid for UTM grids only.)



Viewing the Status of Available Satellites

Viewing the SAI STATUS Screen

This screen provides you with the signal strength of each satellite being tracked and its relative position in the sky.



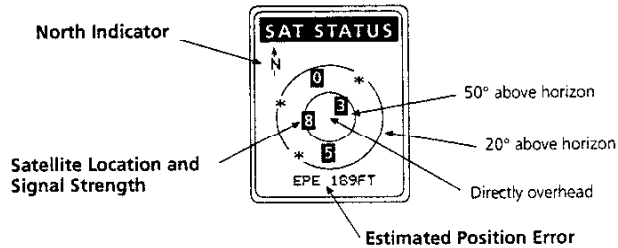

- * Signal not being received
- 0-2 Weak signal strength.
- 3-6 Average signal strength.
- 7-9 Strong signal. Provides best possible signal strength for position fixes.

Simulating Navigation with the GPS 4000 XL

Turning the Simulation Mode On

The Simulate Mode allows you to view the navigation displays with an "active" route, and then practice entering landmarks and modifying your route. The receiver must be initialized to access this feature.

Press MNU and use the UP/DOWN ARROWs to highlight SIMULATOR and press ENTER.

The message "ACTIVATED PRESS NAV KEY" appears.

Press NAV to return to the POSITION screen. The receiver begins navigating, using your initial position fix to project landmarks and create a multileg route appearing as ROUTE 5 in the route menu.



 If route 5 is occupied when SIMULATE is selected, SIMULATE automatically uses the existing Route 5 for simulation.

To Deactivate Simulator, follow the same steps: press MNU and use the UP/DOWN ARROWS to highlight SIMULATOR and press ENTER.

The message "DEACTIVATED CHK INITIAL POSITION" appears.

Also, when the receiver is turned off, the Simulator is automatically deactivated.

When SIMULATOR is deactivated, the temporary route it created is automatically deleted from the route menu. If a user defined route was used, it will remain intact.

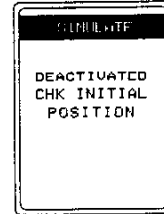

During the simulation, the GPS 4000 XL position will change as the unit navigates toward landmarks on the simulated course. After deactivating SIMULATE, be sure to obtain a new position fix before using the receiver for position or navigation information.

Icons

The bottom row of the display has been reserved for displaying icons that assist you in determining the operating status of the GPS 4000 XL.

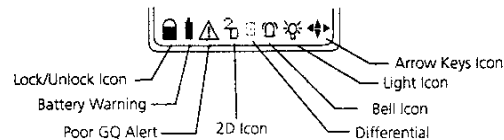

Lock/Unlock Icon. Provides a visual indication of whether the receiver is “locked” or “unlocked” on satellite signals.



GPS 4000 XL is locked onto satellite signals; computing fixes.

GPS 4000 XL has low signal strength on the satellites it is tracking. Move the receiver so that it has a better view of the sky.

GPS 4000 XL is not locked onto enough satellites to compute a fix. Move the receiver so that it has a better view of the sky. (Also appears in SIMULATE mode.)



Battery Warning. When this icon first appears, the receiver will operate for an additional 30 minutes before automatically turning off.

NOTE: The GPS 4000 XL will retain its memory (route, landmarks, last fixes, etc.) for a minimum of 20 minutes with the batteries removed. Memory will be retained with low batteries for approximately one month if the unit is turned off.



Poor GQ Alert. When this icon appears, the geometric quality (GQ) of the satellites is poor. Try to move away from any large obstructions that may be blocking reception of satellite signals.



2D Icon. Is displayed when the receiver is in 2D mode and has computed a position fix. Also displayed when in 3D mode and there are not enough satellites to compute a 3D position fix.



Differential. Indicates that the receiver is utilizing DGPS to compute position fixes. Requires an additional DGPS receiver.



Bell Icon. Appears when you navigating on a route or GO TO and you are approaching (within 0.2 distance units) a destination landmark that has an attached message.



Light Icon. Is displayed when the LCD backlight has been turned on with the LIGHT key. The backlight will cause the batteries to run down much quicker and should be turned off when not needed.



Arrow Key Icon. Provides a visual indication as to which arrow keys are active for the displayed screen.

Warnings and Other Messages

DUPLICATE
LANDMARK
NAME

You have attempted to assign a landmark name that has already been used. Every landmark must have a unique name.

Press CLR and assign a different name to the landmark.

NO FIXES
SAVED

You have attempted to view the Last Fix List without having any fixes in the last fix buffer.

Press NAV and position the receiver to collect satellite signals to compute a position fix. The receiver will create a last fix after a position fix is computed and will continue to create a last fix every 10 minutes thereafter.

MORE FIXES
NEEDED
TO CONTINUE

You have attempted to set a GO TO Backtrack without a sufficient number of last fixes to create the backtrack.

Position the receiver to collect satellite signals to compute a fixes. The receiver will create a last fix after a position fix is computed and will continue to create a last fix every 10 minutes thereafter.

LANDMARK
USED
IN ROUTE
OR GOTO

You have tried to clear a landmark that is currently used in a route, or a landmark that is the destination of your current GO TO.

If the landmark is in a route, delete the route from the Route Menu. If the landmark is the destination of a GO TO route, select a new GO TO route.

SAT STATUS
INITIALIZE
POSITION

You have tried to view the SAT STATUS screen when the receiver has not been initialized.

Refer to the section on Initializing the Receiver and enter your initial coordinates.



You have tried to set a GO TO or Backtrack route without enough empty spaces in the landmark list to create the temporary landmarks that GO TO and Backtrack require.

Access the Landmark Menu from the MNU key. Select landmarks that you no longer need and clear them from memory. If you were trying to set a GO TO route, you will need to clear only one landmark. For a Backtrack, you may have to clear several landmarks to create enough space for the Backtrack temporary landmarks.



You have attempted to set a Route without having saved any landmarks.

Enter one or more landmarks before attempting to set a route.

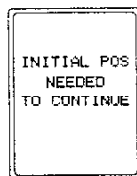

You have pressed the GO TO key before the receiver has been initialized.

Initialize the receiver to continue.



Some coordinate systems require that a specific datum be used (i.e., OSGB coordinates can only be used with the GRB36 datum.) This warning is presented when you attempt to change the map datum while using a coordinate system that has a required datum.

Note: The GPS 4000 XL automatically selects the required datum when setting the coordinate system to one with a specific datum.

Change the coordinate system before attempting to change the map datum.



Troubleshooting

The following is a brief guide to some of the problems that might be encountered while using a GPS satellite receiver and what you can do to correct them.

Receiver will not turn on

- 1 Check to see if the batteries are installed correctly
- 2 Replace the batteries with four new alkaline AA batteries.
- 3 Press power key and hold for 5 seconds.

Receiver will not compute a position fix or is losing lock (lock icon is open)

- 1 Make sure that you have a clear and unobstructed view of the sky and that your hand and other items are not covering the antenna. Hold the receiver at a comfortable arm's length away from you body so that your body doesn't act as a shield to the signals from the satellites.
- 2 Have you moved over 300 miles with the receiver off since your last position fix? If so, the receiver may need to be reinitialized.
- 3 Check Sat Status to see where the satellites are and if the receiver is acquiring data.
- 4 Check date and time on the POSITION screen.



Elevation jumps up and down

- 1 Errors induced by the Department of Defense called Selective Availability (SA) can cause the elevation values to fluctuate.

GQ icon (⊗) is displayed and stays on.



- 1 Make sure that you have a clear, unobstructed view of the sky and that your hand and other items are not covering the antenna. Hold the receiver at a comfortable arms length away from your body so that your body doesn't act as a shield from the satellite signals.
- 2 Check Sat Status to see where the satellites are and if the receiver is acquiring data.

Battery life seems shorter than it should be

- 1 Make sure that you are using quality AA Alkaline batteries. Magellan System recommends Eveready Energizers™ for use in the GPS 4000 XL.
- 2 Shorter life span of the batteries can be due to excessive use of the backlight. *Turn the backlight off when not needed.*

Position coordinates on your receiver do not match the location on your map.

- 1 Make sure that your receiver is set up to use the same datum as your map. The map datum is generally shown in the map legend. See Map Datum under Setup for instructions on selecting the map datum in your receiver.

- 
- 
- 
- 2 Check your LAT/LON format. Make sure that the format selected in COORDINATE SYSTEM (DEG/MIN/SEC or DEG/MIN.MM) is in the same format as the map you are using.

When All Else Fails...Contacting Customer Service

The previous list should allow you to solve most of the operating problems you are likely to encounter, if the receiver still appears to be operating improperly there are two other steps that may clear the problem. Simply disconnecting the unit from power for a moment may solve your problem. If this does not help, try clearing the receiver's memory in the CLEAR MENU and reinitializing your receiver. Be cautious before doing this as this will cause you to lose all of the landmarks and routes that you have input into the receiver.

If you are unable to solve your operation problems, please call Magellan's Customer Service at 909-394-5000. Representatives are available Monday through Friday, from 7 A.M. to 5 P.M., Pacific Standard Time. Faxes can be sent to Customer Service at 909-394-7050.

If necessary, you can also return your unit to Magellan for repair. (Please call for assistance first.) If possible, please notify us before shipping the unit by Parcel Post or UPS, and include with the unit a description of the problem and your name and address. If your return shipping address is different, please include it.

It is necessary to return the enclosed warranty card in order to activate the warranty.

With all correspondence, please be sure to state the model of the receiver you have and if calling, please be sure to have your unit with you.

Packages should be sent to:

Magellan Systems Corporation
960 Overland Court
San Dimas, CA 91773
Attn.: Warranty/Repair

Connecting External Power/Devices

The GPS 4000 XL requires the Power/Data Module or the Power/Data/Antenna Module to use external power with the receiver.

To use the module, remove the batteries from the compartment on the bottom of the receiver and insert the module in their place as shown.

A six-foot cable is provided to connect the receiver to an external 9 – 16 VDC power source. The yellow and orange wires are used to connect the GPS 4000 XL to an external device.

The module shown below is the Power/Data Module which does not have the capability to connect a remote antenna.

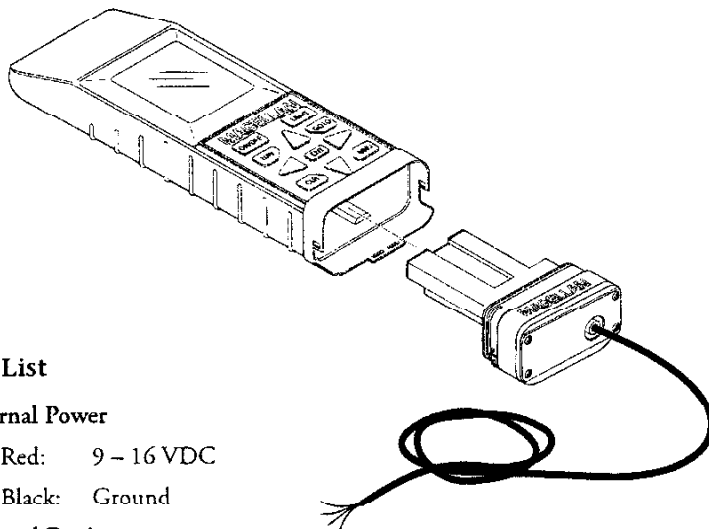

Wiring List

External Power

Red: 9 – 16 VDC

Black: Ground

External Device

Yellow: Data or NMEA Out

Orange: Data In

Connecting to an External Antenna

The GPS 4000 XL requires the Power/Data/Antenna Module to use an external antenna with the receiver.

To use the module, remove the batteries from the compartment on the bottom of the receiver and insert the module in their place as shown.

The module shown here is the Power/Data/Antenna Module which not only serves as the interface for the remote antenna but can also be used for connecting external power and external devices.

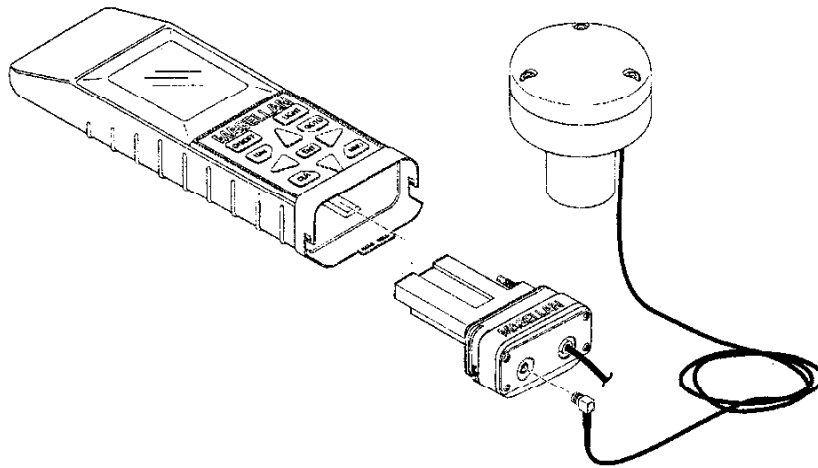

The antenna can be permanently mounted on a flat surface, to an antenna mast (threaded pole), or an option magnetic mount may be purchased from Magellan Accessories Department enabling the antenna to be attached to any flat, metallic surface. Instructions for mounting the antenna are supplied with the Power/Data/Antenna Module kit.



Uploading/Downloading Landmark Data

Using the optional GPS 4000 XL PC Module you will have the capability of downloading to an IBM-compatible computer all of the landmark, route, and almanac information stored in your receiver.

After downloading the information you can:

- Edit existing landmarks
- Create new landmarks
- Delete landmarks
- Edit existing routes
- Create new routes
- Delete routes

and much, much more.

With the Magellan software you can store the data as a backup file, create separate data files for different uses, or just use the PC-driven software as a more familiar method of modifying the data.

The modified data can then be uploaded back into your GPS 4000 XL receiver and it is ready to go.

The GPS 4000 XL PC Module comes complete with a docking station that fits into the GPS 4000 XL just like the Power/Data/Antenna Module shown on the previous page, a built-in data cable with a 9 pin connector that plugs into your computer serial port, AC power transformer that supplies DC power to the receiver and an instruction manual.



The module comes with a DB-9 connector attached. Some serial ports require a DB-25 connector so an adapter will be required to connect the cable to the computer. These DB-9 to DB-25 adapters can be purchased from any electronics/computer parts dealer.

Swivel Mounting Bracket (Optional)

The Swivel Mounting Bracket is an optional accessory to the Magellan GPS 4000 XL that you may order from Customer Service or your dealer. This bracket, when permanently attached to a vertical or horizontal surface, provides a convenient holder for the GPS 4000 XL. The GPS 4000 XL can be inserted and removed easily from the Swivel Mounting Bracket.

Contents

The Magellan GPS 4000 XL Swivel Mounting Bracket comes with the following parts:

- Holding cradle
- Rectangular mounting plate
- 2 1/4" Swivel screw
- Round swivel base
- 1" Swivel base nut
- Rectangular mounting plate

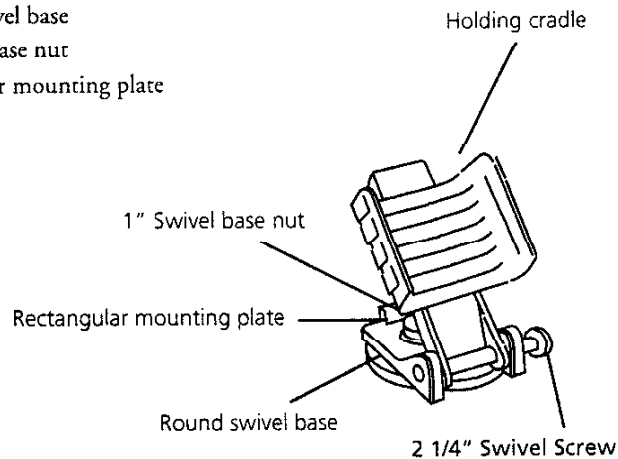

To install on a dash board or other horizontal surface

Secure the round swivel base to the dash board or other surface using the four screw holes.

Attach the rectangular mounting plate to the round swivel base using the 1" swivel base nut through the center holes of both pieces.

Adjust the swivel base nut to allow or restrict swivel movement, as desired.

Attach the holding cradle to the mounting plate by aligning the swivel screw holes of the holding cradle between those of the mounting plate. Apply gentle pressure to snap into place, and insert the 2 1/4" swivel screw from right to left.



Be sure to seat the receiver properly by ensuring that both sides are secure in the bracket. You should hear two “snaps” when the receiver is fitted into the bracket correctly.

To install as a wall-mount:

Secure the rectangular mounting plate to the wall using the four screw holes, with the tab facing upwards and the two swivel screw holes downwards.

Attach the holding cradle to the mounting plate by inserting the tab of the mounting plate into the slot on the back of the holding cradle.

Gently force the bottom portion into place to align the swivel screw holes of the holding cradle with those of the mounting plate, then insert the swivel screw from right to left.

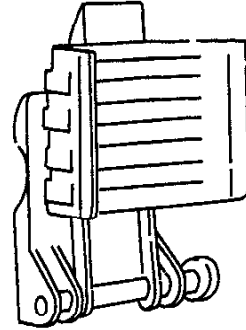

Wall Mount Configuration



When the unit is installed on a wall, the round swivel base and 1” swivel base nut are not used. Store in box for future use.

The GPS 4000 XL can be snapped easily into and out of its holding cradle.

When removing the unit from its cradle, simply pull the sides of the cradle gently apart and press fingers from behind until the unit is freed.

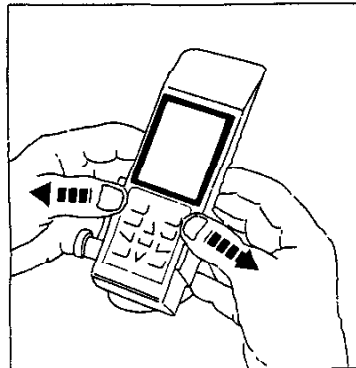

Removing the GPS 4000 XL from the Swivel Mounting Base

NMEA Data Messages

Data Transfer

Your GPS receiver can be set to output GPS data in the NMEA 0183 format to interface with other marine devices.

To output NMEA data the dataport must be turned on by selecting an output message format (0183A, 0183B, or 0183C) from the NMEA Setup function.

NMEA Data Messages. NMEA data is output at 4800 baud, 8, N, 1, checksum off. These settings are acceptable to most equipment and software applications.

There are several NMEA output message sets, each with a slightly different application. Check the documentation for your external equipment to select the appropriate message set.

SET	OUTPUT/USAGE
0183A	BWC, APA, GLL, VTG Remote displays, version 1.x marine autopilots
0183B	RMC, RMB NMEA-recommended navigation data for remote map, etc.
0183C	APB, GGA, BWC, GLL, VTG Version 2.0 marine autopilot data and satellite data

NMEA Message Definitions

APA	Autopilot cross track error, direction to steer, status of GPS, route status, destination landmark name, and bearing from origin to destination (old format).
APB	Revised autopilot message contains all of the above plus: heading to steer toward destination, bearing from the present position to the destination (magnetic or true).
BWC	Range and bearing to a landmark
GGA	GPS position, time, fix quality, number of satellites used, HDOP (Horizontal Dilution of Precision), differential reference information, and age.
GLL	GPS-derived latitude, longitude, and time of fix.
RMB	Data status, cross track error, direction to steer, origin, destination landmark, landmark location, bearing to destination, and velocity toward the destination.
RMC	Time, latitude, longitude, speed over ground, course over ground, and date.
VTG	Track (magnetic and true) and groundspeed (knots and KPH).

OUTPUT DATA FORMAT

APA Autopilot Format A

1 2 3 4 5 6 7 8 9 10
APA,A,A,X.XX,L,N,A,A,XXX.,M,CCC

- 1 OR'ed Blink and SNR (A = valid, V = invalid)
- 2 Cycle Lock (A = valid, V = invalid)
- 3-5 Cross Track, Sense (L = steer left, R = steer Right), N.Mi. Units
- 6-7 Arrival Circle, Arrival Perpendicular (crossing of the line which is perpendicular to the course line and which passes through the destination landmark.
- 8-9 Bearing dest. LMK. from origin LMK., Magnetic
- 10 Dest LMK. identifier

APB Autopilot Sentence "B"

1 2 3 4 5 6 7 8 9 10 11 12 13 14
APB,A,A,x.x,a,N,A,A,x.x,a,C-C,x.x,a,x.x,a*hh

- 1 Status: V = Loran-C Blink or SNR warning
A = general warning flag for other navigation systems when a reliable fix is not available.
- 2 Status: V = Loran-C cycle lock warning flag
A = OK or not used
- 3 Magnitude of XTE
- 4 Direction to steer (L, R)
- 5 XTE units, nautical miles
- 6 Status: A = arrival circle entered
- 7 Status: A = perpendicular passed at landmark
- 8-9 Bearing origin to destination, M/T
- 10 Destination landmark ID
- 11-12 Bearing, present position to destination, Magnetic or True
- 13-14 Heading to steer to destination landmark, Magnetic or True

BWC To Selected Landmark, Great Circle

1 2 3 4 5 6 7 8 9 10 11 12
BWC, XXXXXX, XXXX.XX, N, XXXXX.XX, W, XXX., T, XXX., M, XXX.X, N, CCCC

- 1 UTC of Bearing
- 2-3 Lat, N or S of landmark
- 4-5 Long, E or W of landmark
- 6-7 Bearing, True
- 8-9 Bearing, Magnetic
- 10-11 Distance, naut. miles
- 12 Landmark identifier

GGA Global Positioning System Fix Data

1 2 3 4 5 6 7 8 9 10 11
GGA, hhmmss.ss, 111.11, a, yyyyy.yy, a, x, xx, x.x, x.x, M, x.x,
1213 14
M, x.x, xxxxx*hh

- 1 UTC of Position
- 2-3 Latitude - N/S
- 4-5 Longitude - E/W
- 6 GPS Quality Indicator
 - 0 = fix not available or invalid
 - 1 = GPS Fix
 - 2 = Differential GPS Fix
- 7 Number of satellites in use
- 8 Horizontal dilution of precision
- 9 Antenna altitude above/below mean sea level
- 10 Units of antenna altitude
- 11 Geoidal separation - difference between the WGS-84 earth ellipsoid and mean sea level (geoid), "-" = mean sea level below ellipsoid
- 12 Units of geoidal separation, meters.
- 13 Age of Differential GPS data - Time in seconds since last SC104 Type 1 or 9 update, null field when DGPS is not used
- 14 Differential reference station ID, 0000-1023

GLL Geographic Position — Latitude/Longitude

1 2 3 4 5 6
GLL,1111.11,a,yyyyy.yy,a,hmmss.ss,A*hh

- 1-2 Latitude, N/S
- 2-3 Longitude, E/W
- 4 UTC of position
- 6 Status A = Data valid

RMB Generic Navigation Information (immediately follows RMC)

1 2 3 4 5 6 7 8 9 10 11 12
RMB,A,X.XX,L,CCCC,CCCC,SSS.SS,N,XXXXX.XX,W,XXX.X,XXX.,XX.X,

13 14
A *XX

- 1 Status (A = valid, V = invalid)
- 2-3 XTE, naut. miles and direction to steer (L or R) [If XTE exceeds 9.99 NM, display 9.99 in field 2.]
- 4 Origin landmark ID
- 5 Destination landmark ID
- 6-7 Destination Landmark Latitude (N or S)
- 8-9 Destination Landmark Longitude (E or W)
- 10 Range naut. miles, present fix to destination landmark Great Circle. [If range exceeds 999.9 nm, display 999.9.]
- 11 Bearing, True, Great Circle, Present fix to dest. landmark
- 12 Closing velocity to destination, knots
- 13 Arrival (OR'ed arrival circle and crossing of line which is perpendicular to the course line and which passes through the destination landmark.)
- 14 CHECKSUM (Mandatory in this sentence.)

RMC Transit Specific (to be followed by RMB)

1 2 3 4 5 6 7 8 9 10
12
RMC,XXXXXX,A,XXXX.XX,N,XXXXX.XX,W,XX.X,XXX.,XXXXXX,XX.,E
*XX

- 1 Time, UTC
- 2 Status (A = valid, V = invalid)
- 3-4 Latitude at UTC time, N or S
- 5-6 Longitude at UTC time, E or W
- 7 Speed over ground, knots
- 8 COG (track), degrees
- 9 Date (DDMMYY)
- 10 Variation, degrees
- 11 Variation, sense (E or W)
- 12 CHECKSUM (Mandatory in this sentence)

VTG Actual Track and Ground Speed (SOG)

1 2 3 4 5 6 7 8
VTG,XXX.,T,XXX.,M,XX.X,N,XX.X,K

- 1-2 Track degrees, True
- 3-4 Track degrees, Magnetic
- 5-6 Speed, knots
- 7-8 Speed, kilometers/hour

The formats listed are NMEA formats and Magellan receivers may not output all of the information listed for a particular format.

A complete copy of the NMEA specifications can be obtained from:

NMEA
P.O. Box 3435
New Bern, NC 28564-3435
(919) 638-2626

Available Datums

Datum	Full Name	Datum	Full Name
WGS84	World Geodetic System	IRELA	Ireland 1965
NAD27	North American 1927	KAUAI	Kauai
NAD83	North American 1983	KERTA	Kertau 1948
ADIND	Adinda	KKJ	KKJ (Finland)
ALASK	Alaska	LIBER	Liberia 1964
ARC50	Arc 1950	LUZON	Luzon
ARC60	Arc 1960	MASSA	Massawa
ASTRO	Camp Area Astro	MAUI	Maui
AUS66	Australian Geodetic 1966	MERCH	Merchich
AUS84	Australian Geodetic 1984	MINNA	Minna
BOGOT	Bogota Observatory	MONTJ	
BUKIT	Bukit Rimpah	NAHRW	Nahrwan, Saudi Arabia
CAMPO	Campo Inchauspe	OAHU	Oahu
CANAD	Canada	OEGYP	Old Egyptian
CAPE	Cape	OHAWA	Old Hawaiian
CARTH	Carthage	OMAN	Oman
CENAM	Central America	PITCA	Pitcairn Astro 1967
CHATH	Chatham 1971	QATAR	Qatar National
CHUAA	Chau Astro	QORNO	Qornoq
CORRE	Corrego Alegre	RT90	Rt90 (Sweden)
CYPRU	Cyprus	SAM56	Provisional So. Am. 1956
DJAKA	Djakarta (Batavia)	SAM69	South American 1969
EGYPT	Egypt	SCHWA	Schwarzeck
EUROP	European 1950 (All of Europe)	SICIL	Sicily
EUR50	European 1950 (W. Europe)	SIERR	
EUR79	European 1979	SWISS	
GANDA	Gandajika Base	TANAN	Tananarive Observatory
GEO49	Geodetic Datum 1949	1925	
GHANA		THAI	Indian (Thailand, Vietnam)
GRB36	Ordnance Survey of GB, 1936	TIMBA	Timbalai
GUAM	Guam	TOKYO	Tokyo
GUNSG	G. Segara	USER DEFINED	
GUNSR		VOIRO	
HAWAI	Hawaii	WGS72	World Geodetic System 1972
HERAT	Herat North	YACAR	Yacare
HJORS	Hjorsey 1955	ZANDE	Zanderij
HUTZU	Hu-tzu-shan		
INDIA	Indian (India, Nepal)		
IRAN	Iran		

Specifications

CHARACTERISTICS

Performance

Receiver AllView 12 Technology, tracks up to 12 satellites to compute and update position information

Acquisition Times (under optimal conditions):

Warm Approximately 35 seconds

Cold Approximately 3–5 minutes

Update Rate 1 second continuous

Accuracy:

Position 49 feet (15 meters) RMS (with Selective Availability turned off).

Velocity 0.1 knot RMS steady state (with Selective Availability turned off).

Limits

Speed 951 mph

Altitude 17,500 meters

Physical

Size 6.6" x 2.3" x 1.3" [h] x [w] x [d]
16.7 cm x 5.8 cm x 3.3 cm

Weight 10 ounces (283 grams) with
4 AA batteries installed

Display 1.8" x 1.4" [h] x [w]
4.6 cm x 3.6 cm
high contrast LCD with backlighting

Housing Waterproof construction

Temp. Range:

Operating 14°F to 140°F (-10°C to 60°C)

Storage -40°F to 167°F (-40°C to 75°C)

Power

Source 4 AA alkaline batteries or
10–16 VDC with optional external power/data module

Battery Life Up to 24 hours continuous operation

Current Drain 80 mA without light, 145 mA with light

Coordinate Systems

Positions are locations that are described in a unique way so that one location cannot be confused with another. This is done by using a coordinate system to describe locations. Your Magellan receiver has the ability to use any one of eight different coordinate systems; LAT/LON (latitude and longitude), UTM (Universal Transverse Mercator), OSGB, Irish Grid, Swedish Grid, Swiss Grid, Finnish Grid or User Grid. The one you select (in SETUP) will be determined by the maps and charts you use; you would generally want the receiver to display position coordinates in the same system that is used by your maps.

LAT/LON Coordinate System. LAT/LON is the most commonly used coordinate system today. It projects lines of latitude (parallels) and lines of longitude (meridians) onto the earth's surface. Lines of latitude are the equator and the horizontal lines that are parallel to it. Lines of longitude are the vertical lines that are perpendicular to the equator and pass through the poles. A position is described as being the intersection of a line of latitude and a line of longitude.

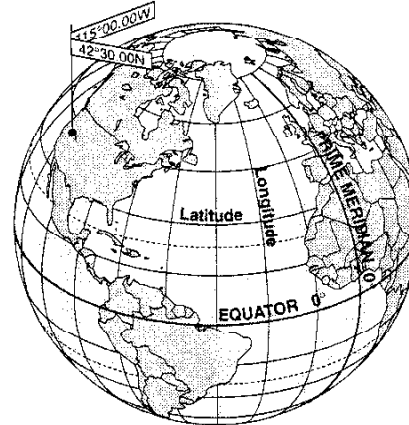

Specifically, a position is up to 90 degrees north or south of the equator (up to the poles, which are 90°N and 90°S; the equator is 0° latitude), and up to 180 degrees east or west of the Prime Meridian, which is 0° longitude. (The Prime Meridian passes through Greenwich, England.) Parts of a degree are minutes; there are 60 minutes (written as 60') to a degree. Minutes can also be divided into smaller units. Fractions of a minute can be expressed as decimals or as seconds. (There are 60 seconds to one minute, written as 60"). So a Lat/Lon position coordinate can be expressed in two ways, which your Magellan GPS receiver displays as 25°47.50 or 25°47'30.

UTM Coordinate System. Another commonly used coordinate system is UTM (Universal Transverse Mercator), which is generally found on land-based maps and quad sheets that are produced by government map providers. On land, you may find that UTM coordinates are easier to use than Lat/Lon.

UTM coordinates are easy to use, but since the model it is based on is somewhat abstract, this section is a very simplified introduction to UTM.

Instead of projecting an imaginary grid of intersecting lines onto the globe, UTM projects sections of the globe onto a flat surface. Each of these sections is



called a "zone." There are 60 zones to cover the entire earth between 84°N and 80°S (polar areas are not described by UTM). Each zone is 6° wide as projected from the earth's center.

A UTM position is described by three elements; the zone it is in, the easting, and the northing. Eastings and northings measure how far into a zone a position is in meters. Eastings are an east/west measurement, and correspond roughly to longitude. Northings are a north/south measurement, and correspond to latitude.

This chart shows the position of Magellan Systems described in both Lat/Lon and UTM coordinates.

LAT/LON		UTM
DEG/MIN.MM	DEG/MIN/SEC	
34°06.58N	34°06'35"N	11 4 23 818 E 37 74 624 N
117°49.56W	117°49'34"W	

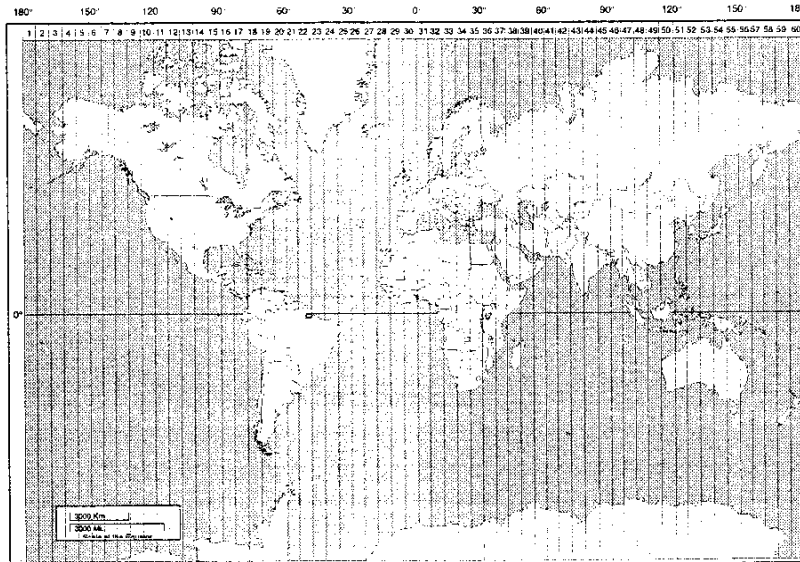

NOTE: The area described by the UTM coordinate system extends to 84°N and to 80°S.

Other Coordinate Systems. OSGB coordinates are similar to UTM's, but describe only Great Britain. They must be used with the GBR36 datum. This coordinate system cannot be used in any other part of the world. The GPS 4000 XL automatically selects the GBR36 datum when the OSGB coordinate system is selected in Setup. (While OSGB coordinates must be used with the GBR36 datum, the GBR36 datum can be used with LAT/LON coordinates; just be sure the map you are using uses both LAT/LON and GBR36.)



If you select OSGB in the COORD SYS portion of the Setup Menu be sure to change the map datum back to the one you will be using (WGS84 is the default) when changing to another coordinate system.

Irish Grid uses the Ireland datum, Finnish Grid uses KKJ datum; Swedish Grid uses the RT90 datum, and Swiss Grid uses the Swiss datum. Under USER DATUM you may also use another datum you are familiar with (but which is not listed).

User Grids

If you prefer, you can enter and save a user-entered grid. User-entered grids are non-standard grids that are used in relatively small operational areas, in areas where grid systems are locally prescribed, and in areas that are not directly supported by any of the built-in coordinate systems. A user-defined grid can also be used to increase the accuracy of position data that is collected in an area that is more accurately described by a local grid. The user-defined grid utility can also be used to input State Plane Coordinate Systems.

A number of options are available when entering a user-defined grid. Refer as necessary to the following table while entering a grid.

Mapping Function	Options	Origin	Scale	Local Units of Measure	False Coordinates
Transverse Mercator	Any	Not at Poles	Always Near 1.0	Units to Meters - All input and display of these coordinates will be in these units of measure.	In local units of measure as previously defined.
Lambert Conical	2 Standard Parallel				
	1 Standard Parallel				
Stereographic	N. Polar	North Pole			
	S. Polar	South Pole			
	Polar - scale at input Parallel	Either Pole			
	Oblique	Not at Equator			
Oblique Mercator	Equatorial	Not at Poles			
	Point - Azimuth	Any			
	Two - Point	- Lat 1 not at equator - Lat 1 ≠ Lat 2 - Lat 1 & Lat 2 in same hemisphere			
Polyconic	Any	Any			

User-Defined Grid Table



To enter a user-defined grid, access **COORD SYSTEM** in Setup and use the **UP/DOWN ARROW**s to scroll through the coordinate systems. Stop when **USER GRID** is displayed and press **ENTER**.

Use the **UP/DOWN ARROW**s to select the mapping function or projection (transverse mercator, lambert conical, stereographic, oblique mercator or polyconic.)

Press **ENTER** when the desired function/projection is highlighted, then use the chart.

Key in the grid's latitude and longitude of origin, using the **UP/DOWN ARROW**s. Press **ENTER**.



The unit will not accept an entry that is inappropriate for the entries already made. An attempt to enter an inappropriate option or origin will cause the unit to display "INVALID INPUT".

Key in a scale factor. The scale factor is normally a number that is close to 1. Press **ENTER**, then key in a units-to-meters conversion factor for all subsequent displays in this coordinate system. Press **ENTER**.

Key in a false easting, followed by **ENTER**, then a false northing followed by **ENTER**. (These entries are required to avoid displaying negative coordinates.)



What is GPS?

GPS is a constellation of navigation satellites that orbit the earth. The precise time and position information transmitted by these satellites is used by a GPS receiver to compute a position fix.

The system is now officially declared "operational," and provides continuous, 24-hour 3D (position plus elevation) coverage anywhere on the earth.

GPS was developed by the United States Department of Defense to provide consistent, reliable navigation information that is unaffected by rough terrain and bad weather, and is highly resistant to multipath errors and interference. The DoD continues to administer and control the Global Positioning System.

Although GPS was developed as a military navigation system, its civilian and commercial uses were recognized. The satellites therefore transmit two codes, a military-only encrypted code (PPS) and a civilian-access, Standard Positioning Service (SPS) code. All commercial and consumer GPS receivers are SPS receivers.

How Does GPS Work?

Each GPS satellite transmits its precise location (position and elevation) and the start time of the transmission. A GPS receiver acquires the signal, then measures the interval between transmission and receipt of the signal to

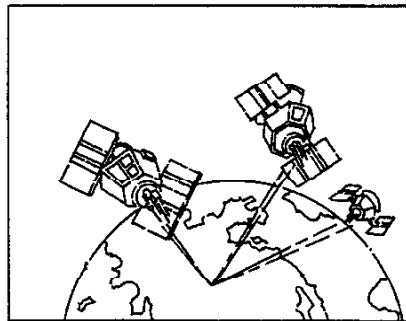

determine the distance between the receiver and the satellite: this is ranging. Once the receiver has computed range for at least three satellites, its location on the surface of the earth can be determined.

Every satellite transmits two types of data, almanac and ephemeris. Almanac data is general information on the location and health of each satellite in the constellation. Since it contains general information, an almanac can be collected from any satellite. A receiver with a current almanac in its memory knows where in the sky to look for satellites, given its last known position and the time of day. Ephemeris data is the precise satellite positioning information that is used for ranging. Each satellite transmits its own ephemeris data.

Both almanac and ephemeris data are required for a GPS receiver to locate and acquire satellites quickly and compute a position fix. Your Magellan receiver copies these messages automatically.



Accuracy

GPS positioning with an SPS receiver that is intended for general use will produce an accuracy of 25 meters or better.

In fact, SPS receivers have proven to be far more accurate than anyone anticipated. DoD has decided that 25-meter accuracy is a potential risk, and has introduced Selective Availability (SA) to maintain a military advantage. SA is a random error that is introduced to the SPS code ephemeris and timing data and reduces the accuracy of any SPS receiver. The size of the error changes, but rarely exceeds 100 meters.

The DoD civil GPS user policy is that GPS accuracy as affected by SA is sufficient for general navigation. In an open environment, it usually is. Even with SA, a GPS receiver will bring you within visual range of a destination or target, and GPS remains the best available source of accurate, reliable navigation and positioning information.

DGPS



Differential GPS (DGPS) computes the size of the error and applies it to positioning information. There are several ways to perform DGPS, one of which is broadcast differential. Broadcast differential uses GPS receivers at control sites to measure the range errors for all visible satellites and determines a correction for each satellite. These corrections are broadcast in the RTCM SC-104 format by a radio beacon at the control site to any differential beacon receiver that is within range of the signal.



The differential beacon receiver receives and demodulates the signal, then relays it to the user's differential-ready GPS receiver. The user's GPS receiver applies the corrections to the positioning information it collects to compute differentially corrected position and navigation data.

This technique requires that your GPS receiver be connected to a compatible differential beacon receiver (such as the Magellan DBR™, which is compatible with all differential-ready Magellan receivers). You must also be within range of a differential radio beacon.



Where to Get More Information

There are many sources for more information on GPS and navigation. The sources listed here are just a few of the books, magazines, and Internet addresses that deal with GPS. Your local library is a good source for technical books on GPS and navigation.

GPS Information Center

The GPS Information Center provides general information on the Global Positioning System and satellite status. This center is operated by U.S. Coast Guard for the Department of Transportation, and was established to provide information and to serve as a point of contact for civilian GPS users.

- Voice telephone recording for constellation status: (703) 313-5907
- Computer bulletin board: (703) 313-5910 (up to 14,400 bps) (8 data bits, 1 stop bit, no parity)
- 24 hour operator: (703) 313-5900; fax: (703) 313-5920



The GPS Information Center can NOT answer questions regarding the GPS 4000 XL. Please contact Magellan Customer Service at (909) 394-5000 for questions or assistance with using your receiver.

A Comprehensive Guide to Land Navigation with GPS

An excellent book written by Noel J. Hotchkiss and published by Alexis Publishing. ISBN No: 0-9641273-2-6. This book uses the Magellan GPS 4000 to discuss and describe land navigation with a GPS receiver. The book is very easy to read and gets into detail the art of navigating with GPS. (Available from Navtech Seminars.)

Newsgroups (Internet)

Several USENET newsgroups have occasional postings related to GPS. Some of the more popular newsgroups for GPS are:

- sci.geo.satellite-nav
- rec.aviation.products
- rec.boats
- sci.space
- sci.space.news

GPS World Magazine

Monthly magazine covering a wide variety of uses for GPS receivers.

Avanstar Communications
859 Willamette Street
Eugene, Oregon 97401
U.S.A.

Phone: (503) 343-1200
Subscriptions: 1-800-346-0085 x363

Other Books of Note:

Hofmann-Wellenhof, B., H. Lichtenegger, and J. Collins (1994). *Global Positioning System, Theory and Practice*. 3rd Edition. Springer-Verlag. 326 pp.

Institute of Navigation, The (1980). *Global Positioning System. Vol. I. The Institute of Navigation (U.S.)*, 246 pp.

Institute of Navigation, The (1984). *Global Positioning System. Vol. II. The Institute of Navigation (U.S.)*, 257 pp.

Institute of Navigation, The (1986). *Global Positioning System. Vol. III. The Institute of Navigation (U.S.)*, 293 pp.

Institute of Navigation, The (1986). *Global Positioning System. Vol. IV. The Institute of Navigation (U.S.)*, 378 pp.

Logsdon, T. (1992). *Navstar Global Positioning System*. Van Nostrand Reinhold, New York, 249 pp.

These books and others not mentioned can be purchased from Navtech Book and Software Store (a division of Navtech Seminars, Inc.). They can be reached at:

2775 S. Quincy St. #610
Arlington, VA 22206-2204 U.S.A.

Phone: (800) 628-0885

(703) 931-0500

Fax: (703) 931-0503

Abbreviations

°M	Degrees Magnetic north	LON	Longitude
°T	Degrees True north	M	Meters
2D	Two-dimensional	MH	Miles per hour
3D	Three-dimensional	MI	Miles
BRG	Bearing	MIN	Minutes
CDI	Course deviation Indicator	MNU	MENU
CLR	CLEAR	MPH	Miles per hour
CTS	Course to steer	NAV	NAVIGATE
DEG	Degrees	NM	Nautical mile
DST	Distance	POS	Receiver-generated name for current position
FT	Feet	SA	Selective Availability
GPS	Global Positioning System	SEC	Seconds
GQ	Geometric Quality	SPD	Speed
HDG	Heading	-STRT	Receiver-generated name for first landmark in a route
KM	Kilometers	TTG	Time To Go
KH	Kilometers per hour	UTM	Universal Transverse Mercator
KPH	Kilometers per hour	UT	Universal Time
KT	Knots	VMG	Velocity made good
LAT	Latitude	XTE	Cross track error
LFIX	Last Fix		
LMK	Landmark		
LMKxxx	Receiver-generated landmark name		

City Reference Chart

Australia & SW Pacific

Adelaide, Australia	34°56.00	S	138°36.00	E
Alice Springs, N. Terr., Australia	23°42.00	S	133°52.00	E
Apia, W. Samoa	13°48.00	S	171°45.00	W
Auckland, New Zealand	36°55.00	S	174°47.00	W
Bourail, New Caledonia	21°34.00	S	165°29.00	E
Brisbane, Queensland, Australia	27°30.00	S	153°00.00	E
Canberra, A.C.T., Australia	35°18.00	S	149°08.00	E
Cooper Pedy, S. Australia	28°56.00	S	134°45.00	E
Dampier, W. Australia	20°45.00	S	116°48.00	E
Darwin, N. Terr., Australia	12°23.00	S	130°44.00	E
Derby, W. Australia	17°19.00	S	123°38.00	E
Honiara, Guadalcanal Solomon Is.	9°28.00	S	159°57.00	E
Iron Range, Queensland, Australia	12°39.00	S	143°13.00	E
Mount Isa, Queensland, Australia	20°50.00	S	139°29.00	E
Nadi, Vitti Levu Fiji	17°47.00	S	177°29.00	E
Newman, Mt. W. Australia	23°20.00	S	119°34.00	E
Ooldea, S. Australia	30°30.00	S	131°45.00	E
Perth, W. Australia	31°58.00	S	115°49.00	E
Port Moresby, Papua New Guinea	9°30.00	S	147°07.00	E
Rawlinna, W. Australia	31°00.00	S	125°21.00	E
Timaru, New Zealand	44°23.00	S	171°14.00	E
Townsville, Queensland, Australia	19°13.00	S	146°48.00	E

Asia

Bangalore, India	12°58.00	N	77°35.00	E
Bangkok, Thailand	13°44.00	N	100°30.00	E
Beijing, China	39°55.00	N	116°26.00	E
Bombay, India	18°56.00	N	72°51.00	E
Calcutta, India	22°30.00	N	88°20.00	E
Colombo, Sri Lanka	6°55.00	N	79°52.00	E
Delhi, India	28°40.00	N	77°14.00	E
Hanoi, Vietnam	21°01.00	N	105°52.00	E
Harbin, China	45°45.00	N	126°41.00	E
Ho Chi Minh City, Vietnam	10°46.00	N	106°43.00	E
Hong Kong	22°15.00	N	114°10.00	E
Islambad, Pakistan	33°40.00	N	73°08.00	E
Jakarta, Indonesia	6°08.00	S	106°45.00	E
Kagoshima, Japan	31°37.00	N	130°32.00	E
Kandla, India	23°03.00	N	70°11.00	E
Karachi, Pakistan	24°51.00	N	67°02.00	E
Kathmandu, Nepal	27°42.00	N	85°19.00	E
Kinabalu, Malaysia	6°03.00	S	116°32.00	E
Kota, Malaysia	2°33.00	N	102°10.00	E
Kuala Lumpur, Malaysia	3°08.00	N	101°42.00	E
Kunming, China	25°04.00	N	102°41.00	E
Malang, Indonesia	7°59.00	S	112°45.00	E
Mandalay, Burma	21°57.00	N	96°04.00	E
Nagpur, India	21°10.00	N	79°12.00	E
Padang, Indonesia	6°12.00	S	120°27.00	E
Paku, Indonesia	8°19.00	S	121°44.00	E
Pinang, Malaysia	5°30.00	N	100°28.00	E
Pontianak, Borneo	0°05.00	S	109°16.00	E
Rangoon, Burma	16°47.00	N	96°10.00	E
Sapporo, Japan	43°05.00	N	141°21.00	E
Seoul, S. Korea	37°30.00	N	127°00.00	E
Shanghai, China	31°06.00	N	121°22.00	E
Sorong, Indonesia	0°50.00	S	131°17.00	E
Surakarta, Indonesia	7°32.00	S	110°50.00	E
Tanahmerah, Indonesia	6°08.00	S	140°18.00	E
Taipei, Taiwan	25°05.00	N	121°32.00	E
Thimphu, Bhutan	27°32.00	N	89°43.00	E



Tokyo, Japan	35°40.00	N	139°45.00	E
Tonhil, Mongolia	46°19.00	N	93°54.00	E
Ulaanbaatar, Mongolia	47°54.00	N	106°52.00	E
Urümqi, China	43°43.00	N	87°38.00	E
Wuhan, China	30°35.00	N	114°19.00	E
Xi'an, China	34°16.00	N	108°54.00	E
Yumen, China	39°54.00	N	97°43.00	E

CIS

Anadyr, Russia	64°50.00	N	177°50.00	E
Arkhangel'sk, Russia	64°32.00	N	40°40.00	E
Ashkhabad, Turkmenistan	37°58.00	N	58°24.00	E
Baku, Azerbaijan	40°22.00	N	49°53.00	E
Balkhash, Kazakhstan	46°50.00	N	74°57.00	E
Barnaul, Russia	53°21.00	N	83°45.00	E
Chita, Russia	52°03.00	N	113°35.00	E
Gizhiga, Russia	62°00.00	N	160°34.00	E
Igarka, Russia	67°31.00	N	86°33.00	E
Inarigda, Russia	63°15.00	N	107°40.00	E
Kargasok, Russia	59°07.00	N	80°58.00	E
Khatanga, Russia	71°59.00	N	102°31.00	E
Kiev, Ukraine	50°25.00	N	30°30.00	E
Krasnodar, Ukraine	45°02.00	N	39°00.00	E
Magdagachi, Russia	53°27.00	N	125°44.00	E
Moscow, Russia	55°45.00	N	37°42.00	E
Okhotsk, Russia	59°20.00	N	143°15.00	E
Perm, Russia	58°01.00	N	56°10.00	E
Petropavlovsk, Russia	54°53.00	N	69°13.00	E
Riga, Latvia	56°40.00	N	106°10.00	E
Saratov, Russia	51°30.00	N	45°55.00	E
Tashkent, Uzbekistan	41°16.00	N	69°13.00	E
Tulun, Russia	54°32.00	N	100°35.00	E
Vanino, Russia	49°05.00	N	140°14.00	E
Vladivostok, Russia	43°09.00	N	131°53.00	E
Vorkuta, Russia	67°27.00	N	64°00.00	E
Yakutsk, Russia	62°10.00	N	129°50.00	E

Middle East

Al Kuwait, Kuwait	29°20.00	N	48°00.00	E
Ar Riyad, Saudi Arabia	24°39.00	N	46°46.00	E
Baghdad, Iraq	33°20.00	N	44°26.00	E
Bairi, Iraq	36°57.00	N	57°56.00	E
Halab, Syria	36°14.00	N	37°10.00	E
Herat, Afghanistan	34°20.00	N	62°12.00	E
Jerusalem, Israel	31°47.00	N	35°13.00	E
Kabul, Afghanistan	34°31.00	N	69°12.00	E
Mashhad, Iran	36°16.00	N	59°34.00	E
Nazwa, Oman	22°56.00	N	57°33.00	E
Salalah, Oman	17°00.00	N	54°04.00	E
San'a, Yemen	15°24.00	N	44°14.00	E
Shiraz, Iran	29°38.00	N	52°34.00	E
Tabriz, Iran	38°05.00	N	46°18.00	E
Tarim, S. Yemen	16°08.00	N	48°58.00	E
Tehran, Iran	35°40.00	N	51°26.00	E

Africa

Abidjan, Ivory Coast	5°19.00	N	4°01.00	W
Ad Dakhla, W. Sahara	23°43.00	N	15°57.00	W
Adis Abeba, Ethiopia	9°03.00	N	38°42.00	E
Algiers, Algeria	36°50.00	N	3°00.00	E
Antananarivo, Madagascar	18°52.00	S	47°30.00	E
Asmera, Ethiopia	15°20.00	N	38°58.00	E
Aswan, Egypt	24°05.00	N	32°56.00	E
Bamako, Mali	12°40.00	N	7°59.00	W
Banghazi, Libya	32°07.00	N	20°04.00	E

Magellan GPS 4000 XL Satellite Receiver





Bangui, Central African Republic	4°23.00	N	18°37.00	E
Beirã, Mozambique	19°49.00	S	34°52.00	E
Cairo, Egypt	30°03.00	N	31°15.00	E
Capetown, South Africa	33°56.00	S	18°28.00	E
Dakar, Senegal	14°40.00	N	17°27.00	W
Fés, Morocco	34°05.00	N	5°00.00	W
Freetown, Sierra Leone	8°30.00	N	13°17.00	W
Harare, Zimbabwe	17°50.00	S	31°03.00	E
Kabwe, Zambia	14°29.00	S	28°25.00	E
Kampala, Uganda	0°19.00	N	32°35.00	E
Kano, Nigeria	12°00.00	N	8°31.00	E
Khartoum, Sudan	15°33.00	N	32°32.00	E
Kinshasa, Zaire	4°18.00	S	15°18.00	E
Kisangani, Zaire	0°33.00	N	25°14.00	E
Lagos, Nigeria	6°27.00	N	3°28.00	E
Las Palmas, Canary Islands	28°08.00	N	15°27.00	W
Lindi, Tanzania	10°00.00	S	39°41.00	E
Lobito, Angola	12°20.00	S	13°34.00	E
Lomé, Togo	6°10.00	N	1°21.00	E
Lubumbashi, Zaire	11°41.00	S	27°29.00	E
Lüderitz, Namibia	26°38.00	S	15°10.00	E
Lusambo, Zaire	4°59.00	S	23°26.00	E
Maputo, Mozambique	25°58.00	S	32°35.00	E
Maseru, Lesotho	29°19.00	S	27°29.00	E
Mbale, Uganda	1°04.00	N	34°12.00	E
Mogadishu, Somalia	2°02.00	N	45°21.00	E
Monrovia, Liberia	6°20.00	N	10°46.00	W
Mwanza, Zaire	7°51.00	S	26°43.00	E
N' Djamena, Chad	12°10.00	N	14°59.00	E
Nairobi, Kenya	1°17.00	S	36°50.00	E
Namibe, Angola	15°10.00	S	12°09.00	E
Nouakchott, Mauritania	18°09.00	N	15°58.00	W
Ouagadougou, Burkina Faso	12°20.00	N	1°40.00	W
Poinfe Noire, Congo	4°46.00	S	11°53.00	E
Port Elizabeth, South Africa	33°58.00	S	25°36.00	E
Sabha, Libya	27°02.00	N	14°26.00	E
Serowe, Botswana	22°25.00	S	26°44.00	E
Sidi Ifni, Morocco	29°24.00	N	10°12.00	W
Toliara, Madagascar	23°20.00	S	43°41.00	E
Tombouctou, Mali	16°49.00	N	2°59.00	W
Tripoli, Libya	32°54.00	N	13°11.00	E
Tsumeb, Namibia	19°13.00	S	17°42.00	E
Tunis, Tunisia	36°50.00	N	10°13.00	E
Windhoek, Namibia	22°34.00	S	17°06.00	E
Yaounde, Cameroon	3°51.00	N	11°31.00	E
Zanzibar, Zanzibar	6°10.00	S	39°12.00	E
Europe				
Athens, Greece	38°00.00	N	23°44.00	E
Barcelona, Spain	41°23.00	N	2°11.00	E
Bern, Switzerland	46°57.00	N	7°26.00	E
Bordeaux, France	44°50.00	N	0°34.00	W
Brno, Czechoslovakia	49°13.00	N	16°40.00	E
Bucuresti, Romania	44°25.00	N	26°07.00	E
Budapest, Hungary	47°30.00	N	19°03.00	E
Cork, Ireland	51°54.00	N	8°28.00	W
Gdansk, Poland	54°22.00	N	18°41.00	E
Glasgow, Scotland	55°53.00	N	4°15.00	W
Godthåb, Greenland	64°15.00	N	51°35.00	W
Hamburg, Germany	53°33.00	N	10°00.00	E
Istanbul, Turkey	41°02.00	N	28°57.00	E
London, England	51°30.00	N	0°10.00	W
Longyearbyen, Svalbard, Norway	78°12.00	N	15°40.00	E
Madrid, Spain	40°25.00	N	3°43.00	W
Napoli, Italy	40°50.00	N	14°16.00	E
Nice, France	43°42.00	N	7°16.00	E
Nuugaatsiaq, Greenland	71°30.00	N	53°00.00	W

Oslo, Norway	59°56.00	N	10°45.00	E
Paris, France	48°52.00	N	2°20.00	E
Reykjavik, Iceland	64°09.00	N	21°58.00	W
Scoresbysund, Greenland	70°30.00	N	22°00.00	W
Stensele, Sweden	65°05.00	N	17°10.00	E
Stockholm, Sweden	59°20.00	N	18°05.00	E
Thule, Greenland	76°35.00	N	68°30.00	W
Torshavn, Faeroes	62°02.00	N	6°47.00	W
Trabzon, Turkey	41°00.00	N	39°43.00	E
Vardo, Finland	60°16.00	N	20°20.00	E

The Americas



Albany, NY, U.S.A.	42°40.00	N	73°49.00	W
Albuquerque, NM, U.S.A.	35°05.00	N	106°38.00	W
Amarillo, TX, U.S.A.	35°14.00	N	101°50.00	W
Anchorage, AL, U.S.A.	61°10.00	N	150°00.00	W
Antofagasta, Chile	23°40.00	S	70°23.00	W
Arequipa, Peru	16°25.00	S	71°32.00	W
Atlanta, GA, U.S.A.	33°45.00	N	84°23.00	W
Barrows, AL, U.S.A.	71°16.00	N	156°50.00	W
Baton Rouge, LA, U.S.A.	30°30.00	N	91°10.00	W
Belem, Brazil	1°27.00	S	48°29.00	W
Bethel, AL, U.S.A.	60°49.00	N	161°49.00	W
Billings, MT, U.S.A.	45°47.00	N	108°30.00	W
Birmingham, AL, U.S.A.	33°30.00	N	86°55.00	W
Bismarck, ND, U.S.A.	46°50.00	N	100°48.00	W
Bogotá, Colombia	4°38.00	N	74°05.00	W
Boise, ID, U.S.A.	43°38.00	N	116°12.00	W
Boston, MA, U.S.A.	42°20.00	N	71°05.00	W
Brasilia, Brazil	15°45.00	S	47°57.00	W
Buffalo, NY, U.S.A.	42°52.00	N	78°55.00	W
Caracas, Venezuela	10°35.00	N	66°56.00	W
Casper, WY, U.S.A.	42°50.00	N	106°18.00	W
Cayenne, French Guiana	4°55.00	N	52°20.00	W
Charlotte, NC, U.S.A.	35°03.00	N	80°50.00	W
Chicago, IL, U.S.A.	41°50.00	N	87°45.00	W
Chihuahua, Mexico	28°40.00	N	106°06.00	W
Churchill, Manitoba, Canada	58°45.00	N	93°00.00	W
Cleveland, OH, U.S.A.	41°30.00	N	81°41.00	W
Comodoro R, Argentina	45°50.00	S	67°30.00	W
Coppermine, NW Terr., Canada	67°49.00	N	115°12.00	W
Córdoba, Veracruz Mexico	18°55.00	N	96°55.00	W
Cuiabá, Brazil	7°15.00	S	58°25.00	W
Dallas, TX, U.S.A.	32°47.00	N	96°48.00	W
Denver, CO, U.S.A.	39°45.00	N	105°00.00	W
Des Moines, Iowa, U.S.A.	41°35.00	N	93°35.00	W
Detroit, MI, U.S.A.	42°23.00	N	83°05.00	W
Duluth, MN, U.S.A.	46°45.00	N	92°10.00	W
Fairbanks, AL, U.S.A.	64°50.00	N	147°50.00	W
Fort McPherson, NW Terr., Canada	67°29.00	N	134°50.00	W
Fort Providence, NW Terr., Canada	61°03.00	N	117°40.00	W
Georgetown, Guyana	6°46.00	N	58°10.00	W
Grand Rapids, MI, U.S.A.	42°57.00	N	86°40.00	W
Guadalajara, Mexico	20°40.00	N	103°20.00	W
Guantánamo, Mexico	20°09.00	N	75°14.00	W
Guatemala, Guatemala	14°38.00	N	90°22.00	W
Guayaquil, Ecuador	2°13.00	S	79°54.00	W
Hazelton, BC Canada	55°15.00	N	127°38.00	W
Houston, TX, U.S.A.	29°45.00	N	95°25.00	W
Ilhéus, Brazil	14°50.00	S	39°06.00	W
Indianapolis, IN, U.S.A.	39°45.00	N	86°10.00	W
Iquitos, Peru	3°51.00	S	73°13.00	W
Juneau, AL, U.S.A.	58°20.00	N	134°20.00	W
Kansas City, MO, U.S.A.	39°02.00	N	94°33.00	W
La Habana, Cuba	23°08.00	N	82°22.00	W
Labrador City, NFLD, Canada	52°56.00	N	66°52.00	W

Las Vegas, NV, U.S.A.	36°10.00	N	115°10.00	W
Lima, Peru	12°06.00	S	77°03.00	W
Little Rock, AR, U.S.A.	34°42.00	N	92°17.00	W
Los Angeles, CA, U.S.A.	34°00.00	N	118°15.00	W
Louisville, KY, U.S.A.	38°13.00	N	85°48.00	W
Managua, Nicaragua	12°06.00	N	86°18.00	W
Manaus, Brazil	3°06.00	S	60°00.00	W
Merida, Venezuela	8°24.00	N	71°08.00	W
Miami, FL, U.S.A.	25°45.00	N	80°15.00	W
Milwaukee, WI, U.S.A.	43°03.00	N	87°56.00	W
Minneapolis, MN, U.S.A.	45°00.00	N	93°15.00	W
Montevideo, Uruguay	34°55.00	S	56°10.00	W
Nakina, BC, Canada	59°12.00	N	132°48.00	W
Nashville, TN, U.S.A.	36°10.00	N	86°50.00	W
New York, NY, U.S.A.	40°43.00	N	74°01.00	W
Norfolk, VA, U.S.A.	36°54.00	N	76°18.00	W
Oklahoma City, OK, U.S.A.	35°28.00	N	97°33.00	W
Omaha, NE, U.S.A.	41°15.00	N	96°00.00	W
Panama City, Florida	30°10.00	N	85°41.00	W
Panama City, Panama	8°57.00	N	79°30.00	W
Peace River, Alberta Canada	56°15.00	N	117°18.00	W
Peoria, IL, U.S.A.	40°43.00	N	89°38.00	W
Phoenix, AZ, U.S.A.	33°30.00	N	112°03.00	W
Pittsburgh, PA, U.S.A.	40°26.00	N	80°00.00	W
Port-au-Prince, Haiti	18°33.00	N	72°20.00	W
Portland, OR, U.S.A.	45°32.00	N	122°40.00	W
Porto Velho, Brazil	8°45.00	S	63°54.00	W
Québec, Québec, Canada	46°50.00	N	71°15.00	W
Rapid City, SD, U.S.A.	44°06.00	N	103°14.00	W
Recife, Brazil	8°06.00	S	34°53.00	W
Reno, NV, U.S.A.	39°32.00	N	119°49.00	W
Rio de Janeiro, Brazil	22°53.00	S	43°17.00	W
Salt Lake City, UT, U.S.A.	40°45.00	N	111°55.00	W
San Antonio, TX, U.S.A.	29°25.00	N	98°30.00	W
San Francisco, CA, U.S.A.	37°45.00	N	122°27.00	W
San Juan, Puerto Rico	18°29.00	N	66°08.00	W
Santarém, Brazil	2°26.00	S	54°41.00	W
São Paulo, Brazil	23°33.00	S	46°39.00	W
Saskatoon, Saskatchewan, Canada	52°10.00	N	106°40.00	W
Seattle, WA, U.S.A.	47°35.00	N	122°20.00	W
Shreveport, LA, U.S.A.	32°30.00	N	93°46.00	W
Sioux Falls, SD, U.S.A.	43°34.00	N	96°42.00	W
Spokane, WA, U.S.A.	47°40.00	N	117°25.00	W
St Louis, MO, U.S.A.	38°40.00	N	90°15.00	W
Tampa, FL, U.S.A.	27°58.00	N	82°38.00	W
Tijuana, Mexico	32°29.00	N	117°10.00	W
Toronto, Ontario, Canada	43°42.00	N	79°25.00	W
Valparaiso, Brazil	21°16.00	S	50°54.00	W
Vancouver, BC, Canada	49°13.00	N	123°06.00	W
Veracruz, Mexico	19°11.00	N	96°10.00	W
Washington, D.C., U.S.A.	38°55.00	N	77°02.00	W
Whitehorse, Yukon Terr., Canada	60°41.00	N	135°08.00	W
Wichita, KS, U.S.A.	37°43.00	N	97°20.00	W
Winnipeg, Manitoba, Canada	49°53.00	N	97°10.00	W
Pacific Ocean				
American Samoa	14°20.00	S	170°00.00	W
Baker I.	0°12.00	N	176°28.00	W
Easter I.	27°05.00	S	109°20.00	W
Gambier I.	23°10.00	S	135°00.00	W
Honolulu, HA, U.S.A.	21°19.00	N	157°50.00	W
Howland I.	0°48.00	N	176°38.00	W
Jarvis I.	0°23.00	S	160°02.00	W
Kanton I.	2°50.00	S	171°40.00	W
Lihue	21°59.00	N	159°23.00	W
Palmyra I.	5°52.00	N	162°05.00	W
Pitcairn I.	25°04.00	S	130°06.00	W
Swains I.	59°30.00	S	100°00	W



Glossary

Active Leg	The segment of a route currently being travelled.
Backtrack	Retraces the position fixes (up to 21) stored automatically by the GPS 4000 XL every 10 minutes.
Bearing	The compass direction from your position to a destination, measured to the nearest degree.
Coordinates	A unique numeric or alphanumeric description of position.
Course	The direction in degrees from the start landmark of a course line to its destination.
CTS	Course to steer. The optimum direction the vessel should be steered in order to efficiently make headway back to the courseline while also proceeding toward the destination landmark. It is a "compromise" course bearing that projects from your current position to a point on the courseline mid-way between a point perpendicular to your position and the current leg destination landmark.
Datum	Refers to the theoretical mathematical model of the earth's sea level surface. Map makers may use a different model from which to chart their maps, so position coordinates will differ from one datum to another. The datum for the map you are using can be found in the legend of the map.
Elevation	Distance above or below mean sea level.
EPE	Estimated Position Error is the approximate error (between 0 and X) introduced in the ephemeris signal by the U.S. Department of Defense for reasons of security. This random error, known as Selective Availability (SA) is not due to receiver error and is not significant enough to affect navigation for most purposes
Geometric Quality	Measures the probable accuracy of a position fix, based on the position of the satellites relative to each other.
GO TO	A single leg route with the present position being the start of the route and a defined landmark as the destination. (If the unit has been moved while turned off and has not yet acquired a new position fix, the start of the GO TO will be the position fix last recorded.)
Heading	The direction in which the GPS 4000 XL is moving, track or ground course. May be different from the course.





Landmark	A location saved in the unit's memory which is obtained by entering data, editing data, calculating data or saving a current position. Used to create routes.
Last Fix	Position coordinates computed and stored automatically every 10 minutes in the Last Fix Buffer.
Last Fix Buffer	The list of the most recent last fixes automatically stored by the GPS 4000 XL. (Up to 21 may be stored at one time.)
Latitude	The angular distance north or south of the equator measured by lines encircling the earth parallel to the equator in degrees from 0° to 90°.
LAT/LON	Coordinate system using latitude and longitude coordinates to define a position on the earth.
Leg (Route)	A segment of a route that has a starting (FROM) landmark and a destination (TO) landmark. A route may consist of 1 or more legs. A route that is from landmark A to landmark B to landmark C to landmark D has three legs with the first being from landmark A to landmark B.
Longitude	The angular distance east or west of the prime meridian (Greenwich meridian) as measured by lines perpendicular to the parallels and converging at the poles from 0° to 180°.
Magnetic North	The direction toward the north magnetic pole from the observer's position.
OSGB	A coordinate system describing only Great Britain, similar to UTM's. Used with GBR36 datum.
Position Fix	Position coordinates as computed by the GPS 4000 XL.
Reverse Route	Reverses the order of landmarks in an existing route.
Time To Go	The estimated time for the receiver to reach the destination from its current position based on the current VMG.
True North	The direction to the geographical North Pole from an observer's position. The north direction on any geographical meridian.
Track	The actual path travelled, may differ from the planned course.
Track History	The track over a selected period of time.
UT	Universal Time, formerly referred to as Greenwich Mean Time (GMT).
UTM	Universal Transverse Mercator (UTM) metric grid system used on most large and intermediate scale land topographic charts and maps.
VMG	Velocity Made Good. The component of the velocity that is in



Index

- Abbreviations 87
 - Accuracy 3, 84
 - Antenna 68
 - Backtrack 39
 - Batteries, installation 4
 - Baud rate 56
 - CDI (Course Deviation Indicator) 18
 - Clear Menu 49; clearing all last fixes 50, clearing track 50, clearing all landmarks and routes 50, clearing all memory 51
 - City Reference Chart 88
 - Contrast 15, 58
 - COORD 39, using PAN N SCAN 24
 - Coordinate System 51,79
 - Customer service 66
 - Customizing, SETUP 51, NAV Screens 19
 - Datums 77
 - DGPS 84
 - Distance Units 54
 - Elevation mode 51; units 54
 - External power 67
 - First time use 4
 - Getting started 3
 - Glossary 94
 - GO TO 12; activating 39; creating with PAN N SCAN 23, creating a coordinate GO TO route 39
 - GPS 83
 - Icons 62
 - Initial Position Fix/First Time Use 4
 - Initializing 5, 51
 - Inputting data 14
 - Introduction 1
 - Landmarks 24, creating 24; creating with user-entered coordinates 28, landmark messages 31; deleting 36; editing 35; projecting 32; saving a Landmark with different coordinates 11; saving a Position as a Landmark 10,26; viewing 30, landmark sort 57, creating using PAN N SCAN 23; viewing landmark messages 23
- Magellan GPS 4000 XL Satellite Receiver* 95



Last Fix Buffer 37, deleting a (single) Last Fix 38; Viewing the Last Fix Buffer 37; copying a last fix as a landmark 37

LAT/LON 79

Leg (see Routes)

Light 14

Map Datum 55

Map Distance 59

Map projection 348, scale 58

Map scale 58

Messages, attaching to landmarks 27; deleting 31; editing 31; viewing 31, viewing from PAN N SCAN 23,

Navigation screens 16, NAV 1 screen 17

NMEA 56, 72

North Reference 55

Odometer 49

ON/OFF 13

Packing list 1

PAN N SCAN 22, creating a landmark from 23, viewing a landmark message from 23, creating GO Tos from 23; creating GO TO COORDs from 24

Plotter 21, clearing track 22, track orientation 56

Pointer screen 20

Position screen 17, initial position fix 4, second position screen 57

Positions, saving as a landmark 26, saving a position with a receiver-generated name 26, saving a position with a user-created name 27

Power 13, 67

Projecting a Landmark 32

Road screen 24

Routes 11, 39; activating 42; adding a leg to the end of a route 44; deleting 47; creating 40; deactivating 42; reversing 43; Route Menu 40, editing 43, inserting a leg in a route 44, replacing a landmark 45, deleting a leg 45, viewing a leg 46, activating a leg 47

Sat Status 59



Screens, see Navigation screens

SETUP menu 51

Signal reception 9



Simulator 60

Sort, changing landmark sort order 57





Specifications 78
Speed Units 54
Sun/Moon 48
Swivel Mount Bracket 70
Time Display 53
Track, setting plotter track 58, deleting track 22
Triangulation 33
Troubleshooting 65
Upload/Download landmark data 69
User Grids 81
UTM 59, 79
Warning messages 63
What is GPS? 83



Free Manuals Download Website

<http://myh66.com>

<http://usermanuals.us>

<http://www.somanuals.com>

<http://www.4manuals.cc>

<http://www.manual-lib.com>

<http://www.404manual.com>

<http://www.luxmanual.com>

<http://aubethermostatmanual.com>

Golf course search by state

<http://golfingnear.com>

Email search by domain

<http://emailbydomain.com>

Auto manuals search

<http://auto.somanuals.com>

TV manuals search

<http://tv.somanuals.com>