



For complete details on using your Magellan®  
RoadMate® RV9365T-LMB, please go to  
**magellanGPS.com/support**  
and download the user manual in .pdf format.



**Magellan RoadMate  
RV9365T-LMB**

**User Manual**

# Safety

## IMPORTANT SAFETY WARNINGS

The Magellan RoadMate receiver is a vehicle-navigation aid designed to assist you in arriving at your selected destinations. When using the Magellan RoadMate receiver, these safety rules must be followed to prevent accidents that can result in injury or death to yourself or others:

Please check the applicable regulations in your state regarding windshield mounting. Certain states prohibit the mounting of any items on your windshield. Go to [www.magellanGPS.com](http://www.magellanGPS.com) for alternative mounting solutions.

When driving, the need to view the display is minimal. Voice prompts will guide you to your destination. The driver should enter data or program the Magellan RoadMate receiver only when the vehicle is stationary. Only a vehicle passenger should enter data or program the Magellan RoadMate receiver while the vehicle is moving. Do not become distracted by the receiver while driving, and always be fully aware of all driving conditions.

It is your responsibility to comply with all traffic laws and to use the Magellan RoadMate and mounting options in such a manner that the user is in compliance with applicable laws.

Roads, points of interest (POIs), business and service locations may change over time. As a result the database may contain inaccuracy. Also, the database does not include, analyse, process, consider, or reflect any of the following: legal restrictions (such as vehicle type, weight, height, width, load and speed restrictions); road slope or gradient; bridge height, width, weight or other limits; population density; neighborhood quality or safety; availability or proximity of police, emergency rescue, medical or other assistance; construction work zones or hazards; road or lane closures; road, traffic or traffic facilities' safety or condition; weather conditions; pavement characteristics or conditions; special events; traffic congestion. It is your responsibility to disregard any unsafe, hazardous or illegal route suggestions.

Keep the Magellan RoadMate receiver safe from extreme temperature conditions. For example, do not leave it exposed to direct sunlight for an extended period of time.

Take care when mounting the Magellan RoadMate receiver in your vehicle, whether using the windshield mount or other mounts, that it does not obstruct the driver's view of the road, interfere with the operation of the vehicle's safety devices such as air bags, or present a hazard to occupants of the vehicle should the receiver be dislodged while driving. It is your responsibility to assess the risks associated with damage to your vehicle or vehicle occupants as the result of your choices in mounting the Magellan RoadMate receiver.

### Temperature

The maximum operating temperature is 140°F (60°C).

### Battery

The battery in the Magellan RoadMate receiver is rechargeable and should not be removed. In the event that it should need to be replaced, please contact Magellan Technical Support.

## **Charging the Magellan RoadMate**

An optional AC adapter is available as an accessory for your Magellan RoadMate. Use of another type of AC adapter can result in malfunction and/or possible fire hazard due to battery overheating.

Only use the car charger approved for/supplied with your Magellan RoadMate receiver. Use of another type of car charger will result in fire or electric shock.

For safety reasons, the battery in your Magellan RoadMate receiver will stop charging when the ambient temperature is less than 32°F (0°C) or more than 113°F (45°C).

It will take approximately 4 hours of charging the Magellan RoadMate receiver through the vehicle power adapter or optional AC adapter to obtain a full battery charge. It is recommended that you charge the battery initially for at least 2 hours.

Use only the charger approved for your Magellan RoadMate receiver.

Estimated usage of the Magellan RoadMate on battery power is approximately 2 hours.

## **Federal Communication Commission Interference Statement**

This equipment has been tested and found to comply with the limits for class B digital devices, in accordance with part 15 of the FCC Rules. These limits are designed to provide reasonable protection against harmful interference in a residential installation. This equipment generates, uses and can radiate radio frequency energy and, if not installed and used in accordance with the instructions, may cause harmful interference to radio communications. However, there is no guarantee that interference will not occur in a particular installation. If this equipment does cause harmful interference to radio or television reception, which can be determined by turning the equipment off and on, the user is encouraged to try to correct the interference by one of the following measures:

Reorient or relocate the receiving antenna.

Increase the separation between the equipment and receiver.

Connect the equipment into an outlet on a circuit different from that to which the receiver is connected.

Consult the dealer or an experienced radio/TV technician for help.

This device complies with Part 15 of the FCC Rules. Operation is subject to the following two conditions: (1) This device may not cause harmful interference, and (2) this device must accept any interference received, including interference that may cause undesired operation.

FCC Caution: Any changes or modifications not expressly approved by the party responsible for compliance could void the user's authority to operate this equipment.

## **IMPORTANT NOTE:**

### **FCC Radiation Exposure Statement:**

This equipment complies with FCC radiation exposure limits set forth for an uncontrolled environment. End users must follow the specific operating instructions for satisfying RF exposure compliance.

This transmitter must not be co-located or operating in conjunction with any other antenna or transmitter.

In order to maintain compliance with FCC regulations, shielded cables must be used with this equipment. Operation with non-approved equipment or unshielded cables is likely to result in interference to radio and TV reception. The user is cautioned that changes and modifications made to

the equipment without the approval of manufacturer could void the user's authority to operate this equipment.

The Magellan RoadMate receiver must be installed and operated at a distance no closer than 8 inches (20 cm) from the user.

This Class B digital apparatus meets all requirements of the Canadian Interference-Causing Equipment Regulations.

### **IC statement**

Operation is subject to the following two conditions:

1. This device may not cause interference and
2. This device must accept any interference, including interference that may cause undesired operation of the device.

### **IMPORTANT NOTE:**

#### **IC Radiation Exposure Statement:**

This equipment complies with IC radiation exposure limits established for an uncontrolled environment. End users must follow the specific operating instructions for satisfying RF exposure compliance.

This transmitter must not be co-located or operated in conjunction with any other antenna or transmitter.

The information provided in this document is subject to change without notice. Improvements and enhancements to the product may occur without any formal notification. Check the Magellan website ([www.magellanGPS.com/support](http://www.magellanGPS.com/support)) for product updates and additional information.

© 2013 MiTAC International Corporation. The Magellan logo, Magellan, RoadMate and Quickspell are registered trademarks of MiTAC International Corporation. SmartDetour and OneTouch are trademarks of MiTAC International Corporation and are used under license by MiTAC International Corporation. All rights reserved.

All other products and brand names are trademarks of their respective holders.

No part of this user manual may be reproduced or transmitted in any form or by any means, electronic or mechanical, including photocopying and recording, for any purpose other than the purchaser's personal use, without the prior written permission of MiTAC International Corporation.

The information provided in this document are correct at the time that it is created. MiTAC International Corporation assumes no responsibility or liability for any errors or inaccuracies that may appear in the contents of this User Manual.

112-0063-001 A

# Table of Contents

<b>Introduction</b> .....	<b>1</b>
<i>Powering on the Magellan RoadMate receiver</i> .....	3
<i>Turning the Magellan RoadMate receiver On</i> .....	3
<i>Turning the Magellan RoadMate receiver Off</i> .....	3
<i>Checking Battery Level and GPS Status</i> .....	3
<i>Viewing the Battery Level Indicator</i> .....	3
<i>Checking GPS Status</i> .....	3
<b>Fundamentals</b> .....	<b>3</b>
<i>Volume</i> .....	4
<i>Changing the Volume from the Map Screen</i> .....	4
<i>Changing the Volume from Settings</i> .....	4
<i>Setting Button Sounds on or off</i> .....	4
<i>Brightness</i> .....	4
<i>Accessing the Brightness Control</i> .....	4
<i>Main Menu</i> .....	5
<i>Accessing the Main Menu</i> .....	5
<i>Buttons on the Main Menu Screen</i> .....	5
<i>Keypad</i> .....	6
<i>Selecting From List</i> .....	6
<i>Selecting QWERTY or ABC Keyboard</i> .....	6
<i>Notes on Entering Data</i> .....	7
<i>Smart City Search</i> .....	7
<i>QuickSpell</i> .....	7
<i>Selecting the Location</i> .....	8
<i>Securing the Car Cradle</i> .....	8
<i>Attaching the Magellan RoadMate receiver to the Car Cradle</i> .....	8

<b>Installation .....</b>	<b>8</b>
<i>Adjusting the Mount for Optimum Viewing .....</i>	9
<i>Connecting Power .....</i>	9
<i>Power Switch .....</i>	9
<i>Security.....</i>	9
 <b>Map Screen.....</b>	 <b>10</b>
<i>Accessing the Map Screen.....</i>	11
<i>Setting the Map Modes (2D or 3D).....</i>	11
<i>Setting Zoom Levels.....</i>	12
<i>Panning on the Map.....</i>	12
<i>Routing to a Panned Position.....</i>	12
<i>Current Location Screen.....</i>	13
<i>Accessing the Current Location Screen.....</i>	13
<i>Saving Your Current Location to Your Address Book.....</i>	13
<i>Maneuver List (Itinerary).....</i>	13
<i>Accessing the Maneuver List.....</i>	13
<i>Excluding a Maneuver .....</i>	14
<i>Volume.....</i>	14
<i>Changing the Volume from the Map Screen .....</i>	14
<i>Creating a Destination to an Address.....</i>	15
 <b>Creating a Destination .....</b>	 <b>15</b>
<i>Tips on Entering Addresses Quickly.....</i>	16
<i>Creating a Destination to an Intersection.....</i>	16
<i>Creating a Destination to a City Center.....</i>	17
<i>Previous Destinations .....</i>	17
<i>Routing to a Previous Destination.....</i>	17
<i>Saving a Previous Destination to Your Address Book.....</i>	17
<i>Clearing the list of Previous Destinations.....</i>	18
<i>Address Book .....</i>	18
<i>Accessing an Address in Your Address Book .....</i>	18

<i>Routing to an Address in Your Address Book .....</i>	<i>18</i>
<i>Creating a New Entry in Your Address Book by Entering an Address.....</i>	<i>19</i>
<i>Creating a New Entry in Your Address Book from a POI.....</i>	<i>19</i>
<i>Saving an Address to a OneTouch Icon.....</i>	<i>21</i>
<i>Changing the Address or Search of a OneTouch Icon .....</i>	<i>21</i>
<i>Saving a POI Search Criteria to a OneTouch Icon.....</i>	<i>21</i>
<b>OneTouch Menu .....</b>	<b>21</b>
<i>Setting a Route to a OneTouch Icon.....</i>	<i>22</i>
<i>Creating a Route to a POI by Category .....</i>	<i>24</i>
<i>Creating a Route to a POI by Name .....</i>	<i>24</i>
<b>Points of Interest (POI) .....</b>	<b>24</b>
<i>Creating a Route to a Highway Exit POI .....</i>	<i>25</i>
<i>Saving the Home Address.....</i>	<i>26</i>
<i>Changing the Home Address.....</i>	<i>26</i>
<i>Creating a Route to the Home Address .....</i>	<i>26</i>
<b>Home Address .....</b>	<b>26</b>
<i>Map Screen .....</i>	<i>28</i>
<i>Maneuver List.....</i>	<i>28</i>
<i>Types of Routes.....</i>	<i>28</i>
<i>Routing Method.....</i>	<i>28</i>
<i>To permanently change the routing method .....</i>	<i>28</i>
<b>Traveling on a Route .....</b>	<b>28</b>
<i>Special Routing Functions.....</i>	<i>29</i>
<i>Cancelling a Route .....</i>	<i>29</i>
<i>Detouring off a Route .....</i>	<i>29</i>
<i>SmartDetour™ on Freeways .....</i>	<i>29</i>
<i>Creating Additional Destinations with Go To .....</i>	<i>30</i>

<b>Multi Destination Routes .....</b>	<b>30</b>
<i>Editing the Destination List .....</i>	<i>31</i>
<i>Pairing your Bluetooth-ready Phone for the First Time .....</i>	<i>32</i>
<b>Bluetooth.....</b>	<b>32</b>
<i>Bluetooth Settings .....</i>	<i>33</i>
<i>Accessing the Bluetooth Settings.....</i>	<i>33</i>
<i>Enabling/Disabling Bluetooth.....</i>	<i>33</i>
<i>Enabling/Disabling Auto Connect.....</i>	<i>33</i>
<i>Enabling/Disabling Audible Maneuver Warning.....</i>	<i>33</i>
<i>Pairing Additional Bluetooth-ready Phone .....</i>	<i>33</i>
<i>Importing Contacts .....</i>	<i>33</i>
<i>Calling Home.....</i>	<i>33</i>
<i>Redial .....</i>	<i>34</i>
<i>Manual Dialing .....</i>	<i>34</i>
<i>Dialing a Phone Number from the Address Book .....</i>	<i>34</i>
<i>Speed Dialing.....</i>	<i>34</i>
<i>Assigning a Phone Number to Speed Dialing.....</i>	<i>34</i>
<i>Speed Dialing a Phone Number .....</i>	<i>35</i>
<i>Answering a Call.....</i>	<i>35</i>
<i>Available Options During a Call.....</i>	<i>35</i>
<i>Hanging Up.....</i>	<i>35</i>
<i>Entering Numeric Data.....</i>	<i>35</i>
<i>Setting Volume and Microphone Gain.....</i>	<i>35</i>
<i>Accessing Vehicle Profile.....</i>	<i>36</i>
<i>Set Vehicle Height.....</i>	<i>36</i>
<i>Set Vehicle Width.....</i>	<i>36</i>
<i>Set Vehicle Weight.....</i>	<i>36</i>
<i>Set Vehicle Total Length.....</i>	<i>36</i>



<b>Vehicle Profile .....</b>	<b>36</b>
<i>Set Vehicle Type .....</i>	<i>37</i>
<i>Set Hazmat Type .....</i>	<i>37</i>
<i>Accessing System Settings .....</i>	<i>38</i>
<i>Setting Languages.....</i>	<i>38</i>
<i>Setting Auto Power.....</i>	<i>38</i>
<i>Setting Brightness.....</i>	<i>38</i>
 <b>Settings .....</b>	 <b>38</b>
<i>Setting the Time Format.....</i>	<i>39</i>
<i>Selecting the Time Zone.....</i>	<i>39</i>
<i>Selecting Units of Measure .....</i>	<i>39</i>
<i>Map Options.....</i>	<i>39</i>
<i>Setting Auto Night Map Display.....</i>	<i>39</i>
<i>Setting Heading Up or North Up in 2D Mode .....</i>	<i>40</i>
<i>Assigning Visible POIs .....</i>	<i>40</i>
<i>Setting Auto Zoom on Turns .....</i>	<i>40</i>
<i>Setting Highway Lane Assist.....</i>	<i>40</i>
<i>Sound.....</i>	<i>40</i>
<i>Setting Volume from Settings.....</i>	<i>40</i>
<i>Muting the Sound.....</i>	<i>41</i>
<i>Turning off Button Sounds .....</i>	<i>41</i>
<i>Navigation Preferences.....</i>	<i>41</i>
<i>Setting The Default Route Method.....</i>	<i>41</i>
<i>Setting The Turn Warning Alert Sounds .....</i>	<i>41</i>
<i>Enabling U Turn Guidance.....</i>	<i>41</i>
<i>Avoiding Toll Roads .....</i>	<i>41</i>
<i>Keyboard.....</i>	<i>42</i>
<i>Setting the Keyboard Layout. ....</i>	<i>42</i>
<i>GPS Options.....</i>	<i>42</i>
<i>Setting the GPS Position .....</i>	<i>42</i>

*Viewing the GPS Status* ..... 42  
*Default System Settings*..... 42  
*Restoring All Default System Settings*..... 42  
*Viewing Product Information* ..... 43  
*Regions*..... 43

# Introduction

## Magellan RoadMate Receiver

The Magellan® RoadMate® receiver is a vehicle navigation product that utilizes GPS signals from satellites to calculate your precise location and compute navigational information that can be used to guide you to your destination. Knowing its position and movement, it can then overlay this information on detailed maps to provide a visual representation of your location.

With the Magellan RoadMate receiver you can:

- Save searches and addresses under the OneTouch™ menu for fast, convenient access to favorite destinations.
- Store your home address and quickly get routing details to your home.
- Enter and save addresses in your address book that can be accessed at any time and get routing information to that address.
- Route to an address that you enter using the QuickSpell™ and Smart City search for easy, errorless address entry.
- Route to any point of interest (POI) that has been preloaded into your Magellan RoadMate receiver.
- Create a route with multiple destinations. Handy for business people who need routing information to many destinations.
- Access Good Neighbor Sam RV Parks and Services information.
- View POIs that are near exits ahead of you on the highway. The Highway Exit POIs function provides you with a list of gas stations, restaurants, hotels and auto repair shops located nearby exits you are approaching while travelling on the interstate.
- Customize your Magellan RoadMate receiver to meet your needs using the Settings menu.

The user interface for the Magellan RoadMate receiver is easy and simple to follow once you understand the basics. You may never need to refer to this manual, but if you do, we have tried to present it in a form that makes it easy for you to access the function you are trying to use and follow the steps provided.

The Magellan RoadMate receiver has a built-in battery so, in most cases, you will be able to follow these instructions while reading them on your computer screen without plugging the Magellan RoadMate receiver to the AC power using an optional AC power adapter. You should note that while indoors you may not get strong enough satellite signals to compute your location, so your location information may not be updated. However, the power of the GPS chipset installed in the Magellan RoadMate receiver will pick up satellite signals in some very demanding locations. You may find that the Magellan RoadMate receiver is computing a position, even indoors. Even with the improved GPS chipset, the receiver may not be able to always compute a fix indoors. This is especially important to note if you are in a garage or other overhanging structure. If you find you are not getting strong enough satellite signals while in a garage or other structure, move to a location where there is a clear view of the sky and you should immediately see an improvement in signal strength.

The Magellan RoadMate receiver includes Voice Alerts (Text-to-Speech) for driving instructions. This document is set up to be printed on 8.5" x 11" paper should you desire a printed version for your reference.

## Magellan RoadMate



(A) Power Switch

(B) AV Input. (Audio and video input to connect to portable DVD players, cameras, or any device with an AV output. Requires 3.5mm AV cable.)

(C) Power Input

(D) Micro SD card slot (A micro SD card is optional and is used for possible updates.)

# Fundamentals

## ***Powering on the Magellan RoadMate receiver***

The Power On/Off switch is located on the top of the Magellan RoadMate receiver.

## ***Turning the Magellan RoadMate receiver On***

1. Slide the Power button to the left.
2. After the initial splash screen the Warnings screen is displayed. Read and tap .

## ***Turning the Magellan RoadMate receiver Off***

1. Slide the Power button to the center position.
2. Resetting the Magellan RoadMate receiver Off
3. Slide the Power button to the right.

## ***Checking Battery Level and GPS Status***

The Magellan RoadMate receiver has an internal battery that permits use of the receiver for brief periods of time while not connected to external power. The battery is charging whenever the Magellan RoadMate is connected to external power. Please note that this battery can only be serviced by authorized Magellan repair facilities.

## ***Viewing the Battery Level Indicator***

1. While viewing the Map screen, tap on the Menu button.
2. The battery level indicator is located in the upper right corner of the Menu screen, just below the satellite signal indicator. Green bars indicate battery level.

The Magellan RoadMate can normally function for 2 hours on battery when the battery life is full.

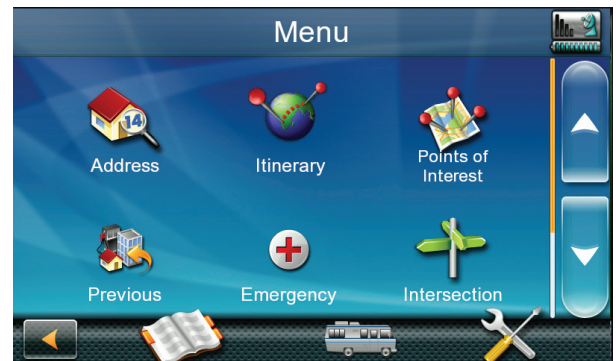

## ***Checking GPS Status***

1. While viewing the Map screen, tap on the Menu button.
2. The GPS status indicator is located in the upper right corner of the Menu screen. Four green bars would indicate optimum satellite signal reception.

## Volume

### Changing the Volume from the Map Screen

1. Tap the speaker icon . Additional controls appear.
2. Tap the Mute button to mute the volume, or tap the '+' or '-' buttons to raise or lower the volume.
3. Tap .

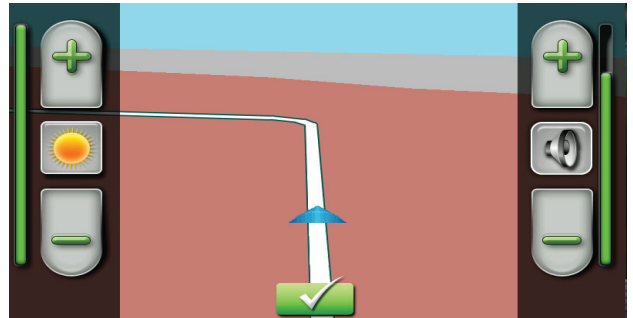

### Changing the Volume from Settings

1. Access the Main Menu.
2. Tap the Settings icon .
3. Tap Sound.
4. Tap inside the Master volume adjust bar to change the volume level of the Magellan RoadMate receiver.
5. Tap  to save and exit.

### Setting Button Sounds on or off

1. Access the Main Menu.
2. Tap the Settings icon .
3. Tap Sound.
4. Tap the check box for Button Sounds. Check to have button sounds played, unchecked to turn them off.
5. Tap  to save and exit.

## Brightness

### Accessing the Brightness Control

1. Access the Main Menu.
2. Tap the Settings icon .
3. Tap Brightness.
4. Tap inside the brightness adjust bar to set the desired brightness.
5. Tap  to save and exit.

On the Brightness screen there is a Dim on Battery Power option. When Dim on Battery Power is checked, the Magellan RoadMate receiver will reduce the brightness when operating exclusively on battery power and you have not used the touch screen for a few seconds. This prolongs the battery life between charges.

## Main Menu

The Main Menu contains large, easy to access icons for all the major functions.











### Accessing the Main Menu

When you first turn on the Magellan RoadMate receiver, the Main Menu is displayed after the splash and warning screens. While in use, you can access the Main Menu by:

1. From the Map screen tap Menu.



### Buttons on the Main Menu Screen





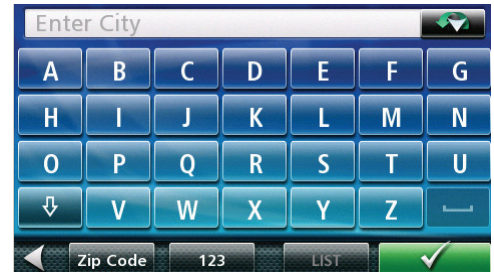

Button	Name	Description
	Address	Used to enter an address as a destination for your route.
	Itinerary	Create a single stop trip, a multiple stop trip or daily trips.
	Points of Interest	Select a Point of Interest (POI) from the list of preloaded locations you may want to go to.
	Previous	List of the most recent destinations that you have gone to before allowing you to quickly select one to route to again.
	Address Book	Access the Address Book where you can save addresses and destinations to have available when needed.
	Intersection	Used to create a route to the intersection of two streets.
	Emergency	Access Emergency Services categories.
	Settings	Displays the Settings menu. This menu can be used to access functions used to customize the Magellan RoadMate receiver to your personal needs.
	Current Location	Displays information about your position including the street name, names of streets forward and behind you as well as the Lat/Long information for your position.
	Vehicle Profile	Set information about your vehicle so the route calculated takes into consideration information about your vehicle's height, width, etc.

## Keypad

Understanding the keypad while entering an address is an important part of using your Magellan RoadMate receiver. The keypad is the most common method for entering data into the Magellan RoadMate receiver.

### Keypad Overview



Button	Name	Description
	Data Field	Top of the display where the characters entered are shown. Characters you enter are displayed in black, characters that are filled in by the Magellan RoadMate receiver are in green. If the receiver has been able to estimate the desired city or street, tap on the data field to accept the entry.
	Previous destination list	(Enter City only) When entering a city, the previous destinations list displays a list of cities previously entered. Tap on a city from the displayed list to accept that city.
	Zip Code	(Enter City only) Displays a numeric keypad to quickly enter a city when the zip code is known.
	Numeric Keypad	Displays a numeric keypad that can be used to enter streets or cities that have numbers in their name. (This is not to be used for entering an address number.)
	List	(Enter City only) While entering a city, press the List button to bring up a list of cities beginning with the characters you have entered.
	Accept	(Entering City) Accepts the suggested city that is displayed in the data field. (Entering street) Brings up a list of streets beginning with the characters entered.

### Selecting From List

When a list of items found in the database are displayed, use the arrows on the right to move the list up and down and tap on the desired item in the list to continue.

### Selecting QWERTY or ABC Keyboard

1. Access the Main Menu.
2. Tap the Settings icon .
3. Tap Keyboard.
4. Select QWERTY or ABC.



## Notes on Entering Data

If you are having trouble getting the results you expected, here are a few useful tips.

- Check for apostrophes and hyphens. If you do not see the POI or street name you are looking for in the list, check to see if the name has an apostrophe or hyphen.
- The more characters you enter, the smaller the list of possible options is from which to choose.
- When entering a street or city name it is not necessary to use accented letters. You can enter city and streets names using only standard characters.

## Smart City Search

The Magellan RoadMate receiver utilizes a feature known as “Smart City Search”. Smart City Search attempts to predict the city you are looking for. This prediction is based upon two factors; your position and cities you’ve gone to before.

In this example I am in Los Angeles and enter “PA”. The receiver looks for cities I’ve already gone to as well as cities near my location that begin with “PA” and, in this case comes up with “PASADENA, CA”.

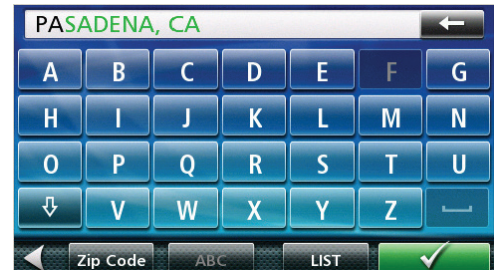

In this example “PA” has been entered again but this time the receiver is in Atlanta, GA. The city displayed now is Palmetto, GA, so location has changed the predicted city to one closer to your location.



## QuickSpell

Another feature the Magellan RoadMate receiver uses to make entering cities and streets easier is a feature known as QuickSpell. In the example to the right, “CE” has been entered for a street name in Chicago, IL. The Magellan RoadMate receiver has predicted that the street name may be Cedar Ave. Also, it has greyed out any letters that could not be used to spell a street name in the database. This provides quick and error-free city and street name entry.

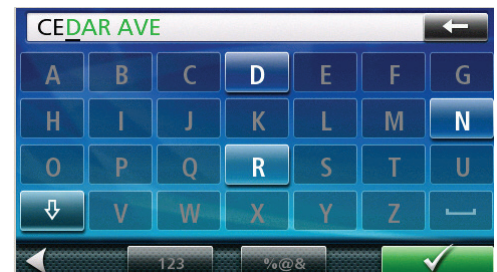

# Installation

Installation of the Magellan RoadMate receiver is simple and easy. The hardest part will be picking the best location.

## **Selecting the Location**

A few tips on selecting the proper location.

- Mount the Magellan RoadMate receiver in a place where it can be easily seen and will not interfere with your view of the road.
- The Magellan RoadMate receiver should be mounted in such a way that the antenna, (located in the top of the receiver), has an unobstructed view of the sky through the windshield.
- Make sure that the Magellan RoadMate receiver or any cabling will not be disturbed if the airbags are activated.
- Be sure to check your local and regional laws before mounting to the windshield. Some states have laws restricting the mounting of any device on the windshield.

## **Securing the Car Cradle**

Clean the area on the windshield that has been selected for mounting the Magellan RoadMate receiver. Let the area dry completely.

Make sure that the lever at the base of the adjustable mount is in the up position. Place the base of the car cradle firmly over the area where it will be placed. Push the lever at the base of the swivel mount all the way down until it snaps in place. Carefully let go of the assembly, making sure that it is securely mounted.

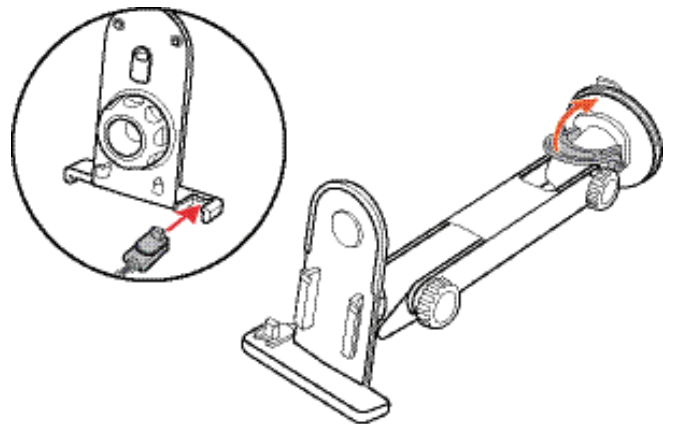

(The Car Cradle shown here may be different from the Car Cradle supplied with your Magellan RoadMate receiver, but the installation is the same for all cradle styles.)

## **Attaching the Magellan RoadMate receiver to the Car Cradle**

Slide the Magellan RoadMate receiver on the car cradle so that the slot on the Magellan RoadMate receiver aligns with the tab on the car cradle. Slide the Magellan RoadMate receiver all the way down until it rests on the 'feet'. You should notice a click when the receiver is fully mounted in the cradle.

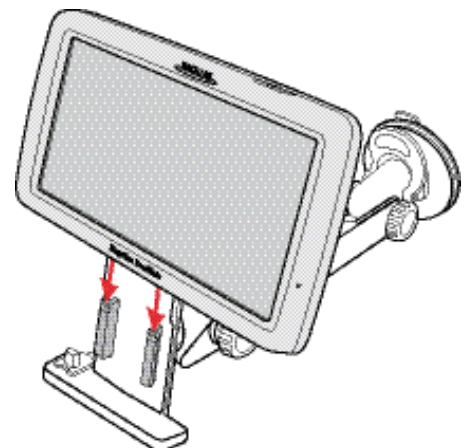

## ***Adjusting the Mount for Optimum Viewing***

Loosen the adjustment locking knob and position the Magellan RoadMate receiver for optimum viewing. Once set, tighten the locking knobs. (Never attempt to adjust the mount while driving.)

## ***Connecting Power***

Plug the end of the vehicle power adapter into a 12VDC vehicle power receptacle. Connect the other end of the cable to the Magellan RoadMate receiver's power connector as shown.

Note: Some vehicles apply power to the vehicle power receptacle only when the ignition is on.

### ***Checking Connection and Final Adjustments***

If the power indicator light on the vehicle power adaptor is on, power is being supplied to the Magellan RoadMate receiver. If it is not on, check the cable connection to the vehicle power receptacle. If the light is still not on, turn the vehicle's ignition on.

## ***Power Switch***

Slide the power switch to the left turn the receiver on. Slide the power switch to the center position to turn the receiver off. (Slide the power switch to the right to reset. [Power Reset] can sometimes solve any problems encountered while using the receiver.)

## ***Security***

It is recommended that the Magellan RoadMate receiver is not left in plain view while unattended for reasons of theft.

Please note that the Magellan RoadMate receiver is a receiver only and does not transmit GPS location signals. Neither the receiver nor the vehicle can be tracked using the Magellan RoadMate receiver.

# Map Screen

The most commonly used screen is the Map screen. Whether you are following a route or just traveling around a city, the chances are that the Map screen will be displayed. The Map screen can be displayed in two unique modes: normal and routing.

In normal mode, your position is shown on the map along with the time. As you travel, your position will be updated, giving you a clear view of your position and surrounding streets.

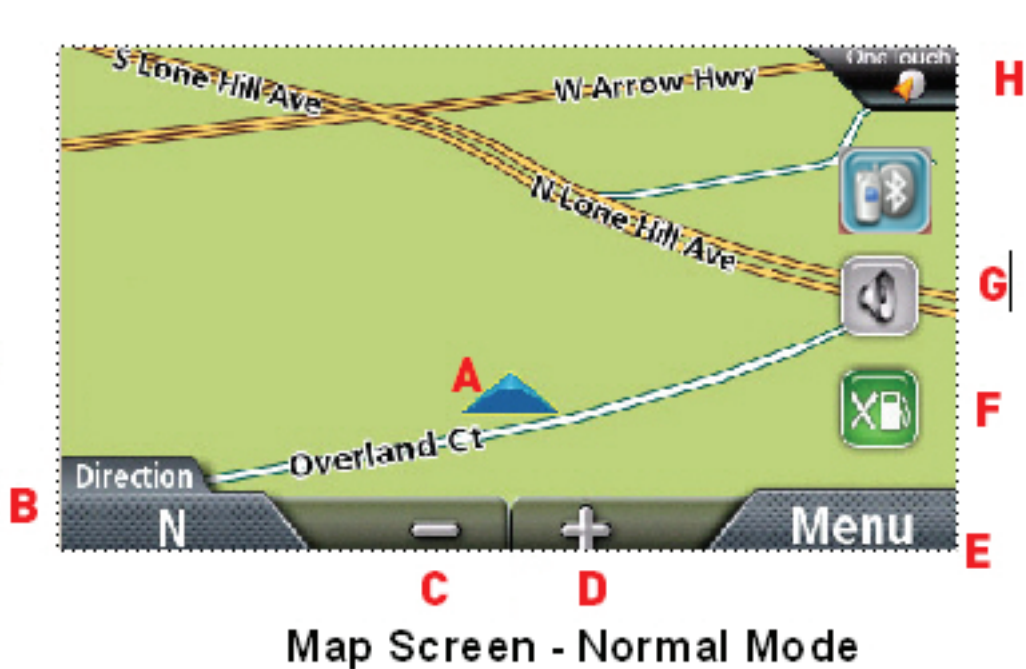

- (A) Current location.
- (B) Information display. Displays speed, time of day, elevation, compass direction. Tap on the information field to change.
- (C) Zoom Out
- (D) Zoom In
- (E) Access Main Menu.
- (F) Access Highway POIs (displayed only while on a highway).
- (G) Access volume controls.
- (H) Access OneTouch Menu. OneTouch Menu gives you instant access to your saved search criteria and favorite destinations.

In routing mode additional information is displayed providing detailed information about the route you have selected.



## Map Screen - Routing Mode

- (A) Turn instructions for next maneuver. Tap to display the maneuver list (available only when routing). Distance and road name for the next maneuver. Tap to repeat last voice instruction.
- (B) Speed limit
- (C) Information display. Displays speed, time of day, elevation, compass direction. While routing it also can also display distance to destination, estimated time of arrival (ETA), and time remaining. Tap on the information field to change.
- (D) Zoom Out
- (E) Current position and heading.
- (F) Zoom in controls to change the map scale.
- (G) Access Main Menu.
- (H) Access the list of nearest Highway Exit POIs (available only when driving on a highway/freeway/interstate).
- (I) Access volume controls.

### Accessing the Map Screen

1. On the Main Menu screen, tap the Back arrow.

### Setting the Map Modes (2D or 3D)

The map is normally displayed in 3D mode (perspective view) but you can set the map to 2D mode (top down view) if so desired. Choose the mode that suits you best.

1. From the Map screen, tap anywhere on the map. Additional controls appear.
2. Tap 2D to switch the map to 2D mode from 3D mode, or tap 3D to switch the map to 3D mode from 2D mode.

3. Tap .

### **Setting Zoom Levels**

Select the zoom level that best suits your needs. Note that zoom levels are limited in 3D mode. As you zoom out in 3D, the display will switch to 2D at higher zoom levels.

1. Tap the '+' or '-' zoom level buttons at the bottom of the display to set the desired zoom level.

### **Panning on the Map**

1. While viewing the Map screen, slide your finger or a stylus across the map.
2. The map screen changes to Pan mode.
3. When finished, tap  and the map returns to your current position.

### **Routing to a Panned Position**

1. Pan the map until the location you wish to route to is displayed.
2. Tap on the map at the point you want to go to. A red push pin will be displayed along with information about the point chosen at the top of the screen.
3. Tap the  button in the top left corner.
4. If an active route already exists, first you need to define what to do with this new route point:

Replace Destination: the next destination is cleared and replaced with the one selected from the Pan screen.

Go There Now: the selected location is inserted in the route as an intermediate destination before the next destination.

Add To Trip: the selected destination is added to the end of the current trip.

5. Tap the large GO  button on the right to return to the Map screen and begin navigating.

Note: if the panned position does not match an existing street address (i.e. the destination is not along a road or street that is stored in the map database), the guidance will stop on the road that is closest to your destination. A dashed line to your final destination will then be displayed on the map.

## Current Location Screen

The Current Location screen displays the approximate address of your current position, the next and previous intersections, your latitude, longitude, heading and elevation.

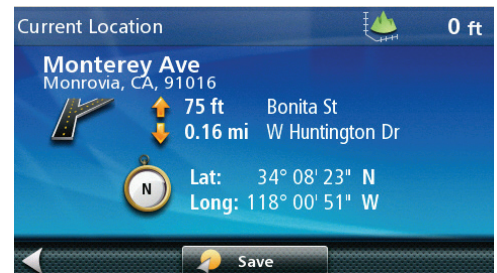

## Accessing the Current Location Screen

There are two ways to open the Current Location screen. From the Map screen:

1. From the Map screen tap on the current position icon .

## Saving Your Current Location to Your Address Book

1. From the Map screen tap on the current position icon .
2. Tap Save.
3. (optional) If you want to save this location to the OneTouch menu, select Add to OneTouch.
4. Edit information:

Tap the Name field and use the keypad to enter a name for the Address Book entry. (See above for details.)

(optional) Tap <Enter Phone Number> to specify a phone number for the address book entry.

5. When the details for this address are acceptable, tap . (Note: entering a Name is required before saving the Address Book entry.)
6. If you have selected to save this point to the OneTouch menu, you need to select a button for the entry.

## Maneuver List (Itinerary)

This screen is accessed from the Map screen and is available only when routing.

Each line in the Maneuver List provides details about the maneuvers in the order that they are to be made, with the next maneuver at the top.

The Maneuver List can be modified if you want to exclude one of the maneuvers should you want to avoid travelling on one of the streets listed. Instructions to exclude one of the maneuvers is described in this chapter.



## Accessing the Maneuver List

1. When actively following a route, tap the maneuver icon in the top left corner of the Map screen.

## ***Excluding a Maneuver***

This is used to modify the route to possibly avoid routing on a particular street.

1. Access the Maneuver List.
2. Tap the Avoid icon  for the maneuver you want to avoid.
3. Tap Yes to confirm.
4. The Magellan RoadMate receiver recalculates the route and the Map screen returns.

## ***Volume***

The volume can be adjusted or muted from the Map screen. (The volume can also be adjusted from Settings > Sound.)

## ***Changing the Volume from the Map Screen***

1. Tap the speaker icon . Additional controls appear.
2. Tap on the Mute button to mute the volume, or tap the '+' or '-' icons to change the volume levels.
3. Tap .



# Creating a Destination

## *Creating a Destination to an Address*

When creating an address, the first step is to enter the city.

The city can be specified by entering the name of the city, entering the ZIP code for the city or by selecting a previously used city.

1. From the Main Menu tap the Address icon.
2. Enter City:

You have three ways to do this:

To select the city from the list of previous cities, tap the previous destination button.

To enter a new city: use the keyboard to enter the first few characters of any significant word in the city name. If the city you are entering appears in the top field you can tap on the city name or the .

At any time you can tap on the List button to bring up a list of cities that begin with the characters you entered. Tap to select the city from the list.

To enter a ZIP code: if needed, tap the Zip Code button to switch to the numeric keyboard. Enter the ZIP code. Tap  to bring up a list of cities with the zip code entered.

3. Enter Street name:

With the city selected, the keyboard will be displayed prompting you for the street name.

Use the keyboard to enter the street name. It is not necessary to enter accented characters. Enter the first few characters of any significant word in the street name and tap the  or continue entering characters until the list of streets is displayed.

Tap on the street name from the list.

4. Enter Street number:

Use the keyboard to enter the street number for the address. The range of acceptable street numbers is displayed before you start typing. Tap the  when the street number is complete.

5. The GO screen appears with the address of the selected location, the estimated time of arrival (ETA), the distance to travel, and the routing method (e.g. Fastest Time).
6. (optional) Tap Options if you want to change the routing method.
7. Tap the large GO button on the right to return to the Map screen and begin routing.

8. Tip: If you know that you will use a destination later, before tapping the orange button you can tap Save to save it in your Address Book or in the OneTouch menu.

### ***Tips on Entering Addresses Quickly***

- When you are entering the name of a city or a street, Magellan software only displays those characters that appear in possible search results. The other characters are grayed out.
- When entering city names or street names, tap the List button after a couple of letters; Magellan software lists the items that contain the specified characters.
- You can also search by ZIP codes. This narrows the number of matching cities to normally less than four.

### ***Creating a Destination to an Intersection***

When the street number is not known, an intersecting street can pinpoint the location.

1. From the Main Menu, tap the Intersection icon.

2. Enter City:

You have three ways to do this:

To select the city from the list of previous cities, tap the  button.

To enter a new city: use the keyboard to enter the first few characters of any significant word in the city name. If the city you are entering appears in the top field you can tap on the city name or the .

At any time you can tap on the List button to bring up a list of cities that begin with the characters you entered. Tap to select the city from the list.

To enter a ZIP code: if needed, tap the Zip Code button to switch to the numeric keyboard. Enter the ZIP code. Tap  to bring up a list of cities with the zip code entered.

3. Enter Street name:

With the city selected, the keyboard will be displayed prompting you for the street name.

Use the keyboard to enter the street name. It is not necessary to enter accented characters. Enter the first few characters of any significant word in the street name and tap the  or continue entering characters until the list of streets is displayed.

Tap on the street name from the list.

4. Enter the second street:

Enter the name of the second street as you did the first street.

5. A screen appears with the address of the selected location, the estimated time of arrival (ETA), the distance to travel, and the routing method (e.g. Fastest Time).

6. (optional) Tap Options if you want to change the routing method.
7. Tap the large GO button on the right to return to the Map screen and begin routing.

### ***Creating a Destination to a City Center***

City Center allows you to select any city on the map as your destination. This option is particularly useful when you want to go to a city without having any specific address to select. (A route to a city center uses the geographical center of the city as the destination point.)

1. From the Main Menu, tap the City Center icon.
2. Enter City:

You have three ways to do this:

To select the city from the list of previous cities, tap the  button.

To enter a new city: use the keyboard to enter the first few characters of any significant word in the city name. If the city you are entering appears in the top field you can tap on the city name or the .

At any time you can tap on the List button to bring up a list of cities that begin with the characters you entered. Tap to select the city from the list.

3. To enter a ZIP code: if needed, tap the Zip Code button to switch to the numeric keyboard. Enter the ZIP code. Tap  to bring up a list of cities with the zip code entered.
4. A screen appears with the address of the selected location, the estimated time of arrival (ETA), the distance to travel, and the routing method (e.g. Fastest Time).
5. (optional) Tap Options if you want to change the routing method.
6. Tap the large GO button on the right to return to the Map screen and start navigating.

### ***Previous Destinations***

#### ***Routing to a Previous Destination***

1. From the Main Menu, tap the Previous icon.
2. Select the destination from the list of previous destinations.
3. A screen appears with the address of the selected location, the estimated time of arrival (ETA), the distance to travel, and the routing method (e.g. Fastest).
4. (optional) Tap Options if you want to change the routing method.
5. Tap the large GO button on the right to return to the Map screen and start navigating

#### ***Saving a Previous Destination to Your Address Book***

1. Access the list of Previous Destinations as described above.
2. Select the desired location from the list of previous destinations.

3. On the Go screen, tap Save.
4. The Edit Information screen is displayed. If you want to save this location to the OneTouch menu, select Add to OneTouch.
5. Edit information:

Tap the Name field and use the keyboard to enter a name for the address book entry.

(optional) Tap <Work, Cell or Home phone> to specify a phone number for the address book entry.

(optional) Tap List Categories to bring up a list of categories you have created for your address book. If the category you want isn't there, you can create one by tapping the "+ Add" button at the bottom of the screen.
6. When the details for this address are acceptable, tap the .
7. If you have selected to save this to the OneTouch menu, you be asked to select a the OneTouch button you want it assigned too.

### ***Clearing the list of Previous Destinations***

1. Access the list of Previous Destinations as described above.
2. Tap Delete All to clear the list.
3. To confirm the deletion, tap Yes.

### ***Address Book***

#### ***Accessing an Address in Your Address Book***

1. From the Main Menu, tap the Address Book icon.

To easily find the desired address you can tap the top left corner of the screen and narrow the list by the first letter of the address book entries.

#### ***Routing to an Address in Your Address Book***

1. Access the address record from your address book as described above.
2. Tap the GO icon of the desired address book entry. A screen appears with the address of the selected location, the estimated time of arrival (ETA), the distance to travel, and the routing method (e.g. Fast).
3. (optional) Tap Options if you want to change the routing method.
4. Tap the large GO button on the right to return to the Map screen and start navigating.

## ***Creating a New Entry in Your Address Book by Entering an Address***

1. From the Main Menu, tap the Address icon, and enter an address as described in “Entering an Address”.
2. When the screen appears with the address of the selected location, the estimated time of arrival (ETA), the distance to travel, and the routing method (e.g. Fast), tap Save.
3. Edit information:  

Tap the Name field and use the keyboard to enter a name for the address book entry.

(optional) Tap <Work, Cell or Home Phone Number> to specify a phone number for the address book entry.

(optional) Tap Assign to correct the location or to add text information to the address book entry.

If you want to save this location to the OneTouch menu, select Add to OneTouch.

(optional) Tap List Categories to bring up a list of categories you have created for your address book. If the category you want isn't there, you can create one by tapping the “+ Add” button at the bottom of the screen.
4. When the details for this address are acceptable, tap the .
5. If you have selected to save this to the OneTouch menu, you asked to select a the OneTouch button you want it assigned too.

## ***Creating a New Entry in Your Address Book from a POI***

1. From the Main Menu, tap the POI icon, and search for a POI as described in “Creating a Route to a POI by Category/Name.”
2. When the list of POIs appear, tap on the desired POI, and tap Save from the Route Method display.
3. Edit information:  

Tap the Name field and use the keyboard to enter a name for the address book entry.

(optional) Tap <Work, Cell or Home Phone Number> to specify a phone number for the address book entry.

(optional) Tap Assign to correct the location or to add text information to the address book entry.

If you want to save this location to the OneTouch menu, select Add to OneTouch.



(optional) Tap List Categories to bring up a list of categories you have created for your address book. If the category you want isn't there, you can create one by tapping the “+ Add” button at the bottom of the screen.

4. When the details for this address are acceptable, tap the .
5. If you have selected to save this to the OneTouch menu, you asked to select a the OneTouch button you want it assigned too.

# OneTouch Menu

In addition to Home Address, there are other icons in the OneTouch Menu. There are predefined bookmarks as well as user assignable bookmarks for searches and favorite destinations. They can be used for easy access of frequent destinations and to get local information when needed. Furthermore, you can assign POI search criteria to OneTouch icons. The OneTouch menu now has two tabs at the top of the display; Home and Travel. Each tab can be used independently of each other to help in categorizing your destinations and searches.

## ***Saving an Address to a OneTouch Icon***

1. Tap the  button in the top right corner of the Map screen. The OneTouch menu appears.
2. Tap one of the Assign icons.
3. Tap Location.
4. Using the keypad, enter the address (city, street and number) for the OneTouch icon.
5. When the address is complete you are prompted to enter a name for the button.
6. Using the keypad, enter a name for the button and tap .
7. Verify that the address has been added by going to the Map screen and accessing the OneTouch menu.





## ***Changing the Address or Search of a OneTouch Icon***

1. Tap the  button in the top right corner of the Map screen. The OneTouch menu appears.
2. Tap the Edit button.
3. Tap on the OneTouch button you want to edit.
4. Tap on the Re-assign button.
5. Tap Yes to confirm.
6. Follow the instructions for assigning a OneTouch button.

## ***Saving a POI Search Criteria to a OneTouch Icon***

Besides frequently visited destinations, you can also save POI search criteria to a OneTouch button. For example you may frequently search for coffee shops near your location or gas stations along your route. You can save these searches for later use.

1. Tap the  button in the top right corner of the Map screen.
2. Tap one of the Assign buttons.
3. Tap Search.
4. Tap one of the POI categories in the list.
5. If the next screen contains a list of subcategories, tap one of the POI subcategories in the list to further narrow the search, or tap "Any xxx" to see the list of all nearby POIs from the selected main POI category.
6. Repeat selecting subcategories until the list of POIs appear. (The list of POIs are shown with the closest POI to your current position on top.)
7. Tap Save.
8. Using the keypad, enter a name for the button and tap .

### ***Setting a Route to a OneTouch Icon***

With the OneTouch menu set up you can now go to a saved address or search.

1. Tap the  button in the top right corner of the Map screen.
2. Tap one of the assigned OneTouch buttons.
3. If the assigned button is for a search, the list of POIs is displayed. Tap on the desired POI.
4. The "Preview" icon at the bottom of the display allows you to step through the available POIs while viewing their location on the map.

The "Near..." button allows you to select how the list is sorted (nearest your current position, nearest a city you define or near an address you enter).

5. Whether the destination was chosen from a list of POIs or by an address, the GO screen is displayed (unless you are already on a route – see below). Tap on the Go button to begin the route.

Note: if you are already on a route you will be asked if you want to:

Replace Destination — this cancels the previous route and replaces it with a new route to this destination.

Go There Now — this inserts the destination in the route as the next destination and you will begin routing there. Once that destination has been completed, the receiver will begin routing to the next destination in the list.

Add To Trip — places the destination at the end of the trip. When the final destination of the current trip has been arrived at, the receiver will begin routing to the destination you are inputting now.



The Save button saves the destination, not the trip.

After selecting one of the three options, the Multiple Destination List is displayed. You can 'drag n drop' the displayed destinations to any order desired. Tap 'Optimize' to have the receiver compute the fastest method for completing the trip when the order of the destinations is not important.

Confirm the trip by tapping the Go button.

# Points of Interest (POI)

The Magellan RoadMate receiver has preloaded POIs that can be used as a destination for a route. Selecting a restaurant or finding a gas station nearby is at your fingertips.

## ***Creating a Route to a POI by Category***

POIs are categorized into unique categories from gas stations to tourist attractions. Most, but not all categories are further organized into subcategories. Restaurants have, for example, several subcategories that provide a way to search for restaurants serving Chinese food, fast food, or other favorites.

1. From the Main Menu, tap the Points of Interest icon.
2. Tap one of the POI categories in the list.
3. If the next screen contains a list of subcategories, tap one of the POI subcategories in the list to further narrow the search.
4. POIs near your current position are displayed. You can tap "Near..." for different search criteria (Near Current Position, Near City, or Near Address).
5. If you select Near City or Near Address you will need to enter the city or address information.
6. Select the POI desired from the list of POIs.
7. The 'Go' screen appears with the address of the selected location, the estimated time of arrival (ETA), the distance to travel, and the routing method (e.g. Fastest Time).
8. (optional) Tap Options if you want to change the routing method. You can select from Fastest Time, Shortest Distance, Mostly Freeways or Least Use of Freeways.
9. Tap the large Go button on the right to return to the Map screen and begin navigating to the POI selected.

## ***Creating a Route to a POI by Name***

1. From the Main Menu, tap the Points of Interest icon.
2. Tap the Search By Name button.
3. Spell the name of the POI to be used as the destination. You don't need to enter the full name, but the more characters you enter, the easier it will be to find the exact POI you are searching for. Tap .
4. POIs near your current position are displayed. You can tap "Near" for different search criteria (Near Current Position, Near City, or Near Address).
5. If you select Near City or Near Address you will need to enter the city or address information.

6. Select the POI desired from the list of POIs.
7. The 'Go' screen appears with the address of the selected location, the estimated time of arrival (ETA), the distance to travel, and the routing method (e.g. Fast).
8. (optional) Tap Options if you want to change the routing method.
9. Tap the large Go button on the right to return to the Map screen and start navigating.

### **Creating a Route to a Highway Exit POI**

The Highway Exit POIs function provides a way of accessing commonly used POIs that are near an exit you are approaching while travelling on a highway. Highway Exit POIs include restaurants, gas stations, car repair facilities and hotels. Freeway Exit POIs can be accessed while on a route or just driving, as long as you are on a freeway.

1. From the Map screen, tap the Highway Exit POIs button when it appears.
2. The list of the next freeway exits and their distance from your current position appear.
3. Small symbols represent the following service POIs near the exits:
  - Restaurants
  - Gas Stations
  - Car Repair
  - Accommodations



4. Tap any of the symbols to get a list of related POIs near the exit.
5. Select one POI from the list, and tap .
6. The 'Go' screen appears with the address of the selected POI, the estimated time of arrival (ETA), the distance to travel, and the routing method.
7. (optional) Tap Options if you want to change the routing method.
8. Tap the Go button on the right to return to the Map screen and begin routing to the POI selected.

# Home Address

Your most frequent destination can be entered and saved in the Magellan RoadMate as the Home Address for quick and easy access when you need to navigate there. This does not need to be your real home address. Choose any address you visit frequently. You can access it at any time with the first button of the OneTouch menu.

## ***Saving the Home Address***

These instructions only apply if you have never entered a home address.

1. Tap the  button in the top right corner of the Map screen. The OneTouch menu appears.
2. Tap the Home button.
3. Tap Yes to confirm that you want to enter your home address. (Tap 'Use My Current Location' if you want to store your home address using the GPS location.)
4. Using the keyboard, enter the desired address (city, street and number).

## ***Changing the Home Address***

These instructions only apply if a home address has already been entered.

1. Tap the  button in the top right corner. The OneTouch menu appears.
2. Tap Edit to enter editing mode.
3. Tap the Home button.
4. Tap the Re-assign button.
5. Tap Yes to confirm that you want to enter your home address.
6. Using the keyboard, enter the desired address (city, street and number).

## ***Creating a Route to the Home Address***

1. Tap the  button in the top right corner. The OneTouch menu appears.
2. Tap the Home button.
3. The display is returned to the Map screen and instructions for travelling to your home address are supplied. (Note when you are on a route, creating a route to your home replaces the route automatically.)



# Traveling on a Route

## Map Screen

When a route has been calculated, it will be displayed on the Map screen in green with small arrows indicating the direction of travel. The top of the screen displays the name of the street that comes next in your Turn List together with its distance. If you are not in the city in which the next street is, the name of the city is displayed instead.

As the route progresses, voice alerts will be used to prompt you of upcoming maneuvers.

### ***Maneuver List***

The Maneuver List displays all of the maneuvers needed to be made to complete the route and arrive at the destination. To view the Maneuver List, tap on the maneuver icon in the top left corner of the Map screen. (The Maneuver List is described in detail in the Map chapter of this manual.)

### ***Types of Routes***

There are a wide variety of methods you can use to create a route. Each method is discussed in the chapter which is associated with it.

### ***Routing Method***

Regardless of which route type has been created, the Magellan RoadMate needs to know how the route is to be calculated. Routes can be calculated by the following methods:

- Fastest Time (Fast): the fastest possible route provided the vehicle is able to travel at or near the speed limit.
- Shortest Distance (Short): the shortest possible route.
- Most Use of Freeway.
- Least Use of Freeway.

When a destination is selected, the Magellan RoadMate offers the route with the default selected routing method first.

1. To change the routing method, tap Options when the 'Go' screen is displayed. The Magellan RoadMate calculates the route with different methods.
2. Tap on the  icon to view the maneuver list for the route method desired.
3. Tap the desired routing method in the list, and the previous screen returns with the new calculation.

### ***To permanently change the routing method***

1. From the Main Menu, tap the Settings icon.
2. Tap Navigation Preferences.
3. Use the Route Method drop-down menu to select the default routing method desired.

## ***Special Routing Functions***

### ***Cancelling a Route***

1. From the Map screen, tap Menu.
2. On the Main Menu, tap the cancel route  icon.
3. Confirm that you want to cancel the route. Tap Yes.

OR

1. Tap the OneTouch icon from the Map screen to display the OneTouch menu.
2. Tap the cancel route  icon.
3. Confirm that you want to cancel the route. Tap Yes.

### ***Detouring off a Route***

1. From the Map screen, tap Menu.
2. Tap the Detour icon.
3. Different detours are calculated using the same routing method that was used to create the route. The list of alternate routes is displayed.
4. (optional) You can check the Maneuver List of an alternate route if you tap the  button on the right.
5. Tap the desired alternate route.

### ***SmartDetour™ on Freeways***

When you slow down under 20% of the speed limit on a freeway, after a few seconds the Magellan software assumes you are in a traffic jam and displays the Detour button on the Map screen.

1. Tap Detour.
2. Different detours are calculated using the same routing method that was used to create the route. The list of alternate routes is displayed.
3. (optional) You can check the Maneuver List of an alternate route if you tap the  button on the right.
4. Tap the desired alternate route.

# Multi Destination Routes

With the Magellan RoadMate you can create routes with more than one destination. Select one destination and create a single route first. Then turn it to a multi destination route by selecting additional destinations.

## ***Creating Additional Destinations with Go To***

Using the search functions of the Magellan RoadMate you can easily create a route with multiple destinations.

1. From the Main Menu, tap the Itinerary icon.
2. Tap Multiple Stop Trip.
3. Tap + Add.
4. Tap Address, POI, Previous, Address Book, Intersection, or City Center.
5. Select a new destination as described earlier.
6. If a route already exists, a new screen is displayed with Add Destination options (Replace Destination, Go There Now, or Add to Trip).

Replace Destination: the previous route is cleared, and a new route is calculated with the selected location as the destination.

Go There Now: the selected location is inserted in the route as the next destination.

Add To Trip: the selected location becomes the new destination with the previous destination as the last via point to reach.

7. The Multiple Destination List is displayed.
8. Tap on one of the addresses to move it up or down in the list.
9. Tap Optimize to optimize the route.
10. Tap + Add to put another destination in the route.
11. When done, tap .
12. A screen appears with the address of the next destination in the trip, the estimated time of arrival (ETA), the distance to travel, and the routing method (e.g. Fast).
13. (optional) Tap Options if you want to change the routing method.
14. Tap the large GO button on the right to return to the Map screen and start navigating.

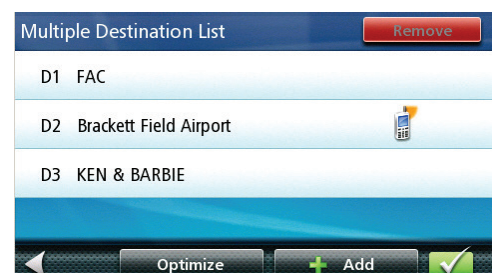



## Editing the Destination List

You can also edit a multi destination route without adding new destinations.

1. From the Map screen, tap Menu.
2. Tap Address Book icon.
3. Select the Trip from the list.
4. Tap on the direction list on the screen.
5. Tap on one of the addresses to move it up or down in the list.
6. Tap Optimize to optimize the route.
7. Tap Add to put another destination in the route.
8. When done, tap .
9. A screen appears with the address of the next destination in the trip, the estimated time of arrival (ETA), the distance to travel, and the routing method (e.g. Fastest).
10. (optional) Tap Options if you want to change the routing method or the vehicle type.
11. Tap the large GO button on the right to return to the Map screen and start navigating.

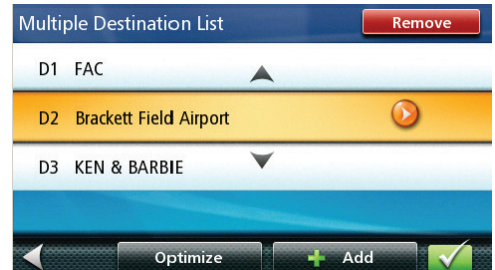

# Bluetooth

Please note that not all of the features of the Magellan RoadMate Bluetooth will work with all phones as features of cellular phones vary from manufacturer to manufacturer.

## ***Pairing your Bluetooth-ready Phone for the First Time***

Before you use the Bluetooth function of the Magellan RoadMate receiver you must pair your Bluetooth-ready phone to the RoadMate. A list of compatible phones can be found on the Magellan web site at [www.magellangps.com/support](http://www.magellangps.com/support). Before beginning you should have the instructions supplied with your phone for questions about accessing the Bluetooth pairing mode for your phone.

1. From the Map screen, tap the Bluetooth icon .
2. Tap the Settings icon.
3. Tap Pair Phone Now.
4. Enable Bluetooth on your phone. (See instructions supplied with your phone for any questions.)
5. On your phone, begin the searching for Bluetooth device function.
6. Select Magellan RoadMate from the list of devices found.
7. The Bluetooth phone will begin communicating with the Magellan RoadMate. When prompted, enter '1234' as the passcode on your phone.
8. Your phone may ask to connect to the Magellan RoadMate. (If not, refer to your phone manual for connecting to a Bluetooth device.)
9. When connected, the Magellan RoadMate will ask if you want to accept the connection. Tap Yes.
10. Wait while the communication is established.
11. You may now import contacts from your phone. Tap Yes to begin importing. (If you choose not to import your contacts now you can do so later from the Bluetooth Settings menu.)
12. You may need to confirm on your phone to accept connection from the Magellan RoadMate.
13. When the contacts have been successfully imported a confirmation screen is displayed.
14. The Bluetooth Settings screen is displayed.

## **Bluetooth Settings**

### **Accessing the Bluetooth Settings**

1. From the Map screen, tap the Bluetooth icon .
2. Tap the Settings icon.

### **Enabling/Disabling Bluetooth**

1. Access the Bluetooth Settings screen.
2. Check Enable Bluetooth to turn Bluetooth on; uncheck to turn Bluetooth off.

### **Enabling/Disabling Auto Connect**

1. Access the Bluetooth Settings screen.
2. Check Auto Connect to set the Magellan RoadMate receiver to auto connect to your paired Bluetooth phone when it is in range; unchecked turns off auto connect.

### **Enabling/Disabling Audible Maneuver Warning**

1. Access the Bluetooth Settings screen.
2. Check Audible Maneuver Warning to turn it on; uncheck to turn it off. (When Audible Maneuver Warning is enabled you will hear a beep when a maneuver is needed and you are in the middle of a phone conversation.)

### **Pairing Additional Bluetooth-ready Phone**

1. Access the Bluetooth Settings screen.
2. Tap Pair Phone Now.
3. Follow the instructions above for pairing a phone.

### **Importing Contacts**

1. Access the Bluetooth Settings screen.
2. Tap Import Contacts to begin importing contacts from your Bluetooth phone.



### **Calling Home**

1. From the Map screen, tap the Bluetooth icon .
2. Tap Call Home.
3. If your home phone number has not been set, a screen asking you if you want to enter your home phone number is displayed. Tap Yes. Enter your home phone number using the keypad. You will need to select Call Home again from the Phone menu.
4. If your home phone number is set, the Magellan RoadMate will initiate the call to the number stored.

## **Redial**

1. From the Map screen, tap the Bluetooth icon .
2. If there is a phone number that can be redialed it will appear in the second button (marked Redial).
3. Tap the Redial button.
4. The Magellan RoadMate will begin calling the number.

## **Manual Dialing**

1. From the Map screen, tap the Bluetooth icon .
2. Tap Dial Pad.
3. Using the keypad, enter the number you want to call.
4. Tap the green call button. .
5. The Magellan RoadMate will begin calling the number.

## **Dialing a Phone Number from the Address Book**

1. From the Map screen, tap the Bluetooth icon .
2. Tap Address Book.
3. Tap the Phone button at the top of the screen.
4. All the addresses in your address book are displayed with the phone icon displayed at the right for those addresses with phone number information.
5. Tap the dial icon on the right to begin placing the call. (The dial icon displayed will indicate if it's a work, home or cell phone number.)
6. The Magellan RoadMate will begin calling the number.

## **Speed Dialing**

### **Assigning a Phone Number to Speed Dialing**

1. From the Map screen, tap the Bluetooth icon .
2. Tap Speed Dial.
3. Tap an Assign button.
4. Enter the phone number or tap the Address Book button to select a phone number from your Address Book.
5. When the phone number is displayed at the top of the screen, tap the green checkmark.

## Speed Dialing a Phone Number

1. From the Map screen, tap the Bluetooth icon .
2. Tap Speed Dial.
3. Tap the button with the phone number you want to call.
4. The Magellan RoadMate will begin calling the number.

## Answering a Call

1. When your phone gets an incoming call, the Magellan RoadMate displays an Answer Phone screen. Tap the green button to answer the call or the red button to end the call.

## Available Options During a Call

When a call is connected the Connected screen is displayed. From this screen you can hang up, enter numbers for automated answer services, mute the call, and adjust the volume and microphone gain..

## Hanging Up

To hang up and disconnect the call, tap the red phone button on the Connected screen.

## Entering Numeric Data

When connecting to an automated answering service you are sometimes required to enter a number in response to an automated question. Tap the  button and a numeric keypad is displayed that can be used to reply.

## Setting Volume and Microphone Gain

If you are having trouble hearing the person on the call you can adjust the volume or if they are having trouble hearing you, adjust the microphone gain. (The higher the gain, the better they will hear you but they will also hear more road and background noise so you may need to try different settings for the best balance.)

1. Tap the Volume button.
2. Tap on the volume (top) slider to adjust the volume.
3. Tap on the microphone gain (bottom) slider to adjust the microphone gain.

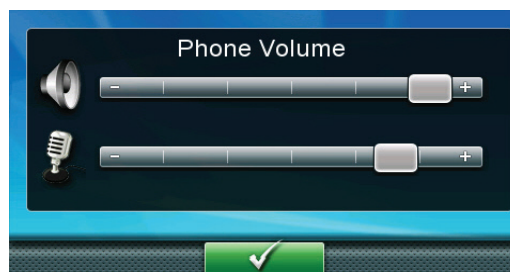
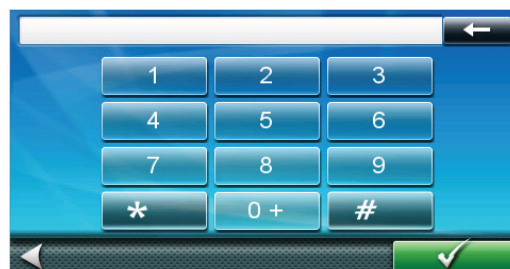
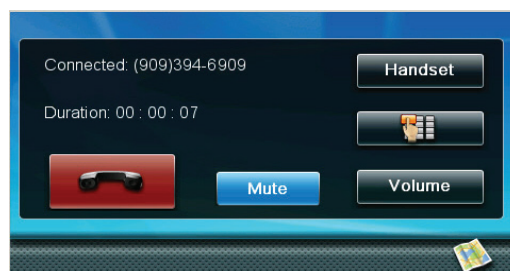

# Vehicle Profile

Set your vehicle profile so that when routes are being calculated you will not be routed over roads that your vehicle cannot travel on.

## **Accessing Vehicle Profile**

1. From the Map screen tap Menu.
2. Tap the Vehicle Profile icon.
3. You can choose not to use the Vehicle Profile by unchecking the box on the Vehicle Profile screen.

## **Set Vehicle Height**

1. Access the Vehicle Profile screen.
2. Tap the Height button.
3. Enter your vehicle height in inches.

## **Set Vehicle Width**

1. Access the Vehicle Profile screen.
2. Tap the Width button.
3. Enter your vehicle width in inches.

## **Set Vehicle Weight**

1. Access the Vehicle Profile screen.
2. Tap the Weight button.
3. Enter your vehicle weight in pounds.

## **Set Vehicle Total Length**

1. Access the Vehicle Profile screen.
2. Tap the Total Length button.
3. Enter your vehicle total length in inches.



### ***Set Vehicle Type***

1. Access the Vehicle Profile screen.
2. Tap the Vehicle Type button.
3. Select from available choices.

### ***Set Hazmat Type***

1. Access the Vehicle Profile screen.
2. Tap the Hazmat Type button.
3. Select from available choices (if applicable).

# Settings

With user Settings you can customize the Magellan RoadMate receiver to better suit your personal needs and preferences.

## ***Accessing System Settings***

1. From the Main Menu screen, tap the Settings icon.
2. Tap Sound.
3. Sound levels can be set for the navigation or the phone independently or together by using the "Master" slider.
4. Smart Volume adjusts the sound levels based on road noises.

## ***Setting Languages***

1. Access the System Settings menu (above).
2. Tap Languages.
3. Tap on the desired language.
4. Confirm the change.
5. Tap the back arrow .

## ***Setting Auto Power***

1. Auto power is the duration of time that the Magellan RoadMate receiver remains idle before turning off automatically.
2. Access the System Settings menu (above).
3. Tap Auto-Off.
4. Tap on the desired duration.
5. Tap the back arrow .

## ***Setting Brightness***

1. Access the System Settings menu (above).
2. Tap Brightness.
3. Tap in the brightness slider to set the brightness of the display for either day or night use.
4. Tap the back arrow .

The Dim on Battery Power option will prolong battery life by dimming the display while using internal battery power. Check to turn this option on.



### **Setting the Time Format**

1. Access the System Settings menu (above).
2. Tap Time Format.
3. Tap on 24 Hours or 12 hours with am/pm.
4. Tap the back arrow .

### **Selecting the Time Zone**

1. Access the System Settings menu (above).
2. Tap Time Zone.
3. Check Auto Time Zone or select your time zone from one of the cities in the list.
4. Tap the back arrow .

### **Selecting Units of Measure**

Auto power is the duration of time that the Magellan RoadMate receiver remains idle before turning off automatically.

1. Access the System Settings menu (above).
2. Tap Units.
3. Tap on the desired unit of measure.
4. Tap the back arrow .

### **Map Options**

#### **Setting Auto Night Map Display**

Normally the map is displayed in vivid colors for daytime use and with dark tints for night use. You can select whether to always use daytime colors, night color or let the Magellan RoadMate receiver switch between them automatically a few minutes before sunrise and a few minutes after sunset.

1. From the Main Menu screen, tap the Settings icon.
2. Tap Map.
3. Tap Night Mode to select Automatic for the timed adjustment, on always or off always.



### ***Setting Heading Up or North Up in 2D Mode***

1. From the Main Menu screen, tap the Settings icon.
2. Tap Map.
3. Tap 3D, 2D Heading Up or 2D North Up to toggle between settings.

### ***Assigning Visible POIs***

To avoid cluttering of the map, the POI icons that are displayed on the map can be turned on or off.

1. From the Main Menu screen, tap Settings.
2. Tap Map.
3. Tap POI Visibility.
4. Use the POI Selection screen to check those POIs you want shown and uncheck those you want hidden.

### ***Setting Auto Zoom on Turns***

You can set the map to automatically zoom in to the lowest level when coming up to a turn.

1. From the Main Menu screen, tap the Settings icon.
2. Tap Map.
3. Checking Auto Zoom on Turns enables this function.

### ***Setting Highway Lane Assist***

When Highway Lane Assist is checked, the map will display highway signs as you approach a highway interchange giving you visual indication of which lane you want to be in.

1. From the Main Menu screen, tap the Settings icon.
2. Tap Map.
3. Checking Highway Lane Assist enables this function.

### ***Sound***

#### ***Setting Volume from Settings***

1. From the Main Menu screen, tap the Settings icon.
2. Tap Sound.
3. Tap inside the volume slider bar to set the desired volume level.

### ***Muting the Sound***

1. From the Main Menu screen, tap the Settings icon.
2. Tap Sound.
3. Checking Mute will mute all sounds.

### ***Turning off Button Sounds***

1. From the Main Menu screen, tap the Settings icon.
2. Tap Sound.
3. Unchecking Button Sounds will turn off the audible indication that a button is tapped.

### ***Navigation Preferences***

#### ***Setting The Default Route Method***

1. From the Main Menu screen, tap the Settings icon.
2. Tap Navigation Preferences.
3. Use the drop-down menu to select the default routing method.

#### ***Setting The Turn Warning Alert Sounds***

1. From the Main Menu screen, tap the Settings icon.
2. Tap Navigation Preferences.
3. Use the drop-down menu to select the default sound you want played when alerting you to a turn.

#### ***Enabling U Turn Guidance***

1. From the Main Menu screen, tap the Settings icon.
2. Tap Navigation Preferences.
3. Checking Enable U Turns will allow the receiver to use U turns when necessary to compute your route.

#### ***Avoiding Toll Roads***

1. From the Main Menu screen, tap the Settings icon.
2. Tap Navigation Preferences.
3. Checking Avoid Toll Roads tells the receiver to avoid toll roads whenever possible.

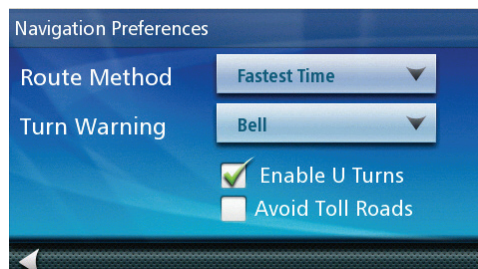

## **Keyboard**

### **Setting the Keyboard Layout.**

1. From the Main Menu screen, tap the Settings icon.
2. Tap Keyboard.
3. Select QWERTY (default) or ABC keyboard layouts.

## **GPS Options**

### **Setting the GPS Position**

It is useful to set a GPS position if you are not receiving satellite information quickly due to travelling over 800 km/500 mi with the Magellan RoadMate receiver turned off. Setting the GPS position will allow the Magellan RoadMate receiver to compute which satellites are available and calculate the position more quickly.

1. From the Main Menu screen, tap the Settings icon.
2. Tap GPS Options.
3. Tap Set GPS Position.
4. Enter an address as you were selecting a destination.

### **Viewing the GPS Status**

1. From the Main Menu screen, tap the Settings icon.
2. Tap GPS.
3. Tap Status.
4. (Optionally you can tap on the satellite signal indicator in the upper right corner of the OneTouch screen to access the GPS Status screen.)

## **Default System Settings**

### **Restoring All Default System Settings**

It is useful to set a GPS position if you are not receiving satellite information quickly due to travelling over 800 km/500 mi with the Magellan RoadMate receiver turned off. Setting the GPS position will allow the Magellan RoadMate receiver to compute which satellites are available and calculate the position more quickly.

1. From the Main Menu screen, tap the Settings icon.
2. Tap GPS.
3. Tap Set GPS Position.  
Enter an address as you were selecting a destination.

## ***Viewing Product Information***

1. From the Main Menu screen, tap the Settings icon.
2. Tap Product Information.

(Note: Scroll down the page to view the Serial Number and Software Version.)

## ***Speed Warnings***

1. From the Main Menu screen, tap the Settings icon.
2. Tap Speed Warning.
3. Set Audible Warning on or off.
4. Set Visible Warning on or off.
5. The Visible checkbox determines if the speed limit icon is displayed on the screen.
6. Set the number of miles above the speed limit you want the warnings to be alerted.

## ***Regions***

1. From the Main Menu screen, tap the Settings icon.
2. Tap Region.
3. Select an available map that is installed in your receiver.

## Free Manuals Download Website

<http://myh66.com>

<http://usermanuals.us>

<http://www.somanuals.com>

<http://www.4manuals.cc>

<http://www.manual-lib.com>

<http://www.404manual.com>

<http://www.luxmanual.com>

<http://aubethermostatmanual.com>

Golf course search by state

<http://golfingnear.com>

Email search by domain

<http://emailbydomain.com>

Auto manuals search

<http://auto.somanuals.com>

TV manuals search

<http://tv.somanuals.com>