

Digital Systems

Digital Systems

Digital Systems

MDR 24/96

Digital Systems

QUICK START GUIDE



Digital Systems

Digital Systems

Digital Systems

24 TRACK/24 BIT, DIGITAL AUDIO HARD DISK RECORDER

MACKIE.
Digital Systems

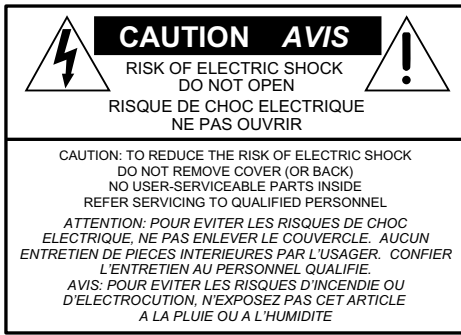

The lightning flash with arrowhead symbol within an equilateral triangle is intended to alert the user to the presence of uninsulated "dangerous voltage" within the product's enclosure, that may be of sufficient magnitude to constitute a risk of electric shock to persons.

Le symbole clair avec point de flèche l'intérieur d'un triangle équilatéral est utilisé pour alerter l'utilisateur de la présence d'intensité du courant de "voltage dangereux" non isolé d'ampleur suffisante pour constituer un risque d'électrocution.



The exclamation point within an equilateral triangle is intended to alert the user of the presence of important operating and maintenance (servicing) instructions in the literature accompanying the appliance.

Le point d'exclamation l'intérieur d'un triangle équilatéral est employé pour alerter les utilisateurs de la présence d'instructions importantes pour le fonctionnement et l'entretien (service) dans le livret d'instruction accompagnant l'appareil.

Important Safety Instructions

1. Read instructions — Read, understand and follow all safety and operating instructions before using the MDR24/96.
2. Retain Instructions — Keep these safety and operating instructions for future reference.
3. Heed Warnings — Follow all warnings on the MDR24/96 and in these operating instructions.
4. Water and Moisture — Do not use the MDR24/96 near water — for example, near a bathtub, kitchen sink, garden hose, incontinent poodle, sweaty drummer, etc. — or when condensation has formed on the unit.
5. Heat and Ventilation — Locate the MDR24/96 away from heat sources such as radiators, campfires, compost pits, heliarc welders, magma flows, etc. Do not block MDR24/96 ventilation openings or install in spaces that prevent adequate air circulation to the unit.
6. Power Sources — Connect the MDR24/96 only to a power source of the type described in these operating instructions or as marked on the MDR24/96.
7. Power Cord Protection — Route power supply cords so that they are not likely to be walked upon, tripped over, or abraded by items placed upon or against them. Pay particular attention to cords at plugs, convenience receptacles, and the point where they exit the MDR24/96.
8. Object and Liquid Entry — Do not drop objects or spill liquids into the MDR24/96. Clean only with a damp cloth; do not clean with liquid or aerosol cleaners.
9. Attachments — Use the MDR24/96 with only the accessories specified in this manual.
10. Damage Requiring Service — The MDR24/96 should be serviced only by qualified service personnel when:
 - A. The power supply cord or the plug has been damaged; or
 - B. Objects have fallen onto, or liquid has spilled into the unit; or
 - C. The unit has been exposed to rain or water; or
 - D. The unit does not appear to operate normally or exhibits a marked change in performance; or
 - E. The unit has been dropped, or its chassis damaged.

11. Servicing — Do not attempt to service the MDR24/96. All servicing should be referred to the Mackie Service Department.
12. Lightning — Unplug the MDR 24/96 during lightning storms or when unused for long periods of time.
13. Grounding and Polarization — To prevent electric shock, do not use the MDR24/96 polarized plug with an extension cord, receptacle or other outlet unless the blades can be fully inserted to prevent blade exposure. Do not defeat the MDR24/96 grounding by plugging into an ungrounded receptacle or ground lift adapter.

This apparatus does not exceed the Class A/Class B (whichever is applicable) limits for radio noise emissions from digital apparatus as set out in the radio interference regulations of the Canadian Department of Communications.

ATTENTION — Le présent appareil numérique n'émet pas de bruits radioélectriques dépassant les limites applicables aux appareils numériques de class A/de class B (selon le cas) prescrites dans le règlement sur le brouillage radioélectrique édicté par les ministere des communications du Canada.

FCC Information

NOTE: This equipment has been tested and found to comply with the limits for a Class A digital devices, pursuant to Part 15 of the FCC Rules. These limits are designed to provide reasonable protection against harmful interference when the equipment is operated in a commercial installation. This equipment generates, uses, and can radiate radio frequency energy and, if not installed and used in accordance with the instruction manual, may cause harmful interference to radio communications. Operation of this equipment in a residential area is likely to cause harmful interference in which case the user will be required to correct the interference at his own expense.



This product has been tested and complies with the following standards and directives as set forth by the European Union:

- * EN 55022 Radiated and Conducted Emissions
- * EN 61000-4-2 Electrostatic Discharge Immunity
- * EN 61000-4-3 RF Electromagnetic Fields Immunity
- * EN 61000-4-4 Electrical Fast Transient/Burst Immunity
- * EN 60950/IEC 950 Electrical Safety Requirements

WARNING — To reduce the risk of fire or electric shock, do not expose this appliance to rain or moisture.

WARNING — Before applying power to the MDR24/96, make sure that the Voltage Selector switch next to the AC inlet jack on the rear panel is set to the line voltage used in your region. Powering-on the MDR24/96 with the Voltage Selector switch set incorrectly will cause an electrical and fire hazard that may result in irreparable damage to the unit.

Contents

Introduction -----4

- Save your Box! ----- 4
- How To Use This Guide ----- 4
- Conventions ----- 5
- About “Tape” ----- 5
- Overview ----- 6

Setup & Configuration -----7

- Required Equipment ----- 7
- Installation ----- 7
 - I/O Cards & Cables ----- 8
 - Sync Card & Cables - Word Clock and Digital Synchronization ----- 10
 - Mackie Media (Optional) ----- 12
 - Remote 24 / Remote 48 (Optional) ----- 13
 - Footswitch (Optional) ----- 13
- Power-Up ----- 13
- Configuration ----- 14
 - I/O Cards ----- 14
 - Synchronization ----- 16
- Hookups ----- 18
 - Analog Hookup (AIO•8) ----- 18
 - TDIF Hookup (DIO•8) ----- 20
 - ADAT Optical Hookup (DIO•8 or OPT•8) ----- 22
 - AES/EBU Hookup (PDI•8) ----- 25

MDR24/96 Operation -----27

- Opening Projects ----- 27
- Time Display ----- 28
- Basic Transport Operations ----- 28
- Locate Points and Looping ----- 29
- Track Editing ----- 30
 - Cut / Join ----- 30
 - Copy ----- 30
 - Paste / Insert ----- 30
 - Undo / Redo ----- 30
- Creating Projects ----- 31
- Monitoring ----- 32
- Metering and Setting Record Levels ----- 33
- Recording ----- 34
- Footswitch Operation ----- 35
- Delete Last ----- 36
- Saving Projects ----- 36
- Project Backup / Restore ----- 37
- Purge Audio ----- 38

Appendix A: Compatible Cables ----39

- Analog and Digital Multitrack Cables ----39
- Other Cables ----- 40

Troubleshooting and service -----42

Notes -----43

Please write your serial number here for future reference:

Purchased at:

Date Of Purchase:



Manual Part No. 0000107 Rev. A1 08/01
 © 2001 Mackie Designs Inc., All rights reserved
 Printed in the U.S.A.

Introduction

Save your Box!

Uncle Jeff's Bottom Ten Reasons to Save the Box:

10. You think boxes grow on trees?
9. It's actually a time capsule, packed with a biological code that can't be decrypted until 2043.
8. Its festive graphics will cheer up those other boxes forgotten in your attic.
7. Impress your friends: tape it up and pretend that you actually have two MDR24/96s.
6. If you throw it away, bad people will know you have a studio in your house.
5. Someday, when paper costs more than steel, it could net you a fortune.
4. The MDR24/96 itself only costs \$47.95. The balance is what you paid for the box.
3. Properly sealed, it can be used as a flotation device in the unlikely event of a water landing.
2. It's a great place to hide your old digital 8-track recorder.
1. If you collect ten MDR24/96 boxes, Greg will come over for dinner (this offer does not apply to dealers or distributors).

In the unlikely event that you should need to send the MDR24/96 back to Mackie for service, please use the shipping box it came in. This box has been specially designed to minimize damage to the MDR24/96 during shipping, so that it won't end up more broken than when you sent it.

How To Use This Guide

Welcome to the cutting edge of affordable multitrack recording and editing! We know you're feeling eager, but please take a few minutes and read this brief Quick Start Guide before you jump into your first MDR24/96 session. The first part of this guide explains how to install and configure the various MDR24/96 I/O cards and connect the MDR24/96 to an analog or digital console. The second part describes how to start a session, operate the basic transport and monitoring controls, and explains the terms and conventions used to name, store, and retrieve projects on disk.

We have purposely excluded all the extra stuff from this guide to give you just the basic information you need to get going right away. For step-by-step tutorials, in-depth feature descriptions, and endless technical details, see the MDR24/96 Technical Reference Manual on the companion CD-ROM. Updated manuals and the latest software releases can be obtained via Mackie's website at: www.mackie.com.

Conventions

The MDR24/96 Quick Start Guide uses the following conventions to help you find information quickly:

Text Conventions

- a) File or folder names (example: *C:\HDR Projects\Ode To Masters\Ode To Masters.hdr*)
- b) Software or hardware controls (example: **Punch**)
- c) Proper names of objects in GUI or front/rear panel (example: **Transport**)

Icons



This icon identifies in-depth explanations of features and practical tips. Though not required reading, they do offer some choice tidbits of knowledge that will leave you wiser for the reading.



This icon identifies information that is critically important to the operation of the MDR24/96. So for your own sake, please read these sections.

About “Tape”

No, you're not reading the wrong manual. Our goal was to build a hard disk recorder that is comfortable for someone familiar with tape recording, but that doesn't require you to get a brain transplant from a computer geek to use. When familiar terms such as Tape Inputs, Tape Returns, Transport, and the like are applied to the MDR24/96, they mean exactly what you expect them to mean. Where the well-worn shoe fits, we continue to wear it.

Overview

By combining traditional multitrack tape recording features with the power and flexibility of hard disk recording, the Mackie Designs MDR24/96 takes multitrack recording to a level never before achieved by a product in its price range. In addition to the standard battery of traditional tape-based features, the MDR24/96:

- Combines the familiarity of a multitrack tape machine with the security of non-destructive recording and non-degrading recording media.
- Records simultaneously on all 24 tracks at 44.1 or 48 kHz and on 12 tracks at 88.2 or 96 kHz. At 48 kHz the internal hard drive stores over 2200 track-minutes of 24-bit audio (90 minutes of 24 full tracks). That's more than six reels of 2" tape at 30 inches per second! At 96 kHz the drive stores 1100 track-minutes of 24-bit audio (45 minutes of 24 full tracks).
- Has eight Virtual Takes per track, allowing you to record multiple passes without having to change routing and bussing assignments or use additional tracks.
- Interfaces with any analog or digital console. The MDR24/96 uses the same I/O cards as the Mackie Digital 8•Bus console: the AIO•8 (24-bit analog A/D and D/A), DIO•8 (TDIF/ADAT Optical), PDI•8 (AES/EBU), and low-cost OPT•8 (ADAT Optical).
- Provides three convenient methods of backup: Mackie Media M•90, a removable hard drive (also capable of 24-track recording and playback), Mackie Media PROJECT, a removable drive using inexpensive, removable 2.2 GB ORB cartridges; and data transfer to another computer through the MDR24/96's 100 Base-T Ethernet port via the built-in FTP server.
- Offers two optional remote control devices – the compact Remote 24 for smaller project studios, and the full-featured Remote 48 for controlling up to 48 tracks on two MDR24/96 recorders.

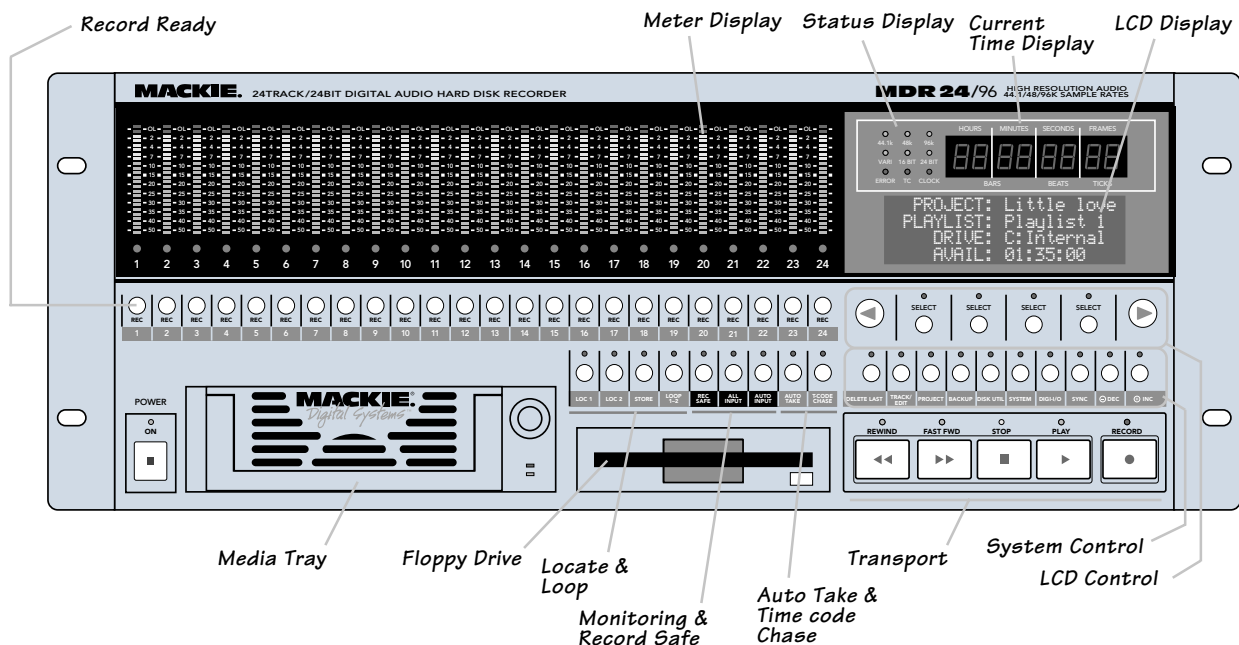

Setup & Configuration

This chapter explains how to set up and configure the MDR24/96 for use in your studio. Two application examples show how to interface the MDR24/96 with analog and digital recording consoles.

Required Equipment

Of course, there's more to a studio than a recorder and some musicians. At a minimum, you'll need the following to make the MDR24/96 feel at home:

- 3 Mackie 8-channel I/O (input/output) cards.
- A console with a minimum of 24 tape sends (busses or direct outputs) and returns (line inputs or monitor returns). If your analog console has only 8 tape sends, use Y-cord splitters to send tape out 1 to MDR24/96 Inputs 1, 9 and 17; tape out 2 to MDR24/96 Inputs 2, 10, and 18, and so forth.
- Cables to connect the MDR24/96 to the console: 3 or 6 multi-channel snakes or fiber optic cables, depending on your I/O setup.
- All the stuff that typically connects to a console: microphones, instruments, outboard equipment, control room monitors, and so on.

Installation

This section describes how to install the I/O cards and how to connect the MDR24/96 to your console. Before you begin, you should choose a location for your MDR24/96 considering the following:

- If you're not using the Remote 24, or Remote 48, position the front panel within convenient reach of your normal recording/mixing position. Be aware that although analog and AES/EBU cables can be fairly long, TDIF Optical and Remote 24/Remote 48 cables are limited to about 10 meters. ADAT Optical cables can reach up to about 15 meters.
- The MDR24/96 requires a reliable AC power source with a good ground. Do not use a ground lift adapter or plug the MDR24/96 into an ungrounded receptacle. Remember, this is a computer. Using an uninterruptible power supply (UPS) to power the MDR24/96 is a good idea to avoid an unexpected shutdown and protect it from transient line voltages.



Warning!

Before applying power to the MDR24/96, make sure that the Voltage Selector switch next to the AC inlet jack on the rear panel is set to the line voltage used in your region. Powering-on the MDR24/96 with the Voltage Selector switch set incorrectly will cause an electrical and fire hazard that may result in irreparable damage to the unit.

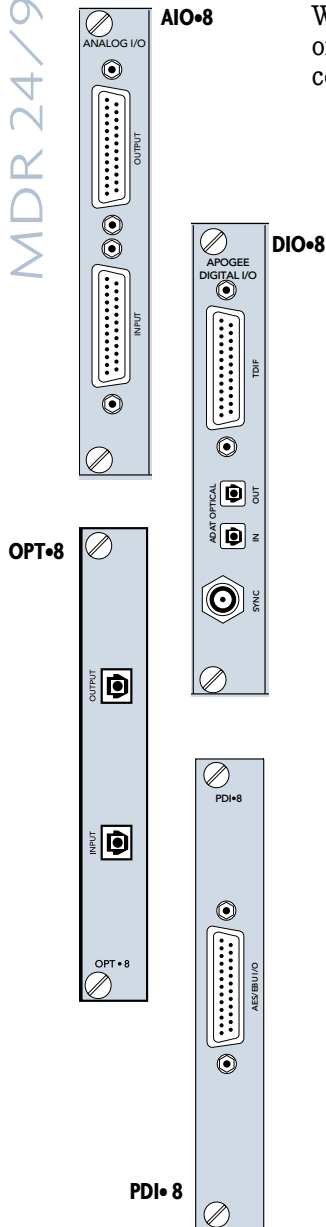

I/O Cards & Cables

While the MDR24/96 ships with AIO•8 cards already installed, three other flavors of I/O cards are also available. All I/O cards can be mixed and matched in any combination.

AIO•8

- Each AIO•8 provides 8 analog line-level inputs and outputs on two 25-pin D-subminiature (DB25) connectors. These connectors are pin-for-pin compatible with the analog (not TDIF) DB25 connectors found on the TASCAM DTRS recorders. DB25 cables that break out to XLR or 1/4" TRS connectors for mating with your console are readily available.

DIO•8

- Each DIO•8 provides 8 digital inputs and outputs in two formats:
 - TASCAM Digital Interface (TDIF) provides 8 input and output channels of digital audio on a single DB25 connector. It requires a TASCAM PW-88D or equivalent TDIF-compatible cable.
 - ADAT Optical provides 8 channels of digital audio on fiber-optic cable. Two optical cables are required for each card, one for inputs, the other for outputs. Both cables must connect to the same device, creating a closed loop.
 - The DIO•8 also provides a TDIF word clock sync output for use with older TASCAM equipment.

OPT•8

- The OPT•8 is a low-cost, ADAT Optical-only version of the DIO•8 card. The previous ADAT information also applies to this card.

PDI•8

- Each PDI•8 carries four stereo pairs (eight channels) of digital input and output on a single DB25 connector. This card supports the AES/EBU (IEC-958 Type 1) digital interfacing standard carrying two channels of digital audio on a single balanced cable. The PDI•8 can also be configured for the consumer (IEC-958 Type 2, or S/PDIF) data format if required. DB25 cables that break out to XLR connectors, and double-ended DB25 to DB25 AES/EBU cables for mating with your console, are readily available.

The PDI•8 is the only Mackie I/O card that currently supports 88.2 or 96 kHz operation. At these Sample Rates the PDI•8 card runs in "double-wide" (dual-wire) mode. In double-wide mode, the PDI•8 carries four mono channels of digital I/O by transmitting two consecutive 88.2/96k samples of the same channel on a single conductor.



Note: Different manufacturers use different wiring standards for DB25 interface cables (both analog and digital) that otherwise look the same. Make sure the cable you are using is the correct one. See Appendix A for a list of compatible MDR24/96 I/O card cables.

To replace the AIO-8 cards with different I/O cards:



1. If the MDR24/96 is plugged into AC power, unplug it.
2. Unscrew the thumbscrews at the top and bottom of each I/O card to be removed. Grasp one thumbscrew with each hand and gently pull the card out.

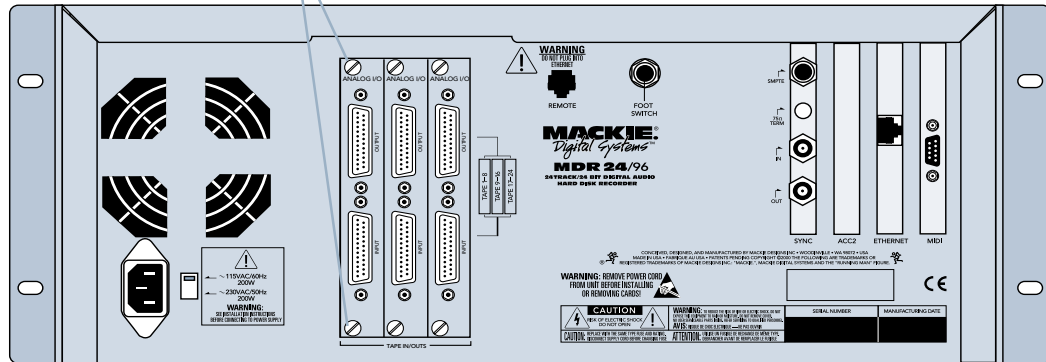

3. Before you take I/O cards from their bags, touch a grounded metal object to discharge any static electricity from your body.
4. Remove the new I/O card from its anti-static bag and put the I/O card you just removed from the MDR24/96 into the bag.
5. Hold the new card so the component side faces left and line up the top and bottom edges with the white card guides. Push the card all the way into the slot until its faceplate is flush with the back panel.
6. Hand-tighten the thumbscrews at the top and bottom of the card. Do not use a screwdriver.

If you want to hook up the MDR24/96 I/O cables to your console right now, see the console hookup diagrams in Hookups. Be sure to come right back here when you're done.

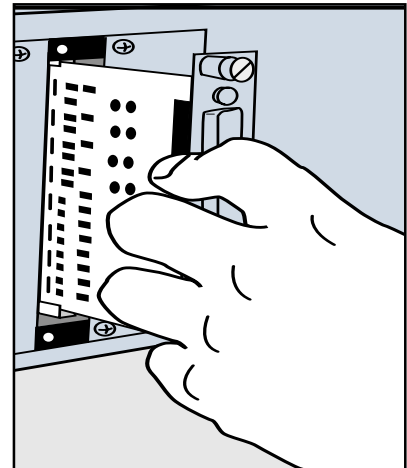

Note: Always hand tighten the thumbscrews at the top and bottom of all I/O cards before operating the MDR 24/96.

Sync Card & Cables - Word Clock and Digital Synchronization

The Sync Card provides ports to synchronize the MDR24/96's sample clock and time/transport position to other equipment. The functions of the jacks and switch, from top to bottom are:

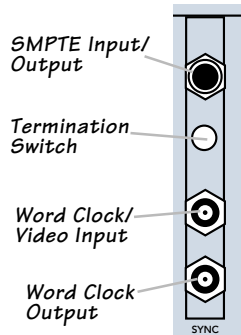

- SMPTE Input / Output – This 1/4" TRS jack serves as an input when slaved to incoming SMPTE time code, and as an output when generating SMPTE time code to synchronize other devices with the MDR24/96.
- Termination Switch – This pushbutton switch selects the termination impedance of the Word Clock / Video Input jack. When the switch is out, the impedance is 3.3kΩ (bridging); when in, the impedance is 75Ω (terminated).
- Word Clock / Video Input – This BNC jack receives either word clock, composite video, or video blackburst as determined by the MDR24/96 Sample Clock setting. Use this input when the MDR24/96 is operating as a word clock slave.
- Word Clock Output - This BNC jack transmits word clock to other devices in the system when the MDR24/96 is configured as the clock master.

Whenever digital audio connections are made between devices, the sample clock of every device must run at exactly the same rate. This is usually accomplished by selecting one device as the “master” clock source and distributing its word clock signal to all the “slave” devices in the system. The master is configured to run from its internal clock, and the slaves from external word clock. Some digital interfaces are self-clocking (such as the AES input on many DAT machines) and do not require a separate word clock connection. Others simply cannot be configured as slaves. The master/slave designation must be correctly made for each device to avoid the clicks and pops associated with asynchronous clocks.

Whenever time code (positional) synchronization is used, all the devices in a system, both analog and digital, must be synchronized to a common timing (speed) reference. This is often achieved by distributing video from a master video sync generator (sometimes called “house sync”) to all the slave devices in the system when word clock cannot otherwise be used. The MDR24/96, like many other digital devices, can synchronize its sample clock to a video signal. However, video does not provide enough timing precision to properly synchronize devices whose digital audio paths are interconnected; word clock must be used instead.

Generally it doesn't matter which device in a system serves as the word clock master, except when synchronizing to time code or video. For example, if your MDR24/96 Inputs and Outputs are connected to the Tape Inputs and Outputs of a Mackie Digital 8•Bus console using TDIF, either the MDR24/96 or D8B can be the word clock master. However, if you later synchronize the MDR24/96 to time code from a VTR, you must lock the VTR and MDR24/96 to a master video sync source and lock the D8B (which can't sync to video) to word clock from the MDR24/96. In this case the MDR24/96 becomes both a video slave and a word clock master. For more detailed information on setups involving video and time code synchronization, see the Technical Reference manual.



Note: For audio-for-video applications, the MDR24/96 can lock its word clock to a video signal. In this configuration, there must be only one word clock dependent device (The MDR24/96) locked to the video source. The MDR24/96 then becomes the word clock master for the other digital devices in the system (for example, a digital mixing console). Do not attempt to lock multiple digital devices to the video signal, or you'll get clicks.

The following are recommended setups for establishing proper sample clock synchronization with the devices connected to the MDR24/96 digital I/O cards.

TDIF (DIO•8)

With the MDR24/96 as a master, connect Word Clock Out of the MDR24/96 to Word Clock In on the receiving device(s). If connecting to older TASCAM DTRS recorders, use the Sync Out port on the first DIO•8 card instead of Word Clock Out. If there is more than one DTRS recorder in the chain, connect Sync Out to the word clock input of the first DTRS recorder only; the other recorders are synchronized through their interconnecting DTRS cables.

With the MDR24/96 operating as a slave to another TDIF device, connect the word clock output from the master TDIF device to Word Clock In on the MDR24/96.

ADAT Optical (DIO•8, OPT•8)

With the MDR24/96 as a master, set the receiving device(s) to derive sample clock from their ADAT Optical ports if the ports are self-clocking. In this case, no word clock connection is necessary. If the ADAT Optical ports on the receiving devices are not self-clocking, connect Word Clock Out of the MDR24/96 to Word Clock In on the receiving device(s).

With the MDR24/96 configured as a slave, connect the word clock out of the master ADAT Optical device to Word Clock In on the MDR24/96.

AES/EBU (PDI•8)

With the MDR24/96 as a master, set the receiving device(s) to derive their sample clock from the AES/EBU ports if the ports are self-clocking. In this instance, no word clock connection is necessary. If the AES/EBU ports on the receiving device(s) are not self-clocking, connect Word Clock Out of the MDR24/96 to Word Clock In of the receiving device(s).

With the MDR24/96 as a slave, connect the word clock out of the master AES/EBU device to Word Clock In on the MDR24/96.



Note: Use 75 Ω coaxial cables when connecting word clock or video to the Sync Card Word Clock/Video input jack. If the MDR24/96 is at the end of a cable that's connected to several devices, push the Termination Switch in; otherwise leave it out and use a BNC Tee adaptor to feed the signal on to the next device in the chain.

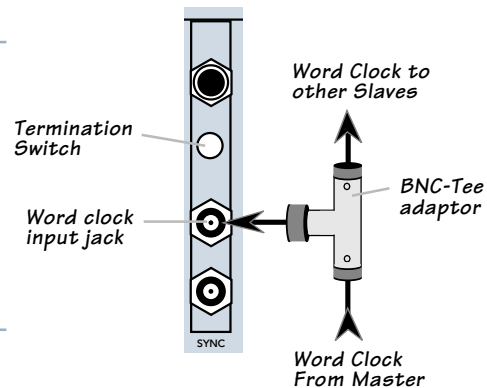

Note: If you are using an MDR24/96 with the Mackie Digital 8•Bus console, you may need to turn on the Digital 8•Bus first. The Clock I/O on the D8B prefers not to see an active signal at its Word Clock input when it powers up.

Mackie Media (Optional)

The MDR24/96 emulates the tape library tradition with Mackie Media M•90 and Mackie Media PROJECT drives. Both drives come complete with a plug-in tray for quick removal and a nifty storage case for shelving and transporting the drives. Trays can be purchased separately if you want to use your own UDMA IDE drives. The MDR24/96 can record or play directly off the M•90 so you can change sessions as quickly as changing tape on a 24-track – no backup time required. PROJECT drives are for backup only and use removable 2.2GB ORB cartridges that fit in your pocket. Each can hold a couple of 5-minute 24-track masters.

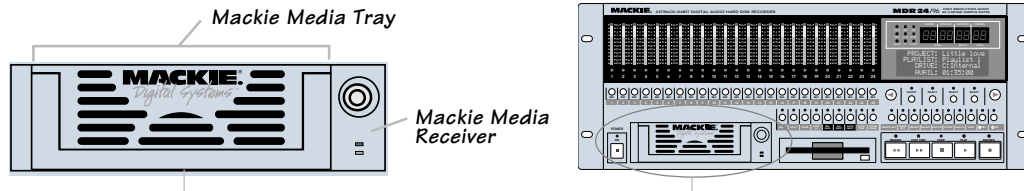

To install or remove a Mackie Media tray:



1. Power the MDR24/96 off whenever inserting or removing media trays.
If you have an active project, don't forget to save it first!
2. To remove a drive, first unlock it by inserting the key and turning it a quarter-turn counterclockwise. Two keys are packed with the recorder, and one with each M•90 drive.
3. Lift the bail handle to release the drive, and pull it out of the drive bay.
4. To install a new M•90 or PROJECT drive, slide the media tray into the front panel drive bay. Press it firmly into place, and latch it by pressing the bail handle downward until it's fully seated.
5. Insert the key into the lock and turn it a quarter-turn clockwise. The key locks the drive into place and powers the tray.
6. The MDR24/96 will automatically detect the Mackie Media drive when you next power it up.



Note: Mackie Media are hard drives, and as we all know, hard drives involve some pretty intricate technology. So don't shake the little darlin', and if a tray has just come in from a freezing car or airplane cargo hold, do not install it until it has reached room temperature.



Note: The Remotes duplicate nearly all of the front panel operating controls. When we describe a front panel operation, you'll probably find it available on the Remote also. If you have a Remote, try it both ways. If you don't have a Remote yet, think of how convenient it would be.

Remote 24 / Remote 48 (Optional)

Installing either remote is as simple as plugging in a telephone. Connect one end of the cable (supplied with the Remote) to the 'REMOTE' jack on MDR24/96 rear panel, and the other end to the 'TO HDR REMOTE JACK' jack on the Remote 24, or to the "TO HDR" jack on the Remote 48. It's OK to plug or unplug either Remote with the MDR24/96 powered on. However, if you plug the Remote 48 into the MDR24/96 while both are powered on, you must power cycle the Remote 48 to reset the connection.

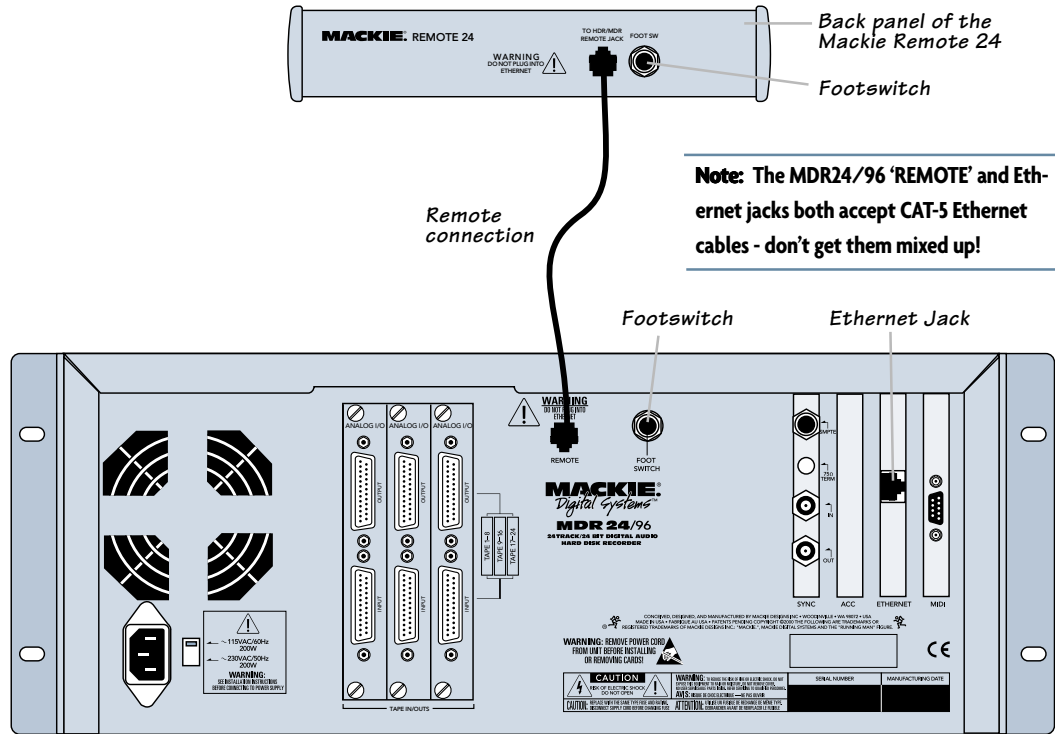

Note: If you are using an MDR24/96 with the Mackie Digital 8•Bus console, you may need to turn on the Digital 8•Bus first. The Clock I/O on the D8B prefers not to see an active signal at its Word Clock input when it powers up.

Footswitch (Optional)

For hands-free do-it-yourself punches and other frequently-used functions like Play/Stop, Punch In/Out and Take Select, connect the cable of a momentary, normally open footswitch to the 'FOOT SWITCH' 1/4" TS jack on the rear panel of the MDR24/96, the Remote 24, or Remote 48. If you have a Remote installed you can connect two foot switches, one to the MDR24/96 and one to the Remote. Each footswitch functions independently of the other. Footswitch functionality is assigned in the front panel System menu. See the MDR24/96 Technical Reference Manual for more details.

Power-Up

OK, NOW you can turn it on. Assuming you have already connected the MDR24/96 to your console, power up the MDR24/96 first, then the outboard equipment and console, and finally the power amplifiers or powered monitors. Audio equipment tends to generate unexpected clicks and pops when you power it up, so by powering up your monitoring system last, you'll save your speakers and your ears.

Before you read the next section, take a quick, self-guided tour of the front panel display and controls to get a sense of where they are.

Configuration

Before starting a Project, you will need to configure the MDR24/96 I/O card options and synchronization parameters. These parameters determine where the sample clock is coming from, how fast the sample clock runs, and how many bits are recorded in every sample. Some options, like sample rate and bit depth, will become “standards” that you won’t need to change very often. The remaining synchronization options (for time code and video) are covered in detail in the Technical Reference manual.

I/O Cards

Only the DIO•8 and PDI•8 cards require special configuration. If you are using AIO•8 or OPT•8 cards only, you can skip to the next section.

DIO•8 Card

To set the DIO•8 input and output formats:

1. Press **Digi I/O** to enter the Digital I/O Card Setup screen.

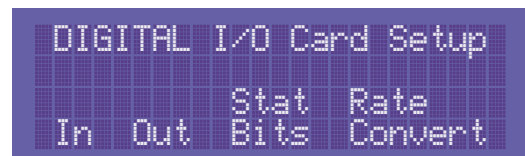
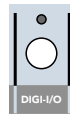

2. Select **In**.

The Setup Tape Inputs screen shows you the current input settings for each of the three I/O cards.

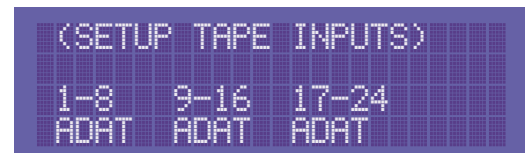

3. Press the **Select** button corresponding to each DIO•8 card and toggle the selection between **ADAT** and **TDIF**.

4. Press the **Page Left** (<) button to return to the previous screen.

5. Now select **Out**.

The Setup Tape Outputs screen shows you the current output settings for each of the three I/O cards.

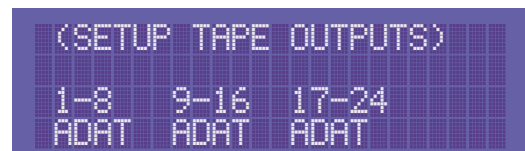

6. For each DIO•8 card present, press the **Select** button to select the desired output format. Or, select the **TD->AD** or **AD->TD** option to convert between formats, bypassing the MDR24/96 tape signal path entirely.

7. When done, press **Digi I/O** to exit the menu.



Note: The front panel display's backlight switches off after several minutes of inactivity. It'll come back on automatically when it's needed to display new information, but you can revive it at any time by pressing either the **Page Left** (←) or **Page Right** (→) button below the display.

PDI•8 Card

The PDI•8 card options include sample rate conversion for each stereo AES/EBU input, and status bit control (pro/consumer mode) for each output. When a PDI•8 card is first installed, its default settings are for sample rate conversion **Off**, and channel status bits set to indicate the **Pro** (AES/EBU) format. In most circumstances you won't need to change these settings. However, if the device(s) connected to the PDI•8 inputs cannot be made a clock master or slave (such as a CD player with a digital out), enabling sample rate conversion on each affected input will effectively re-clock the incoming data.

Occasionally you'll run across a device that will not recognize the digital audio output from the PDI•8 card. Changing the status bits on the affected output(s) from **Pro** to **Consumer** (S/PDIF) may solve the problem.

Remember that with the AES/EBU format, channels come in pairs, so rather than eight settings, you have four, one for each pair of channels.

To set the PDI•8 card options:

1. Press **Digi I/O** to enter the Digital I/O Card Setup screen.

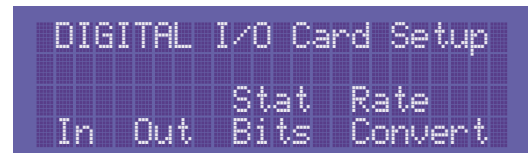
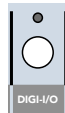

2. Select **Rate Convert**. The Sample Rate Convert screen shows you the Sample Rate Conversion settings for inputs 1-8.

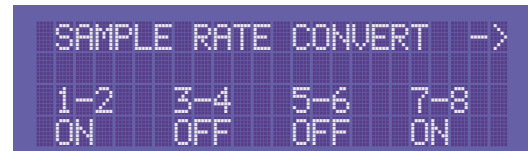

3. Press the **Select** button corresponding to the desired input channel(s) and toggle the selection. **On** enables sample rate conversion, **Off** disables it (default).

4. Press the **Page Right** (>) button to scroll to channels 9-16. Repeat the procedure for channels 9-16 and 17-24. Press **Page Left** (<) until you return to the Digital I/O Card Setup screen.

5. Select **Stat Bits**. The Setup Status Bits screen shows you the current Status Bit settings for outputs 1-8.

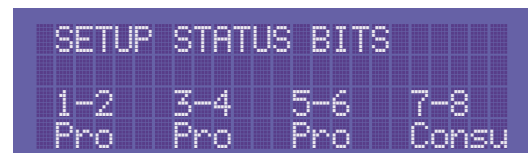

6. Press the **Select** button corresponding to the desired output channel(s) to toggle the selection between **Pro** (default) and **Consu**.

7. Press the **Page Right** (>) button to scroll to channels 9-16. Repeat the procedure for channels 9-16 and 17-24. Press **Digi I/O** to exit.



The PDI-8 is the only Mackie I/O card that currently supports 88.2 or 96 kHz operation. Do not operate the MDR24/96 at these Sample Rates with AIO-8, DIO-8, or OPT-8 cards installed. See Errata for more information



You must still select the MDR24/96's Sample Rate even if it's slaved to another device's clock. If you don't set it correctly, the MDR24/96 time display will run at the wrong rate, even though audio will play at the right speed.

Synchronization

Sample Clock

The Sample Clock setting determines the source of the MDR24/96 sample clock. If the MDR24/96 is a clock master or is not connected to any other digital device(s), set it to **Internal**. If the MDR24/96 is a word clock slave, set it to **Word Clock**. The **Video** setting is discussed in the Technical Reference Manual.

Sample Rate

The Sample Rate determines how fast the MDR24/96 sample clock runs. Compact Disks use a **44.1 kHz** sample rate, while some DVD disks use **96 kHz**. The video production folks prefer **48 kHz** because their digital video recorders use **48 kHz**. Even though the MDR24/96 supports four Sample Rates, you can only choose between two at any given time. The range of available rates is determined by the current Project's Sample Rate mode. The Sample Rate mode determines whether a Project will be a 24-track **44.1 kHz** or **48 kHz** Project, or a 12-track **88.2 kHz** or **96 kHz** Project. To change the Sample Rate to a setting that is not available, first create or open a Project with the desired Sample Rate mode.

Bit-Depth

The Bit Depth setting determines how many bits are contained in each audio sample recorded to disk (the bit "resolution"). While **16-Bit** audio takes up 1/3 less disk space than **24-Bit** audio, **24-Bit** audio offers the potential for greater dynamic range (the difference between the softest and loudest sounds that can be recorded) and captures a more accurate "image" of the sound.

Word Clock Divisors (88.2/96 kHz operation only)

Some devices that support double-wide AES at 88.2 and 96 kHz can only transmit or receive word clock at 0.5x the Sample Rate. The Word Clock divisors determine whether Word Clock In and Word Clock Out run at 1x or 0.5x the MDR24/96 Sample Rate. Both divisors can be set independently.

To configure the MDR24/96 synchronization settings:

1. Press **Sync** to enter the Sync Options menu. Select **Sample Clock**. Select either **Internal** or **Word Clock** according to your setup using the **(-)Dec / (+)Inc** or **<< / >>** buttons.
2. Select **OK** to return to the Sync Options menu.
3. Select **Sample Rate**. Using the **(-)Dec / (+)Inc** or **<< / >>** buttons, set the Sample Rate to **44.1 kHz** or **48 kHz** (**88.2 kHz** or **96 kHz**). Select **OK**.
4. Move to the third page of the Sync Options menu with the **Page Right (>)** button.
5. Select **Bit Depth**. Set the Bit Depth to **16 Bit** or **24 Bit** using the **(-)Dec / (+)Inc** or **<< / >>** buttons. Select **OK**.

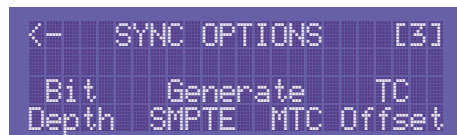

Sync Settings for 88.2/96 kHz operation only:

1. Move to the last page of the Sync Options menu with the **Page Right (>)** button. Select **SR/2 In**.
2. Set the Word Clock Input divisor to **On** or **Off** using the **(-)Dec / (+)Inc** or **<< / >>** buttons. **Off** selects 1x operation, **On** selects 0.5x operation.
3. Select **OK**, then Select **SR/2 Out** and set the Word Clock Output divisor to **On** or **Off**.
4. Select **OK** and press the **Sync** button to exit the menu.



```
<- SYNC OPTIONS [4]
Video SR/2 SR/2
Field In Out
```



```
SAMPLE RATE/2 OUT
ON
<< >> OK
```



Note: If you are using a D8B console with either DIO•8, PDI•8, or OPT•8 cards installed, then a Clock I/O card must also be installed in the D8B to properly synchronize its word clock with the MDR24/96.

Hookups

This section shows how the MDR24/96 is typically connected to both analog and digital consoles (using the Mackie Analog and Digital 8•Bus consoles as examples). These examples assume that the rest of your studio equipment (monitors, sound sources, outboard processing, etc.) is already connected, or that you know how to connect it.

Before you begin, note how the three eight-channel I/O cards are arranged on the MDR24/96 rear panel: 1-8 is on the left, 9-16 is in the center, and 17-24 is on the right. Labeling each cable before you begin will make connecting the MDR24/96 to your console easier.

The specific hookups for each MDR24/96 I/O card are shown below.

Analog Hookup (AIO•8)

This example describes the hookup for the 24•8 analog console.

Cables & Hardware

- (3) AIO•8 cards for MDR24/96
- (6) Analog snakes, DB25 to eight 1/4" TRS phone plugs

Hookup

1. Connect three snakes to the MDR24/96 Inputs (bottom connector). If you want to have the ability to route any console input to any recorder track, then connect the 1/4" plugs on each of the three snakes to the like-numbered Submaster / Tape Output jacks on the 8•Bus console. This works as long as you don't record more than 8-channels at a time, since the Submaster Outputs 9-16 and 17-24 are the same as outputs 1-8.

Alternately, you can connect the console's direct outputs to the recorder's inputs, so that each console channel feeds the like-numbered recorder track. Or, you can use a combination of direct and subgroup outs. The hookup diagram below shows the MDR24/96 inputs connected to the Submaster Outputs.

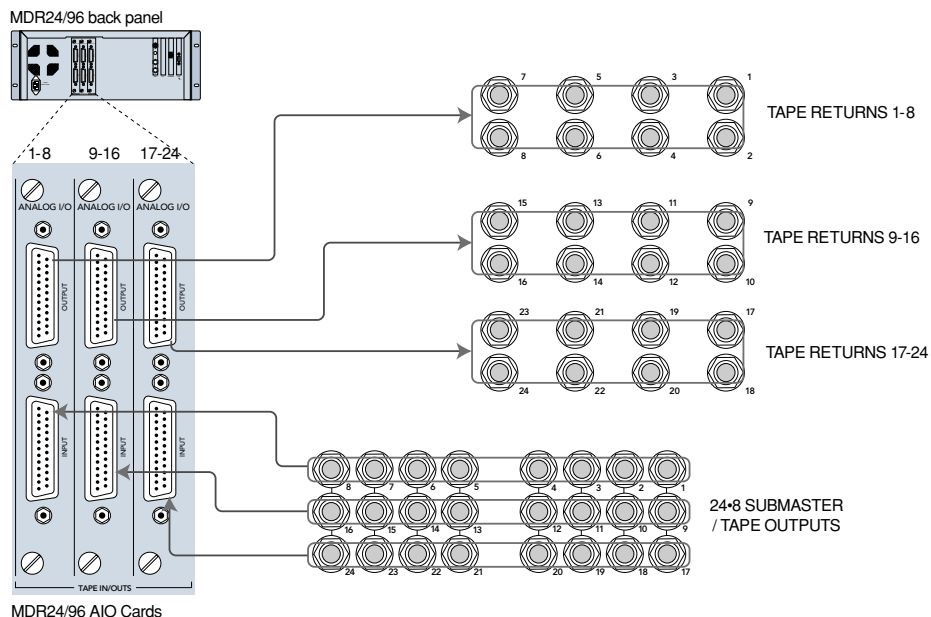

2. Connect three snakes to the MDR24/96 Outputs (top connector). Connect the plug end of the snakes to the like-numbered Tape Return jacks on the 24•8 console.

MDR24/96 Settings

1. Set the **Sample Clock** to **Internal**.
2. Set the **Sample Rate** and **Bit Depth** according to your preference.

Console Settings

Set the 24•8 console to the nominal +4 dBu operating level by setting the five Operating Level switches in the Sub Out and Tape Return sections to the 'out' position.

This example describes the hookup for the D8B console equipped for analog I/O.



Note: Some older AIO•8 cards have the Input jack labeled as "From Tape" and the Output jack labeled as "To Tape." Otherwise, they operate identically. Sigh ... long story.

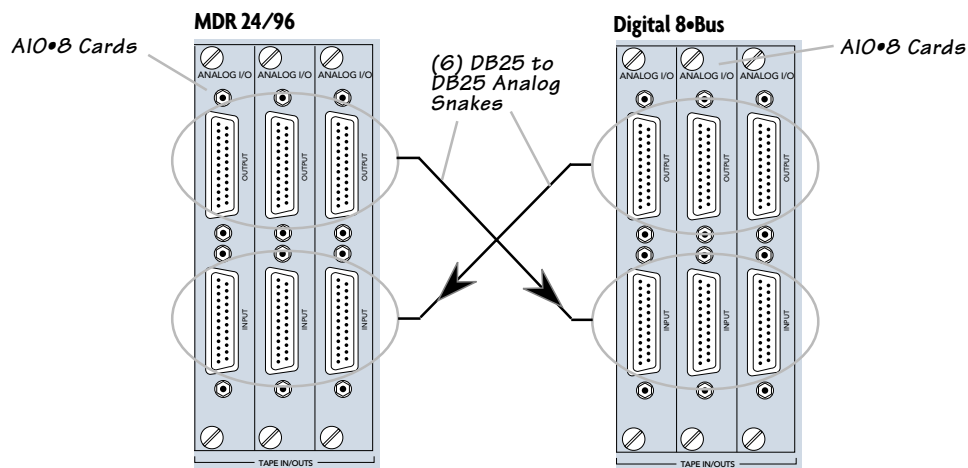

Cables & Hardware

- (3) AIO•8 cards for MDR24/96
- (3) AIO•8 cards for D8B
- (6) DB25 to DB25 analog snakes

Hookup

1. Connect three snakes between the MDR24/96 Inputs (bottom connector) and the corresponding D8B Tape Outputs (top connector).
2. Connect three snakes between the MDR24/96 Outputs (top connector) and the corresponding D8B Tape Inputs (bottom connector).

MDR24/96 Settings

1. Set the **Sample Clock** to **Internal**.
2. Set the **Sample Rate** and **Bit Depth** according to your preference. It is not necessary to set the D8B and MDR24/96 to the same **Sample Rate**, since with analog connections, the sample clocks on the two units are not synchronized

Console Settings

1. Set the D8B **Sample Clock** to **44.1 k Internal** or **48 k Internal** according to your preference.

TDIF Hookup (DIO•8)

Cables & Hardware

- (3) DIO•8 cards for MDR24/96
- (3) DIO•8 cards for D8B
- (1) Clock I/O card for D8B
- (3) TDIF cables
- (1) 75 Ω BNC word clock cable

Hookup

1. Connect the three TDIF cables between the corresponding TDIF jacks on the MDR24/96 and D8B.
2. When TDIF is used, the D8B must have a Clock I/O card installed. To make the D8B the clock master, connect its Word Clock Out (not DIO•8 Sync out) to the MDR24/96 Word Clock In. To make the MDR24/96 the clock master, connect its Word Clock Out to the D8B Word Clock In. See *Figure 1*.



Note: Determining which unit in *Figure 1* provides the master clock depends on your application. For information on advanced applications, see the *Applications Manual*.

MDR24/96 Settings

1. Set the Tape Input format for each DIO•8 card to **TDIF**, and the Tape Output format to **TDIF**.
2. If the MDR24/96 is the clock master, set the **Sample Clock** to **Internal**; if it is a clock slave, set it to **Word Clock** and depress the 75 Ω termination switch on the Sync card.
3. Set the **Sample Rate** to 44.1 kHz or 48 kHz according to your preference.

Console Settings

1. Set the Tape Input and Tape Output format for each DIO•8 card to **TDIF**.
2. If the D8B is the clock master, set the **Sample Clock** to either **44.1 k Internal** or **48 k Internal**; if it is a clock slave, set the **Sample Clock** to either **44.1 kHz** or **48 kHz**. Set the Sample Rate to match the **Sample Rate** selected on the MDR24/96.

TDIF Hookup with DIO-8

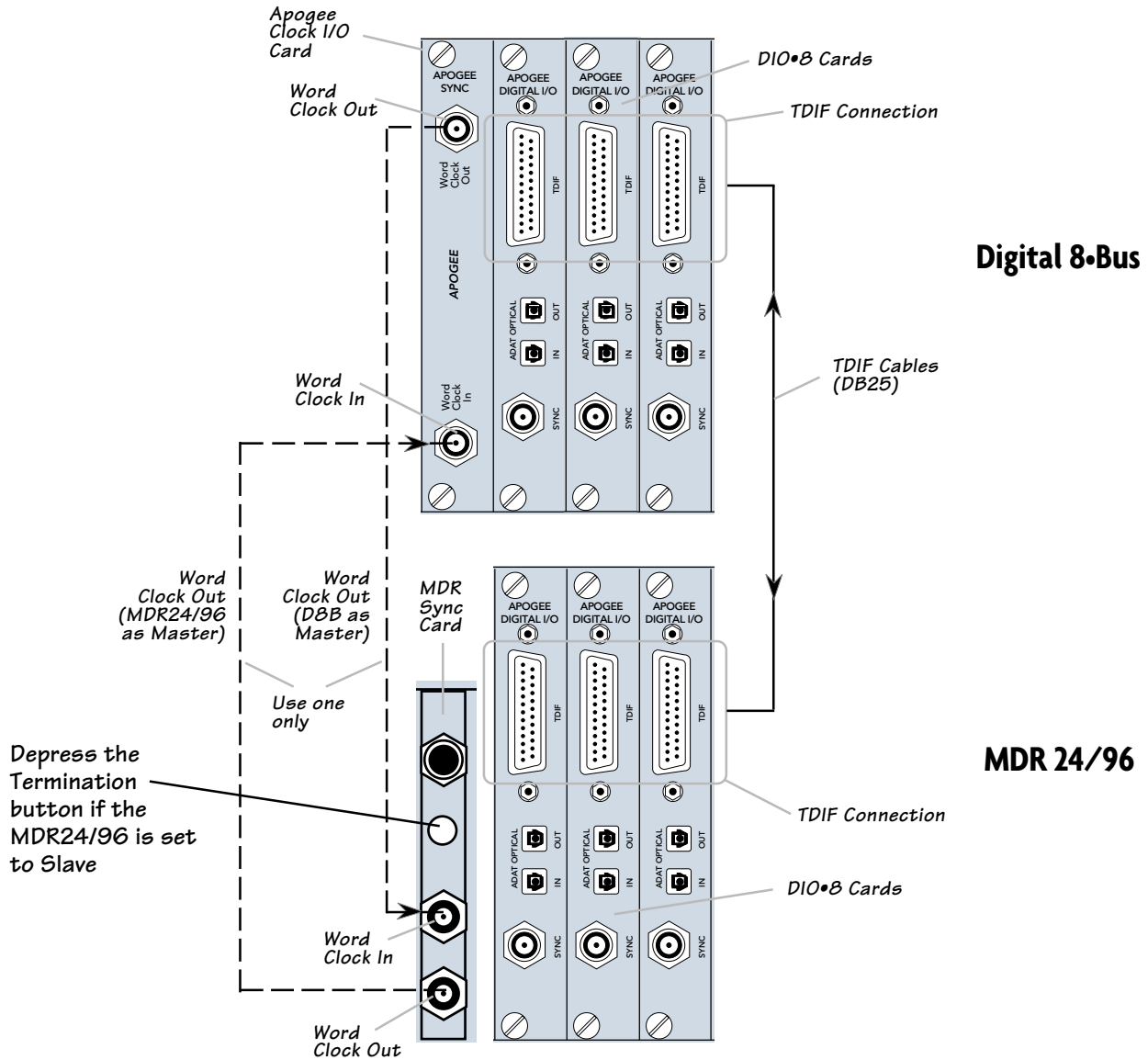

Note: The Word Clock connections shown here are the same for Figure 2, 3 and 4.

Figure 1

ADAT Optical Hookup (DIO•8 or OPT•8)

Cables & Hardware

- (3) DIO•8 or OPT•8 cards for MDR24/96
- (3) DIO•8 or OPT•8 cards for D8B
- (1) Clock I/O card for D8B
- (6) ADAT Optical cables
- (1) 75Ω BNC word clock cable

Hookup

1. Connect three ADAT Optical cables from the MDR24/96 Optical Outputs to the Optical Inputs on the corresponding D8B I/O cards.
2. Connect three ADAT Optical cables from the MDR24/96 Optical Inputs to the Optical Outputs on the corresponding D8B I/O cards.
3. When ADAT Optical is used, the D8B must have a Clock I/O card installed. To make the D8B the clock master, connect its Word Clock Out to the MDR24/96 Word Clock In. To make the MDR24/96 the clock master, connect its Word Clock Out to the D8B Word Clock In.



Note: Determining which unit in *Figures 2 & 3* provides master clock depends on your application. For information on advanced applications, see the *Technical Reference manual*.

MDR24/96 Settings

1. If you have DIO•8 cards installed, set the Tape Input and Tape Output format for each card to **ADAT**. OPT•8 cards need no configuration.
2. If the MDR24/96 is the clock master, set the **Sample Clock** to **Internal**; If the MDR24/96 is a clock slave, set the **Sample Clock** to **Word Clock** and depress the 75Ω termination button on the Sync card.
3. Set the **Sample Rate** to 44.1 kHz or 48 kHz according to your preference.

Console Settings

1. If you have DIO•8 cards installed, set the Tape Input and Tape Output format for each card to **ADAT**. OPT•8 cards need no configuration.
2. If the D8B is the clock master, set the **Sample Clock** to either **44.1 k Internal** or **48 k Internal**; if it is a clock slave, then set the **Sample Clock** to either **44.1 kHz** or **48 kHz**. Set the Sample Rate to match the **Sample Rate** selected on the MDR24/96.

ADAT Optical Hookup with DIO•8

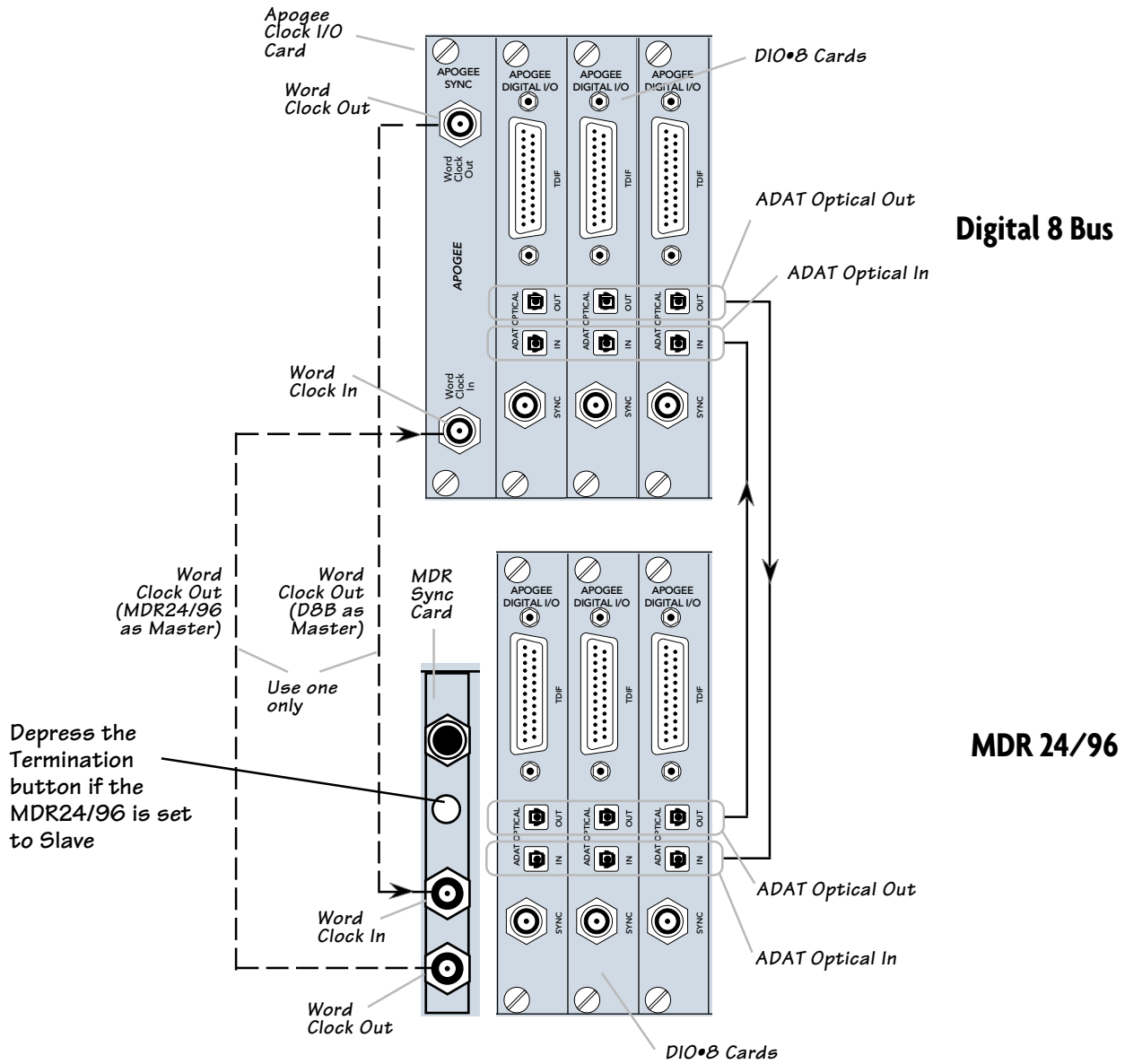

Figure 2

Digital 8 Bus

MDR 24/96

ADAT Optical Hookup with OPT•8

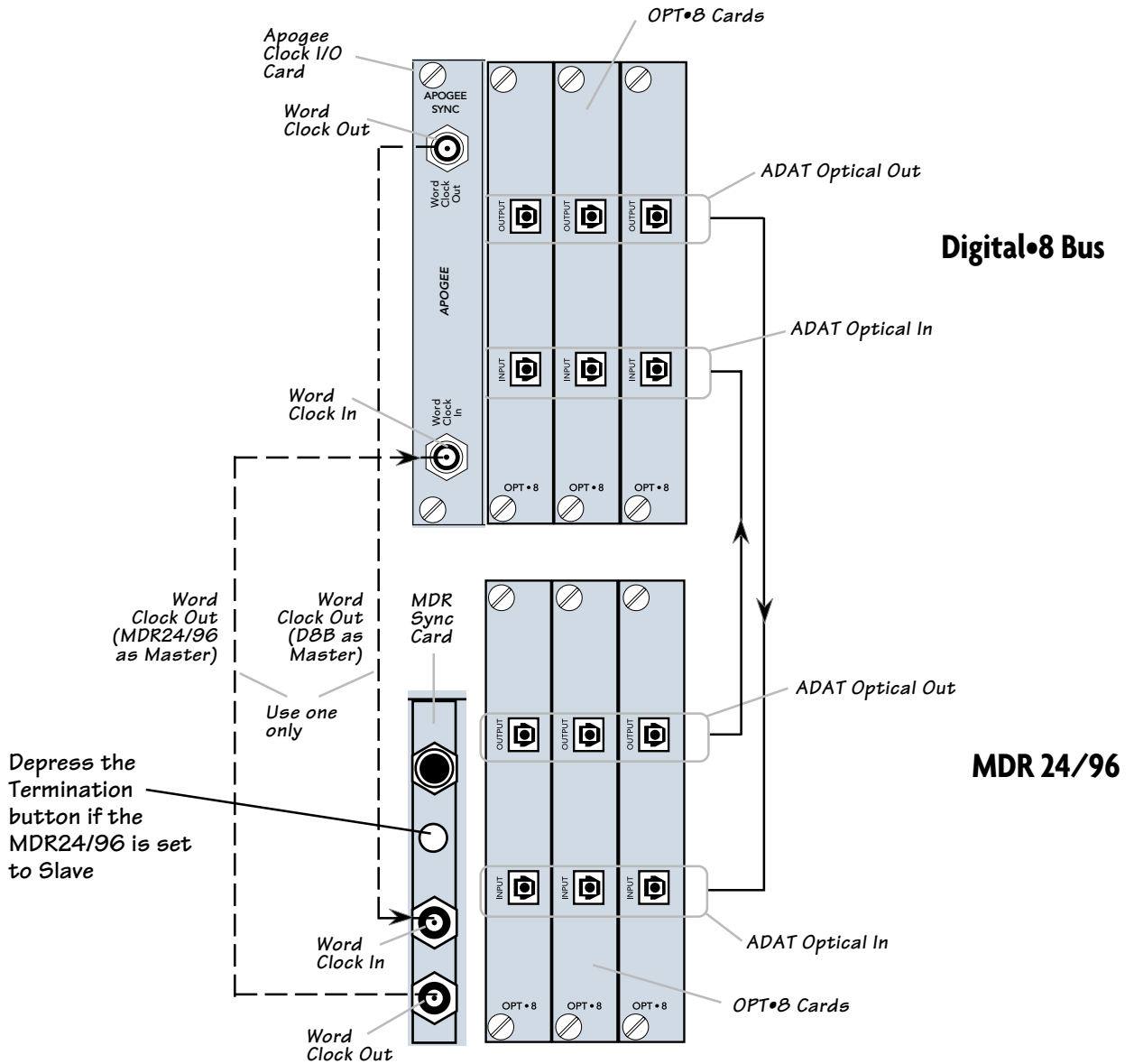

Figure 3

AES/EBU Hookup (PDI•8)

Cables & Hardware

- (3) PDI•8 cards for MDR24/96
- (3) PDI•8 cards for D8B
- (1) Clock I/O card for D8B
- (3) DB25 to DB25 AES/EBU snakes
- (1) 75Ω BNC word clock cable

Hookup

1. Connect the three AES/EBU cables between the corresponding AES/EBU connectors on the MDR24/96 and D8B.
2. When AES/EBU is used, the D8B must have a Clock I/O card installed. To make the D8B the clock master, connect its Word Clock Out to the MDR24/96 Word Clock In. To make the MDR24/96 the master, connect its Word Clock Out to the D8B Word Clock In.

MDR24/96 Settings

1. If the MDR24/96 is the clock master, set the **Sample Clock** to **Internal**; if it is a clock slave, set the **Sample Clock** to **Word Clock** and **depress the 75Ω termination switch on the Sync card**.
2. Set the **Sample Rate** to 44.1 kHz or 48 kHz according to your preference.

Console Settings

1. If the D8B is the clock master, set the **Sample Clock** to either **44.1 k Internal** or **48 k Internal**; if it is a clock slave, set the **Sample Clock** to either **44.1 kHz** or **48 kHz**. Set the sample rate to match the **Sample Rate** selected on the MDR24/96.



Note: Determining which unit in *Figure 4* provides master clock depends on your application. For information on advanced applications, see the *Technical Reference manual*.



OK, so we fibbed a little. You can use PDI•8 cards in the D8B without a Clock I/O card installed, but doing so requires that you enable sample rate conversion on both the D8B and the MDR24/96 in lieu of word clock synchronization. Sample rate conversion results in a 4-bit loss in sample resolution that may degrade the quality of the sound slightly. So, the moral of the story is that unless you just blew your wad on a new guitar and are eating peanut butter sandwiches until your next paycheck, go buy a Clock I/O card.

AES/EBU Hookup with PDI•8

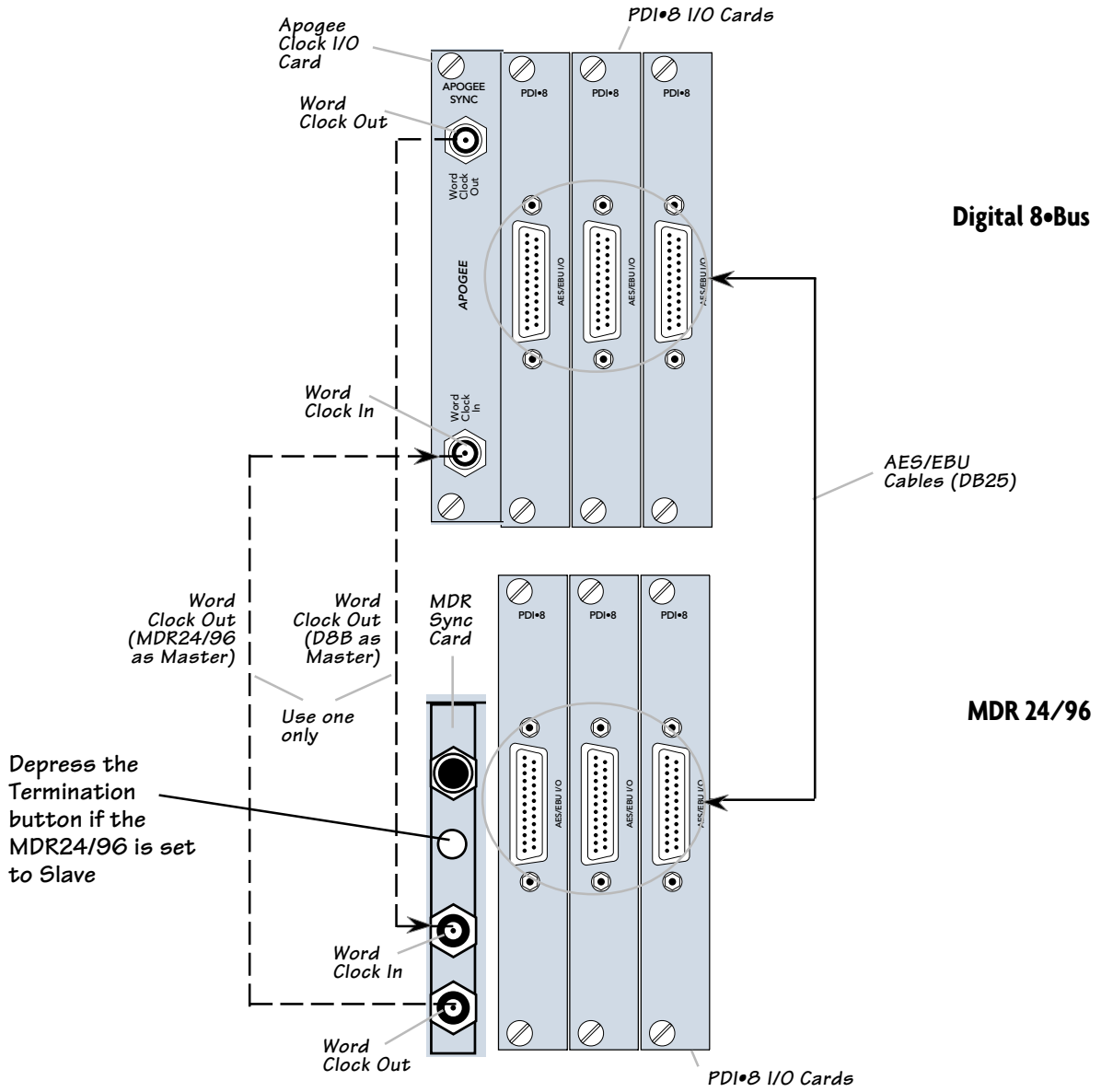

Figure 4



Note: The front panel display blanks after several minutes of being idle. Pressing any button below the display will turn it back on.

MDR24/96 Operation

Now that you've finished installing and configuring the MDR24/96, you're almost ready to start your first Project. We still want you to read this entire guide, but we already hear some of you shuffling and muttering. Okay, okay, okay... for the terminally impatient, read this chapter, then you can go out and play with your friends.

This section explains all you need to know to run a basic recording session: opening and creating Projects, operating the Transport, setting levels, and recording and overdubbing tracks. After you're done recording, you will learn how to back up your project to Mackie Media M•90 and Mackie Media PROJECT drives.

Because this section just touches on the basics of MDR24/96 operation, we strongly recommend going through the Technical Reference manual to learn about advanced MDR24/96 features like, Virtual Takes, FTP file transfer, synchronization, and more.

Opening Projects

The MDR24/96 organizes audio files and session information into folders called Projects. When the MDR24/96 boots up, it automatically opens the last Project you worked on. We've included two demonstration Projects, *Ode to Masters* and *Little Bit of Love*, to help you get familiar with the MDR24/96 right out of the box. At this point, you should see the name of the demo Project in the LCD display.

To open a Project:

1. Press **Project**. In the Project Files Menu, select **Open**.
2. Choose the drive you want to open the Project on by selecting either **Internal** or **External** from the Select Source Drive screen using the **(-)Dec / (+)Inc** or **<< / >>** buttons. The selection defaults to the drive containing the currently open Project. Press **Next**.
3. Use the **(-)Dec / (+)Inc** or the **<< / >>** buttons to select the desired Project, then select **Open**.

```
PROJECT MENU      [1]->
New  Open  Save  Delete
```

```
Select Source Drive
Internal
<<  >>          NEXT
```



Note: The front panel display blanks after several minutes of being idle. Pressing any button below the display turns back on.

Basic Transport Operations

The MDR24/96 transport and recording controls are similar to those on most multitrack tape recorders.

Play

Play puts the MDR24/96 into play from any state (as if you didn't know). **Play** also punches out of record and cancels master record standby while leaving the Transport in play.

To put the Transport into play:

- Press **Play**.

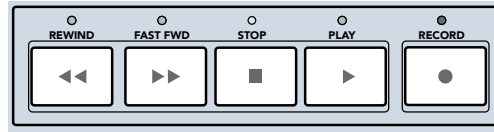

Fast Wind

Rewind and **Fast Forward** put the MDR24/96 into fast wind mode from any state. They behave just like those on a large multitrack recorder – when pressed from stop, the “tape” rolls slowly at first, then accelerates to 20X speed in a few seconds. Pressing either button a second or third time increases the winding speed still further.

To put the Transport into fast wind:

- Press **Rewind** or **Fast Forward** one, two, or three times.

Stop

Stop brings the “tape” to an immediate halt. **Stop** also punches out of record and cancels master record standby.

To stop the Transport:

- Press **Stop**.

Time Display

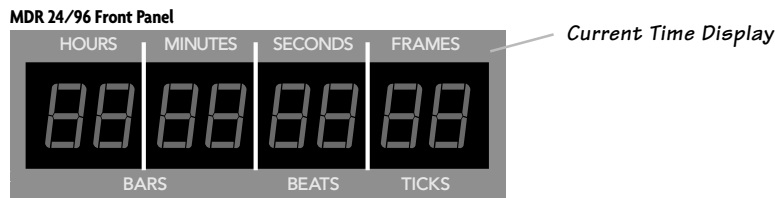

The Current Time display shows the exact position of the MDR24/96's “playback head”. Current Time is displayed in SMPTE time (HH:MM:SS:Frames).

To change the Current Time:

- Use the Transport **Play**, **Rewind**, **Fast Forward** or **Loc** buttons.

Locate Points and Looping

Locate points provide fast access to frequently used locations in your Project. The MDR24/96 has two numbered Locates (two additional numbered Locates are available when using the Remote 24 or Remote 48). Storing a Locate point saves the Current Time (Transport position) to the Locate button. Recalling a Locate causes the Transport to jump to the stored time.

To recall a Locate point:

- Press **Loc 1** or **Loc 2** to jump to that point.

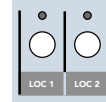

To store numbered Locate points:

Locate points can be stored either on the fly or when stopped.

1. Press **Store**. The **Store** light will blink to indicate that the MDR24/96 is ready to save a Locate point.
2. Press **Loc1** or **Loc 2** when the Transport is at the desired time; the **Store** light will go out, indicating that the point has been stored.

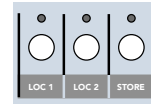

Locates 1 and 2 double as start and end points for looped playback. When looping is enabled, playback cycles between the Loop Start and Loop End points. The order of the Loop points does not matter. If Current Time is outside the Loop points when playback starts, the transport jumps to the Loop Start point; if it is between the Loop points, playback starts from Current Time.

To enable Looping:

1. Press **Loop 1-2** to enable looping.
2. Press **Play** to start loop playback.



Track Editing

The MDR24/96 features non-destructive Cut, Copy, and Paste editing. Edit operations are performed on an "Area" defined by the range of time between the Start and End points on selected track(s). Edit operations are remembered in a 999-level History List so that every edit can be undone and redone.

To perform an edit:

1. First press the **Track/Edit** button, then the button of the desired edit operation. The Record Ready LEDs change to indicate which Tracks are selected.

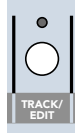

2. Press the **Record Ready** button(s) corresponding to the Track(s) you wish to edit.

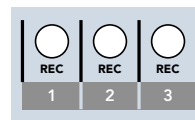

3. Press the **Start** and **End** buttons to define the range of time you wish to edit. You can set the **Start** and **End** points in any Transport State.

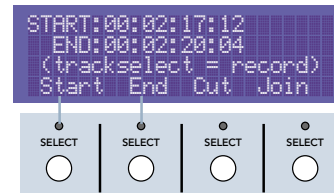

4. Press the desired edit button. You cannot execute edit operations while the Transport is moving.

5. After the edit operation, the Record Ready buttons and LEDs return to their previous state.

Cut / Join

Cut cuts a "hole" in the selected Area and copies the Area to the Clipboard. Join performs a Cut and then slides everything that occurs after the **End** point forward in time to fill the "gap" left by the Cut, exactly like splicing two ends of tape together.

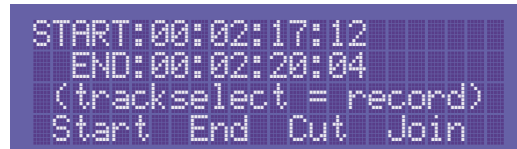

Copy

Copy copies the selected Area to the Clipboard, but leaves the Project unaffected.

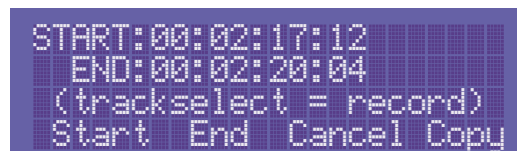

Paste / Insert

Paste copies the contents of the Clipboard Area into the Project starting at the **Start** point and first selected track. All audio in the Clipboard replaces any existing audio, and any blank space in the Clipboard leaves existing audio unaffected. Insert splits the affected Area at the **Start** point and slides the audio back in time to make a "hole" for the Clipboard. If the clipboard Area

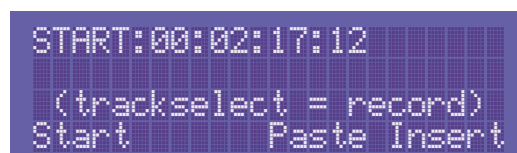

contains multiple tracks, the first track in the clipboard is placed onto the first selected Track, and the remaining Tracks in the clipboard follow in order.

Undo / Redo

Undo and Redo allow you to step forward and backwards through your editing changes. The History List number lets you keep track of your changes so that you can easily do A/B comparisons of different edits.

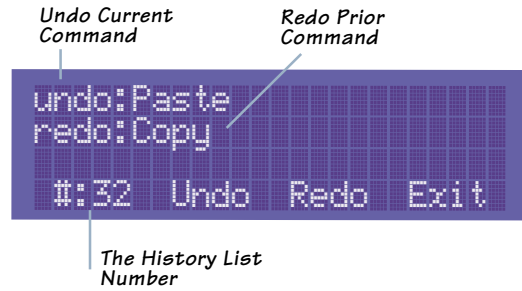

Creating Projects

Now that you have a few basics down, you're ready to start recording. First, you'll need to create a new Project. Typically a Project is a song, radio spot, or sound effects stem for a 10-minute film reel, but it could also be a live concert or an entire symphony.

To create a new Project:

1. Press **Project**, then select **New**. The MDR24/96 asks if you want to save the currently open Project. Press **No** to discard the changes you may have made to the demo Project.

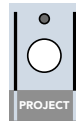

2. Choose the drive you want to create the Project on by selecting either **Internal** or **External** from the Select Destination Drive screen using the **(-)Dec / (+)Inc** or **<< / >>** buttons. The selection defaults to the drive containing the currently open Project. Press **Next**.



3. Select either **44.1/48K** or **88.2/96K** from the Sample Rate Mode screen using the **(-)Dec / (+)Inc** or **<< / >>** buttons. The Sample Rate mode determines whether your project will be a 24-track Project at 44.1 or 48 kHz, or a 12-track Project at 88.2 or 96 kHz. Once a Project is created the Sample Rate mode cannot be changed. Press **Next**.

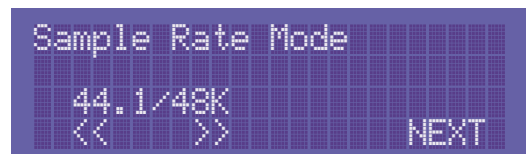

4. The name "Project#1" appears on the left side of the LCD screen. A pointer ("v") appears above the first character of the name to indicate that you can change that character. Press the **(-)Dec / (+)Inc** buttons to select the character you want in that position. Select the **>>** button to move the pointer to the next character.

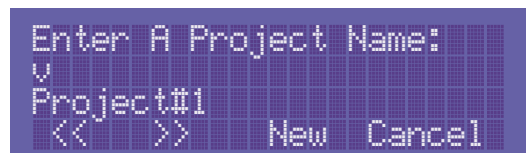

- When you've completed the Project name, select **New** to create the Project and exit.

```

PROJECT: Project#1
PLAYLIST: Playlist 1
DRIVE: C:Internal
AVAIL: 01:35:00

```

Your new project is now open; the Active Drive, Project Name, and Playlist Name are shown in the LCD display and in the GUI above the Current Time display.



In the MDR24/96 and HDR24/96, Playlists are that part of a Project that keeps track of all of your recording and editing, and controls what you hear when you hit Play. The HDR24/96 supports multiple Playlists while the MDR24/96 supports only one. If an HDR24/96 Project is played back on the MDR24/96, the MDR24/96 will play back the last Playlist saved in the HDR24/96 Project.

Monitoring

The Monitor Mode buttons determine what you hear from the MDR24/96 Tape Outputs. The MDR24/96 offers several familiar monitoring modes to facilitate rehearsal, tracking, and overdubbing.

All Input

All Input is used for rehearsal and level setting. When All Input is on, both armed and unarmed tracks monitor their inputs, and the Auto Input setting has no effect.

To enable All Input:

- Press the **All Input** button. The LED above the button when **All Input** is on.



Auto Input

Auto Input is used for recording. Auto Input affects only tracks that are in Record Ready ("armed"). Tracks that are not armed only monitor the playback of previously recorded audio. All Input overrides Auto Input. To use Auto Input, All Input must be turned off.

When Auto Input is On, armed tracks monitor their inputs in Stop, Fast Forward, Rewind, and Record. In Play, you hear only what's already recorded on the tracks. This mode is used primarily for tracking and overdubbing, where you want to hear what's been previously recorded on the track before the punch-in and after the punch-out. During the punch, you hear what is presently being recorded. Auto Input On is the default mode when you power up the MDR24/96.

When Auto Input is Off, armed tracks always monitor their inputs. This mode is used primarily for rehearsal and tracking, where you want to always hear what you're playing rather than what's already recorded on that track.

To enable Auto Input:

- Press the **Auto Input** button. The glowing LED above the button indicates that it's ON.



Metering and Setting Record Levels

A professional analog recorder has meters that indicate 0 VU at a +4 dBu nominal signal level. Generally you can record peaks 10 to 15 dB above that before distortion becomes objectionable. This 10-15 dB range above the nominal level is called “headroom”. The overload indicators on the MDR24/96 light when the signal level reaches -1 dBFS.

On digital recorder meters, zero represents the full-scale digital signal level, 0 dBFS for short. 0 dBFS is the hottest signal that a digital device can handle, with no headroom to spare. When a digital signal reaches 0 dBFS for more than a sample or two, the resulting distortion is uglier than scraping your fingernails across a chalkboard.

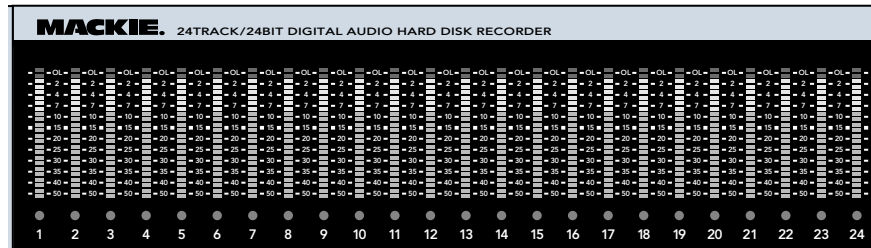

Remember, audio levels must NEVER reach 0 dBFS... never, ever, ever. Digital clipping is an extremely nasty sound that could only pass for music if you like what those crazy kids listen to over and over at all hours of the night including weekdays.

To get the best sound from the MDR24/96:

1. Turn **All Input** on.



2. Ask the talent to play or sing as loud as they will be performing during the session. While watching the MDR24/96 meters, adjust the console's tape outputs so that the signal peaks cause the red overload indicators to come on occasionally. Then, back off the tape output level slightly. This insures the best fidelity and the widest dynamic range in the recorded signal and leaves you a little headroom to accommodate the talent's enthusiasm. Keep the signal levels as high as possible without overload, because recording at lower levels reduces resolution and dynamic range. Nonetheless it is always better to be conservative and avoid the risk of overload than to try squeezing the last ounce of dynamic range from the signal.
3. Alternately, if you have a tone generator or a sound source with a constant volume (you can hold down a key on a synth), turn **All Input** on and send the tone to all 24 tracks of the console. Adjust the output levels to read 0 VU on analog consoles, or around -20 dBFS on digital consoles. If the MDR24/96 meters read -15 to -20 , you're in good shape. This leaves enough headroom for most popular music, but if you're recording acoustic music, jazz, classical, or narration, you may want to leave a little more. When the talent starts to play you may have to make some final tweaks to get everything just right.

- After adjusting the tape output levels for each console channel, follow your console manufacturer's instructions for setting the console tape return levels.



With analog I/O, a +22 dBu signal at the MDR24/96 inputs and outputs corresponds to 0 dBFS inside the MDR24/96. So, if your console has a nominal output level (0 VU) of +4 dBu, there is 18 dB of headroom before you hit the maximum record level on the MDR24/96. It also means that your console must be capable of putting out at least +22 dBu without distortion so the console doesn't clip while the recorder is still within its working range. Most professional consoles can output +22 dBu without breaking a sweat (like the Mackie Analog and Digital 8•Bus consoles). But beware that semi-pro consoles often operate at a nominal output level of -10dBV and will run out of steam before reaching a level that can take advantage of the recorder's full resolution.

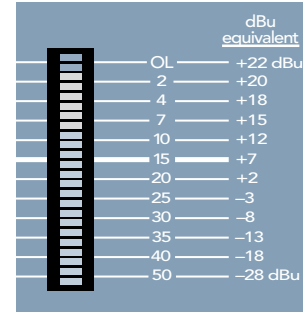

Recording

All recording in the MDR24/96 is non-destructive. When you record over existing audio, the old audio is not "erased" as it with magnetic tape; rather, new audio files are created in addition to the existing files.

Recording can only take place on tracks that are "armed" for recording.

To arm tracks for recording:

- Press a track's **Record Ready** button.
- Press it again to disarm the track.

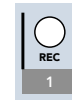

The **Record Ready** LED/button blinks when a track is armed and ready to record, and glows when the track is recording.

To record:

- Arm one or more tracks.
- Press **Play** and **Record** simultaneously.
- Press any Transport button other than **Record** to stop recording.

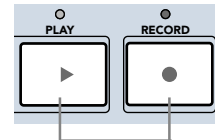

The Record LED glows when the MDR24/96 is recording and blinks when **Record** is engaged with no tracks armed (master record standby mode).

Footswitch Operation

Using a footswitch with the MDR24/96 gives you hands-free access to two of the most-used MDR24/96 functions. The footswitch is extremely handy when you want to use your hands for other tasks, like playing your instrument, working the console, or eating pizza.

Punch punches in just like pressing Play+Record and punches out like pressing Play. When playing, hitting the footswitch punches in on all armed tracks. When recording, hitting the footswitch again punches out of Record, but leaves the transport in Play.

Stop/Play toggles the MDR24/96 between Stop and Play. When the Transport is stopped, it puts it into play; when moving, it stops the Transport.

To assign the footswitch function:

1. Press the **System** button. In the System menu, select **Footswitch MDR**. Then select **Punch**, **Stop/Play** from the MDR24/96 Footswitch mode menu.
2. Select OK, and press **System** again to exit.

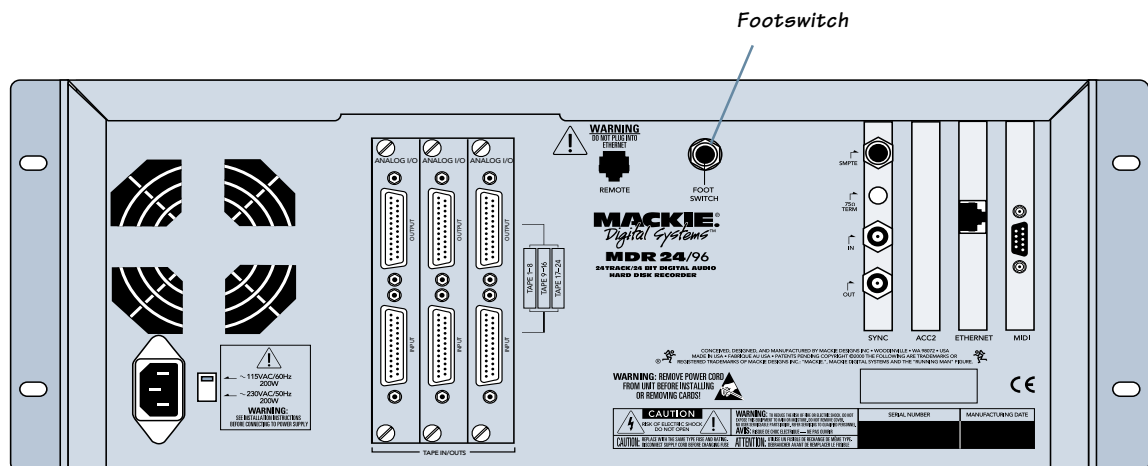

Delete Last

With the MDR24/96 you don't need to worry about filling up your hard disks with unwanted takes. The Delete Last function permanently erases all the audio files recorded during the last record pass. A recording pass consists of all punches made within one play/stop cycle. If you make edits after doing a record pass, Delete Last will have no effect.

To delete the last recording pass:

- Press the **Delete Last** button. The LCD display will ask you to confirm that you want to delete the last record pass. Press **OK**.



Alternate method:

1. Press the **Track/Edit** button and select Undo-Redo.
2. From the Undo-Redo menu select **Undo**.

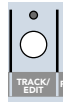

Redo Prior Command
Undo Current Command
The History List Number

Saving Projects

Every time you record new audio, the audio data and Project information is automatically saved to disk. However, if you make other changes to the Project (setting Locates, editing etc.) without recording new audio, you must save the Project for these changes to be remembered. In other words, if you quit without saving, no audio is lost, but your changes are. So once you start editing, save often.



To save the current Project:

1. Press the **Project** button.
2. From the Project menu select **Save**.
3. Press the Project or **Page Left** (<) button again to exit.

Project Backup / Restore

With Mackie Media drives, you can back up your Projects on removable media that you can hand to the client or store in your tape library. Backing up and restoring Projects is as simple as copying the Projects between the internal and the Mackie Media drives.

To copy Projects between the internal and Mackie Media drives:

1. Press the **Backup** button.



```
BACKUP SOURCE: Internal
DESTINATION: External
Set
Source Dest Exit Backup
```

2. Using the **- Dec / + Inc** or the **<< / >>** buttons, select **Set Source** to set the drive the Project will be copied from, and **Set Dest** to set the drive the Project will be copied to. Since a Project can't be copied onto itself, the Source and Destination drives must be different.

3. Select **OK** to return to the Backup menu, then select **Backup**. Choose the desired Project using the **(-) Dec / (+) Inc** or the **<< / >>** buttons.

```
Select Project to Backup
Eborall Song
<< >> OK Cancel
```

4. Press **OK**. When the backup is completed, either select another Project to back up or press the **Backup** button to exit.



It is **extremely** important that you make backup copies of your projects at the end of each session. While digital recording technology is highly reliable and hard disk media is durable, sometimes stuff just happens. To reduce your risk of catastrophic data loss (and the possible loss of \$\$ and clients), back up your projects on two media before deleting them from your working drive(s).

There.... now you know better. So, don't wait until disaster strikes to get backup religion, and don't complain to Mackie when your pet Rottweiler discovers that the only copy of your client's \$20,000 project makes a superb chew toy and buries the drive in the garden.

All media must be formatted before it can be used with the MDR24/96. Formatting erases the media's contents and prepares the file system for use with the MDR24/96. You can format media with the MDR24/96, or use existing FAT16 or FAT32-formatted media. Mackie Media M•90 drives come pre-formatted and ready to use, as do ORB disks for the Mackie Media PROJECT drive (be sure to buy IBM formatted ORB disks). Most off-the-shelf UDMA IDE drives do not come pre-formatted.

Although you can use almost any IDE drive for backup, not all UDMA IDE drives are fast enough to be used for recording and playback. If you want to use your own UDMA IDE drive for recording and playback, you must format it with the MDR24/96, then verify that it is fast enough to record and playback at the maximum data rate (24 track, 24-bit, 48 kHz). If the drive passes the performance verification test, it is permanently "tagged" as a real-time drive. If it fails, then the drive can be used for backup only. External drives that fail the record verification test will appear with an asterisk (*) in the front panel menus and dialogs.

To format and verify media performance from the MDR24/96:

1. Press the **Disk Util** button.
2. Now select **Format**. The LCD screen will display a message asking you to verify the drive speed for recording and playback.
3. Select **OK**. When the format operation has completed, another message will appear asking you to verify the drive speed for recording and playback.
4. If a UDMA drive is installed, select **OK**. After the performance verification is completed, select **Continue**. If a Mackie Media PROJECT drive is installed, select **Cancel**; they are too slow to be used for recording and playback.
5. Press **Disk Util** to exit.

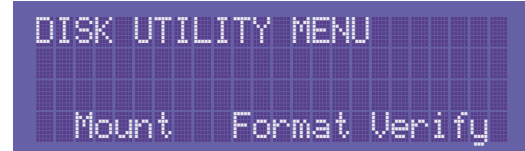

Some UDMA drives cannot keep up with the demand for 24 tracks of audio data. So, before you rush to your local computer store and buy the cheapest UDMA drive you can find, consider picking up some Mackie Media drives from your nearest Mackie dealer instead (nudge nudge, say no more...).

Purge Audio

Purge Audio permanently deletes any audio files that were recorded in the Project but are no longer used in the Playlist. Whenever you Purge Audio, the History List is cleared.

To Purge Audio from your hard drive:

1. Press the **Project** button, and then the **Page Right (>)** to the second Project menu page.
2. From the Project Menu select Purge Audio.
3. Press **OK** to confirm the operation.

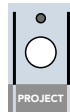

There! You're all boned up on the MDR24/96, so put down this booklet and get to work ... or play. Thanks for reading this guide. If questions have gone unanswered, check the MDR24/96 Technical Reference Manual or Mackie's website www.mackie.com. Enjoy!



Appendix A: Compatible Cables

Analog and Digital Multitrack Cables

The following companies supply analog and digital multitrack cables for use with the MDR24/96 I/O cards:

Horizon Music, Inc.

P.O. Box 1988, Cape Girardeau MO 63702-1988
Tel: (800) 255-9822; Fax: (800) 455-3460
<http://www.horizonmusic.com>

AIO•8 Analog Interface Cables

HDA8 Series DB25 to [specify connector]
Connector options: 8 male XLR, 8 female XLR, or 8 1/4" TRS
Standard lengths: 5, 10, 15, 20, 25 feet

DIO•8 TDIF Interface Cables

TDIF Series DB25 to DB25
Standard lengths: 5, 10, 15 feet

PDI•8 AES/EBU Interface Cables

HD44 Series DB25 to [specify connector]
Connector options: 4 male + 4 female XLR, or DB25
Standard lengths: 5, 10, 15, 20, 25 feet

Hosa Technology, Inc.

6920 Hermosa Circle, Buena Park CA 90620
Tel: (714) 736-9270; Fax (714) 522-4540
<http://www.hosatech.com>

AIO•8 Analog Interface Cables

DTP Series DB25 to 8 1/4" TRS
DTF Series DB25 to 8 female XLR's
DTM Series DB25 to 8 male XLR's
Standard lengths: 3, 4, 5, 7 meters

DIO•8 TDIF Interface Cables

DBK Series DB25 to DB25
Standard lengths: 3, 15 feet

OPT•8 / DIO•8 ADAT Optical Interface Cables

OPT Series Standard ADAT Optical cables
OPM Series Jacketed ADAT Optical cables w/ metal headshell
OPT lengths: 2, 3, 6, 10, 13, 17, 30, 50 feet
OPM lengths: 3, 5, 10, 15, 20, 30, 50 feet

PDI•8 AES/EBU Interface Cables

DBK Series DB25 to 4 male, 4 female XLR's
Standard length: 8 meters only

Marshall Electronics

PO Box 2027, Culver City, CA 90231
 Tel: (800) 800-6608; Fax: (310) 391-8926
<http://www.mars-cam.com/cable.html>

AIO•8 Analog Interface Cables

DC-DAXM Series	DB25 to 8 male XLR's
DC-DAXF Series	DB25 to 8 female XLR's
DC-DAS Series	DB25 to 8 1/4" TRS connectors
Standard lengths:	3, 5, 10, 15, 20, 25 feet

DIO•8 TDIF Interface Cables

DCD-88D Series	DB25 to DB25.
Standard lengths:	1, 3, 6, 12, 15, 20, 25, 33 feet.

PDI•8 AES/EBU Interface Cables

DC-SYX Series	DB25 to 4 male, 4 female XLR's
DC-DUB Series	DB25 to DB25
Standard lengths:	3, 5, 10, 15, 20, 25 feet

Pro Co Sound, Inc.

135 E. Kalamazoo Ave., Kalamazoo, MI 49007
 Tel: (800) 253-7360; Fax: (616) 388-9681
<http://www.procosound.com>

AIO•8 Analog Interface Cables

DA-88 XM Series	DB25 to 8 male XLR's
DA-88 XF Series	DB25 to 8 female XLR's
DA-88 BQ Series	DB25 to 8 1/4" TRS connectors
Standard lengths:	5, 10, 15, 20 feet

Other Cables

In addition to the companies listed above, the following companies supply individual 110Ω AES/EBU and/or 75Ω word clock and video cables:

Apogee Electronics Corporation

3145 Donald Douglas Loop South
 Santa Monica, CA 90405-3210
 Tel: (310) 915-1000; Fax: (310) 391-6262
<http://www.apogeedigital.com>

Canare

531 5th Street, Unit A, San Fernando, CA 91340
 Tel: (818) 365-2446; Fax: (818) 365-0479
<http://www.canare.com>

Whirlwind

99 Ling Rd., Rochester, NY 14612
 Tel: (888) 733-4396; Fax: (716) 865-8930
<http://www.whirlwindusa.com>

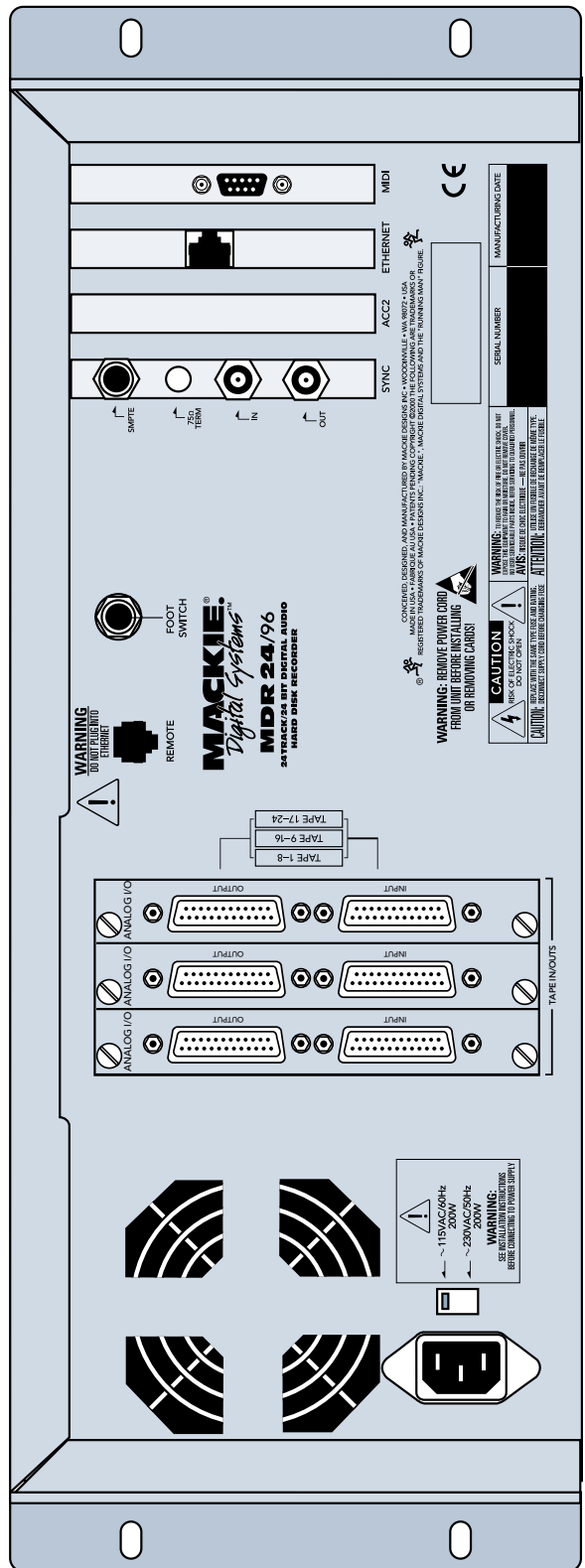
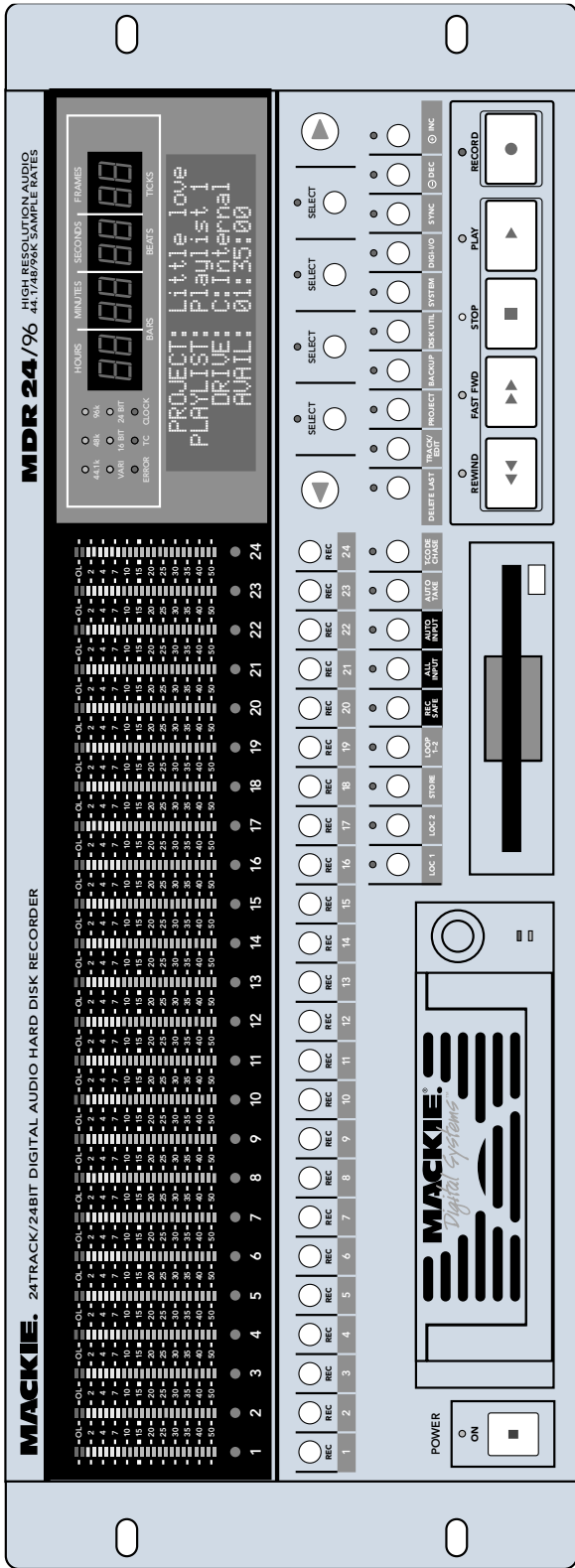

Quick Start Guide

Troubleshooting and service

Although you probably won't need them, troubleshooting tips can be found in the Technical Reference Manual. Technical support is available by contacting your Mackie dealer, calling Mackie Designs at (800) 258-6883 (8:00 AM to 5:00 PM Pacific Time), or visiting Mackie's website at www.mackie.com.

Please read the included warranty information, then complete and return the included Warranty Registration card, or it's straight to bed for you with no dinner.

Colophon

Quick Start Guide text composed by Dana Bourke, based on a ballet by Jeff Gilbert. It was made possible by the teachings and donations of the MDR24/96 Design Team, most notably Brian McCully and Bob Tudor. Graphics and layout were performed by Tony "Waldog" Baird with technical support from Steve Eborall and Frank "Weasel Boy" Heller. Cover art courtesy of Bryan Tiller. Long-winded explanations, editing, and last minute updates from Mike Rivers, with proofreading and final blessing by Jeff Gilbert. Proofreading and additional editing by Linn Compton. Scott Garside was a pain the whole time.

Demo Music Credits

Ode to Masters

Written by:	Jay Roberts and Rick Reid
Published By:	Nigel Nose Music
Electric Guitar:	Jay Roberts
Classical Guitar:	Rick Reid
Bass:	Dan Dean
Drums:	Brendan Scanlan
Hammond B3:	Joey DeFrancesco
Trumpet:	Joey DeFrancesco

Little Bit of Love

Written by:	Claude Gaudette & Alan Roy Scott BMI #877477
Published by:	KYUSHU BOY MUSIC BMI #231306319
Artist:	Shirley Meyers
Production Company:	Leggett Music Inc. Nashville Tn.
Produced by:	Keith Olsen
Arranged by:	Claude Gaudette and Keith Olsen
Keyboards:	Claude Gaudette, Richard Baker
Guitars:	Tim Pierce
Engineered by:	Keith Olsen and Peter Love
Recorded and Programmed at	Goodnight LA Studios, Los Angeles

"Mackie," the "Running Man" figure, "MDR24/96," and "Digital 8•Bus" are trademarks or registered trademarks of Mackie Designs Inc. All other brand names mentioned are trademarks or registered trademarks of their respective holders, and are hereby acknowledged.

MACKIE®
Digital Systems

© 2001 Mackie Designs Inc.
 All Rights Reserved.
 Printed in the U.S.A.



Notes

Lined area for taking notes.



Free Manuals Download Website

<http://myh66.com>

<http://usermanuals.us>

<http://www.somanuals.com>

<http://www.4manuals.cc>

<http://www.manual-lib.com>

<http://www.404manual.com>

<http://www.luxmanual.com>

<http://aubethermostatmanual.com>

Golf course search by state

<http://golfingnear.com>

Email search by domain

<http://emailbydomain.com>

Auto manuals search

<http://auto.somanuals.com>

TV manuals search

<http://tv.somanuals.com>